



blumfeldt

## Urban Bamboo

Indoor Garden  
Jardín interior  
Jardin intérieur  
Giardino interno

10033199





**Sehr geehrter Kunde,**

wir gratulieren Ihnen zum Erwerb Ihres Gerätes. Lesen Sie die folgenden Hinweise sorgfältig durch und befolgen Sie diese, um möglichen Schäden vorzubeugen. Für Schäden, die durch Missachtung der Hinweise und unsachgemäßen Gebrauch entstehen, übernehmen wir keine Haftung. Scannen Sie den folgenden QR-Code, um Zugriff auf die aktuellste Bedienungsanleitung und weitere Informationen rund um das Produkt zu erhalten:



---

## INHALTSVERZEICHNIS

---

Sicherheitshinweise 4  
 Lieferumfang 5  
 Zusammenbau 6  
 Bepflanzung und Aufzucht 10  
 Hinweise zur Entsorgung 15

**English 17**  
**Español 31**  
**Français 45**  
**Italiano 59**

---

## TECHNISCHE DATEN

---

Artikelnummer	10033199
Stromversorgung	220-240 V ~ 50/60 Hz
Wassertankkapazität	7 L

---

## KONFORMITÄTSERKLÄRUNG

---

**Hersteller:**

Chal-Tec GmbH, Wallstraße 16, 10179 Berlin,  
 Deutschland.



**Dieses Produkt entspricht den folgenden  
 Europäischen Richtlinien:**

2014/30/EU (EMV)  
 2014/35/EU (LVD)  
 2011/65/EU (RoHS)

---

## SICHERHEITSHINWEISE

---

- Verwenden Sie für die Bepflanzung Leitungswasser. Schließen Sie den Strom erst an, wenn der Tank voll ist.
- Wenn das Licht eingeschaltet ist, schauen Sie niemals direkt hinein, um Schäden an Ihren Augen zu vermeiden.
- Halten Sie die Oberfläche der Lampen sauber, um eine optimale Lichtwirkung zu gewährleisten. Verwenden Sie zur Reinigung der Leuchtmittel ein weiches Tuch.
- Reinigen Sie die Leuchtmittel niemals mit chemischen Mittel, Alkohol und Benzin, da sich die Lampen sonst verfärben oder beschädigt werden können.
- Ziehen Sie den Stecker aus der Steckdose, wenn Sie der Gerät nicht länger zur Bepflanzung nutzen.
- Stellen Sie das Gerät nicht in einer brennbaren, explosiven oder feuchten Umgebung auf.
- Stellen Sie das Gerät auf eine ebene, stabile Oberfläche.
- Falls das Gerät Fehlfunktionen aufweist, schalten Sie sofort die Stromversorgung aus und wenden Sie sich zur Prüfung und Reparatur an einen Fachbetrieb.
- Falls das Netzkabel oder der Stecker beschädigt sind, müssen sie vom Hersteller, einem autorisierten Fachbetrieb oder einer ähnlich qualifizierten Person ersetzt werden.
- Das Gerät enthält Teile, die dem Benutzer nicht zugänglich sind. Reparaturen dürfen nur von qualifizierten Fachkräften durchgeführt werden.

## LIEFERUMFANG

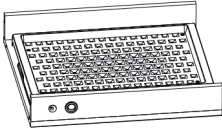
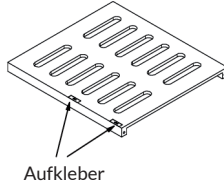
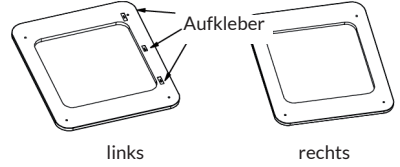
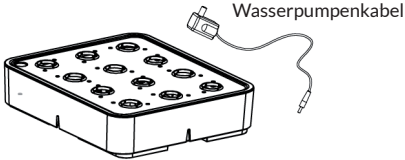
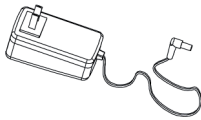
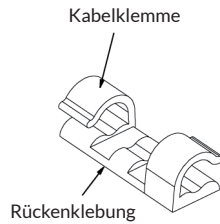
**1 Oberplatte (x1)****2 Basisplatte (x2)****3 Seitenplatten (x2)****4 Tank (inkl. Deckel und Wasserpumpe)****5 Pflanzkörbe (x12)****6 Pflanz-Schwamm (x12)****7 Netzteil (x1)****8 Kleinteile**

Kabelklemmen (x5)



Sechskantschrauben (x8)

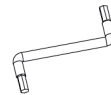

Innensechskantschlüssel (x1)

## ZUSAMMENBAU

### Schritt 1: Zusammenbau des Holzrahmens

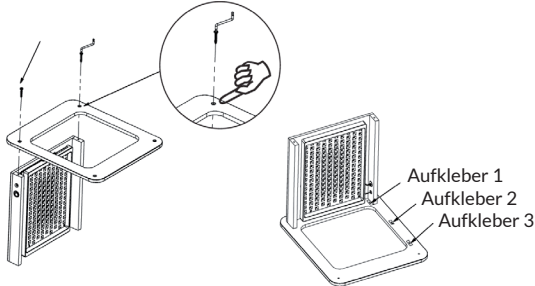
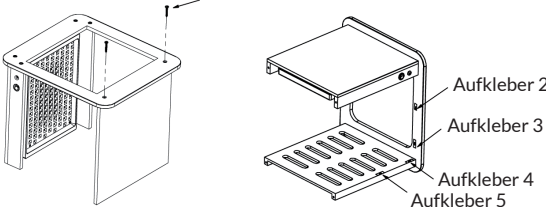
1	Nehmen Sie alle Teile aus der Verpackung und prüfen Sie, ob Teile fehlen oder beschädigt sind.
2	<p>Legen Sie die Oberplatte auf einen weichen Untergrund. Befestigen Sie die Seitenplatte mit den 3 Aufklebern mit Schrauben an der Oberplatte. Benutzen Sie zur Befestigung den Innensechskantschlüssel.</p> 
3	<p>Befestigen Sie eine der Basisplatten mit Schrauben an der Seitenplatte. Achten Sie darauf, dass der Aufkleber an der Basisplatte zu der Seite zeigt, zu der auch die Aufkleber der Seitenplatte zeigen.</p> 

Befestigen Sie dann die zweite Seitenplatte mit Schrauben am Rahmen.

4

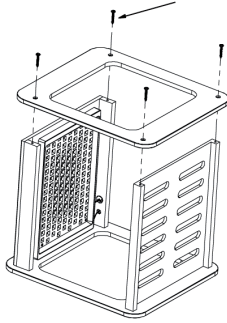

### Schritt 2: Befestigung der Kabelklemmen und des Pumpenkabels

Entfernen Sie Aufkleber 1 und kleben Sie die Rückseite der Kabelklemme an die Stelle, wo sich der Aufkleber befand.

1

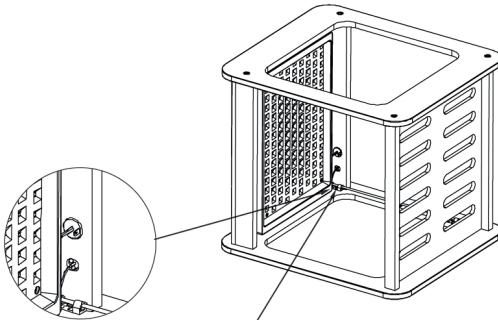

Kabelklemme 1

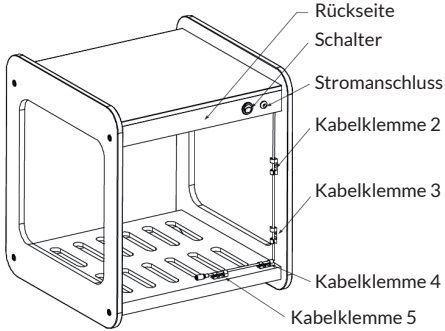
<b>2</b>	Wiederholen Sie diesen Vorgang, indem Sie Aufkleber 2 und 3 an der Seitenplatte entfernen und Kabelklemmen an den Stellen der Aufkleber befestigen.
<b>3</b>	Wiederholen Sie diesen Vorgang, indem Sie Aufkleber 4 und 5 an der Basisplatte entfernen und Kabelklemmen an den Stellen der Aufkleber befestigen.
<b>4</b>	<p>Befestigen Sie das Wasserpumpen-Verlängerungskabel an den 5 Kabelklemmen.</p>  <p>The diagram shows a rectangular metal frame with a perforated base. On the right side, there is a vertical panel with a switch and a power outlet. Five cable terminals are labeled: Kabelklemme 2, Kabelklemme 3, Kabelklemme 4, and Kabelklemme 5. The back of the unit is labeled 'Rückseite'.</p>

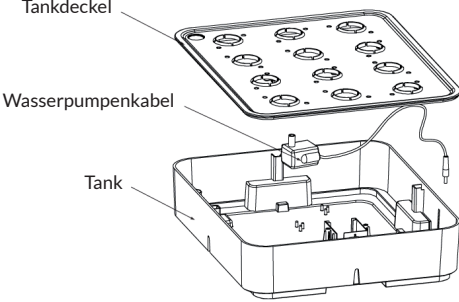
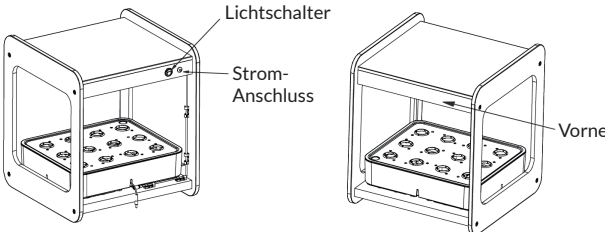

### Schritt 3: Installation des Tanks

<p><b>1</b></p>	<p>Nehmen Sie den Tankdeckel ab und geben Sie Wasser und eine Nährstofflösung in den Tank. Detaillierte Informationen zur Konzentration der Nährlösung finden Sie im Kapitel BEPFLANZUNG UND AUFZUCHT.</p> 
<p><b>2</b></p>	<p>Setzen Sie den Tank (Wasserpumpenkabel und Wasserpumpen-Verlängerungskabel sind auf der selben Seite) auf die Basisplatte im Rahmen und verbinden Sie das Wasserpumpenkabel mit dem Verlängerungskabel.</p>
<p><b>3</b></p>	<p>Der Lichtschalter befindet sich auf der Rückseite des Geräts und dient dem Ein- und Ausschalten des LED-Pflanzlichts.</p>
<p><b>4</b></p>	<p>Schließen Sie das Netzteil und beginnen Sie mit der Bepflanzung.</p> 

## Hinweis zum Smart-Control-System

	<ul style="list-style-type: none"> <li>• Wenn der Schalter auf (O) geschaltet wird, erlischt die Pflanzenbeleuchtung für längere Zeit. Wenn der Schalter auf (I) geschaltet wird, wird die Pflanzenbeleuchtung eingeschaltet und der Timer gestartet. Das Pflanzenlicht schaltet sich nach 14 Stunden automatisch aus und nach 10 Stunden automatisch wieder ein.</li> <li>• Die Wasserpumpe ist abwechselnd für 15 Minuten ein- und ausgeschaltet. Nach dem automatischen Ausschalten der Anlagenbeleuchtung bleibt die Wasserpumpe im eingeschalteten Zustand und arbeitet weiter.</li> </ul>
---	---

## BEPFLANZUNG UND AUFZUCHT

### Tipps zur Bepflanzung

- Bitte kaufen Sie Saatgut und Nährlösungen bei Ihnen vor Ort, beispielsweise im Bau- oder Pflanzenmarkt.
- Pflanz-Schwämme, Saatgut und Nährlösungen sind Einwegprodukte, die nicht wiederverwendet werden können. Bitte füllen Sie rechtzeitig die für die Bepflanzung notwendigen Produkte wieder auf.
- Benutzen Sie, falls möglich, gefiltertes und gereinigtes Wasser.

### Schritt 1: Vorbereitung der Nährlösung

1	Besorgen Sie sich Nährstoffkonzentrat und verdünnen Sie es, wie auf der Verpackung angegeben mit Wasser.
2	<p>Füllen Sie sauberes, frisches Wasser bis zur MAX-Markierung in den Tank. Oberhalb der MAX-Markierung muss 1,5 cm Platz zum Rand bleiben.</p> 

## Schritt 2: Bepflanzung

### (A) Bepflanzung mit Samen

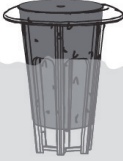
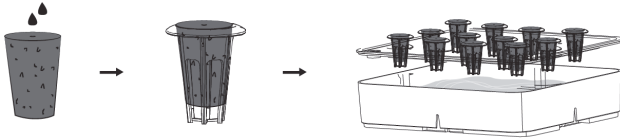
1	Setzen Sie den Pflanz-Schwamm in den Pflanzkorb.	 <p data-bbox="692 256 799 384">Der Boden des Pflanzkorbs befindet sich im Wasser</p>
2	Stecken Sie 2-3 Samen in den Pflanz-Schwamm.	
3	Setzen Sie die Pflanzkörbe in die Löcher des Tankdeckels ein.	
4	Setzen Sie den Tank in den Rahmen ein und versichern Sie sich, dass die Böden der Pflanzkörbe das Wasser berühren.	
5	Schalten Sie das Gerät und die Lampe ein.	
6	Wählen Sie nach 3-7 Tagen jeweils den stärksten Spross pro Pflanzkorb zur weiteren Aufzucht aus und entsorgen Sie die anderen Keimlinge.	
		

(B) Bepflanzung mit gekauften Setzlingen

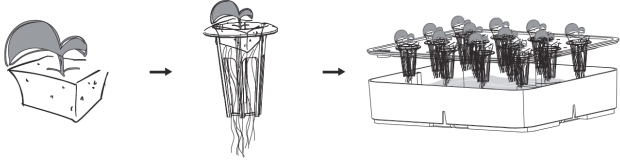
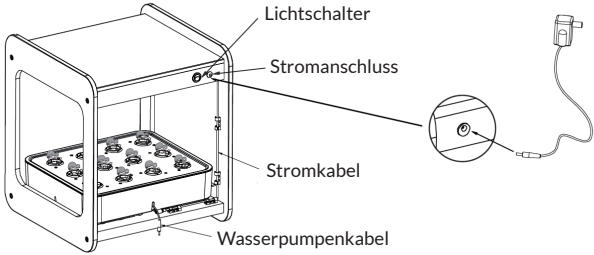
1	Setzen Sie die Setzlinge in die Pflanzkörbe. Achten Sie darauf, die Wurzeln der Setzlinge dabei nicht zu beschädigen.
2	Setzen Sie die Pflanzkörbe in die Löcher des Tankdeckels ein.
3	Setzen Sie den Tank in den Rahmen ein und versichern Sie sich, dass die Böden der Pflanzkörbe das Wasser berühren.
4	<p>Schalten Sie das Gerät und das Licht ein.</p> 
	

### Schritt 3: Aufzucht und Pflege

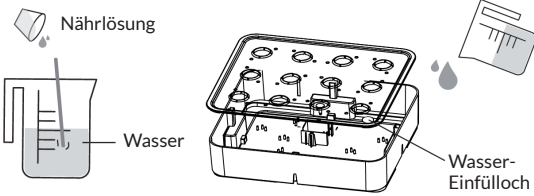
1	Wenn Sie welke Blätter entdecken, öffnen Sie den Tankdeckel und überprüfen Sie den Wasserstand. Prüfen Sie mindestens einmal pro Woche den Wasserstand und die Wurzeln.
2	Rühren Sie regelmäßig neue Nährlösung in einem Messbecher an.
3	<p>Geben Sie die Nährlösung in den Tank.</p>  <p>Das Diagramm zeigt den Prozess der Nährstoffzufuhr. Links ist ein Messbecher mit Wasser und einer Zugabe von Nährlösung dargestellt. Rechts ist der Tank mit dem Wasser-Einfüllloch, in das die Nährlösung gegeben wird.</p>

**Hinweis:** Der Wasserstand des Tanks darf nicht unterhalb der Wasserpumpe liegen, da das Produkt sonst einen Alarm auslöst.

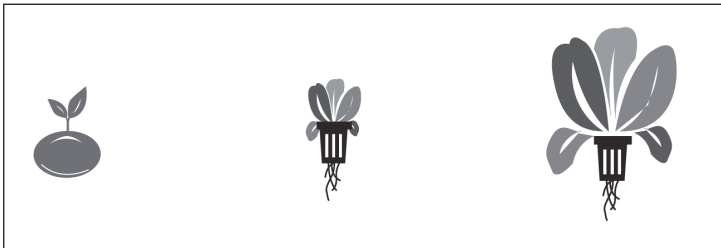

### Schritt 4: Vom Spross zur Ernte

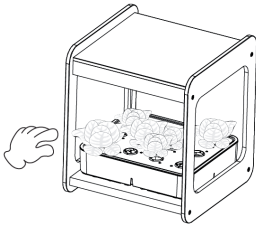
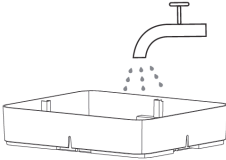

## Schritt 5: Ernte und Reinigung

<b>1</b>	Sobald die Pflanzen reif sind, ernten Sie sie.
<b>2</b>	Wenn alle Pflanzen geerntet wurden, reinigen Sie den Tank, den Tankdeckel und die Pflanzkörbe.
<b>3</b>	<p>Falls Sie erstmal keine weiteren Pflanzen anbauen, trennen Sie das Gerät vom Stromnetz.</p> <div style="display: flex; justify-content: space-around; align-items: center;">   </div>

## Wachstumsdauer

Keimungsphase	3-7 Tage		Wachstumsdauer von Blattgemüse: 25-40 Tage
Sämlingsstadium	7-15 Tage		Wachstumsdauer von Blumen: 25-40 Tage
Wachstumsperiode	25-30 Tage		Wachstumsdauer von Obst/ Gemüse: 25-40 Tage

## Einfluss der Umgebungstemperatur auf den Anbau

20-28 °C Normaler Wachstum	$\leq 15$ °C Verlangsamter Wachstum	$\geq 35$ °C Wurzelfäule
-------------------------------	--	-----------------------------

---

## HINWEISE ZUR ENTSORGUNG

---



Befindet sich die linke Abbildung (durchgestrichene Mülltonne auf Rädern) auf dem Produkt, gilt die Europäische Richtlinie 2012/19/EU. Diese Produkte dürfen nicht mit dem normalen Hausmüll entsorgt werden. Informieren Sie sich über die örtlichen Regelungen zur getrennten Sammlung elektrischer und elektronischer Gerätschaften. Richten Sie sich nach den örtlichen Regelungen und entsorgen Sie Altgeräte nicht über den Hausmüll. Durch die regelkonforme Entsorgung der Altgeräte werden Umwelt und die Gesundheit ihrer Mitmenschen vor möglichen negativen Konsequenzen geschützt. Materialrecycling hilft, den Verbrauch von Rohstoffen zu verringern.





**Dear Customer,**

Congratulations on purchasing this equipment. Please read this manual carefully and take care of the following hints to avoid damages. Any failure caused by ignoring the items and cautions mentioned in the instruction manual is not covered by our warranty and any liability. Scan the QR code to get access to the latest user manual and other information about the product



---

## CONTENT

---

Safety Instructions 18  
 Packing Content 19  
 Assembly 20  
 Planting and Growing 24  
 Hints on Disposal 29

---

## TECHNICAL DATA

---

Item number	10033199
Power supply	220-240 V ~ 50/60 Hz
Water tank capacity	7 L

---

## DECLARATION OF CONFORMITY

---

**Producer:**

Chal-Tec GmbH, Wallstraße 16, 10179 Berlin,  
 Germany.

**This product is conform to the following European Directives:**

2014/30/EU (EMC)  
 2014/35/EU (LVD)  
 2011/65/EU (RoHS)

---

## SAFETY INSTRUCTIONS

---

- Use tap water for planting. Do not connect the power until the tank is full.
- When the light is on, never look directly into it to prevent damage to your eyes.
- Keep the surface of the lamps clean to ensure optimum lighting effects. Use a soft cloth to clean the lampshades.
- Never clean the lampshades with chemicals, alcohol or petrol, as this can discolour or damage the lamps.
- Disconnect the plug from the socket if you no longer use the device for planting.
- Do not install the unit in a flammable, explosive or humid environment.
- Place the unit on a level, stable surface.
- If the device malfunctions, immediately switch off the power supply and contact a specialist company for inspection and repair.
- If the power cord or plug is damaged, it must be replaced by the manufacturer, an authorized service center or a similarly qualified person.
- The device contains parts that are not accessible to the user. Repairs may only be carried out by qualified specialists.

# PACKING CONTENT

## 1 Top plate (x1)

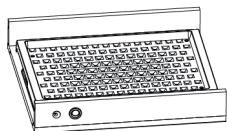

## 2 Base plate (x2)

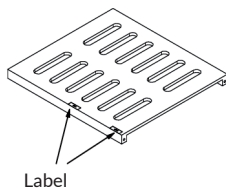

## 3 Lateral plates (x2)

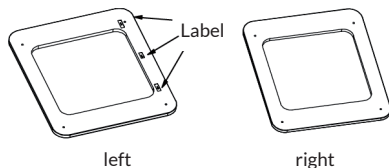

## 4 Tank (with tank lid and water pump)

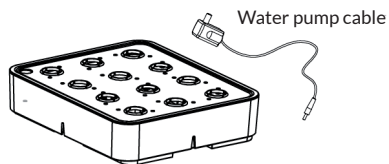

## 5 Plant baskets (x12)



## 6 Foam (x12)



## 7 Power adapter (x1)

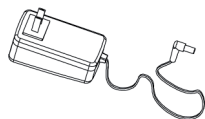

## 8 Hardware

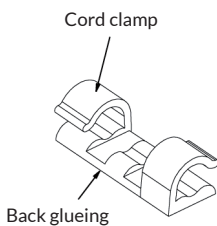

Cord clamps (x5)



Inner hexagonal screw (x8)

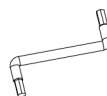

Allen key (x1)

## ASSEMBLY

### Step 1: Installation of the wooden support

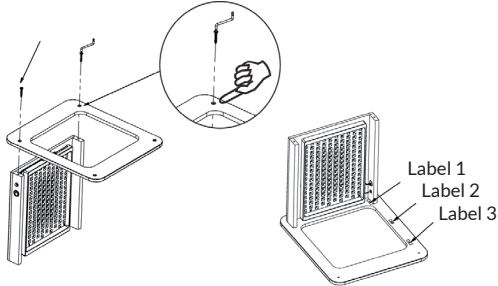
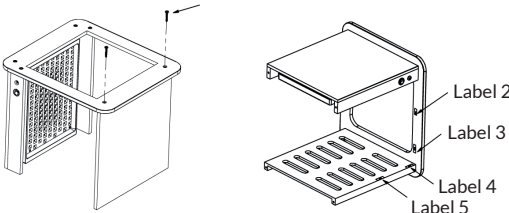
1	<p>Remove all parts from their packaging and check for missing or damaged parts.</p>
2	<p>Place the top plate on a soft surface. Fasten the side plate to the top plate with the 3 plates with screws. Use the Allen key for fastening.</p> 
3	<p>Fasten one of the base plates to the side plate with screws. Make sure that the label on the base plate points to the side to which the labels on the side plate also point.</p> 

Then fasten the second side plate to the frame with screws.

4

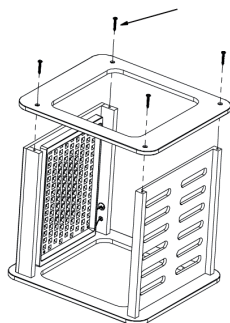

### Step 2: Install the cord clamp and the water pump extension cord

Remove sticker 1 and stick the back of the cable clamp to where the sticker was.

1

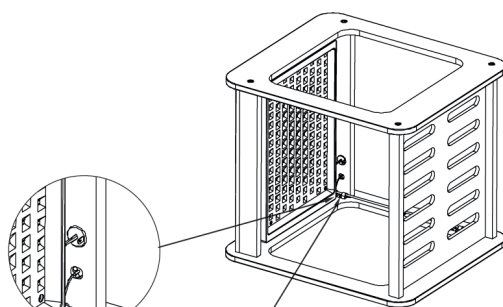

Cord clamp 1

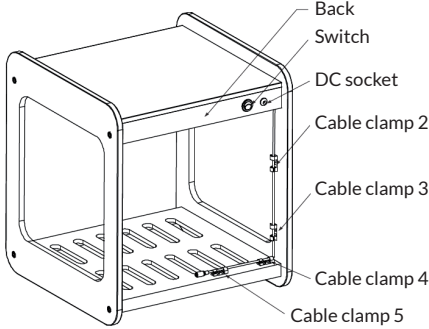
2	Repeat this process by removing labels 2 and 3 on the side panel and attaching cable clamps to the locations of the labels.
3	Repeat this process by removing labels 4 and 5 from the base plate and attaching cable clamps to the locations on the labels.
4	Attach the water pump extension cable to the 5 cable clamps.
	 <p>The diagram shows a perspective view of a rectangular enclosure with a perforated base. On the right side panel, there is a DC socket and a switch. Five cable clamps are attached to the enclosure: Cable clamp 2 is on the side panel near the DC socket; Cable clamp 3 is on the side panel near the switch; Cable clamp 4 is on the base plate; Cable clamp 5 is on the base plate. Labels 2, 3, 4, and 5 are indicated by lines pointing to the locations where the clamps are attached.</p>

### Step 3: Installation and use of tank:

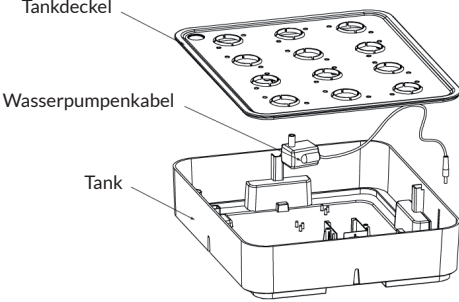
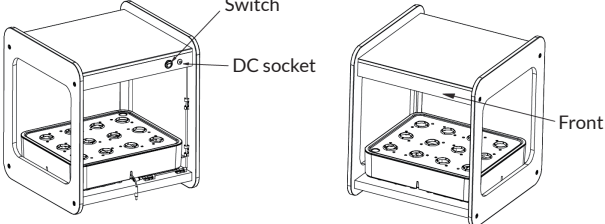
<p><b>1</b></p>	<p>Remove the tank cap and add water and nutrient solution to the tank. Detailed information on the concentration of the nutrient solution can be found in the chapter PLANTING AND GROWING.</p>  <p>Tankdeckel</p> <p>Wasserpumpenkabel</p> <p>Tank</p>
<p><b>2</b></p>	<p>Place the tank (water pump cable and water pump extension cable are on the same side) on the base plate in the frame and connect the water pump cable to the extension cable.</p>
<p><b>3</b></p>	<p>The light switch is located on the back of the unit and is used to switch the LED plant light on and off.</p>
<p><b>4</b></p>	<p>Close the power supply and start planting.</p>  <p>Switch</p> <p>DC socket</p> <p>Front</p>

## Notes on the Smart Control System

	<ul style="list-style-type: none"> <li>• When the switch is set to (O), the plant lighting goes out for a long time. When the switch is set to (I), the plant lighting is switched on and the timer starts. The plant light switches off automatically after 14 hours and switches on again automatically after 10 hours.</li> <li>• The water pump is alternately switched on and off for 15 minutes. After the system lighting is automatically switched off, the water pump remains switched on and continues to operate.</li> </ul>
---	---

## PLANTING AND GROWING

### Tips for planting

- Please buy seeds and nutrient solutions on site, for example at the DIY or plant market.
- Seedling foams, seeds and nutrient solutions are disposable products that cannot be reused. Please replenish the products necessary for planting in good time.
- If possible, use filtered and purified water.

### Step 1: Preparing the nutrient solution

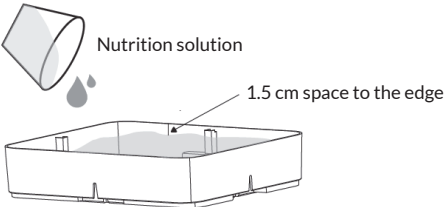
1	Get nutrient concentrate and dilute with water as indicated on the package.
2	<p>Fill the tank with clean, fresh water to the MAX mark. Above the MAX mark there must be 1.5 cm space to the edge.</p> 



## Step 2: Planting

### (A) Seed planting

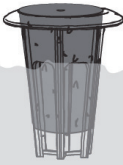
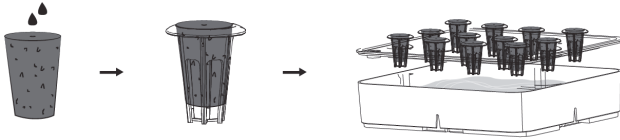
1	Place the seedling foam in the planting basket.	 <p data-bbox="692 256 788 384">The bottom of the planting basket is in the water</p>
2	Put 2-3 seeds into the seedling foam.	
3	Insert the plant baskets into the holes in the tank cap.	
4	Place the tank in the frame and make sure that the bottoms of the plant baskets touch the water.	
5	Turn on the unit and the lamp.	
6	After 3-7 days, select the strongest shoot per planting basket for further cultivation and dispose of the other seedlings.	
		

## (B) Planting with purchased seedlings

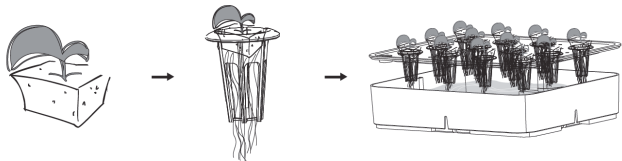
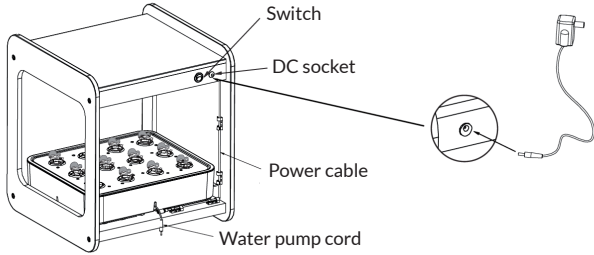
1	Place the seedlings in the planting baskets. Take care not to damage the roots of the seedlings.
2	Insert the baskets into the holes in the tank cap.
3	Place the tank in the frame and make sure that the bottoms of the plant baskets touch the water.
4	<p>Switch on the device and the light.</p> 
	 <p>Switch</p> <p>DC socket</p> <p>Power cable</p> <p>Water pump cord</p>

### Step 3: Cultivation and care

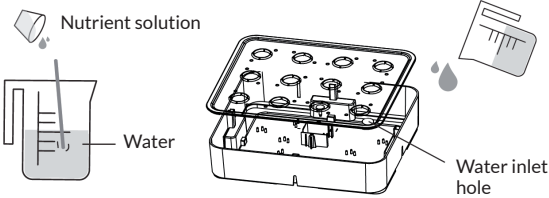
1	When withered leaves are detected, open the tank cap and check the water level. Check the water level and roots at least once a week.
2	Stir new nutrient solution regularly in a measuring cup.
3	<p>Add the nutrient solution to the tank.</p> 

**Note:** The water level of the tank must not be below the water pump, otherwise the product will trigger an alarm.

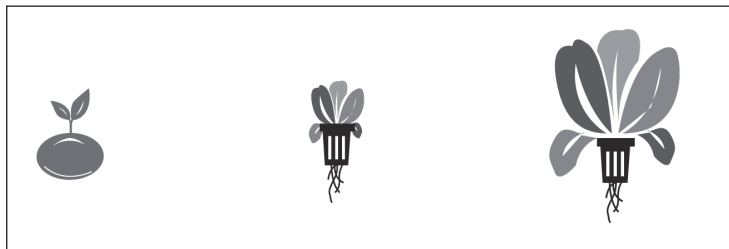

### Step 4: Sprout-Seedling-Grow

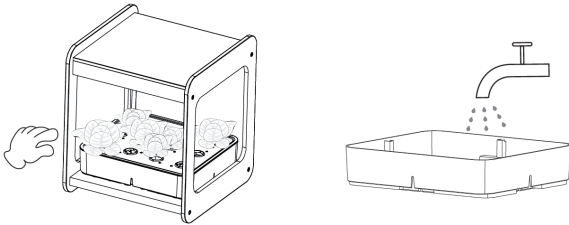

**Step 5: Harvesting and Cleaning**

<b>1</b>	When the plants are ripe, harvest them.
<b>2</b>	When all the plants have been harvested, unite the tank, the filler cap and the plant baskets.
<b>3</b>	If you do not grow any other plants for the time being, disconnect the device from the power supply.
	

**Growth Period**

Germination Stage	3-7 days		Leaf vegetables: 25-40 days
Seedling Stage	7-15 days		Flower: 25-40 days
Growing Period	25-30 days		Fruit/Vegetables: 25-40 days

<b>Influence of ambient temperature on growth</b>		
20-28 °C row normally	≤ 15 °C grow slowly	≥ 35 °C root rot

---

## HINTS ON DISPOSAL

---



According to the European waste regulation 2012/19/EU this symbol on the product or on its packaging indicates that this product may not be treated as household waste. Instead it should be taken to the appropriate collection point for the recycling of electrical and electronic equipment. By ensuring this product is disposed of correctly, you will help prevent potential negative consequences for the environment and human health, which could otherwise be caused by inappropriate waste handling of this product. For more detailed information about recycling of this product, please contact your local council or your household waste disposal service.



**Estimado cliente:**

Le felicitamos por la adquisición de este producto. Lea atentamente el siguiente manual y siga cuidadosamente las instrucciones de uso con el fin de evitar posibles daños. La empresa no se responsabiliza de los daños ocasionados por un uso indebido del producto o por haber desatendido las indicaciones de seguridad. Escanee el código QR para obtener acceso al manual de usuario más reciente y otra información sobre el producto.



---

## ÍNDICE DE CONTENIDOS

---

Indicaciones de seguridad 32  
 Envío 33  
 Montaje 34  
 Plantación y cultivo 38  
 Retirada del aparato 43

---

## DATOS TÉCNICOS

---

Número de artículo	10033199
Fuente de alimentación	220-240 V ~ 50/60 Hz
Capacidad del depósito de agua	7 L

---

## DECLARACIÓN DE CONFORMIDAD

---

**Fabricante:**

Chal-Tec GmbH, Wallstraße 16, 10179 Berlín  
 (Alemania).



**Este producto cumple con las siguientes directivas europeas:**

2014/30/UE (EMC)  
 2014/35/UE (baja tensión)  
 2011/65/UE (refundición RoHS)

---

## INDICACIONES DE SEGURIDAD

---

- Utilice agua de grifo para la plantación. Conecte el aparato a la toma de corriente cuando el depósito de agua esté lleno.
- Cuando la luz está encendida, no la mire directamente para evitar dañar su vista.
- Mantenga la superficie de la lámpara limpia para garantizar una iluminación óptima. Utilice solamente un paño seco para limpiar la bombilla.
- No limpie la lámpara con productos químicos, alcohol o gasolina, ya que podría cambiar de color y averiarse.
- Desenchufe el aparato si no va a utilizarlo durante un periodo prolongado de tiempo.
- No instale el aparato en un entorno inflamable, explosivo o húmedo.
- Coloque el aparato en una superficie nivelada y estable.
- Si el aparato no funciona correctamente, desenchúfelo de inmediato y llévalo a un servicio técnico para su supervisión y reparación.
- Si el cable de alimentación o el enchufe está dañado, deberá ser sustituido por el fabricante, una empresa autorizada o una persona cualificada.
- El aparato contiene piezas que no son accesibles para el usuario.
- Solamente un personal técnico cualificado debe llevar a cabo las reparaciones.

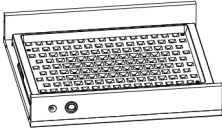
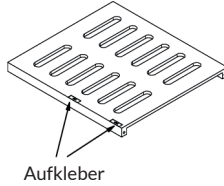
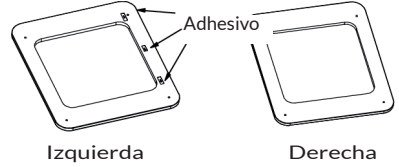
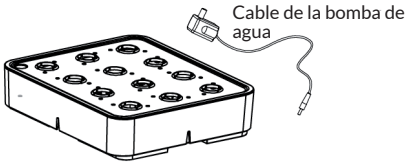
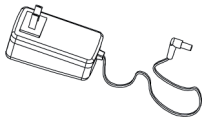
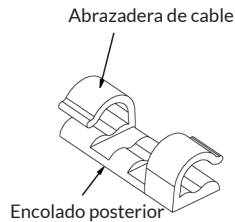

## ENVÍO

**1 Placa superior (x1)****2 Placa de base (x2)****3 Placas laterales (x2)****4 Depósito de agua (incl. tapa y bomba de agua)****5 Maceta (x12)****6 Espuma de plántulas (x12)****7 Cable de alimentación (x1)****8 Piezas pequeñas**

**Abrazaderas de cable (x5)**



**Tornillo hexagonal (x8)**

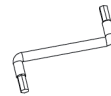

**Llave Allen (x1)**

## MONTAJE

### Paso 1: Montaje del marco de madera

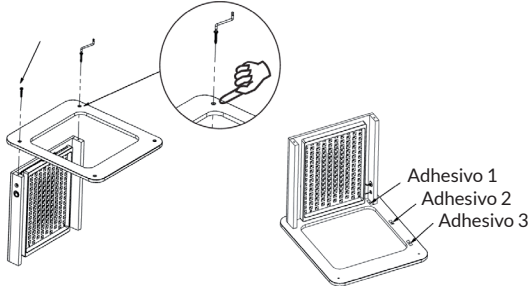
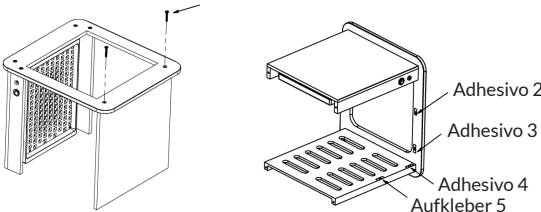
1	<p>Extraiga todas las partes del embalaje y compruebe si faltan algunas piezas y si están dañadas.</p>
2	<p>Coloque la placa superior en una superficie suave. Fije la placa lateral con los 3 adhesivos en la placa superior con la ayuda de los tornillos. Utilice la llave Allen para fijarlos.</p> 
3	<p>Monte una de las placas de base en la placa lateral con la ayuda de tornillos. Asegúrese de que los adhesivos en la placa de base señalen en la misma dirección que los adhesivos de la placa lateral.</p> 

A continuación, fije la segunda placa lateral al marco con la ayuda de los tornillos.

4

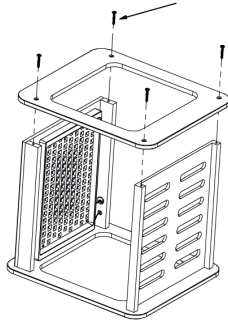

### Paso 2: Fijar abrazaderas de cable y el cable de bomba

Retire el adhesivo 1 y pegue la parte posterior de la abrazadera de cable en el lugar donde se encontraba el adhesivo.

1

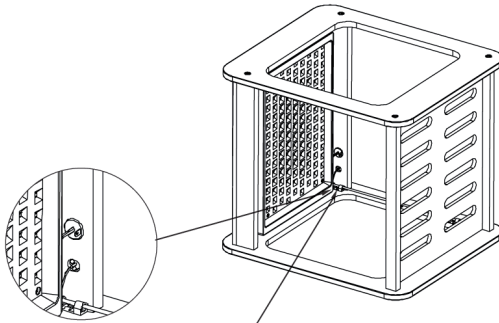

Abrazadera de cable 1

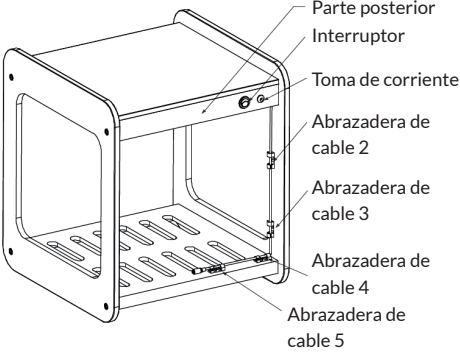
2	Repita este paso retirando el adhesivo 2 y 3 en la placa lateral y pegando las abrazaderas de cable en el lugar donde antes estaba el adhesivo.
3	Repita este paso retirando el adhesivo 4 y 5 en la placa de base y pegando las abrazaderas de cable en el lugar donde antes estaba el adhesivo.
4	<p data-bbox="372 248 893 272">Fije el cable alargador de la bomba de agua en las 5 abrazaderas.</p>  <p data-bbox="804 360 934 379">Parte posterior</p> <p data-bbox="804 387 900 406">Interruptor</p> <p data-bbox="804 432 956 451">Toma de corriente</p> <p data-bbox="804 477 927 496">Abrazadera de cable 2</p> <p data-bbox="804 537 927 557">Abrazadera de cable 3</p> <p data-bbox="804 614 927 633">Abrazadera de cable 4</p> <p data-bbox="804 675 900 694">Abrazadera de cable 5</p>

### Paso 3: Instalación del depósito de agua

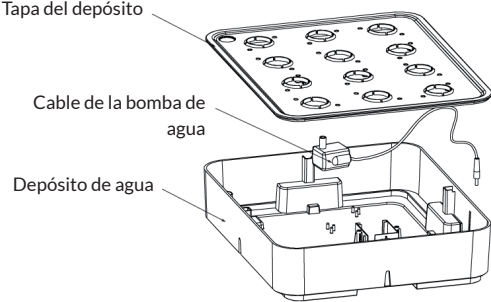
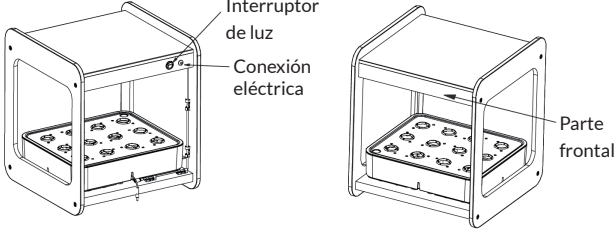
<p><b>1</b></p>	<p>Retire la tapa del depósito de agua y añada agua, así como una solución nutritiva. Puede encontrar información más detallada sobre la concentración de la solución nutritiva en el apartado PLANTACIÓN Y CULTIVO.</p> 
<p><b>2</b></p>	<p>Coloque el depósito de agua (el cable de la bomba de agua y el cable alargador de la bomba de agua están en el mismo lado) sobre la placa de base en el marco y conecte el cable de la bomba de agua al cable alargador.</p>
<p><b>3</b></p>	<p>El interruptor de luz se encuentra en la parte posterior del aparato. Púselo para encender y apagar la luz LED.</p>
<p><b>4</b></p>	<p>Conecte el enchufe para empezar la plantación.</p> 

## Indicaciones sobre el sistema de control inteligente (Smart Control)

	<ul style="list-style-type: none"> <li>• Cuando el interruptor está en (O), la luz de cultivo se enciende durante un largo periodo de tiempo. Cuando el interruptor está en (I), la luz de cultivo está encendida y el temporizador, activado. La luz de cultivo se apaga después de 14 horas y se enciende automáticamente después 10 horas.</li> <li>• La bomba de agua se enciende y se apaga cada 15 minutos. Después de que el aparato se apague automáticamente, la bomba de agua permanece en estado activo y sigue funcionando.</li> </ul>
---	--

## PLANTACIÓN Y CULTIVO

### Recomendaciones acerca del cultivo

- Compre semillas y soluciones nutritivas en su localidad, por ejemplo, en un mercado de cultivo y plantación.
- Las espumas de plántulas, las semillas y las soluciones de nutrientes son productos desechables que no se pueden reutilizar. Reponga los productos necesarios para la plantación a tiempo.
- De ser posible, utilice agua filtrada o depurada.

### Paso 1: Preparación de la solución nutritiva

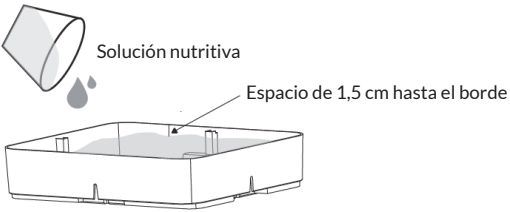
1	Adquiera la concentración nutritiva y dilúyela con agua tal como se indica en el embalaje.
2	<p>Añada agua limpia y fresca al depósito de agua hasta llegar a la marca MAX. Por encima de la marca MAX debe haber un espacio de 1,5 cm hasta el borde.</p> 

Paso 2: Plantación

(A) Plantación con semillas

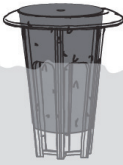
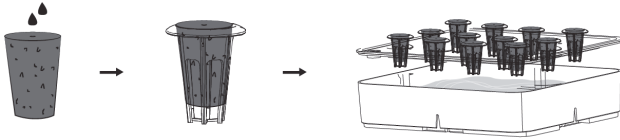
1	Introduzca la espuma de plántulas en las macetas.	 <p data-bbox="692 256 801 384">La parte inferior de la maceta se encuentra en agua.</p>
2	Inserte 2-3 semillas en la espuma de plántulas.	
3	Instale las macetas en los orificios de la tapa del depósito de agua.	
4	Monte el depósito de agua en el marco y asegúrese de que la parte inferior de las macetas toca el agua.	
5	Encienda el aparato y la luz.	
6	Después de 3-7 días, seleccione el brote más fuerte por maceta para su posterior cultivo y deseche las otras plántulas.	
		

(B) Plantación con plántones adquiridos

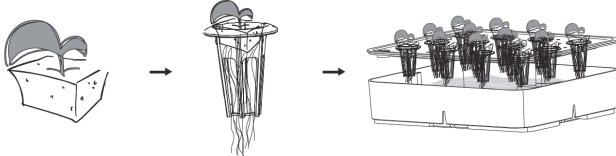
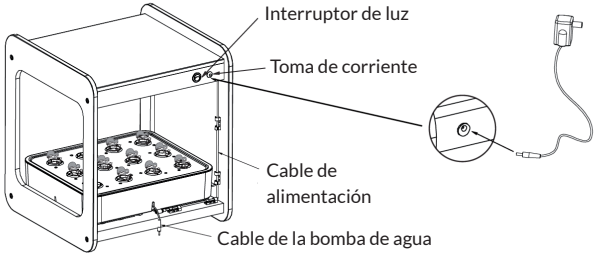
1	Introduzca los plántones en las macetas. Asegúrese de no dañar las raíces de los plántones.
2	Instale las macetas en los orificios de la tapa del depósito de agua.
3	Monte el depósito de agua en el marco y asegúrese de que la parte inferior de las macetas toca el agua.
4	<p>Encienda el aparato y la luz.</p> 
	 <p>Interruptor de luz</p> <p>Toma de corriente</p> <p>Cable de alimentación</p> <p>Cable de la bomba de agua</p>

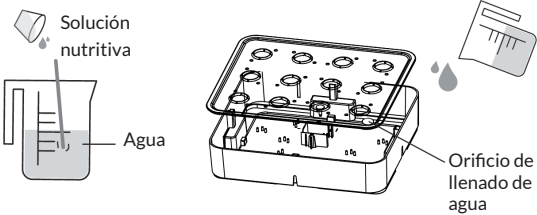

### Paso 3: Cultivo y cuidado

1	Si ve hojas marchitadas, abra la tapa del depósito de agua y compruebe el nivel del agua. Compruebe al menos una vez a la semana el nivel del agua y las raíces.
2	Mezcle regularmente una nueva solución nutritiva en una taza medidora.
3	<p data-bbox="165 277 546 300">Añada la solución nutritiva al depósito de agua.</p> 

**Atención:** el nivel del agua en el depósito no debe ser inferior al de la bomba de agua, de lo contrario, el aparato emite una alarma.

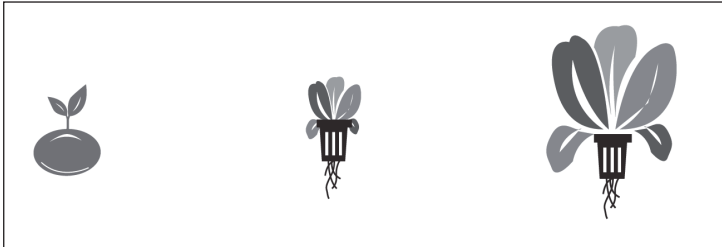

### Paso 4: Fases de crecimiento

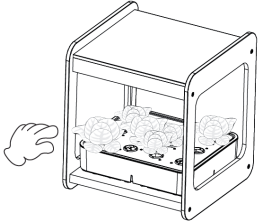
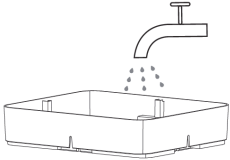

**Paso 5: Cosecha y limpieza**

<b>1</b>	Cuando las plantas hayan madurado, coséchélas.
<b>2</b>	Después de cosechar todas las plantas, limpie el depósito de agua, la tapa del depósito y las macetas.
<b>3</b>	<p>Si no va a cultivar más plantas, desconecte el aparato de la toma de corriente.</p> <div style="display: flex; justify-content: space-around; align-items: center;">   </div>

**Periodo de crecimiento**

Fase de germinación	3-7 días		Fase de crecimiento de verdura de hoja: 25-40 días
Fase de siembra	7-15 días		Fase de crecimiento de flores: 25-40 días
Fase de crecimiento	25-30 días		Fase de crecimiento de verdura/fruta: 25-40 días

<b>Influencia de la temperatura ambiente en el crecimiento</b>		
20-28 °C Crecimiento normal	≤ 15 °C Crecimiento lento	≥ 35 °C Pudrición de la raíz

---

## RETIRADA DEL APARATO

---



Si el aparato lleva adherida la ilustración de la izquierda (el contenedor de basura tachado) entonces rige la normativa europea, directiva 2012/19/UE. Este producto no debe arrojarse a un contenedor de basura común. Infórmese sobre las leyes territoriales que regulan la recogida separada de aparatos eléctricos y electrónicos. Respete las leyes territoriales y no arroje aparatos viejos al cubo de la basura doméstica. Una retirada de aparatos conforme a las leyes contribuye a proteger el medio ambiente y a las personas a su alrededor frente a posibles consecuencias perjudiciales para la salud. El reciclaje ayuda a reducir el consumo de materias primas.



**Chère cliente, cher client,**

Toutes nos félicitations pour l'acquisition de ce nouvel appareil. Veuillez lire attentivement et respecter les instructions de ce mode d'emploi afin d'éviter d'éventuels dommages. Le fabricant ne saurait être tenu pour responsable des dommages dus au non-respect des consignes de sécurité et à la mauvaise utilisation de l'appareil. Scannez le QR-Code pour accéder à la dernière version du mode d'emploi et à d'autres informations concernant le produit.



---

## SOMMAIRE

---

Consignes de sécurité 46  
 Contenu de l'emballage 47  
 Assemblage 48  
 Plantation et culture 52  
 Informations sur le recyclage 57

---

## FICHE TECHNIQUE

---

Numéro d'article	10033199
Alimentation	220-240 V ~ 50/60 Hz
Capacité du réservoir d'eau	7 L

---

## DÉCLARATION DE CONFORMITÉ

---

**Fabricant :**

Chal-Tec GmbH, Wallstraße 16, 10179 Berlin,  
 Allemagne.

**Ce produit est conforme aux directives européennes suivantes :**

2014/30/UE (CEM)  
 2014/35/UE (LVD)  
 2011/65/UE (RoHS)

---

## CONSIGNES DE SÉCURITÉ

---

- Utilisez de l'eau du robinet pour vos plantations. Ne branchez pas l'alimentation tant que le réservoir n'est pas plein.
- Lorsque l'éclairage est allumé, ne regardez jamais directement pour éviter d'endommager vos yeux.
- Gardez la surface des lampes propre pour assurer la meilleure efficacité d'éclairage. Utilisez un chiffon doux pour nettoyer les ampoules.
- Ne nettoyez jamais les lampes avec des agents chimiques, de l'alcool et de l'essence, sinon elles risquent de se décolorer ou d'être endommagées.
- Retirez la fiche de la prise lorsque vous n'utilisez plus l'appareil pour les plantations.
- N'installez pas l'appareil dans un environnement inflammable, explosif ou humide.
- Placez l'appareil sur une surface plane et stable.
- En cas de mauvais fonctionnement de l'appareil, éteignez-le immédiatement l'appareil et consultez un atelier spécialisé pour inspection et réparation.
- Si le cordon d'alimentation ou la fiche est endommagé, il doit être remplacé par le fabricant, un spécialiste agréé ou une personne qualifiée.
- L'appareil contient des pièces inaccessibles à l'utilisateur. Les réparations ne doivent être effectuées que par des spécialistes qualifiés.

## CONTENU DE L'EMBALLAGE

### 1 Plaque supérieure (x1)

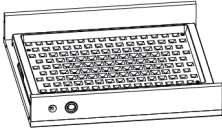

### 2 Plaque de base (x2)

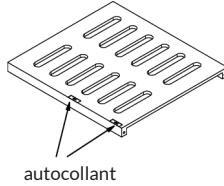

### 3 Plaques latérales (x2)

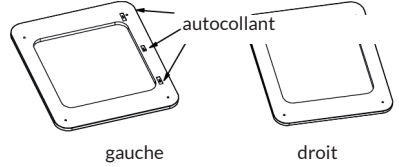

### 4 Réservoir (couvrete et pompe à eau compris)

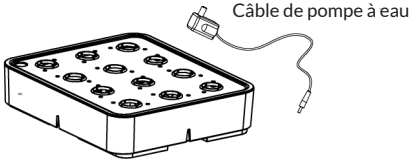

### 5 Paniers de plantes (x12)



### 6 Éponge de plantes (x12)



### 7 Alimentation (x1)

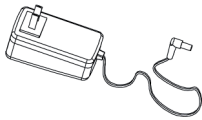

### 8 petites pièces

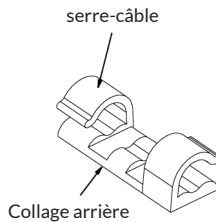

### Serre-câbles (x5)



### Vis à tête hexagonale (x8)

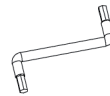

### Clé Allen (x1)

## ASSEMBLAGE

### Étape 1: assemblage du cadre en bois

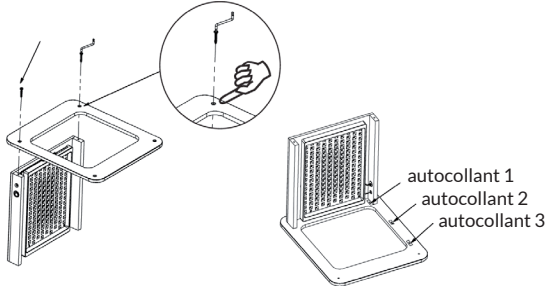
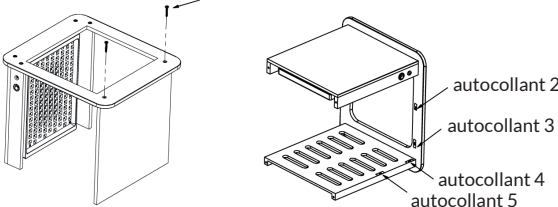
1	Retirez toutes les pièces de l'emballage et vérifiez s'il y a des pièces manquantes ou endommagées.
2	<p data-bbox="370 316 1016 389">Placez la plaque supérieure sur une surface molle. Fixez la plaque latérale avec les 3 autocollants avec des vis sur la plaque supérieure. Utilisez la clé Allen pour serrer.</p> 
3	<p data-bbox="370 746 997 820">Fixez l'une des plaques de base à la plaque latérale avec des vis. Assurez-vous que l'autocollant sur la plaque de base pointe du côté de l'autocollant sur la plaque latérale.</p> 



Fixez ensuite la deuxième plaque latérale au cadre avec des vis.

4

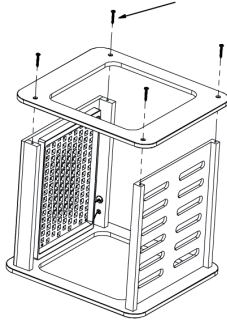

## Étape 2: fixation des serre-câbles et du câble de la pompe

Retirez l'autocollant 1 et collez le dos du serre-câble à l'endroit où l'autocollant se trouvait.

1

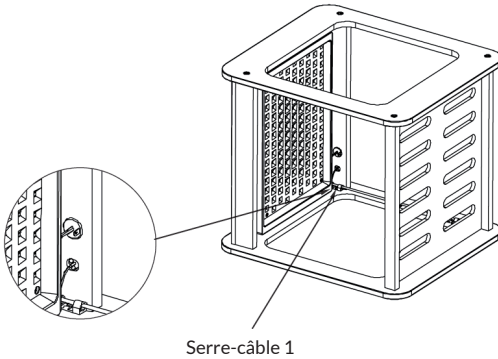

Serre-câble 1

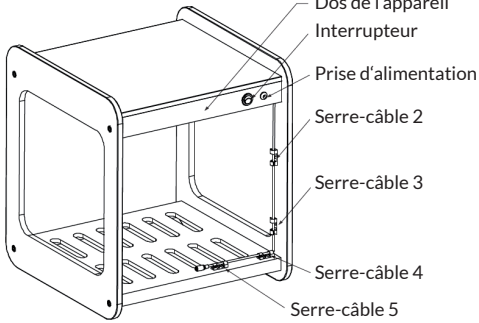
2	Répétez cette procédure en retirant les autocollants 2 et 3 de la plaque latérale et en attachant les serre-câbles aux emplacements des autocollants..
3	Répétez ce processus en retirant les autocollants 4 et 5 sur la plaque de base et en attachant les serre-câbles aux emplacements des autocollants..
4	<p data-bbox="370 248 857 272">Fixez le câble rallonge de la pompe à eau aux 5 serre-câbles.</p>  <p>The diagram shows a perspective view of a rectangular device chassis. On the top surface, there is a power outlet labeled 'Prise d'alimentation' and a switch labeled 'Interrupteur'. On the right side panel, there are two cable clips labeled 'Serre-câble 2' and 'Serre-câble 3'. On the bottom surface, there are two more cable clips labeled 'Serre-câble 4' and 'Serre-câble 5'. The back panel is labeled 'Dos de l'appareil'. A power cord is shown connected to the outlet on the right side.</p>

### Étape 3: Installation du réservoir

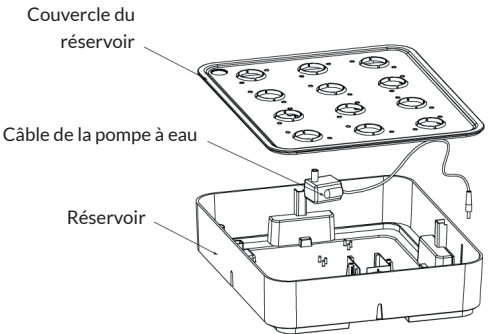
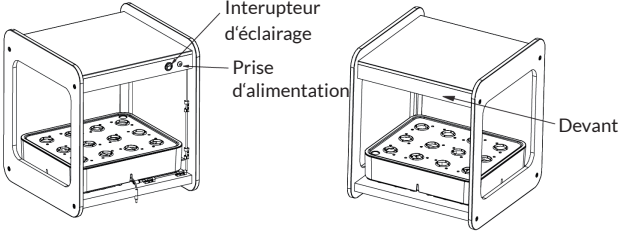
1	<p>Retirez le bouchon du réservoir et ajoutez de l'eau et une solution nutritive dans le réservoir. Vous trouverez des informations détaillées sur la concentration de la solution nutritive dans le chapitre PLANTATION ET CULTURE.</p>  <p>Couvercle du réservoir</p> <p>Câble de la pompe à eau</p> <p>Réservoir</p>
2	<p>Mettez le réservoir (câble de pompe à eau et la rallonge du câble de pompe à eau sont du même côté) sur la plaque de base dans le cadre et connectez le câble de la pompe à eau au câble d'extension.</p>
3	<p>L'interrupteur d'éclairage est situé à l'arrière de l'appareil et permet d'allumer et d'éteindre la lampe LED.</p>
4	<p>Branchez l'alimentation et commencez la plantation.</p>  <p>Interrupteur d'éclairage</p> <p>Prise d'alimentation</p> <p>Devant</p>

### Remarque concernant le système Smart Control

	<ul style="list-style-type: none"> <li>• Lorsque l'interrupteur est sur (O), l'éclairage de l'installation reste éteint pour longtemps. Lorsque l'interrupteur est sur (I), l'éclairage de l'installation est activé et la minuterie démarre. L'éclairage de la plantation s'éteint automatiquement au bout de 14 heures et se rallume automatiquement 10 heures plus tard.</li> <li>• La pompe à eau s'allume puis s'éteint alternativement pendant 15 minutes. Une fois l'éclairage du système éteint automatiquement, la pompe à eau reste allumée et continue à fonctionner.</li> </ul>
---	---

## PLANTATION ET CULTURE

### Conseils pour la plantation

- Veuillez acheter des semences et des solutions nutritives près de chez vous, par exemple dans une grande surface de bricolage ou de jardinage.
- Les éponges végétales, les semences et les solutions nutritives sont des produits jetables qui ne peuvent pas être réutilisés. Veuillez rajouter à temps les produits nécessaires pour la plantation.
- Si possible, utilisez de l'eau filtrée et purifiée

### Étape 1: préparation de la solution nutritive

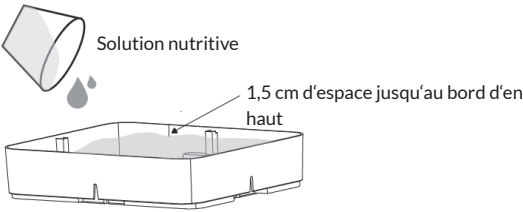
1	Procurez-vous un concentré de nutriments et diluez-le dans l'eau comme indiqué sur l'emballage.
2	<p>Versez de l'eau propre et fraîche jusqu'à la marque MAX dans le réservoir. Il doit y avoir 1,5 cm d'espace au-dessus de la marque MAX jusqu'au bord.</p> 

## Étape 2 : plantation

### (A) Plantation avec des graines

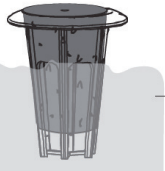
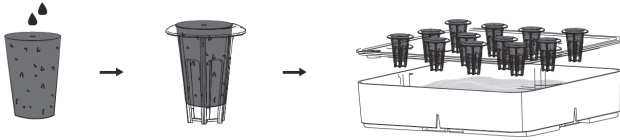
1	Placer l'éponge naturelle dans le panier à plantes.	 <p data-bbox="692 256 792 384">Le fond du panier à plantes se trouve dans l'eau</p>
2	Mettez 2-3 graines dans l'éponge naturelle.	
3	Mettez les paniers à plantes dans les trous du couvercle du réservoir.	
4	Placez le réservoir dans le cadre et assurez-vous que les fonds des paniers touchent l'eau.	
5	Allumez l'appareil et l'éclairage.	
6	Au bout de 3 à 7 jours, sélectionnez la pousse la plus forte de chaque panier de plantation pour continuer à le cultiver et jetez les autres plants.	
		

(B) Plantation avec des plants achetés

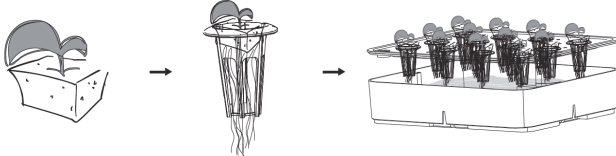
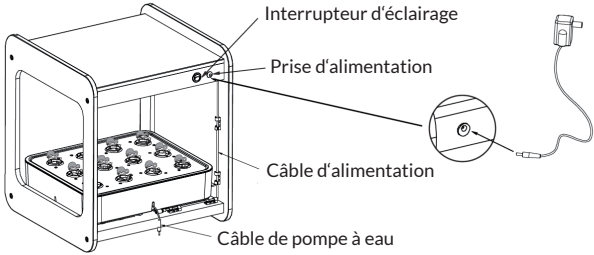
1	Mettez les plants dans les paniers à plantes. Veillez à ne pas endommager les racines des plants.
2	Mettez les paniers dans les trous du couvercle de réservoir.
3	Mettez le réservoir dans le cadre et assurez-vous que les fonds des paniers à plantes touchent l'eau.
4	<p>Allumez l'appareil et l'éclairage.</p> 
	 <p>Interrupteur d'éclairage Prise d'alimentation Câble d'alimentation Câble de pompe à eau</p>

### Étape 3 : culture et soins

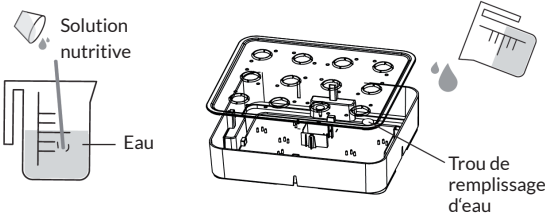
1	Si vous découvrez des feuilles desséchées, ouvrez le bouchon du couvercle et vérifiez le niveau d'eau. Vérifiez le niveau d'eau et les racines au moins une fois par semaine.
2	Ajoutez régulièrement de la solution nutritive dans une tasse à mesurer.
3	<p>Ajouter la solution nutritive dans le réservoir.</p> 

**Remarque :** Le niveau d'eau du réservoir ne doit pas se situer sous la pompe à eau, sinon le produit déclenche une alarme.

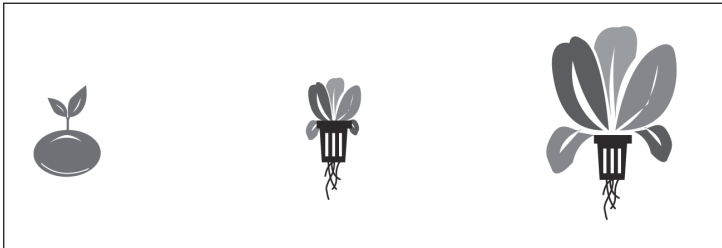

### Étape 4 : du germe à la récolte

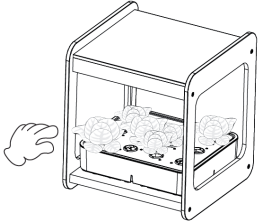
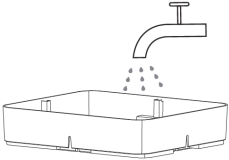

### Étape 5 : récolte et nettoyage

<b>1</b>	Lorsque les plantes sont mûres, récoltez-les.
<b>2</b>	Lorsque toutes les plantes ont été récoltées, nettoyez le réservoir, le couvercle du réservoir et les paniers.
<b>3</b>	Si vous ne cultivez pas d'autres plantes, débranchez l'appareil du secteur.   

### Durée de croissance

Phase de germination	3-7 jours		Durée de croissance des légumes à feuilles : 25-40 jours
Semis	7-15 jours		Durée de croissance des fleurs : 25-40 jours
Période de croissance	25-30 jours		Durée de croissance des fruits / Légumes : 25-40 jours

Influence de la température ambiante sur la culture		
20-28 °C normale	≤ 15 °C Croissance ralentie	≥ 35 °C pourrissement des racines



---

## INFORMATIONS SUR LE RECYCLAGE

---



Le pictogramme ci-contre apposé sur le produit signifie que la directive européenne 2012/19/UE s'applique (poubelle à roues barrée d'une croix). Ces produits ne peuvent être jetés dans les poubelles domestiques courantes. Renseignez-vous concernant les règles appliquées pour la collecte d'appareils électriques et électroniques. Conformez-vous aux réglementations locales et ne jetez pas vos anciens produits avec les ordures ménagères. Le respect des règles de recyclage des vieux produits aide à la protection de l'environnement et de la santé de votre entourage contre les conséquences négatives possibles. Le recyclage des matériaux aide à réduire l'utilisation des matières premières.



**Gentile cliente,**

La ringraziamo per aver acquistato il dispositivo. La preghiamo di leggere attentamente le seguenti istruzioni per l'uso e di seguirle per evitare possibili danni tecnici. Non ci assumiamo alcuna responsabilità per danni scaturiti da una mancata osservazione delle avvertenze di sicurezza e da un uso improprio del dispositivo. Scansionare il codice QR seguente, per accedere al manuale d'uso più attuale e per ricevere informazioni sul prodotto.



---

## INDICE

---

Avvertenze di sicurezza 60  
 Volume di consegna 61  
 Montaggio 62  
 Piantagione e crescita 66  
 Smaltimento 71

---

## DATI TECNICI

---

Numero articolo	10033199
Alimentazione	220-240 V ~ 50/60 Hz
Capacità serbatoio acqua	7 litri

---

## DICHIARAZIONE DI CONFORMITÀ

---

**Produttore:**

Chal-Tec GmbH, Wallstraße 16, 10179 Berlino,  
 Germania.



**Questo prodotto è conforme alle seguenti direttive europee:**

2014/30/UE (EMC)  
 2014/35/UE (LVD)  
 2011/65/UE (RoHS)

---

## AVVERTENZE DI SICUREZZA

---

- Utilizzare acqua del rubinetto per la piantagione. Collegare il dispositivo alla rete elettrica solo quando il serbatoio è pieno.
- Quando la luce è accesa, non guardarla direttamente per evitare danni agli occhi.
- Tenere pulita la superficie delle lampade per garantire un'efficacia ottimale della luce. Utilizzare un panno morbido per pulire le luci.
- Non pulire mai le luci con prodotti chimici, alcool e benzina, in quanto potrebbero subire modifiche nel colore o rovinarsi.
- Staccare la spina dalla presa elettrica se il dispositivo non viene più utilizzato per la piantagione.
- Non posizionare il dispositivo in un ambiente infiammabile, esplosivo o umido.
- Posizionare il dispositivo su una superficie piana e stabile.
- Se il dispositivo presenta malfunzionamenti, spegnere immediatamente l'alimentazione e rivolgersi a un'azienda tecnica per controllo e riparazione.
- Se il cavo o la spina sono danneggiati, devono essere sostituiti dal produttore, da un'azienda tecnica autorizzata o da una persona con qualifica equivalente.
- Il dispositivo contiene componenti che non sono accessibili all'utente. Eventuali riparazioni devono essere realizzate solo da personale tecnico qualificato.

## VOLUME DI CONSEGNA

### 1 Pannello superiore (x1)

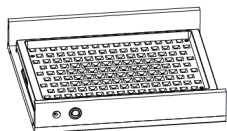

### 2 Pannello base (x2)

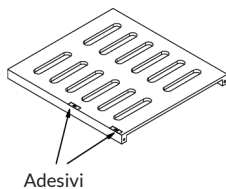

### 3 Pannelli laterali (x2)

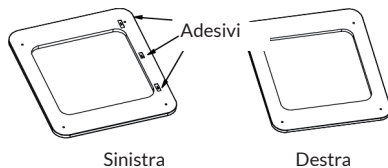

### 4 Serbatoio (incluso coperchio e pompa dell'acqua)

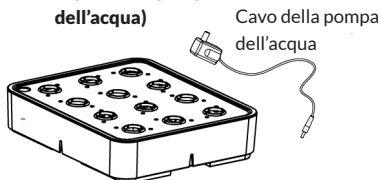

### 5 Cestelli per piante (x12)



### 6 Spugna per piante (x12)



### 7 Trasformatore (x1)

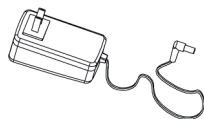

### 8 Piccoli componenti

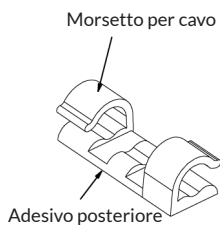

### Morsetti per cavi (x5)



### Viti a brugola (x8)

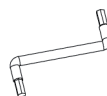

### Chiave a brugola (x1)

## MONTAGGIO

### 1° passaggio: montaggio del telaio in legno

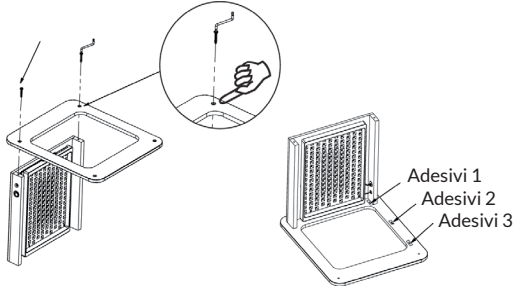
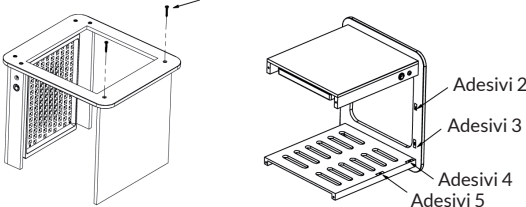
1	Togliere tutti i componenti dall'imballaggio e controllare se delle parti mancano o sono danneggiate.
2	<p>Poggiare il pannello superiore su un fondo morbido. Fissare il pannello laterale con i 3 adesivi al pannello superiore con le viti. Utilizzare la chiave a brugola per stringerle.</p> 
3	<p>Fissare uno dei pannelli base al pannello laterale con le viti. Assicurarsi che l'adesivo del pannello base sia rivolto sullo stesso lato in cui sono rivolti gli adesivi del pannello laterale.</p> 

Fissare il secondo pannello laterale al telaio con le viti.

4

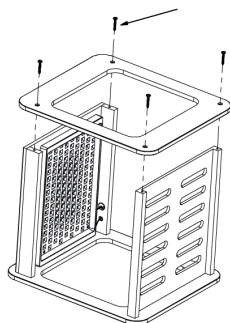

## 2° passaggio: fissaggio dei morsetti per cavi e del cavo della pompa

Togliere adesivo 1 e incollare il retro del morsetto per cavo al punto in cui si trovava l'adesivo.

1

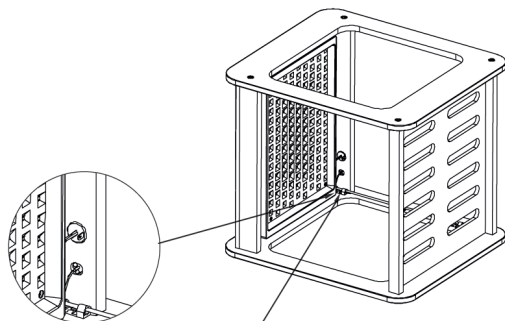

Morsetto per  
cavo 1

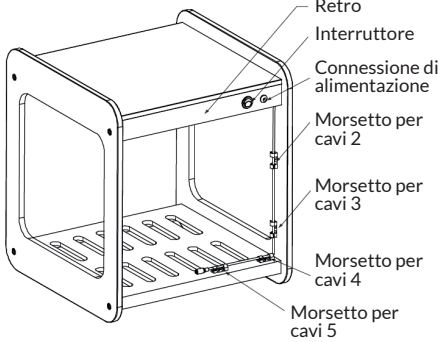
2	Ripetere questo passaggio togliendo adesivi 2 e 3 dal pannello laterale e fissando i morsetti per cavi al posto degli adesivi.
3	Ripetere questo passaggio togliendo adesivi 4 e 5 dal pannello laterale e fissando i morsetti per cavi al posto degli adesivi.
4	<p data-bbox="370 248 896 272">Fissare la prolunga della pompa dell'acqua ai 5 morsetti per cavi.</p>  <p data-bbox="804 360 934 703">Retro Interruttore Connessione di alimentazione Morsetto per cavi 2 Morsetto per cavi 3 Morsetto per cavi 4 Morsetto per cavi 5</p>

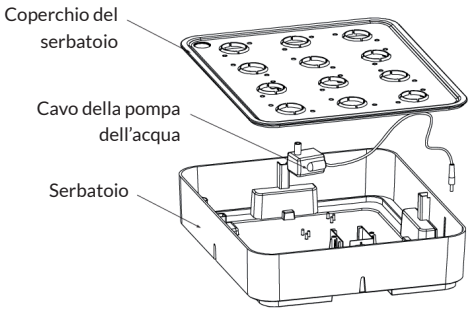
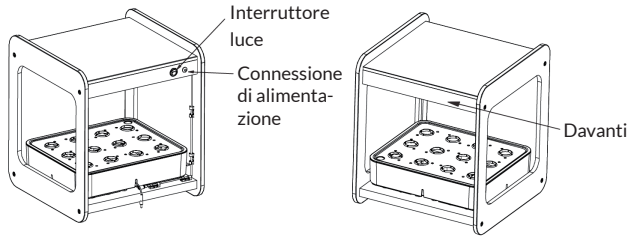

### 3° passaggio: installazione del serbatoio

<p><b>1</b></p>	<p>Togliere il coperchio del serbatoio e aggiungere acqua e una soluzione di sostanze nutritive. Informazioni dettagliate sulla concentrazione della soluzione nutritiva si trovano nel capitolo PIANTAGIONE E CRESCITA</p> 
<p><b>2</b></p>	<p>Mettere il serbatoio (prolunga e cavo della pompa dell'acqua sono sullo stesso lato) sul pannello base nel telaio e collegare il cavo della pompa dell'acqua con la prolunga.</p>
<p><b>3</b></p>	<p>L'interruttore della luce si trova sul retro del dispositivo e serve ad accendere e spegnere la luce LED.</p>
<p><b>4</b></p>	<p>Collegare il trasformatore e iniziare a piantare.</p> 

## Avvertenza su Smart-Control-System

	<ul style="list-style-type: none"> <li>• Quando l'interruttore viene posizionato su (0), la luce si spegne per tempo più lungo. Quando l'interruttore viene posizionato su (I), la luce è accesa e viene attivato il timer. La luce si spegne automaticamente dopo 14 ore e si riaccende di nuovo dopo 10 ore.</li> <li>• La pompa dell'acqua viene spenta e accesa alternativamente per 15 minuti. Dopo lo spegnimento automatico dell'illuminazione, la pompa resta accesa e continua a funzionare.</li> </ul>
---	--

## PIANTAGIONE E CRESCITA

### Consigli per piantare

- Acquistare semi e soluzioni nutritive presso centri di giardinaggio o rivenditori specializzati della vostra zona.
- Spugne per piante, semi e soluzioni nutritive sono prodotti monouso e non possono essere riutilizzati. Rifornirsi per tempo dei prodotti necessari alla piantagione.
- Se possibile, utilizzare acqua filtrata e depurata.

### 1° passaggio: preparare la soluzione nutritiva

1	Acquistare un concentrato di sostanze nutritive e diluirlo con acqua secondo le indicazioni sulla confezione.
2	<p>Riempire il serbatoio di acqua pulita fino al segno MAX. Sopra al segno MAX devono restare 1,5 cm di spazio fino al bordo.</p> 

## 2° passaggio: piantare

### (A) Piantare con semi

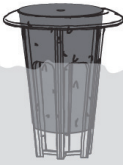
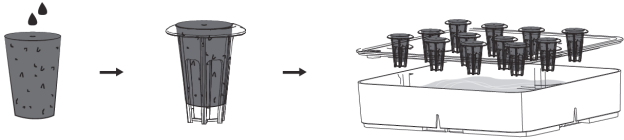
1	Mettere le spugne per le piante nei cestelli.	 <p data-bbox="692 252 785 357">Il fondo del cestello si trova nell'acqua.</p>
2	Mettere 2-3 semi nelle spugne.	
3	Mettere i cestelli nei fori del coperchio del serbatoio.	
4	Mettere il serbatoio nel telaio e assicurarsi che i fondi dei cestelli siano a contatto con l'acqua.	
5	Accendere il dispositivo e l'illuminazione.	
6	Selezionare i germogli più forti per ogni cestello dopo 3-7 giorni per proseguire la crescita e smaltire gli altri germogli.	
		

## (B) Piantare con piantoni acquistati

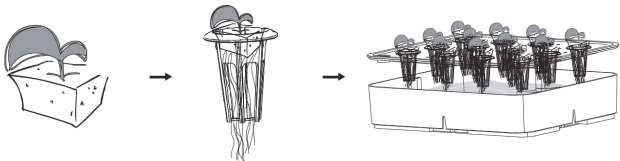
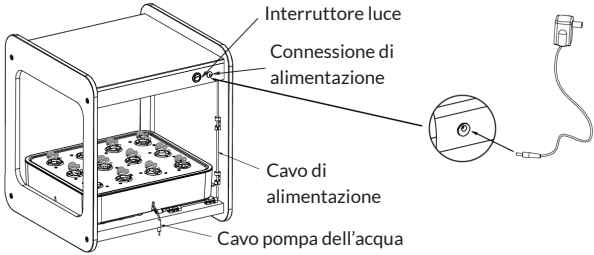
1	Mettere i piantoni nei cestelli. Assicurarsi di non danneggiare le radici dei piantoni.
2	Mettere i cestelli nei fori del coperchio del serbatoio.
3	Mettere il serbatoio nel telaio e assicurarsi che i fondi dei cestelli siano a contatto con l'acqua.
4	<p>Accendere il dispositivo e l'illuminazione.</p> 
	 <p>Interruttore luce Connessione di alimentazione Cavo di alimentazione Cavo pompa dell'acqua</p>

### 3° passaggio: crescita e cura

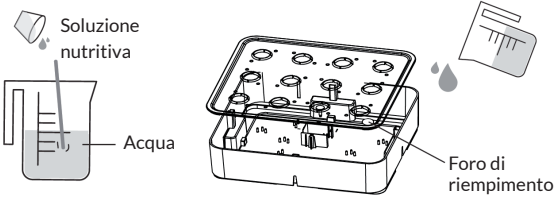
1	Se si trovano foglie appassite, aprire il coperchio del serbatoio e controllare il livello dell'acqua. Controllare radici e livello dell'acqua almeno una volta alla settimana.
2	Mescolare regolarmente nuova soluzione nutritiva in un misurino.
3	<p data-bbox="161 304 445 328">Mettere la soluzione nel serbatoio.</p> 

**Avvertenza:** il livello dell'acqua del serbatoio non deve trovarsi sotto alla pompa dell'acqua, altrimenti il prodotto emette un allarme.

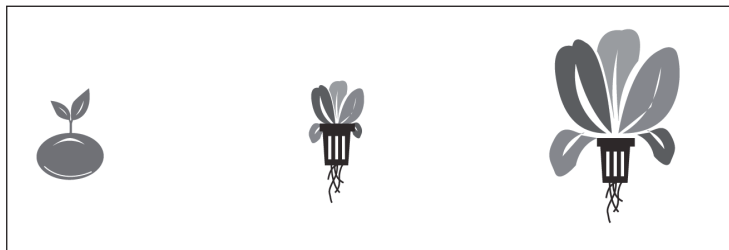

### 4° passaggio: dai germogli al raccolto

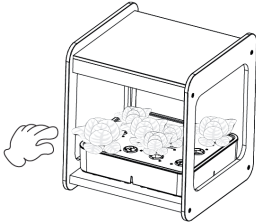
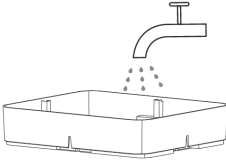

## 5° passaggio: raccolto e pulizia

<b>1</b>	Procedere al raccolto delle piante, non appena sono mature.
<b>2</b>	Una volta raccolte tutte le piante, pulire il serbatoio, il coperchio del serbatoio e i cestelli per le piante.
<b>3</b>	<p>Se per il momento non vengono piantate altre piante, scollegare il dispositivo dall'alimentazione elettrica.</p> <div style="display: flex; justify-content: space-around; align-items: center;">   </div>

### Durata della crescita

Fase di germinazione	3-7 giorni		Durata della crescita di verdure a foglia: 25-40 giorni
Stadio plantula	7-15 giorni		Durata della crescita di fiori: 25-40 giorni
Periodo di crescita	25-30 giorni		Durata della crescita di frutti/ verdure: 25-40 giorni

### Influsso della temperatura ambiente sulla coltivazione

20-28 °C Crescita normale	≤ 15 °C Crescita rallentata	≥ 35 °C Radici marce
------------------------------	--------------------------------	-------------------------

---

## SMALTIMENTO

---



Se sul prodotto è presente la figura a sinistra (il cassonetto dei rifiuti mobile sbarrato), si applica la direttiva europea 2012/19/UE. Questi prodotti non possono essere smaltiti con i rifiuti normali. Informarsi sulle disposizioni vigenti in merito alla raccolta separata di dispositivi elettrici ed elettronici. Non smaltire i vecchi dispositivi con i rifiuti domestici. Grazie al corretto smaltimento dei vecchi dispositivi, si proteggono il pianeta e la salute delle persone da possibili conseguenze negative. Il riciclo di materiali aiuta a ridurre il consumo di materie prime.











