

# DANCOVER<sup>®</sup>

.com



Manual  
for  
Polytunnel Greenhouse  
2,2x3x1,9m

22-03-2018

# DANCOVER<sup>®</sup>

.com

## Safety Advice

### Attention

In some countries approval is needed to set up a marquee/tent larger than 75 m<sup>2</sup>. It is your responsibility to comply with local rules and regulations and to ensure that the marquee/tent is assembled correctly.

In case of bad weather conditions, it is your responsibility to ensure the marquee/tent is safely secured and that the marquee/tent does not cause damage to others.

Do not use open fire, welding equipment or other sources which can ignite, inside or close to the tent.

The marquee/tent must be safely secured. We recommend you secure your marquee/tent with straps and pegs as soon as it is assembled.

Make sure to check if the marquee/tent is covered by your home contents insurance.

Marquees/tents must be evacuated under extreme weather conditions.

In the event of snow always remove snow from the roof of the marquee/tent regularly to prevent snow from building on the roof as heavy snow can cause the marquee/tent to collapse.

In the event of rain there is a risk of rain puddles building up on top of the roof of the marquee/tent. Heavy rain puddles can cause the roof to collapse. It is your responsibility to ensure rain puddles do not build up. As a precaution, make sure the roof of the marquee/tent is stretched out properly and adequately over the side frames of the marquee/tent and remove rain water regularly.

Do not unpack or repack your marquee/tent in freezing temperatures. In case of temperatures below zero always unpack and repack your marquee/tent indoors to avoid the risk of cracking parts.

The marquee/tent must be totally dry before you repack and store it to avoid mildew.

Note: Marquees are intended for events and other arrangements and are as such only meant for short term temporary assembly and the following disassembly. Dancover warranty applies only to the normal use of the Product, normal wear and tear excepted, in accordance with written use instructions or manual. The warranty does not apply to damage caused by accident, abuse, misuse, or modification of the Product.

### Warranty Information

Please visit [dancovershop.com](http://dancovershop.com) for information on warranty.

*Please always check our website for the latest safety advice and manual.*

# Assembly instructions



Min. 10°C



∅ 2 mm



## 1. The tunnel's frame

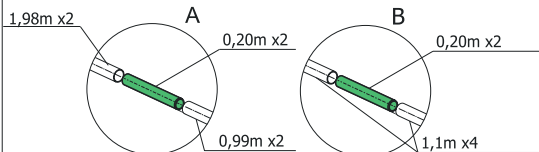
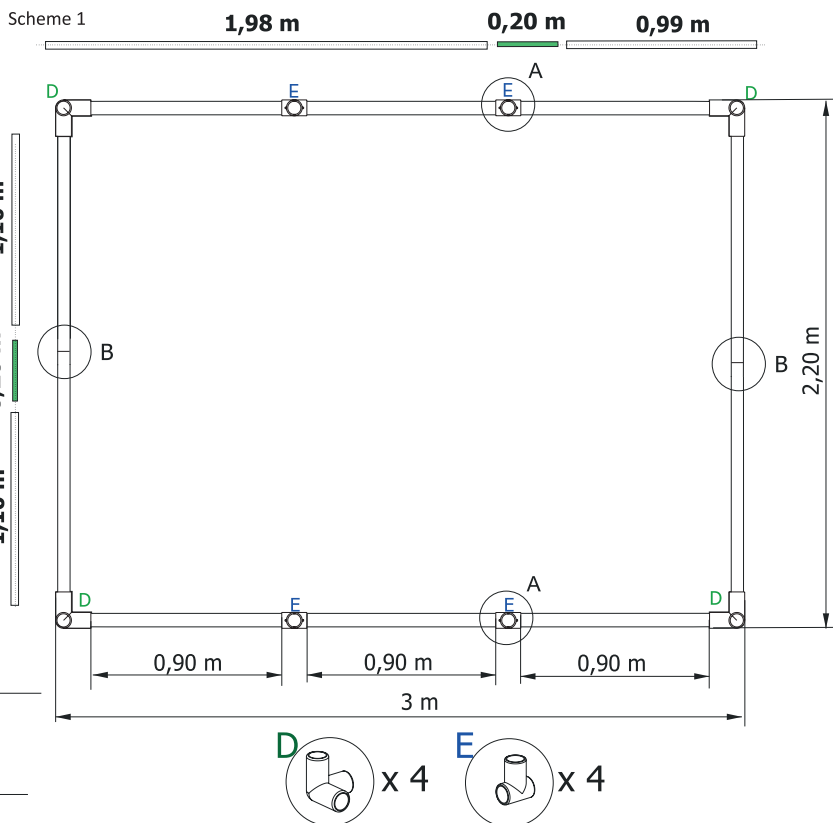

## 2. The tunnel's bows

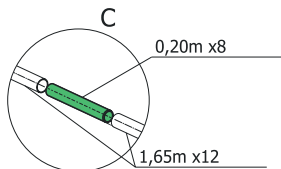
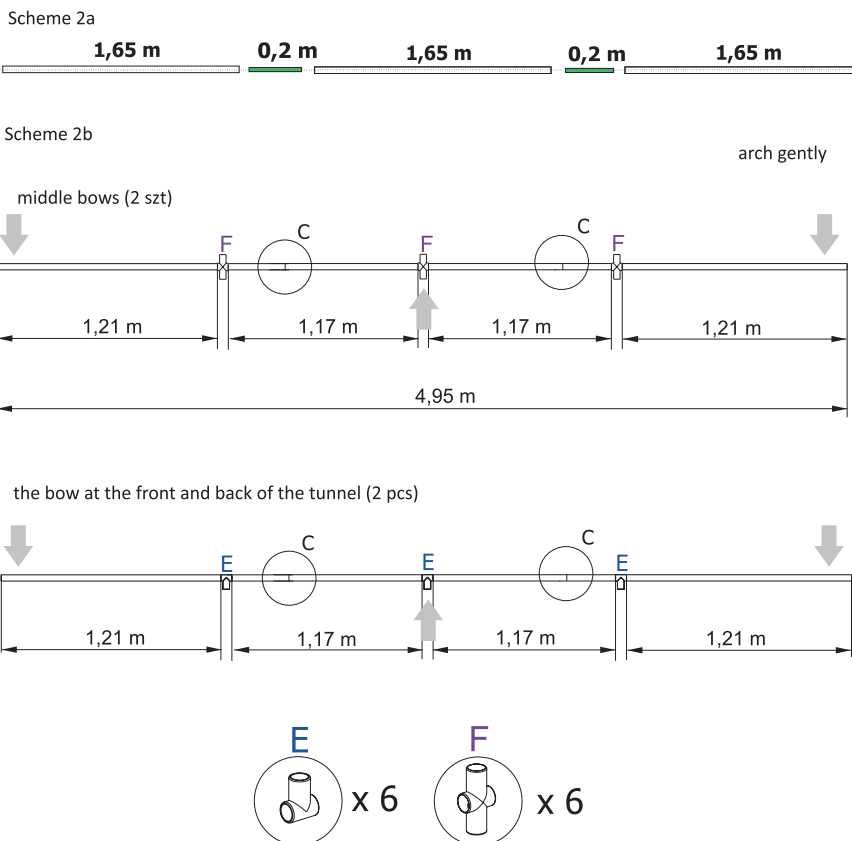

# Assembly instructions



Min. 10°C



Ø 2 mm



## 3. The front and back of the tunnel

Scheme 3

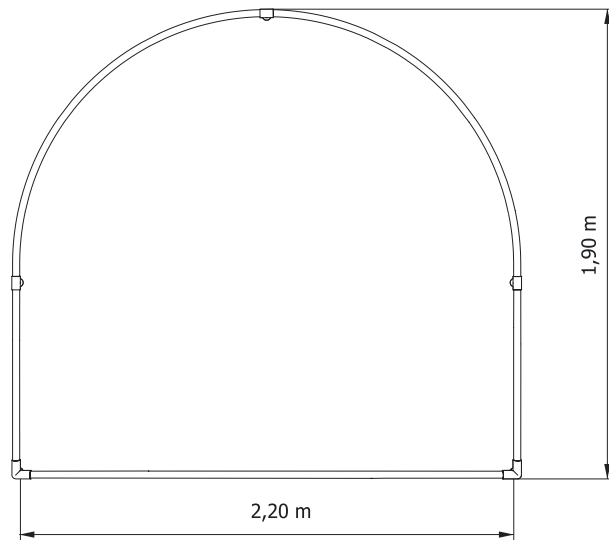

## 4. Assembly of the foil

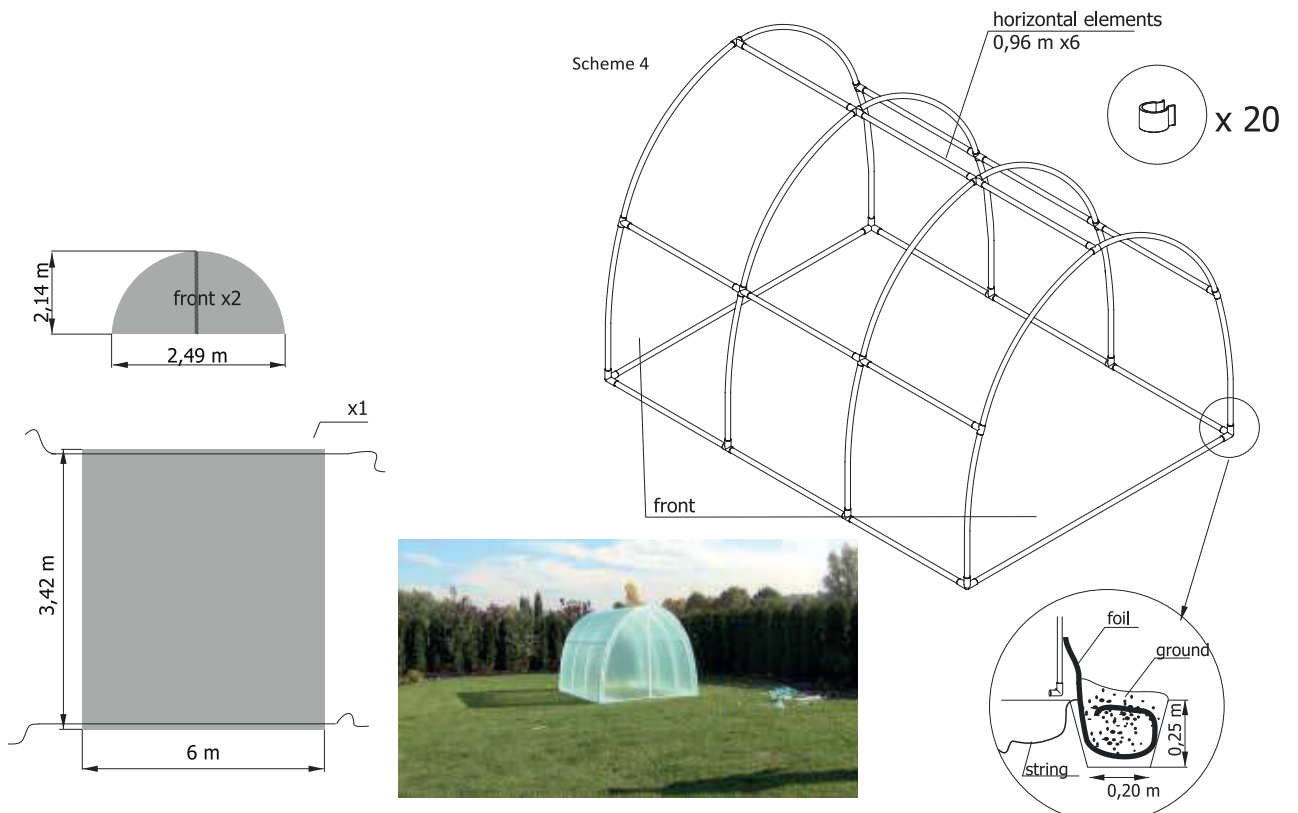

Scheme 4







## THE COMPONENTS OF TUNNEL CONSTRUCTION

	1,98 m	the tunnel's length	T00064	2 pcs
	1,65 m	bows	T00062	12 pcs
	1,10 m	the tunnel's width	T00058	4 pcs
	0,99 m	the tunnel's length	T00057	2 pcs
	0,96 m	horizontal elements	T00056	9 pcs

\* length tolerance of the tubes is within  $\pm 1$  cm

	Corner T-piece	T00001	4 pcs
	Tunnel T-piece 32/32/90	T00005	10 pcs

	Four-way tunnel piece	T00004	6 pcs
	The pin to foil	T00008	20 pcs
	Connecting tube $\varnothing 28 \times 0,2$ m	T00033	12 pcs
	Tacks		1 op
	Assembly pins		8 pcs

## USER'S IMPORTANT INFORMATION

Proper use of the garden tunnel is provided by correct assembly as per the manufacturer's instructions:

1. The tunnel must be carefully assembled, as per the guidelines in the manual.
2. All elements of the tunnel construction should be carefully secured with tacks in the connections from all sides where the tube joins the fitting.
3. The foil should be assembled on sunny and windless days, which will make the work considerably easier. Firm tightening and stable mounting of the foil is very important, which mainly influences the durability of the material.
4. **During winter periods garden foil should be removed from the construction.**
5. In order to secure the tunnel against difficult weather conditions, the users themselves should additionally strengthen the tunnel by sticking metal or wooden poles and fasten them to the bows.
6. In longer tunnels additional reinforcement of the whole construction is recommended, through connection of particular bows in their upper part with the use of an additional tube or a thick wire (the so-called ridge lath)
7. The tunnel's construction may additionally be reinforced using polypropylenic string that will be winding crossly the tunnel's surface and that will be fastened to the metal hooks at the ground.
8. Don't leave the tunnel opened at strong wind, because it may cause the damage of particular parts of the tunnel.
9. One should not attach the strings supporting the plants to the bows, because it may cause the damage of particular parts of the tunnel.
10. The garden tunnel should not be placed in the open space. It should be placed near the buildings or trees and bushes.
11. During the assembly the ambient temperature should not be lower than 10°C.

**THE MANUFACTURER is not responsible for improper use of the tunnel, other than intended use and for the damages that occurred as a result of extreme weather conditions, such as strong wind, hailstorm, snow etc.**

 Three-layered foil

Internal layer ensures increased thermal insulation properties, which results in keeping greater amount of thermal radiation inside the tunnel.

External layers ensure:

proper elasticity, increased durability and resistance to damages and perfect permeability of light.

**Advantages of three-layered foil**

- perfect mechanic durability (addition of metallocene)
- perfect permeability of daylight
- high elasticity and resistance to low temperatures
- ensuring the greenhouse effect

## How to use the tacks to secure the tunnel construction

Drill the holes with a 2 mm diameter drill and insert the attached nails on each joint of the pipe with the fitting on both sides.





## Contact information

### Head office:

Dancover A/S  
Nordre Strandvej 119 G  
3150 Hellebæk  
Denmark

For more information  
please visit:  
[www.dancovershop.com](http://www.dancovershop.com)

## National contact

Denmark: 70 26 76 20  
[denmark@dancover.com](mailto:denmark@dancover.com)

UK: 020 8099 7570  
[uk@dancover.com](mailto:uk@dancover.com)

Germany: 041 0266 7040  
[germany@dancover.com](mailto:germany@dancover.com)

France: 0975 181 800  
[france@dancover.com](mailto:france@dancover.com)

Sweden: 040 233 262  
[sverige@dancover.com](mailto:sverige@dancover.com)

Finland: 0 931 581 720  
[suomi@dancover.com](mailto:suomi@dancover.com)

Poland: 22 300 8602  
[polska@dancover.com](mailto:polska@dancover.com)

Luxembourg: +49 041 0266 7040  
[luxembourg@dancover.com](mailto:luxembourg@dancover.com)

Portugal: 308 800 899  
[portugal@dancover.com](mailto:portugal@dancover.com)

Spain: 911 436 828  
[espana@dancover.com](mailto:espana@dancover.com)

Italy: 02 479 21 198  
[italia@dancover.com](mailto:italia@dancover.com)

Switzerland: 0840 000125  
[schweiz@dancover.com](mailto:schweiz@dancover.com)

Austria: 0662 626935  
[austria@dancover.com](mailto:austria@dancover.com)

Norway: 231 00 690  
[norge@dancover.com](mailto:norge@dancover.com)

Nederland: 0 858 880 524  
[nederland@dancover.com](mailto:nederland@dancover.com)

Ireland: 0 151 33 003  
[ireland@dancover.com](mailto:ireland@dancover.com)

Belgium: 0 28 08 08 09  
[belgique@dancover.com](mailto:belgique@dancover.com)