

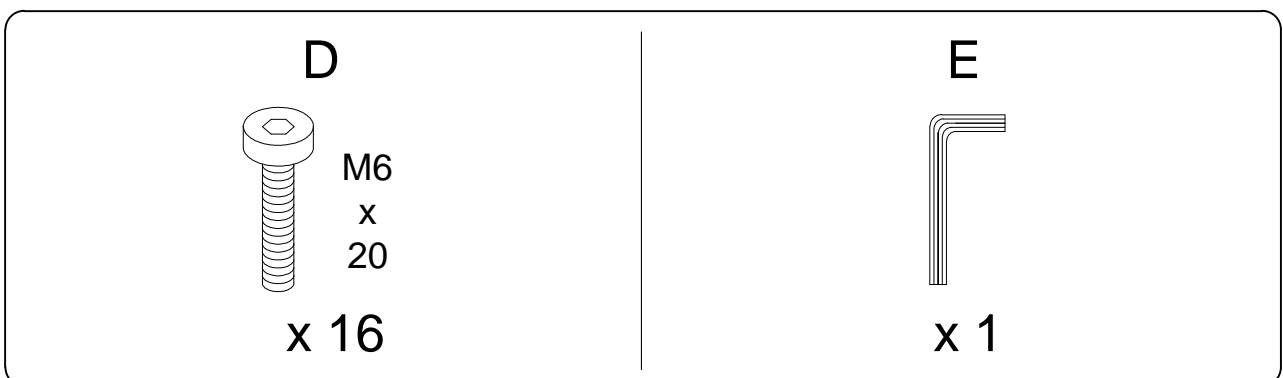

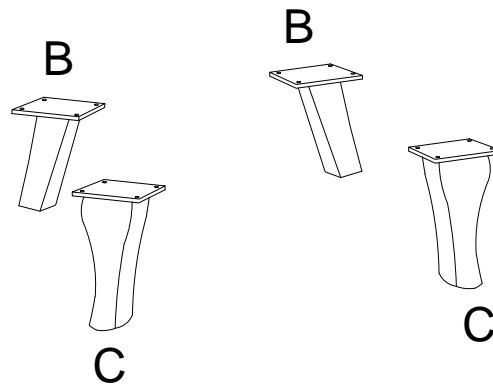
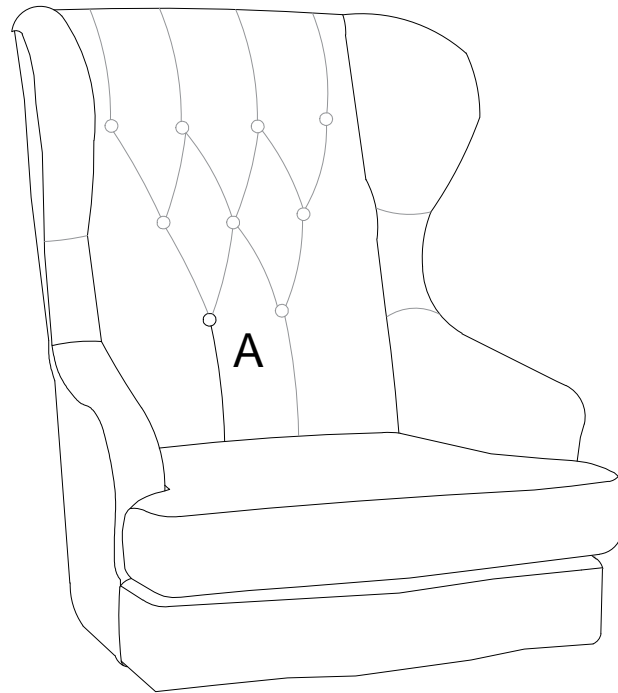
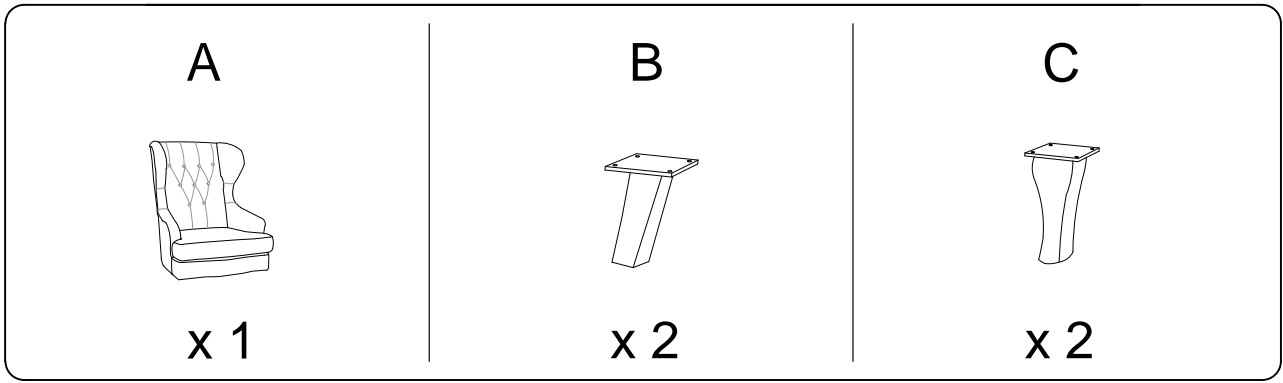

Assembly instructions for the chair, including warnings and requirements.

Warning 1: Do not use power tools (drill) or L-shaped brackets. Estimated time: 10 minutes.

Warning 2: Do not place the chair on a soft surface (carpet). Requires 1 person for assembly.

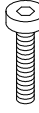
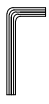

1

A	B	C	D	E
			 M6 x 20	
x 1	x 2	x 2	x 16	x 1

