



blumfeldt



Tahiti

Hollywoodschaukel
Swing Chair

100290200 10033575

Sehr geehrter Kunde,

wir gratulieren Ihnen zum Erwerb Ihres Gerätes. Lesen Sie die folgenden Hinweise sorgfältig durch und befolgen Sie diese, um möglichen Schäden vorzubeugen. Für Schäden, die durch Missachtung der Hinweise und unsachgemäßen Gebrauch entstehen, übernehmen wir keine Haftung. Scannen Sie den folgenden QR-Code, um Zugriff auf die aktuellste Bedienungsanleitung und weitere Informationen rund um das Produkt zu erhalten:

**Dear Customer,**

Congratulations on purchasing this equipment. Please read this manual carefully and take care of the following hints to avoid damages. Any failure caused by ignoring the items and cautions mentioned in the instruction manual is not covered by our warranty and any liability. Scan the QR code to get access to the latest user manual and other information about the product:



WICHTIGE HINWEISE / IMPORTANT NOTES

<p>Sicherheit</p> <ul style="list-style-type: none"> • Stecken Sie beim Ausklappen und Zusammenfallen die Hände nicht in bewegliche Teile der Schaukel. • Überprüfen Sie nach dem Aufstellen der Schaukel, ob sie stabil steht. 	<p>Safety</p> <ul style="list-style-type: none"> • When unfolding and folding, do not put your hands in moving parts of the swing chair. • After setting up the swing chair, check that it is stable.
<p>Reinigung und Pflege</p> <ul style="list-style-type: none"> • Wischen Sie die Schaukel mit einem feuchten Lappen. • Verwenden Sie keine Scheuermittel und scharfen Reiniger. 	<p>Cleaning and Care</p> <ul style="list-style-type: none"> • Wipe the swing chair with a damp cloth. • Do not use scouring agents or sharp cleaners.

EINZELTEILE / PARTS











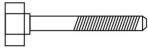
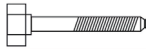
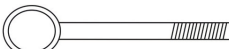

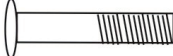
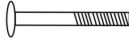
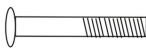



	Bild Picture	Beschreibung Description		Stk. Pcs.
A		Schraube Bolt	M10 x 190 mm	4
B		Schraube Bolt	M10 x 100 mm	4
C		Schraube Bolt	M10 x 100 mm	4
D		Schraubhaken Eye bolt	M10 x 110 mm	2
E		Schraubhaken Eye bolt	M10 x 60 mm	4
F		Bolzenkappe Bolt cap		12
G		Gewindebolzen Thread bolt	M8 x 60 mm	8
H		Gewindebolzen Thread bolt	M6 x 40 mm	12
I		Gewindebolzen Thread bolt	M8 x 80 mm	4
J		Kette (lang) Chain (long)		2
K		Kette (kurz) Chain (short)		2
L		Mutter Nut		14

	Bild Picture	Beschreibung Description	Stk. Pcs.
M		Unterlegscheibe Washer	28
O		Karabiner Hook	6
P		Fuß Leg	4
Q		Bogentraverse Arch connect	1
R		Strebe oben Arch post	2
S		Strebe unten Straight post	2
T		Sitzfläche Seat	1
U		Dach-Streben, quer Roof posts	6
V		Dach-Streben, längs Roof posts	2
W		Armlehnen Arm rests	2
X		Inbusschlüssel Allen wrenches	3
Y		Schlüssel, Griff Wrench, handle	2

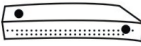
ZUSAMMENBAU / ASSEMBLY

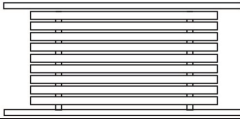
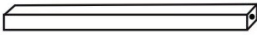



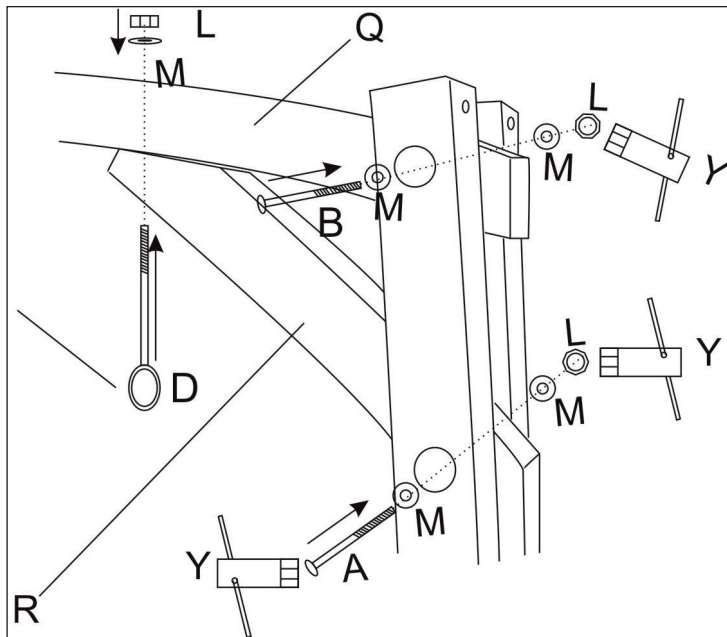
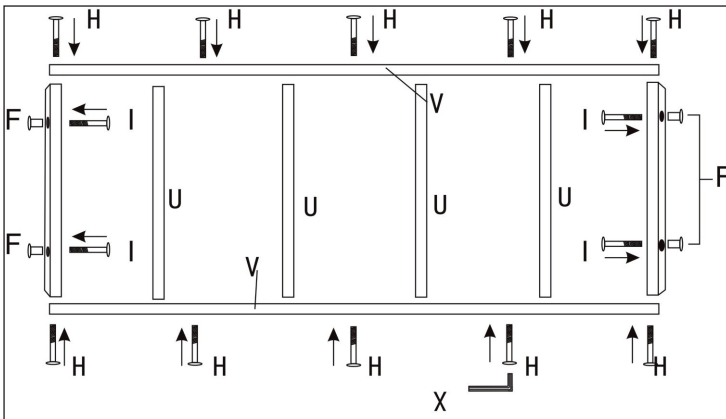
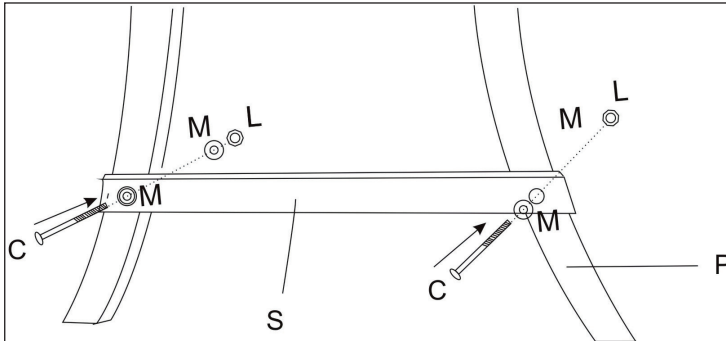
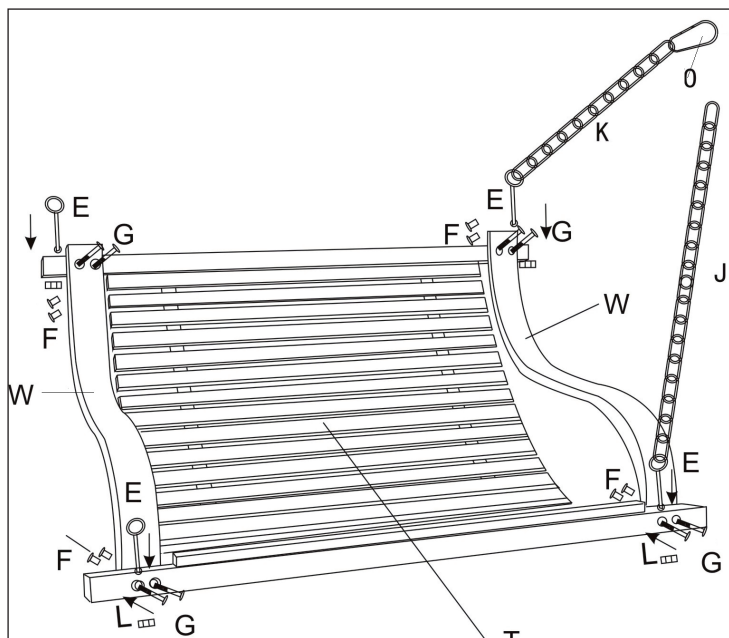

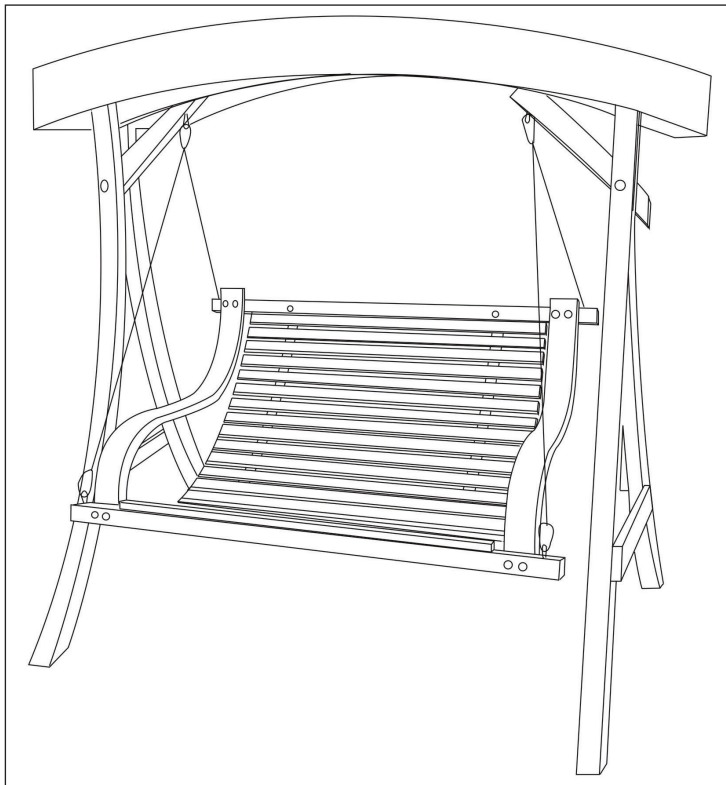

HERSTELLER / PRODUCER

Chal-Tec GmbH, Wallstraße 16, 10179 Berlin, Deutschland (Germany)

