

Milano

Radiator Cabinet

Installation Guide

Contents

Safety Information **Page - 2**

Installation **Page - 2**

Guarantee Information **Page - 6**

Recycling & Disposal **Page - 6**

Safety Information

Please read carefully...

- ✓ Check the product for defects before installing.
- ✓ Ensure all parts are present before you begin installation.

Installation

Tools required for installing:

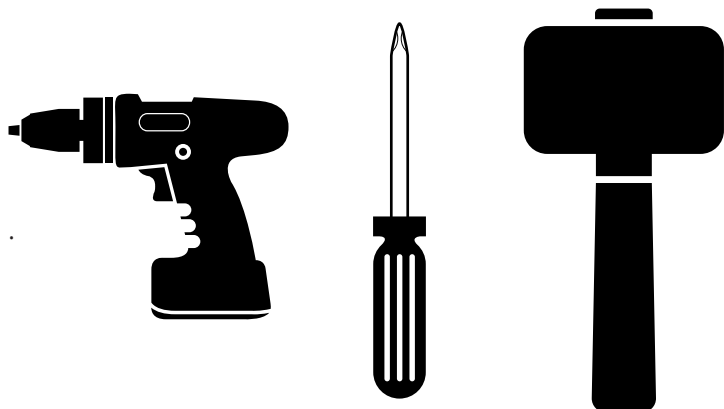

Parts Included:

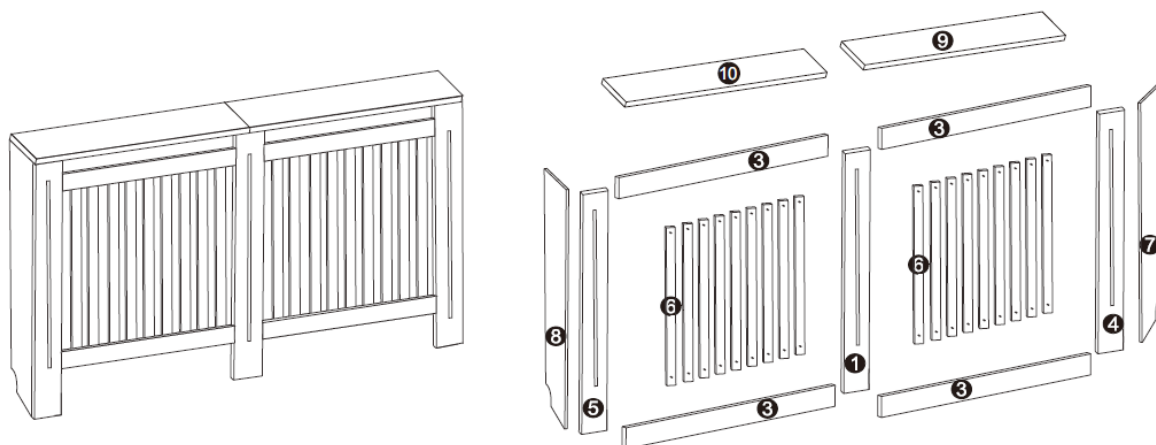

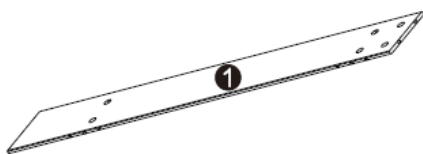

① x1 12x110x803mm

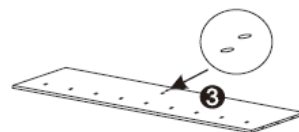

③ x4 12x105x581mm

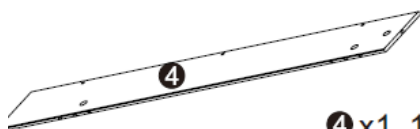

④ x1 12x110x803mm



⑤ x1 12x110x803mm

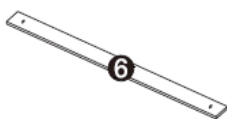

⑥ x18 5x479x37mm

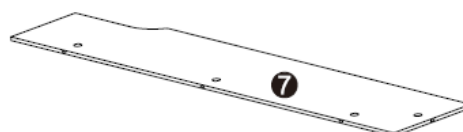

⑦ x1 12x168x803mm

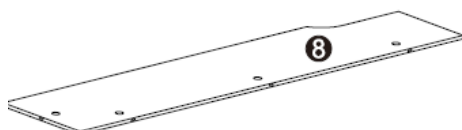

⑧ x1 12x168x803mm

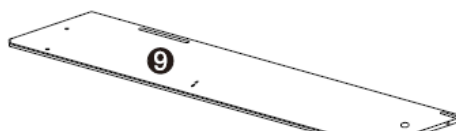

⑨ x1 12x190x760mm

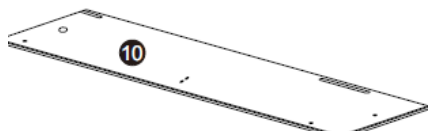

⑩ x1 12x190x760mm



Ax3



Bx20



Cx22



Dx18



Ex36



Fx6



Gx6



Hx2



Ix8

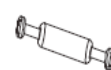

Jx1

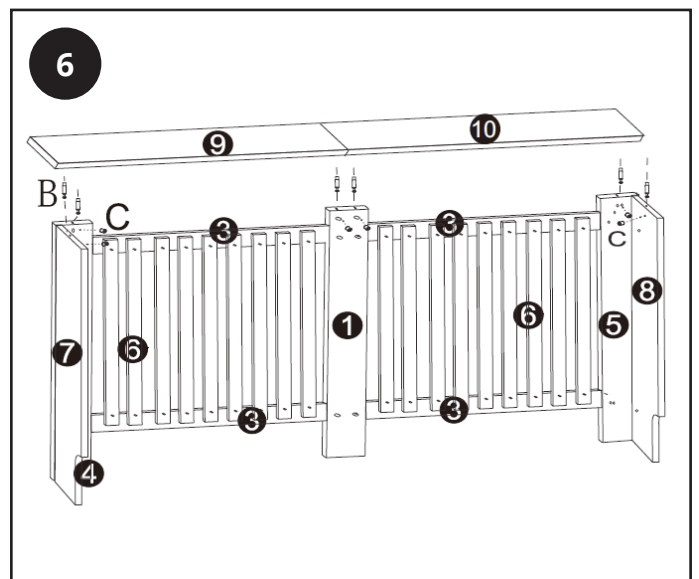
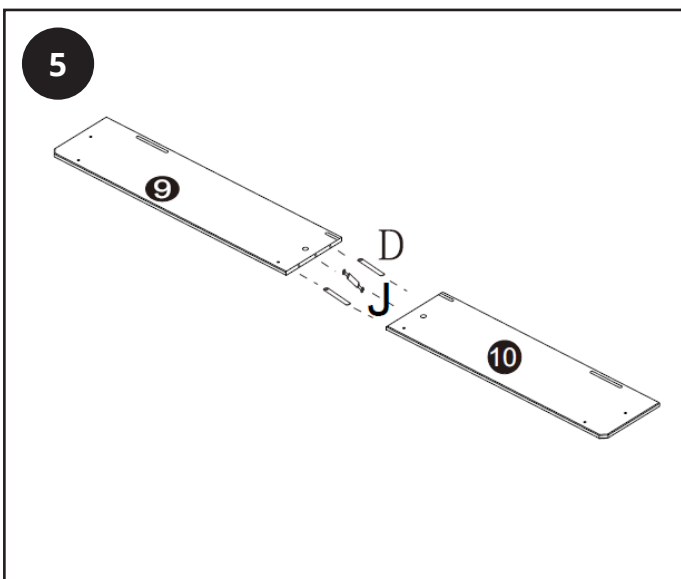
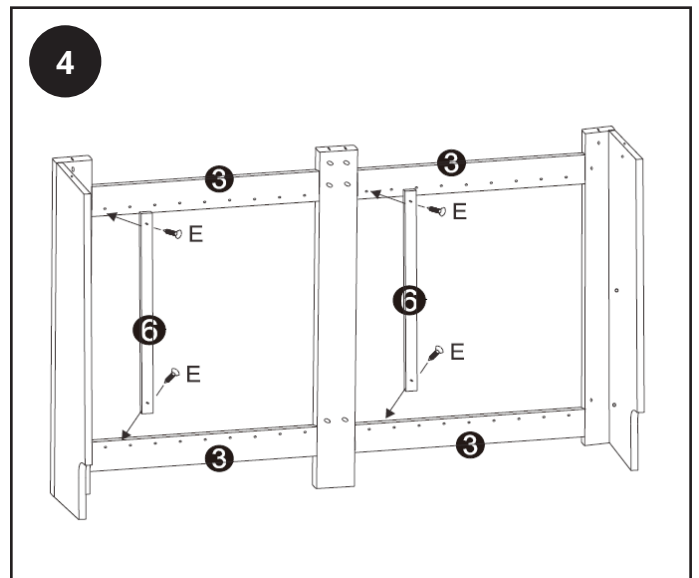
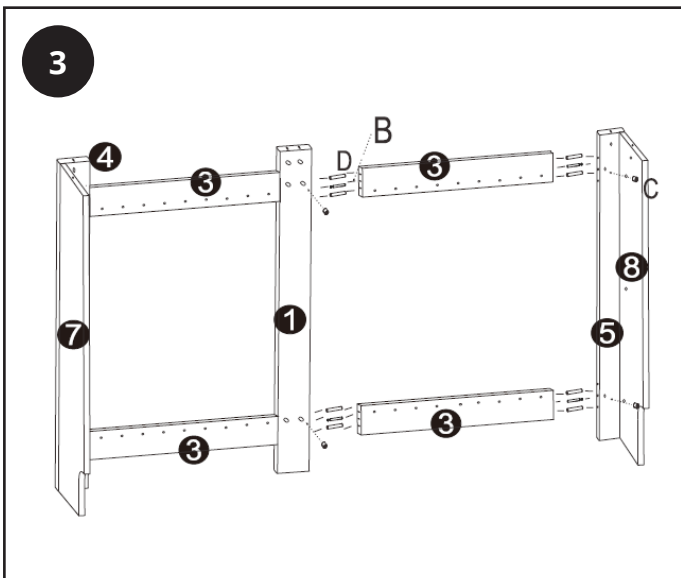
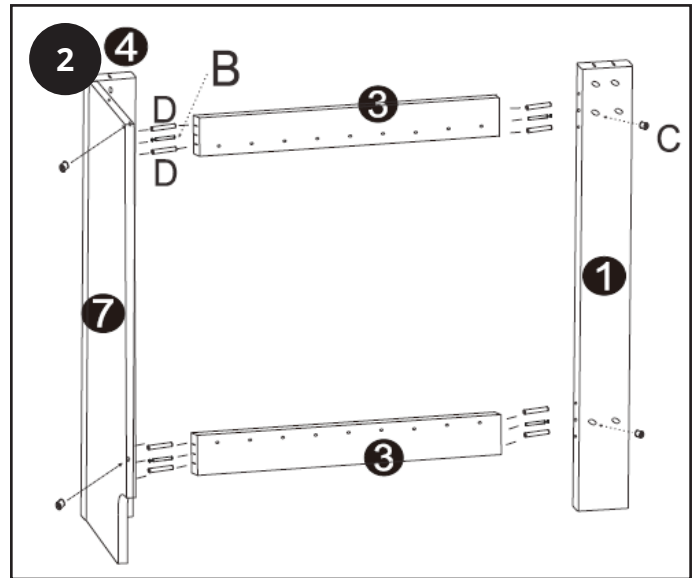
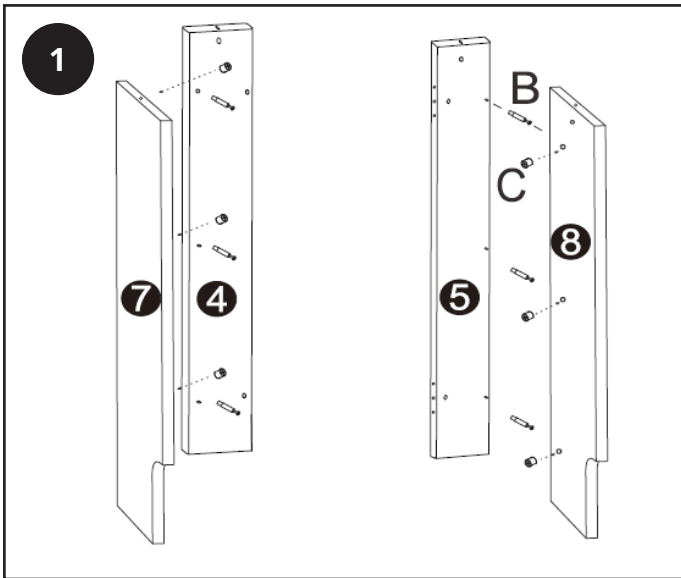

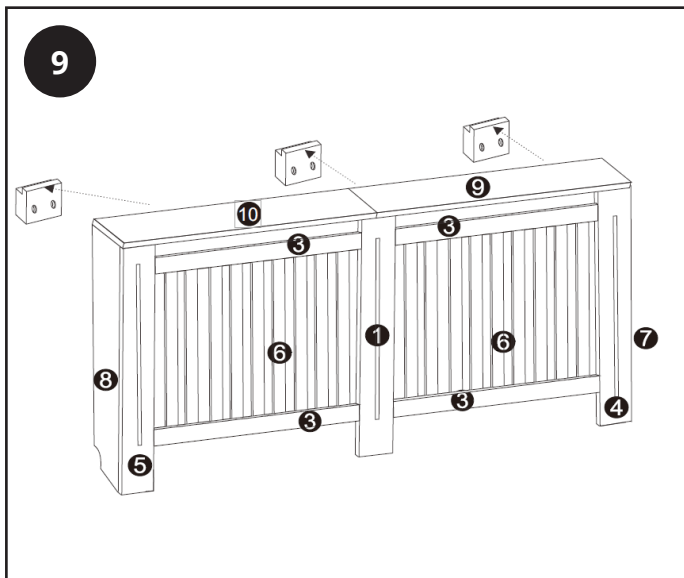
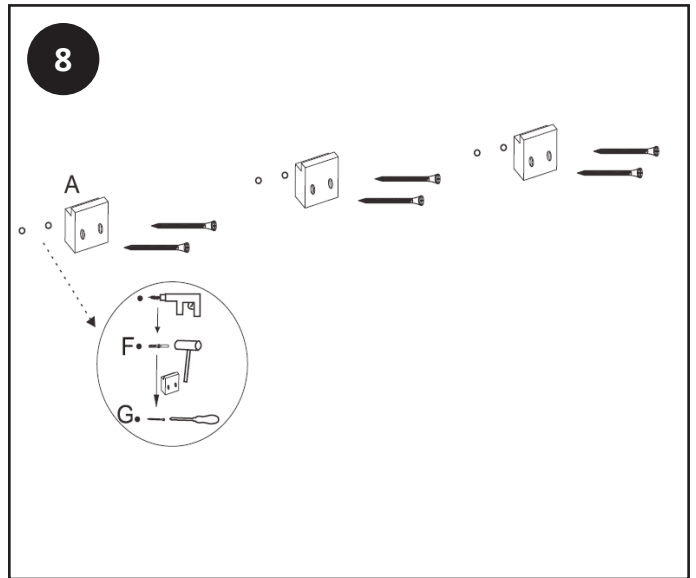
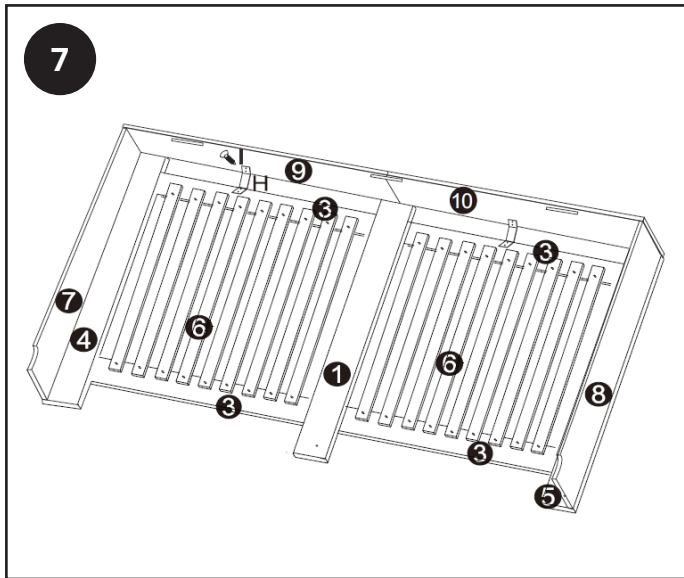

Guarantee Information

- *To find the specific guarantee for your product please refer to the website.*
- *The guarantee starts from the date of purchase.*
- *The guarantee covers you against issues caused as a result of manufacturing related issues, it does not apply to issues that are found to be a result of poor installation.*
- *Labour costs for installation of the Product are not covered under this warranty.*

Aftercare

Clean any marks with a soft dry cloth. DO NOT use abrasive or acidic cleaners, if you are unsure, please contact us first.

Recycling & Disposal

Please recycle / dispose of this product in accordance with your local council / government guidelines.

Contact Us

Milano

Unit 1&2

Dawson court

Burnley

BB11 5UB