









Ficha técnica

Rueda TV-TPG 2-0002

Codigo				Tipo cojinete Eje					
2-0002	100	130	35	—	106x86	86/80x60	8	140	81



Características

Fabricada con chapa de acero embutido hasta 5m/m de espesor.
Acabado bicromatizado de alta resistencia al óxido.
Doble rodamiento a bolas reforzado con pistas de rodadura endurecidas.
Protector anti-polvo en el cojinete del soporte.
Fabricadas según normas europeas en 12532.

Datos técnicos

Diámetro: 100 mm
Carga: 130 kg
Tipo de cojinete: Cojinete Liso
Ancho de Banda de rodadura: 35 mm
Medidas de placa superior: 106x86 mm
Distancia entre agujeros: 86/80x60 mm
Diámetro agujero sujeción platina: 8 mm
Altura total: 140 mm
Radio de giro: 81 mm

Archivos CAD

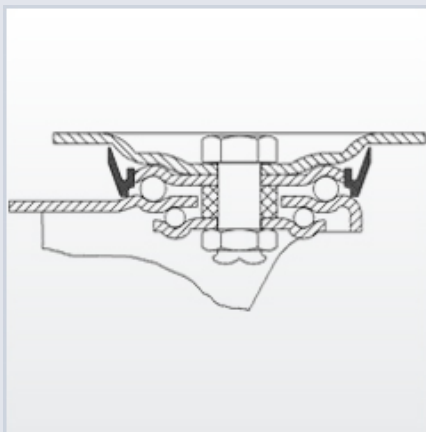

Rueda

TPG (Goma)
Núcleo de nylon negro y banda de goma
Rango de temperatura: -20° ÷ +60°

Productos relacionados

