

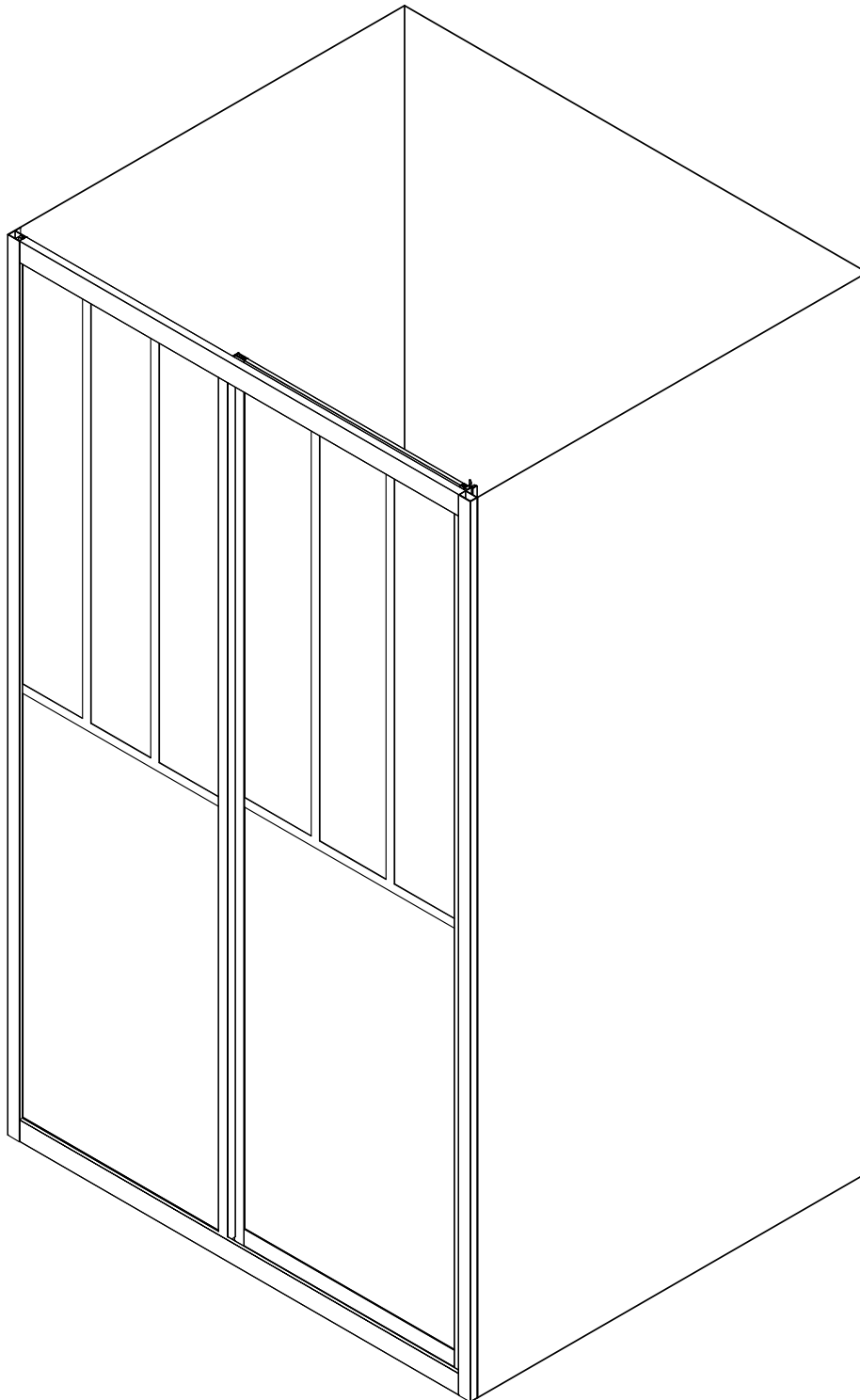

FAC352
1200X2000mm

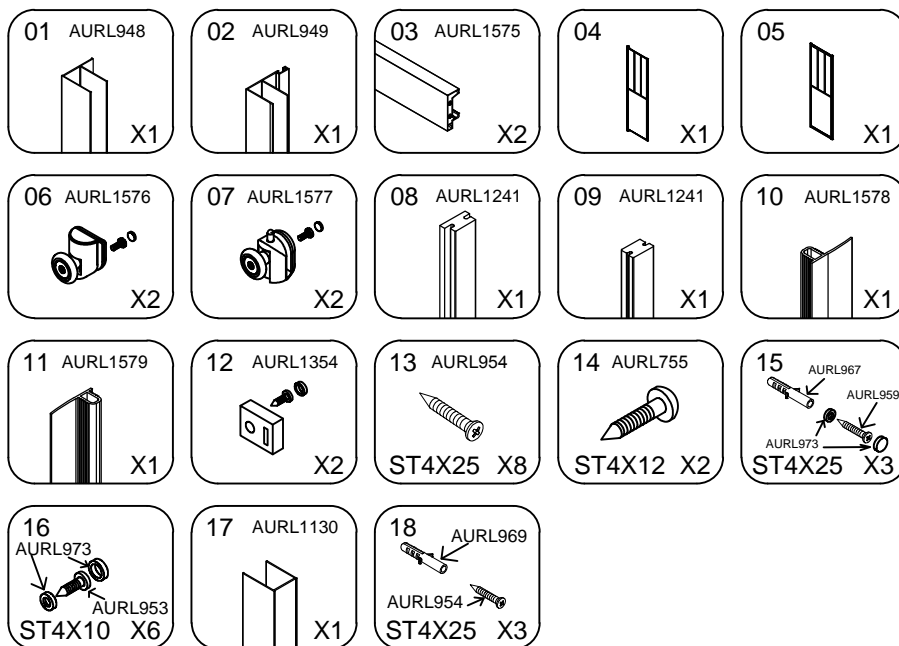

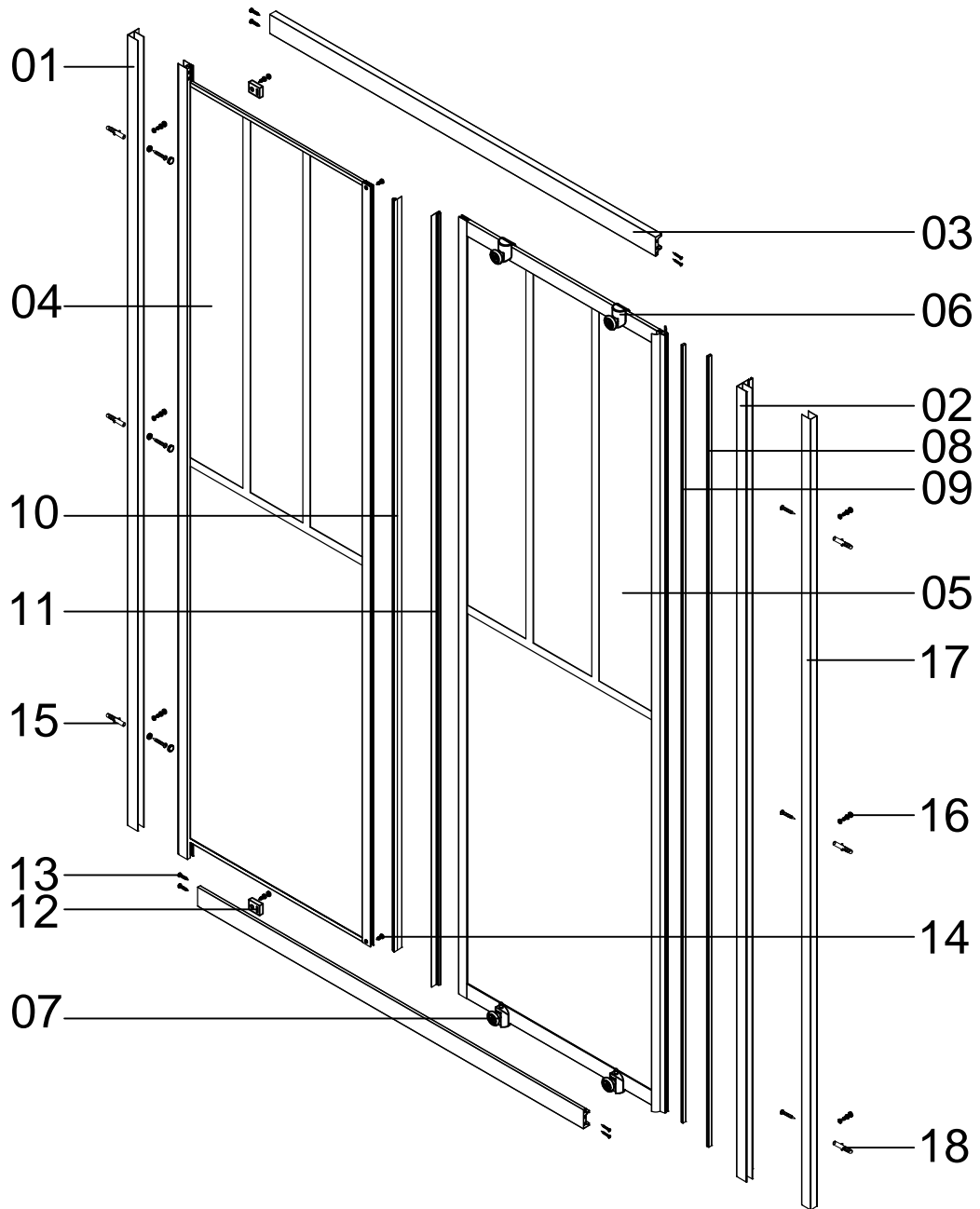

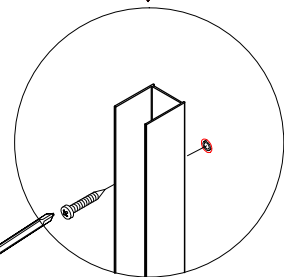
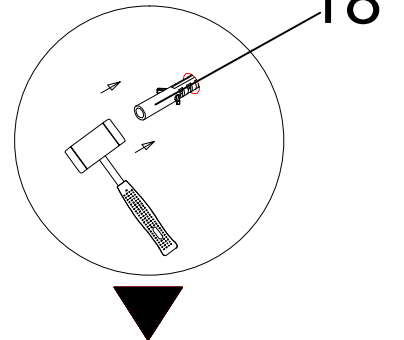
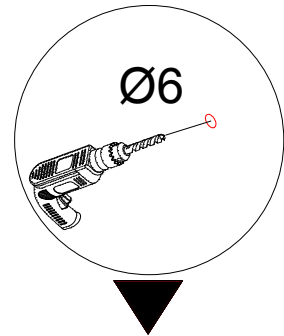
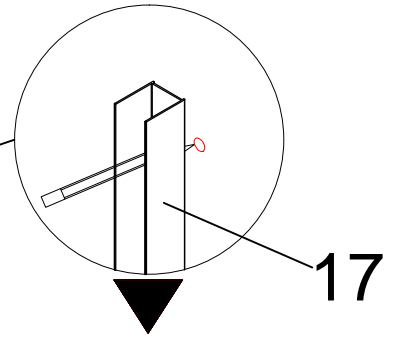
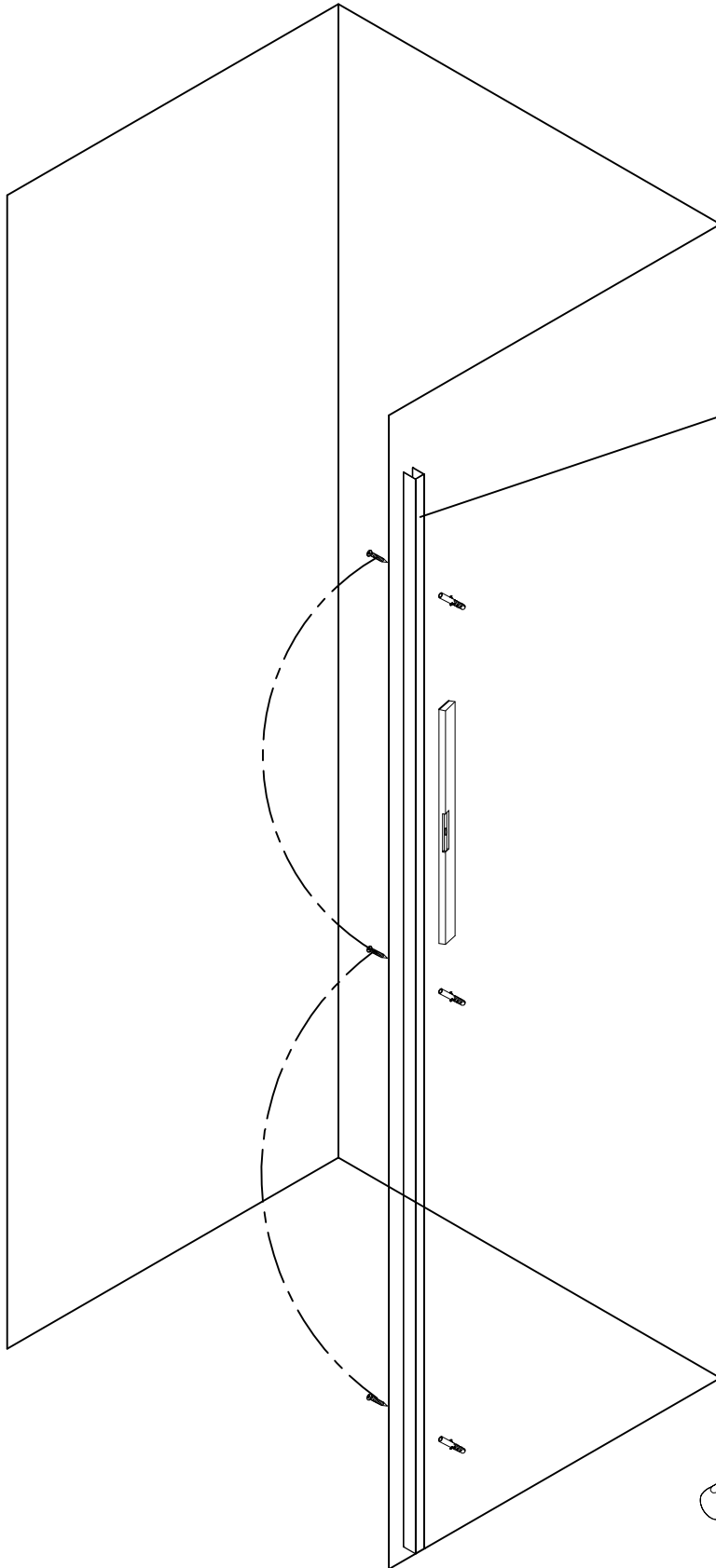
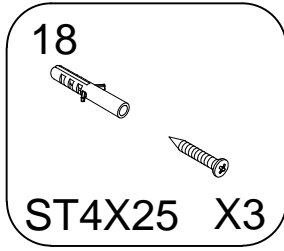
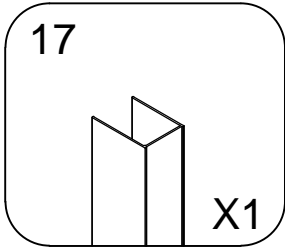

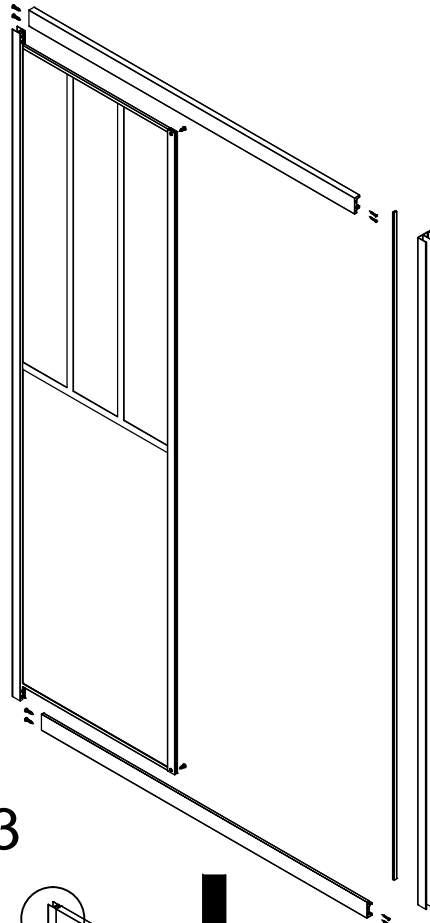
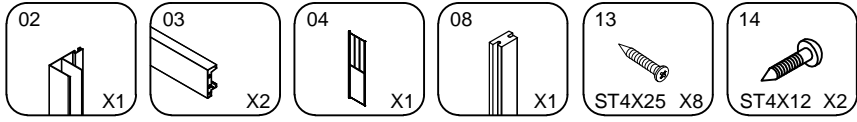

Step 1

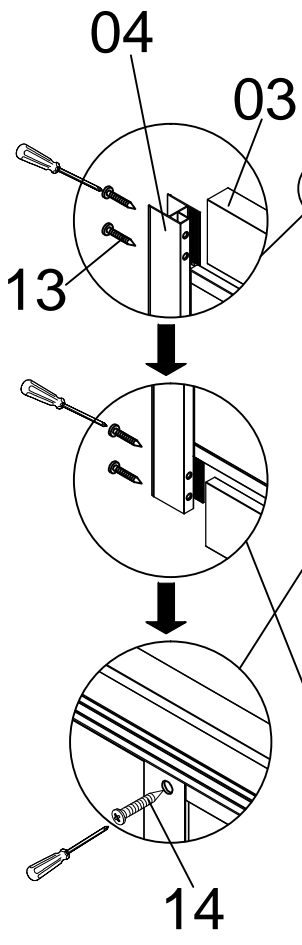

Step 2

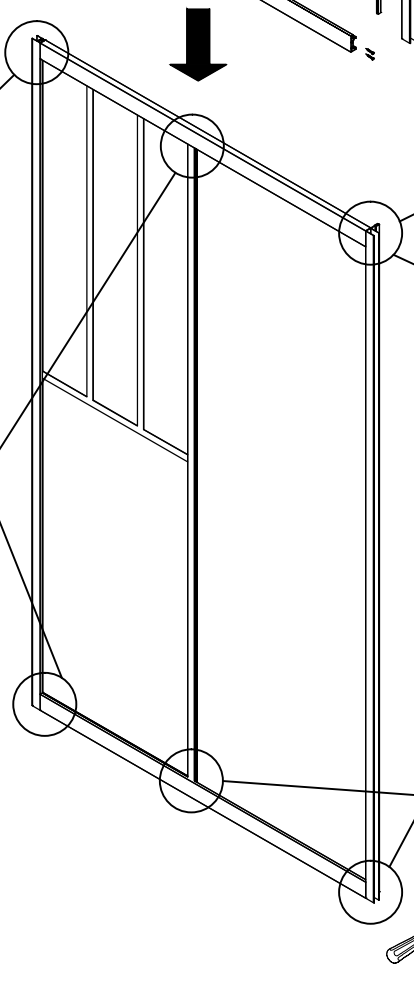
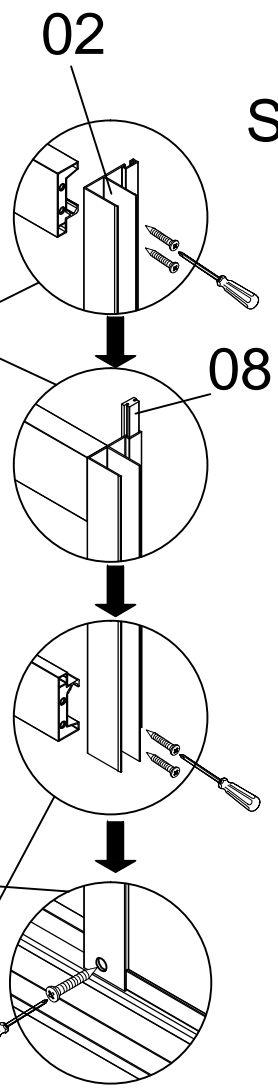

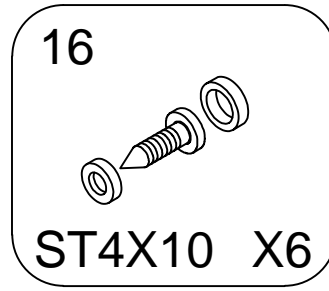
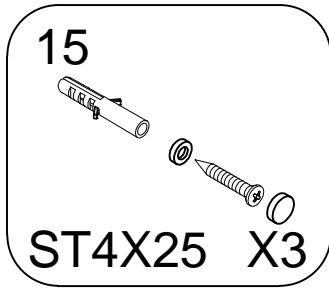
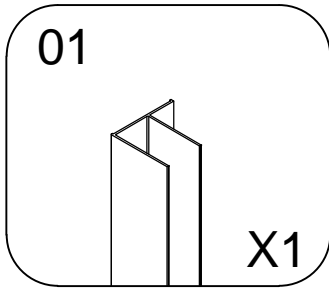

Step 1

01

Step 2

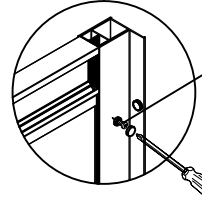
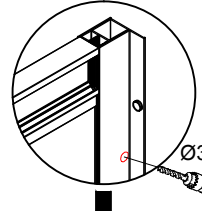
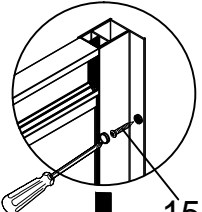
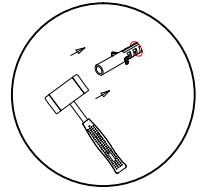
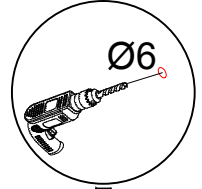
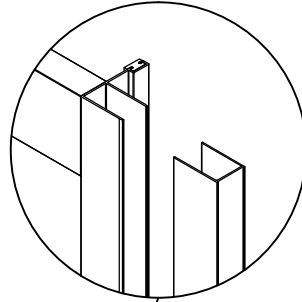
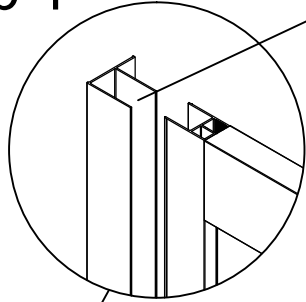
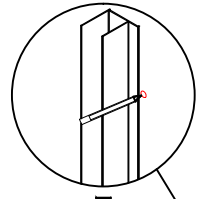

Step 3

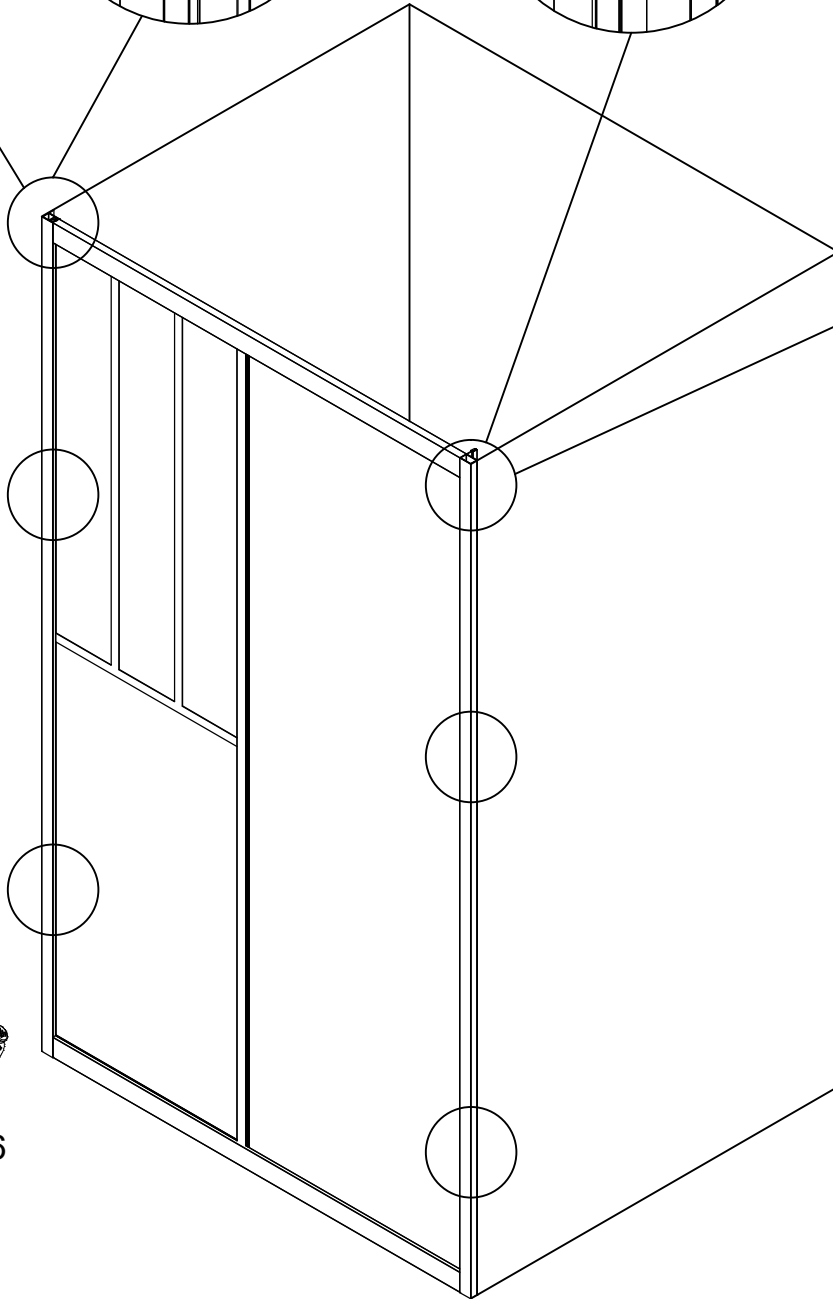
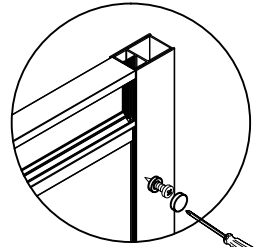
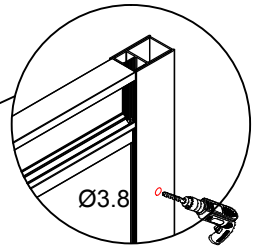

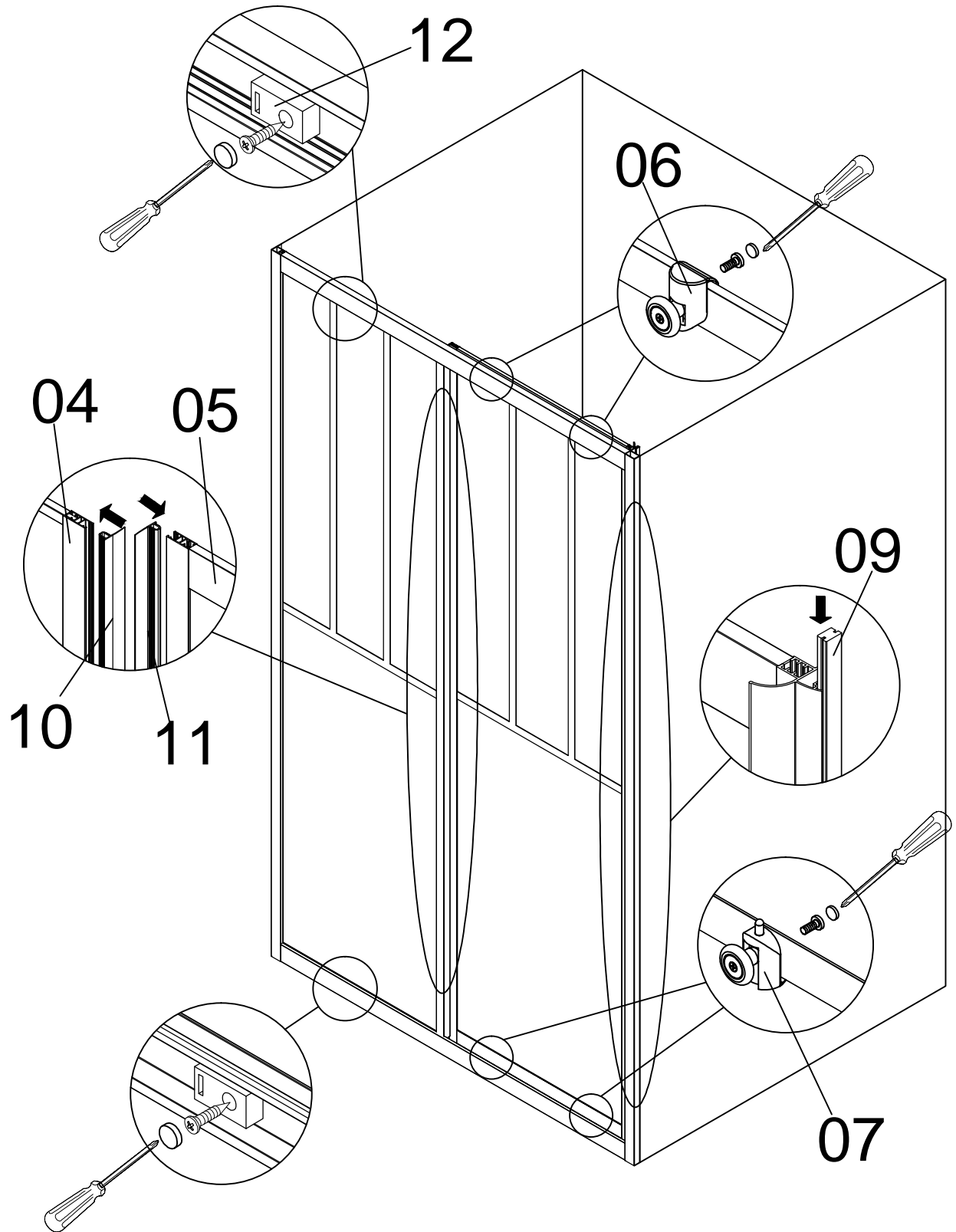
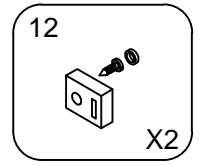
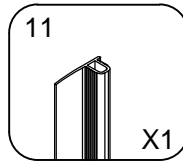
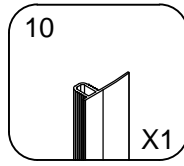
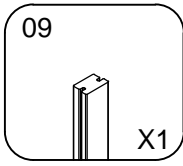
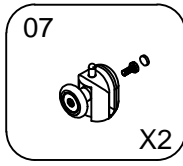
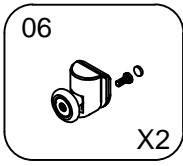
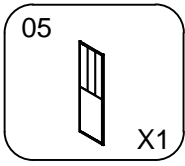

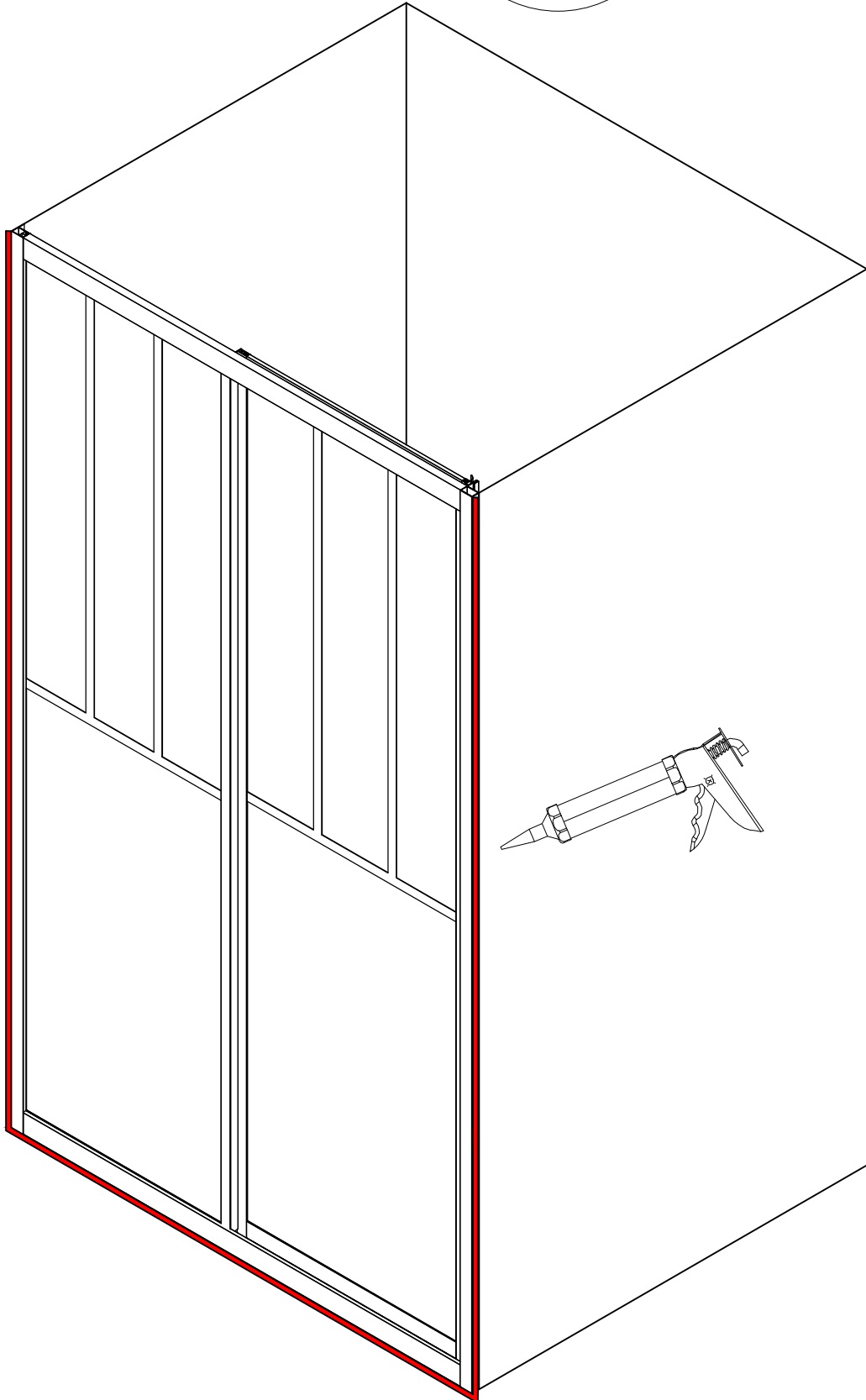
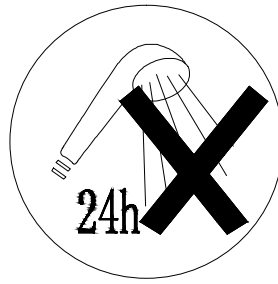
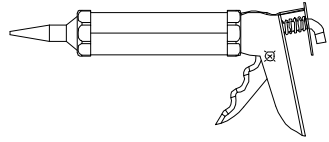

DÉCLARATION DES PERFORMANCES

N o DoP_FAC_025

1. Code d'identification du produit Type : **PAROIS FABRIK - FAC352**

2. Usage(s) prévu(s): PAROIS DE DOUCHE POUR HYGIENE PERSONNEL-PH.....

3. Fabricant :AURLANE 55 rue la condamine 75017 PARIS.....

4. Mandataire :Non applicable.....

5. Système(s) d'évaluation et de vérification de la constance des performances: système 4.....

6a. Norme harmonisée: EN14428:2004

Organisme(s) notifié(s) : Non applicable

6b. Document d'évaluation européen Non applicable

Evaluation technique européenne Non applicable

Organisme d'évaluation technique Non applicable

Organisme(s) notifié(s) Non applicable

7. Performances déclarées

Caractéristiques essentielles	Performances	Spécifications techniques harmonisées
Aptitude au nettoyage	Exigences satisfaites	EN14428:2004+A1:2008 Clause 4.2
Résistance à l'impact / Propriétés d'éclatement	Exigences satisfaites	EN14428:2004+A1:2008 Clause 4.3
Durabilité	Exigences satisfaites	EN14428:2004+A1:2008 Clause 4.4

Les performances du produit identifié ci-dessus sont conformes aux performances déclarées.

Conformément au règlement (UE) n°305/2011, la présente déclaration des performances est établie sous la seule responsabilité du fabricant mentionné ci-dessus.

Signé au nom du fabricant par:

Sébastien Doumenc
Directeur associé Aurlane
A paris, le 01/09/2021



ANEXE MARQUAGE CE



AURLANE
55 rue de la condamine 75017 Paris France

19

EN 14428:2008+A1