



GRD-ROL
09.08.2018

Rouleau de Jardin, rouleau à Gazon en métal **GRD-ROL** Manuel d'utilisation



Avant la mise en service, lisez le mode d'emploi et les consignes de sécurité. Respectez-les. De par l'évolution constante des produits, des différences peuvent apparaître entre ce manuel et votre article. Si vous deviez constater une incohérence, n'hésitez pas à nous contacter, nos coordonnées se trouvant ci-dessous







Made in China





Varan Motors

BCIE SARL, gruuss-strooss 28, 9991 Weiswampach, Luxembourg

T: 00352/26908036 – F: 00352/26908040

Parts list

Belts and nuts			
	Name		quantity
1	Belt M8x45 mm		x 2
2	Belt M8x100 mm		x 2
3	Washer M8		x 4
4	Washer M10		x 4
5	Nut M8		x 4
6	Pin		x 2

Parts list			
	Name		quantity
A	Push bar		x 1
B	Tubular frame left		x 1
C	Tubular frame right		x 1
D	dirt deflector		x 1
E	roller		x 1

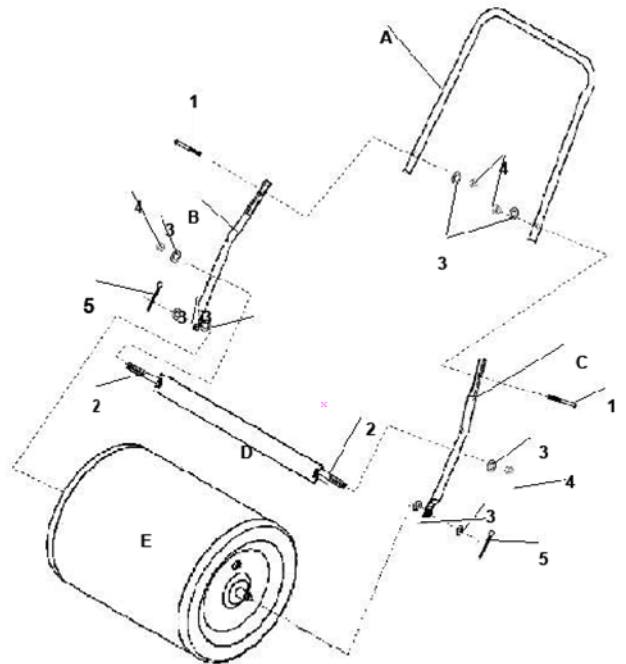
Assembly instruction

1. Screw the push handle (A) with the screw M8x45 mm (1), the washer M8 (3) and the nut M8 (5) to the tube frame to the left (B) and tubular frame right (C).
2. Screw the frame to the left (B) and metal frame on the right (C) with the screws M8x100 mm (2), the M8 washer (3) and the M8 nut (5) on dirt deflector (D) firmly.
3. Attach the finished tube frame on the lawn roller (E), each with 2 washers M10-ben (4) and a locking pin (6).

DESCRIPTIF DE MONTAGE

1. Visser la poignée de poussée (A) avec la vis M8x45mm (1), la rondelle M8 (3) et l'écrou M8 (5) au cadre tubulaire à gauche (B) et au cadre tubulaire à droite (C).
2. Visser le cadre à gauche (B) et le cadre métallique à droite (C) avec les vis M8x100mm (2), la rondelle M8 (3) et l'écrou M8 (5) sur le déflecteur d'impuretés (D).
3. Fixer le cadre tubulaire fini sur le rouleau à gazon (E), chacun avec deux rondelles M10-ben (4) et une goupille de blocage (6).