

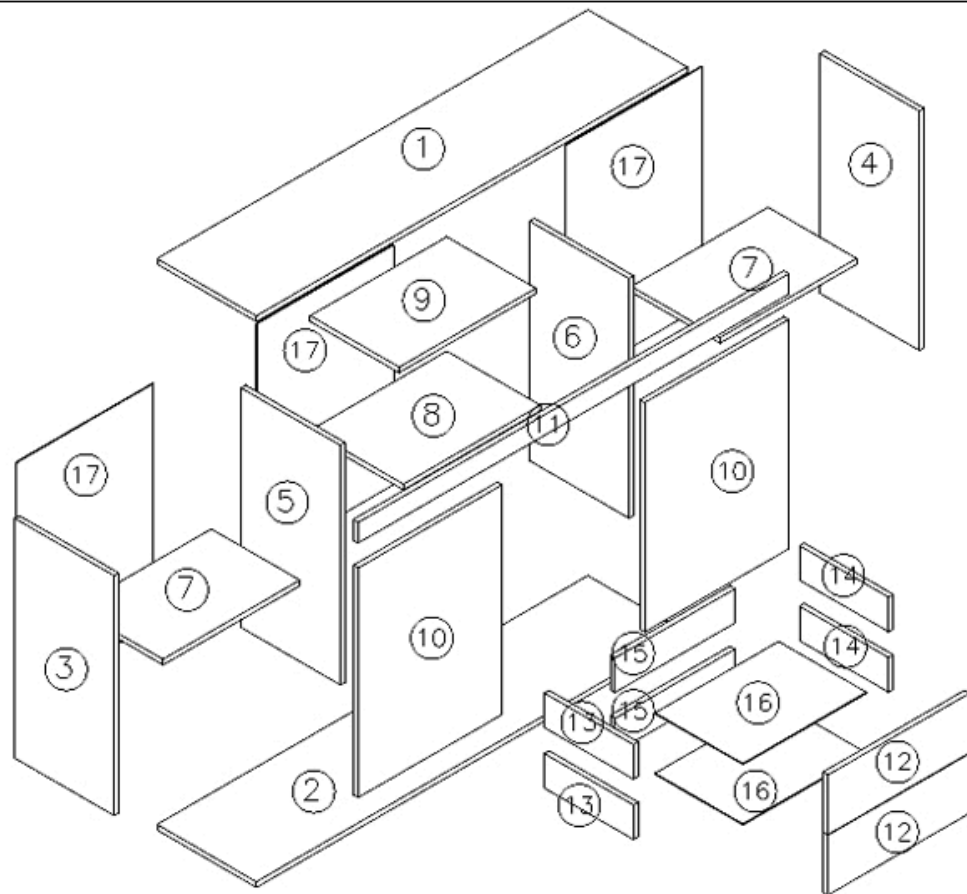

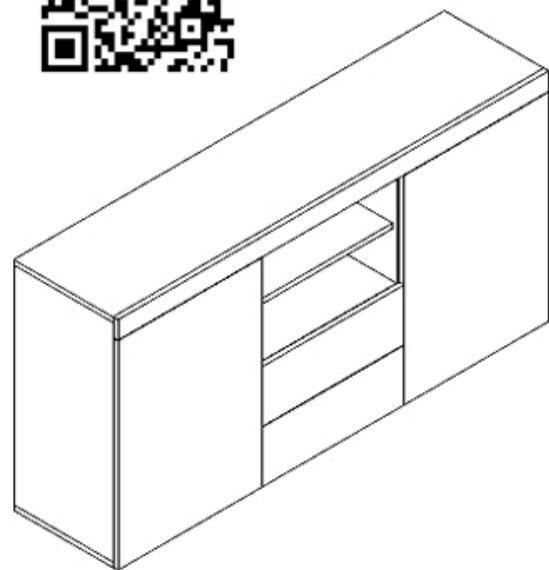





APSD034

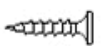
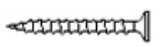
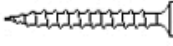

|                                                                                                          |                                                                                                           |                                                                                                                                                                                                                 |                                                                                                                          |                                                                                                                           |                                                                                                                          |                                                                                                            |                                                                                                            |
|----------------------------------------------------------------------------------------------------------|-----------------------------------------------------------------------------------------------------------|-----------------------------------------------------------------------------------------------------------------------------------------------------------------------------------------------------------------|--------------------------------------------------------------------------------------------------------------------------|---------------------------------------------------------------------------------------------------------------------------|--------------------------------------------------------------------------------------------------------------------------|------------------------------------------------------------------------------------------------------------|------------------------------------------------------------------------------------------------------------|
| <p>A</p>  <p>41PCS</p>  | <p>B</p>  <p>32PCS</p> | <p>C</p> <p>C1</p>  <p>C2</p>  <p>2PCS</p> | <p>D</p> <p>3.5*14</p>  <p>40PCS</p> | <p>E</p> <p>3.5*25</p>  <p>10PCS</p> | <p>F</p> <p>3.5*35</p>  <p>8PCS</p> | <p>G</p>  <p>4PCS</p> | <p>H</p>  <p>8PCS</p> |
| <p>I</p>  <p>4PCS</p> | <p>J</p>  <p>4PCS</p>  | <p>K</p>  <p>5PCS</p>                                                                                                        |                                                                                                                          |                                                                                                                           |                                                                                                                          |                                                                                                            |                                                                                                            |

1

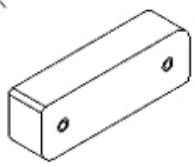
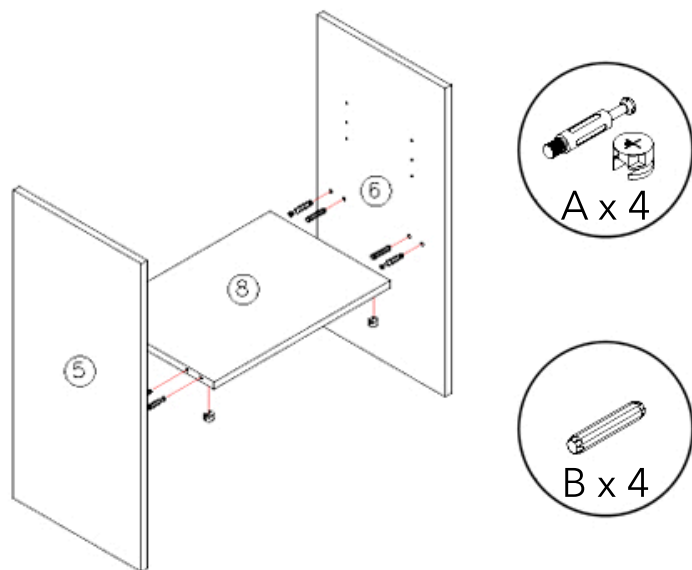

A\*4 B\*4

2

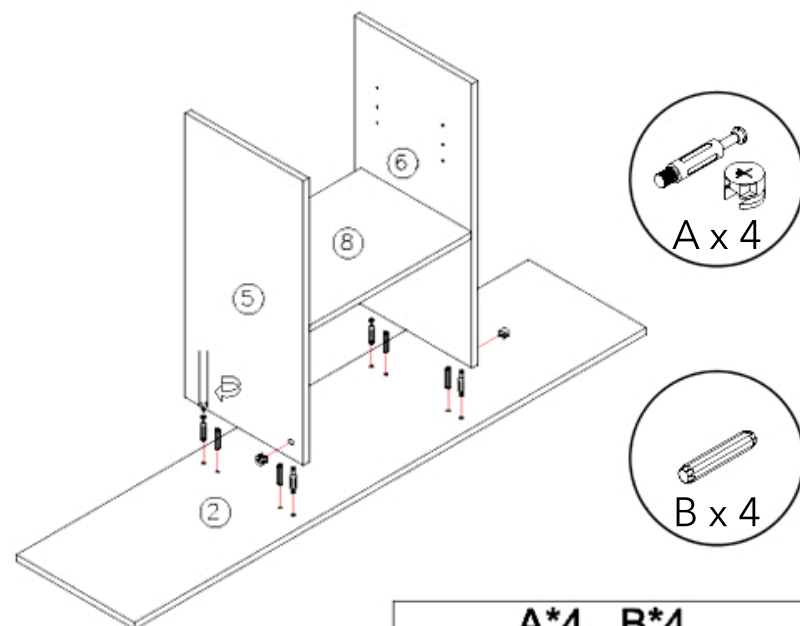

A\*4 B\*4

3

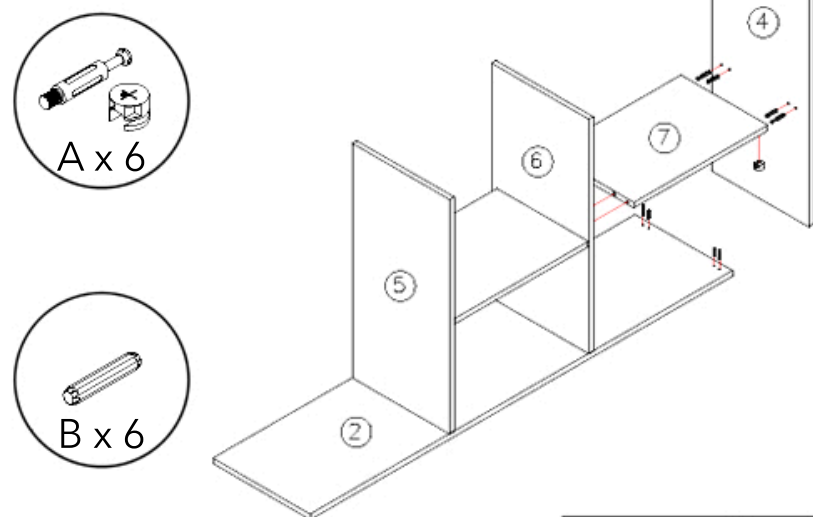

A\*6 B\*6

4

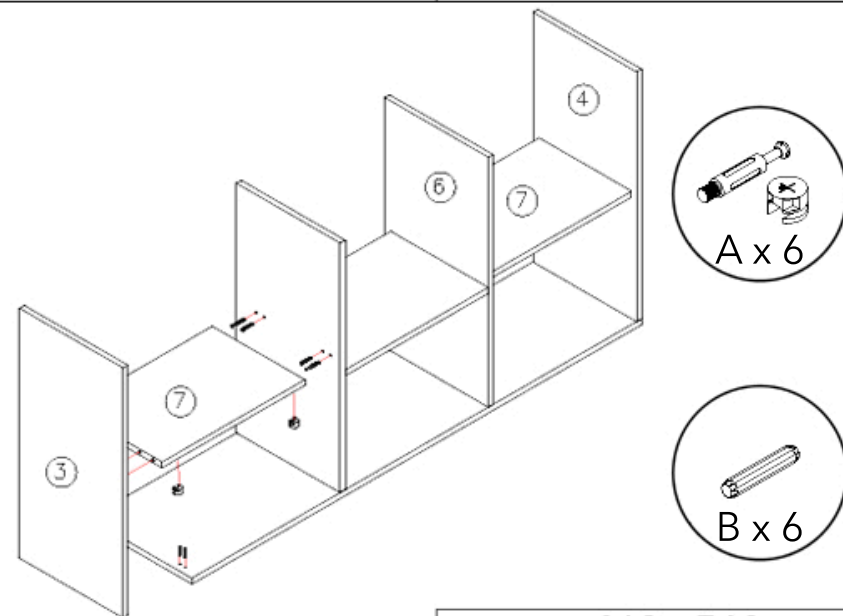

A\*6 B\*6

5

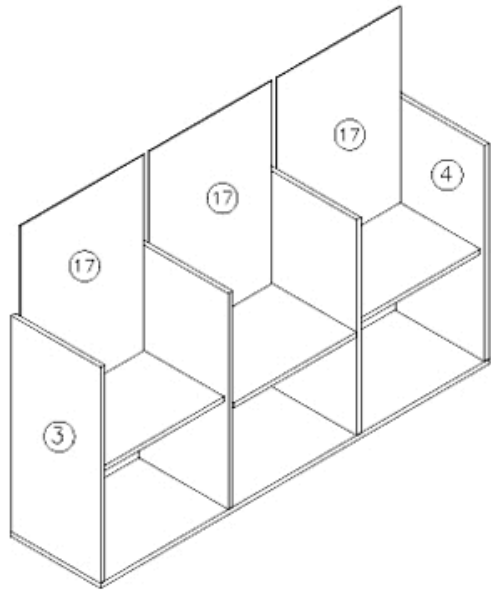

6

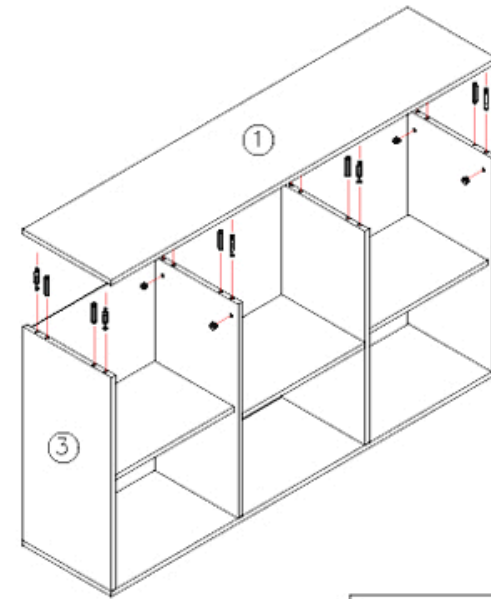

A\*8 B\*8

7

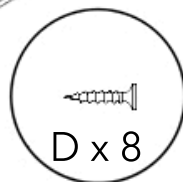
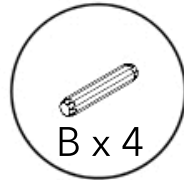
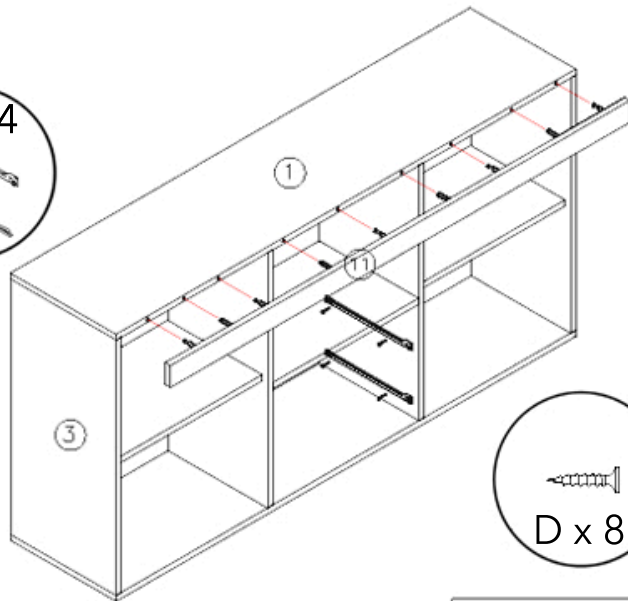

A\*5 B\*4 C1\*4 D\*8

8

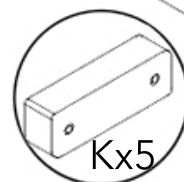
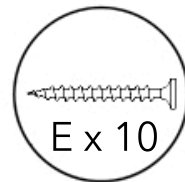
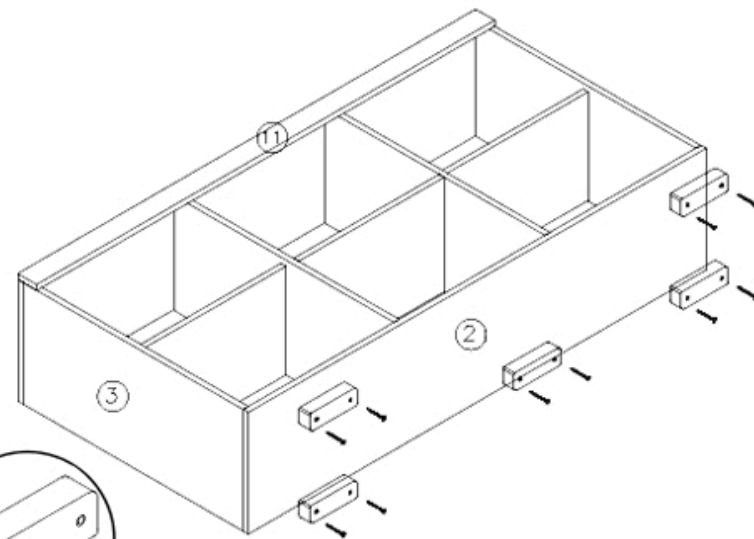

E\*10 K\*5

