

Pola

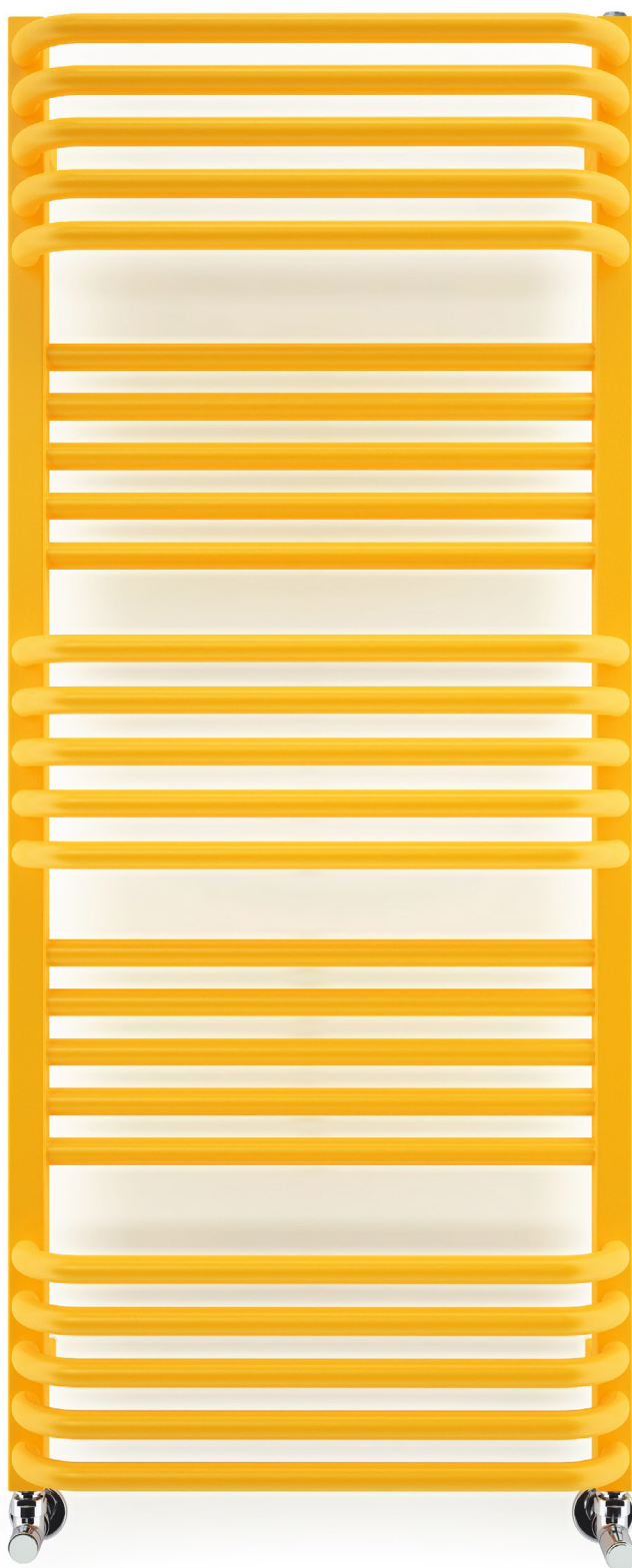

RAL 1033

Pola

Raccordements

Chauffage central



Électrique



Mixte



Dimensions disponibles

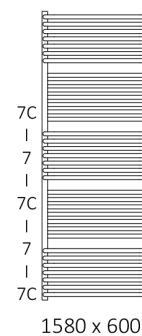
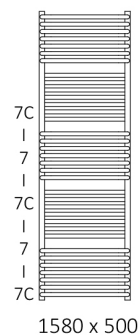
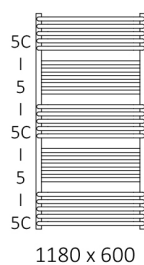
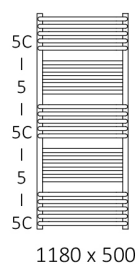
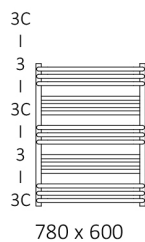
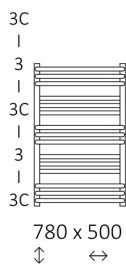

Dimensions disponibles :



Pola

Données techniques

Pression du travail : 1,0 MPa Température maximale de travail : 95°C

A ↓	B ↔	C1 [mm]	C2 [mm]	75 65 20°C [W]	55 45 20°C [W]	 [W]	D [mm]	E [mm]	F [mm]	 [dm³]	 [kg]
Peinture epoxy											
780	500	50	470	392	211	400	470	600	90	3,34	6,72
780	600	50	570	471	254	400	570	600	90	3,79	7,68
1180	500	50	470	638	342	600	470	1000	90	5,39	10,84
1180	600	50	570	766	411	800	570	1000	90	6,14	12,44
1580	500	50	470	883	473	800	470	1400	90	7,44	14,96
1580	600	50	570	1061	568	1000	570	1400	90	8,49	17,20
Revêtement galvanique											
780	500	50	470	274	140	300	470	600	90	3,34	6,72
780	600	50	570	330	168	300	570	600	90	3,79	7,68
1180	500	50	470	447	228	400	470	1000	90	5,39	10,84
1180	600	50	570	536	273	600	570	1000	90	6,14	12,44
1580	500	50	470	618	315	600	470	1400	90	7,44	14,96
1580	600	50	570	743	379	800	570	1400	90	8,49	17,20

Pola

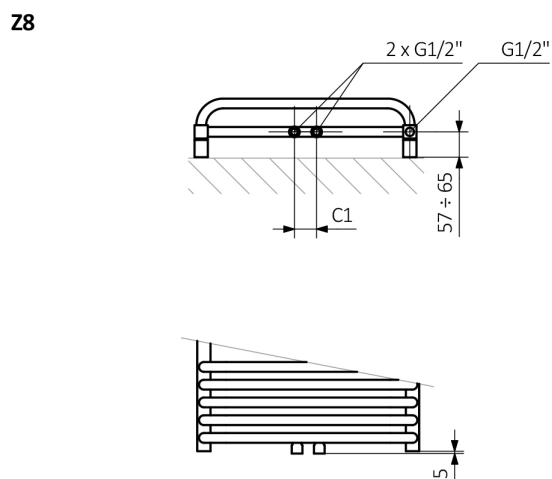
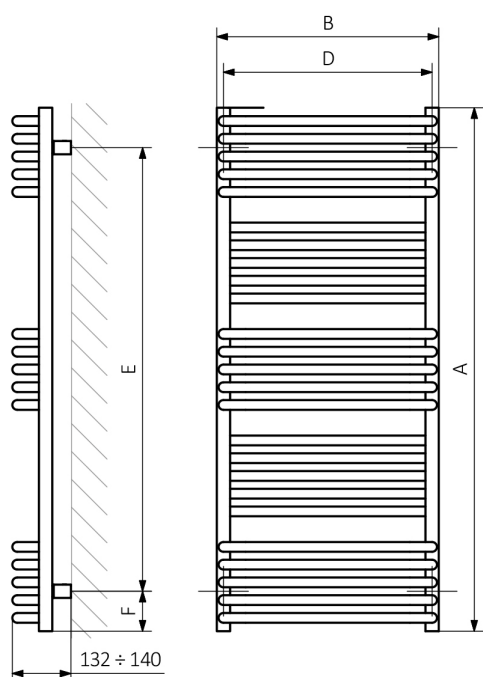
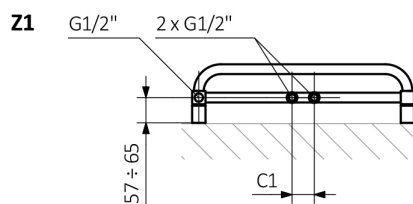
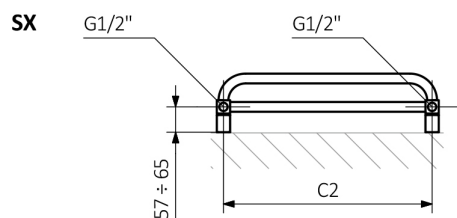

A – hauteur B – largeur C1-C5 – écartement des raccords D – écartement des consoles en horizontal E – écartement des consoles en vertical F – distance de l'axe de la console inférieure au bord inférieur du collecteur

Collecteur :

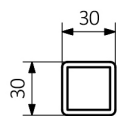

Profil :

