

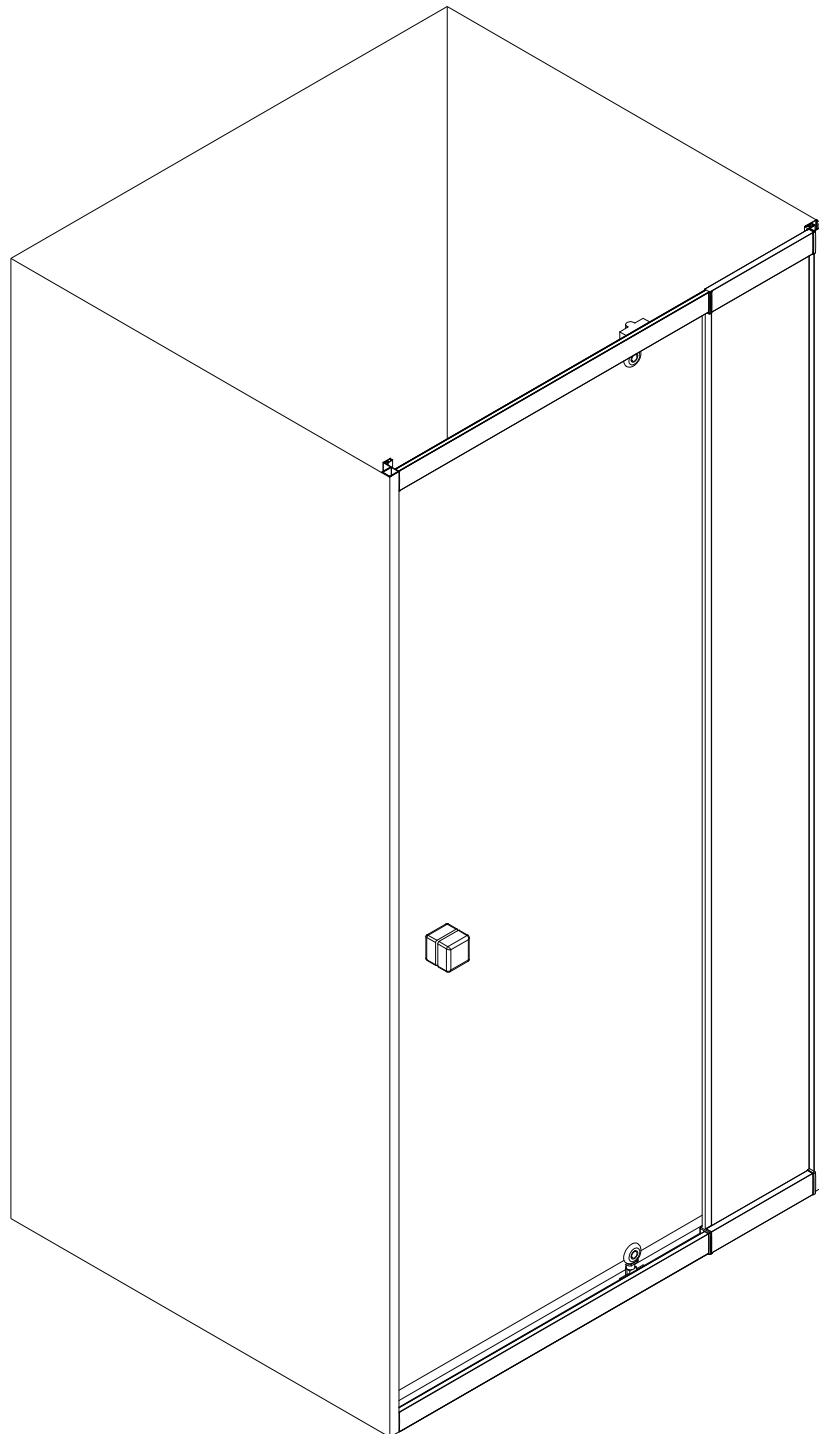

**SPOT PIVOTANTE 80 90**  
**FAC496**  
**(780-900) X1850mm**











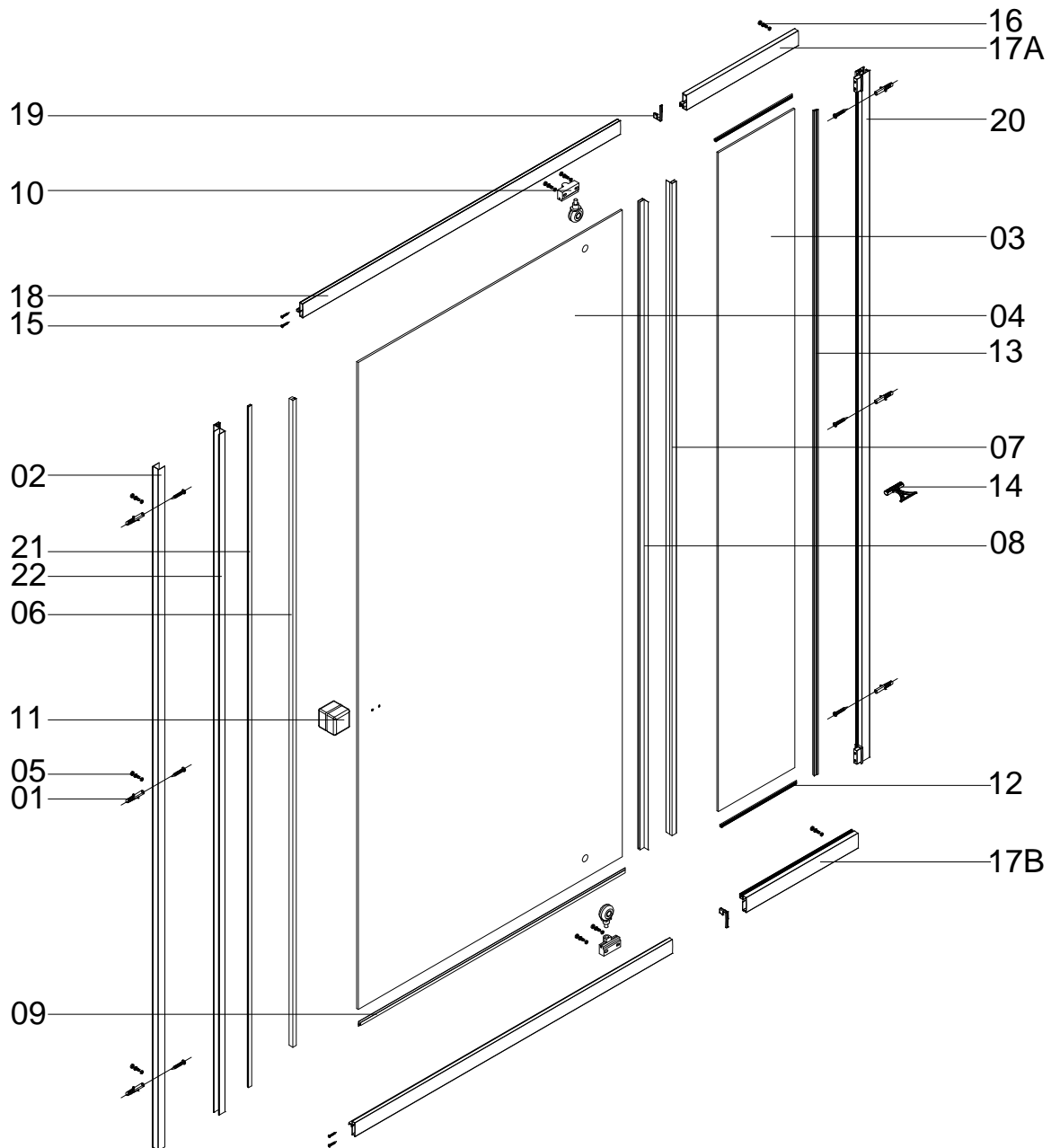









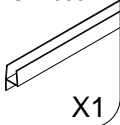





A lire obligatoirement avant installation

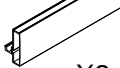
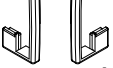

- 1/ Les produits AURLANE sont **garantis 1 an pièces uniquement**. La main d'œuvre n'étant pas effectuée par nos soins, aucune garantie main d'œuvre ne sera appliquée. En cas de défaut de fabrication avéré ou de casse, ces éléments peuvent être commandés au distributeur ayant vendu ce produit, cependant en aucun cas la main d'œuvre relative à ~~un remplacement de la pièce~~ ne sera prise en charge
- 2/ Il est indispensable de vérifier l'état de chacun des éléments au déballeage. Aucune réclamation relative à la qualité du produit ne sera prise en compte passé un délai de 07 jours après l'achat du produit.
- 3/Ce produit doit être installé par un plombier qualifié afin d'éviter tout risque de malfaçon. Notre société décline toute responsabilité dans le cas où il serait installé par du personnel non qualifié.
- 4/ Les éléments en verre sont en verre trempé pour des raisons de normes et de sécurité. Le verre trempé étant conçu pour exploser en morceaux (non coupants) en cas de choc, ces éléments sont à manipuler avec une extrême précaution. Pour cette même raison, il est indispensable de ne pas forcer le serrage des accessoires à fixer sur les éléments vitrés (poignées de portes, étagères, support de douchette, porte serviette, etc)
- 5/ Attention à ne pas utiliser d'agents de nettoyage contenant de l'acétone, du chlore ou de l'eau ammoniacale (eau de javel). Toute utilisation d'un tel produit entraînerait automatiquement une détérioration rapide des éléments chromés (ex: buses de massage, robinetterie, douchette, profils aluminium,.....)
- 6/ Afin de vous prévenir contre toute infection bactérienne, il est important de nettoyer de façon régulière votre produit.



01 AURL1345  ST4X25 X6	02 AURL1358  X1	03  X1	04  X1	05 AURL1359  ST4X10 X3	06 AURL1367  X1	
07 AURL002  X1	08 AURL002  X1	09 AURL393  X1	10 AURL1370  X2	11 AURL1351  ST4X40 X1	12 AURL722  X2	
13 AURL1352  X1	14 AURL826  X1	15 AURL1363  ST3.5X25X4	16 AURL1347  ST4X8 X2	17A AURL1364  X1	17B AURL1364  X1	18 AURL1364  X2
19 AURL1356  X1	20 AURL1346  X1	21 AURL1365  X1	22 AURL1366  X1			

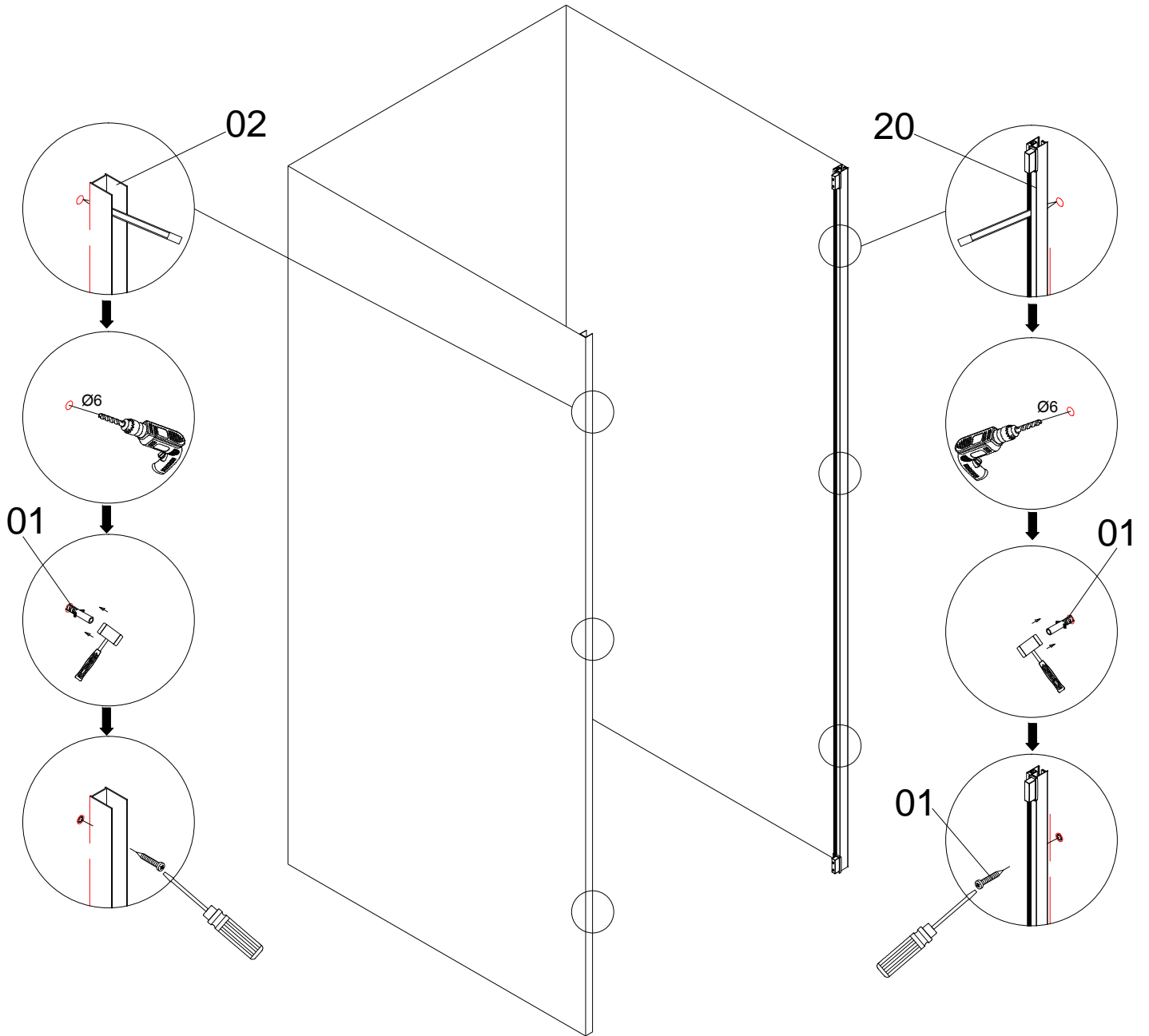
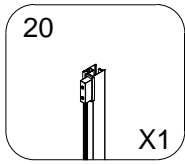
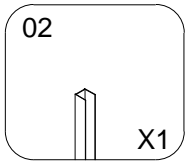
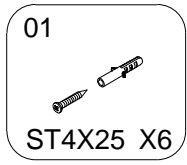

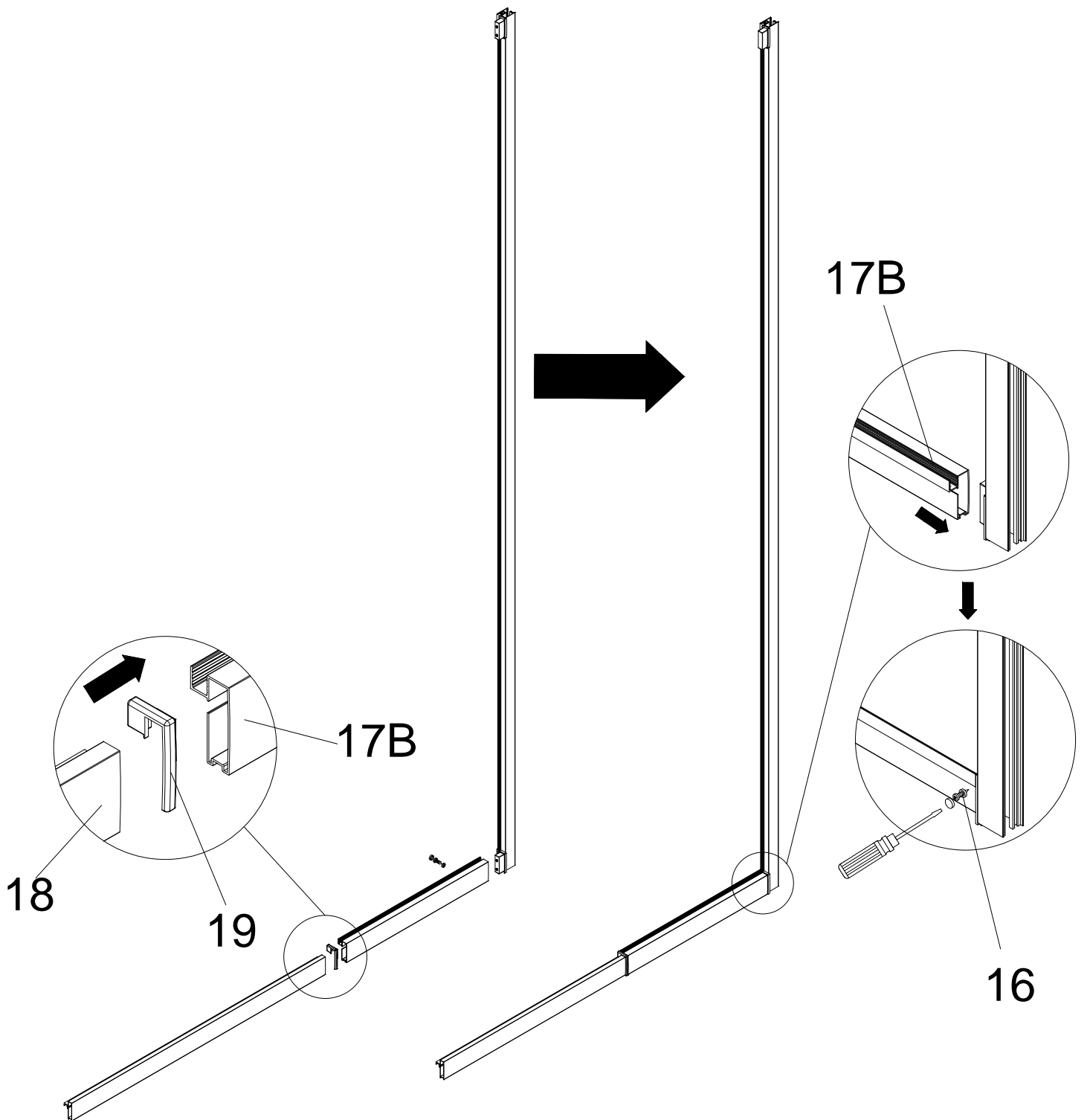
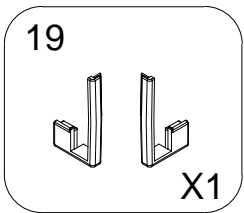
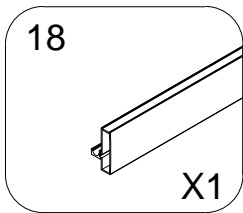
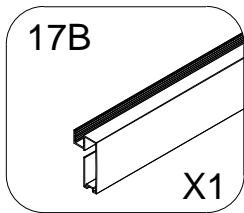
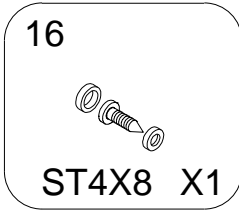

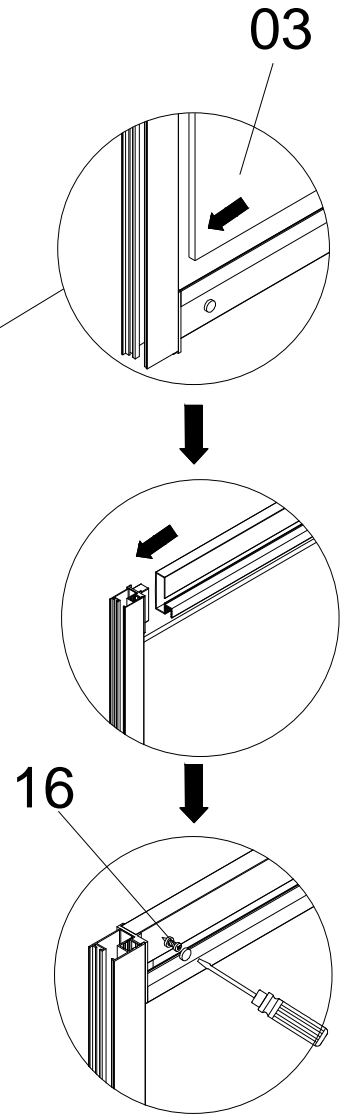
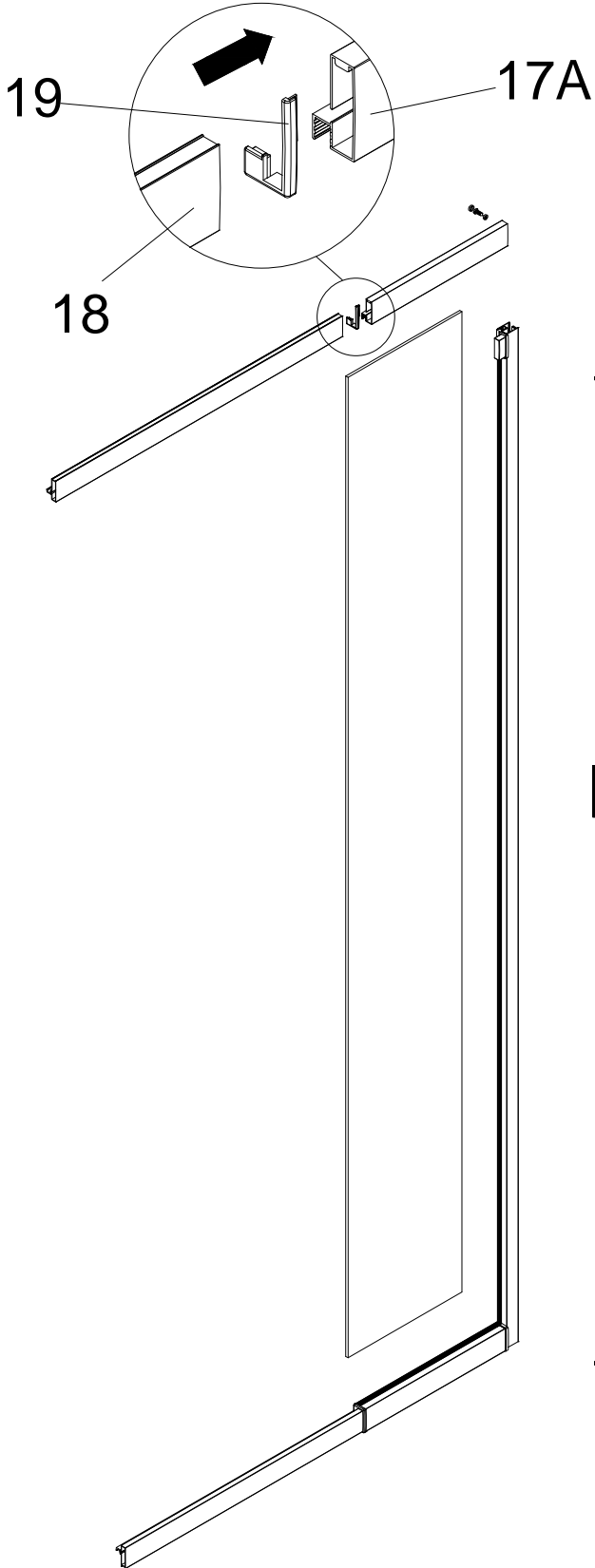
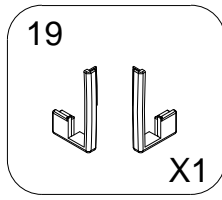
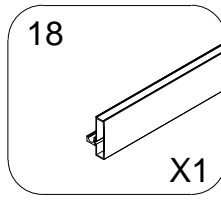
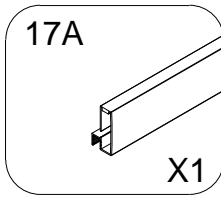
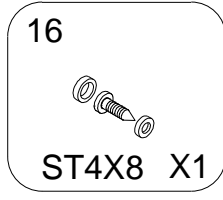
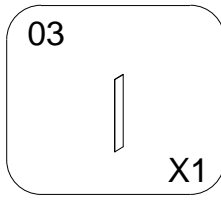

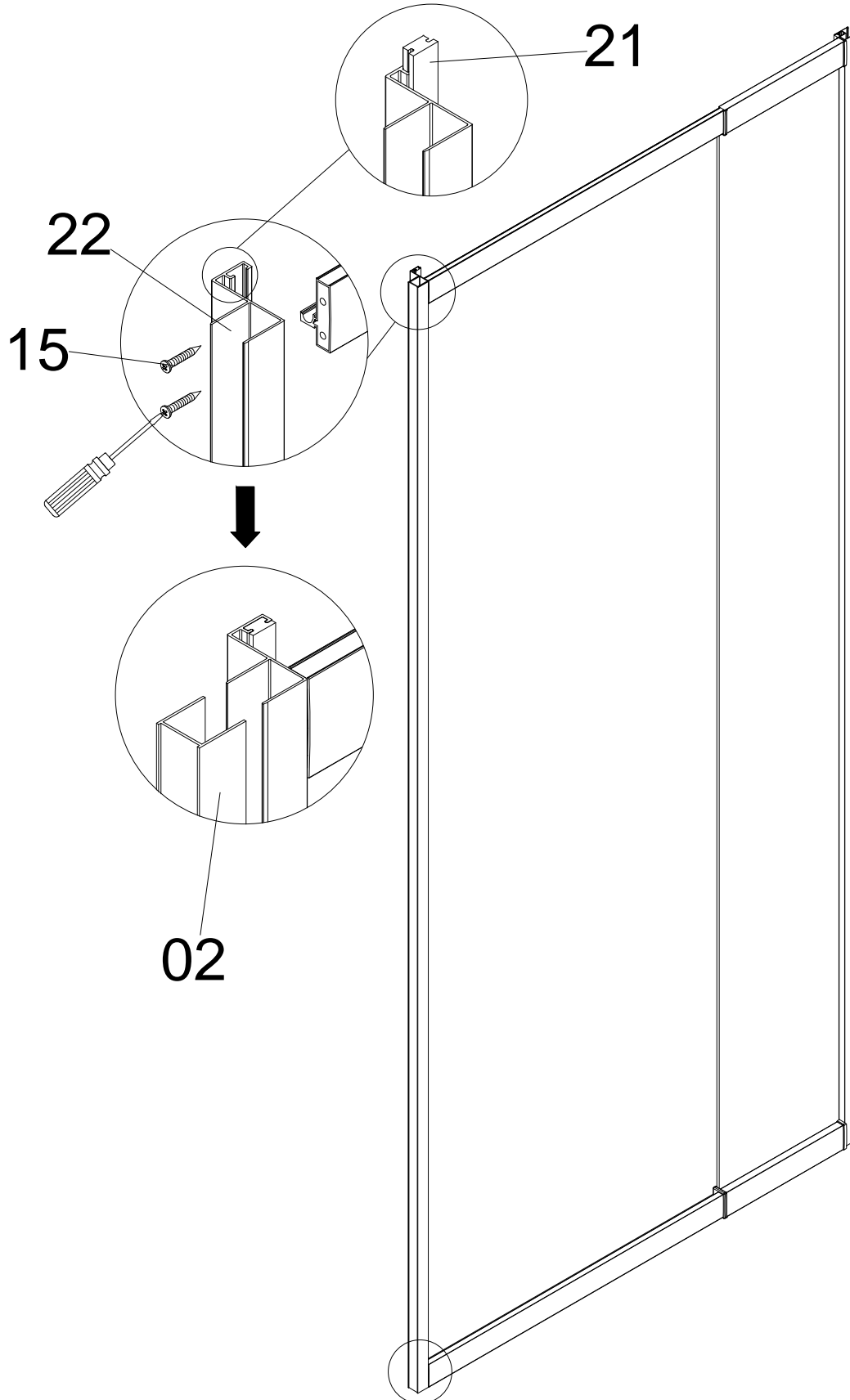
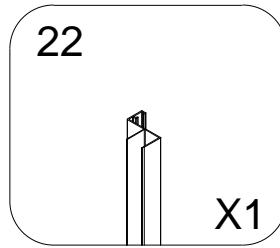
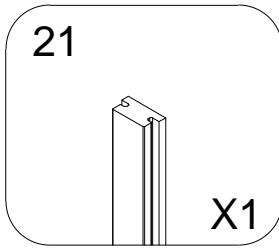

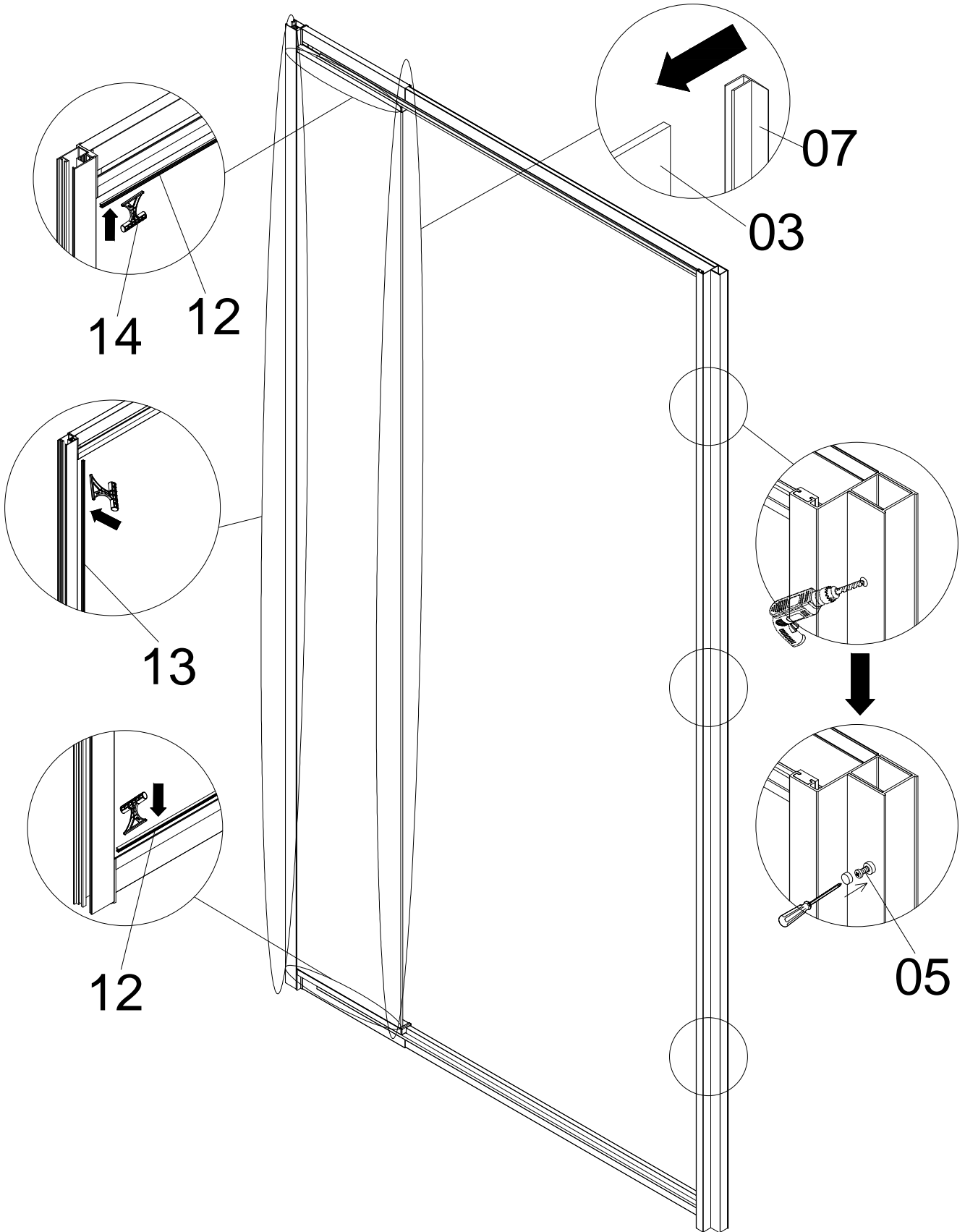
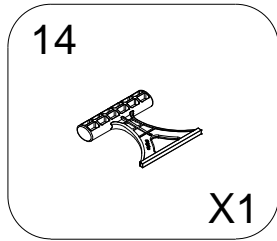
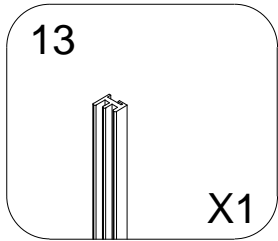
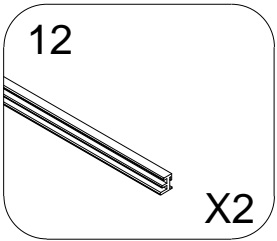
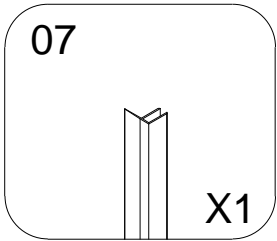
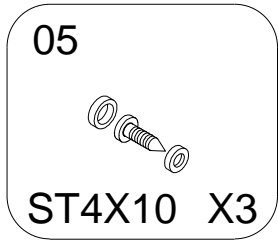



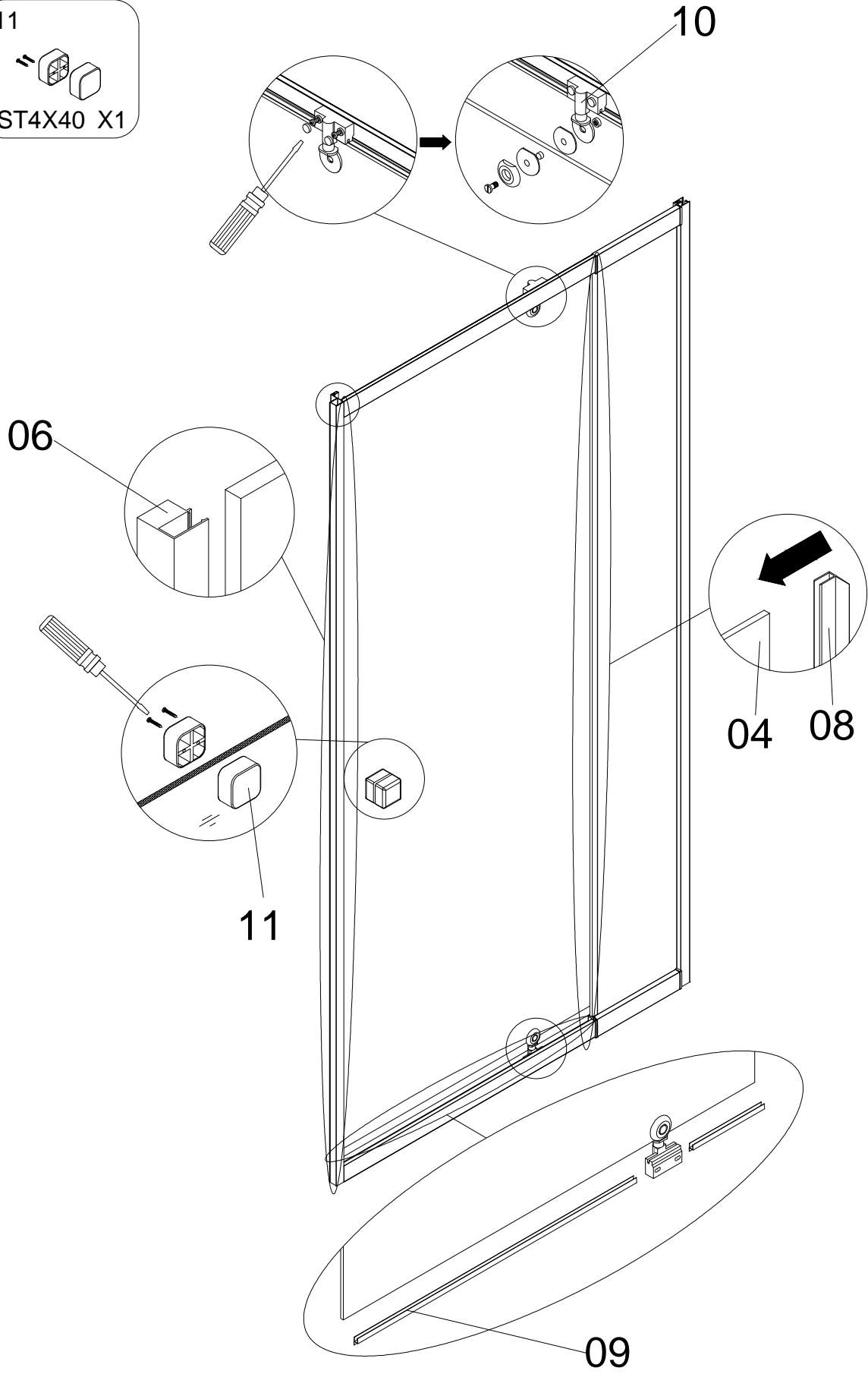
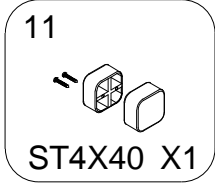
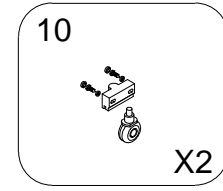
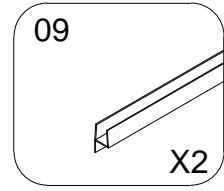
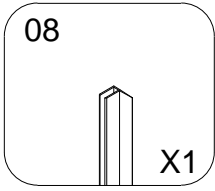
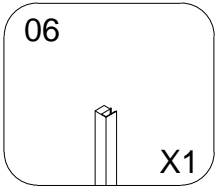
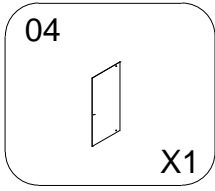

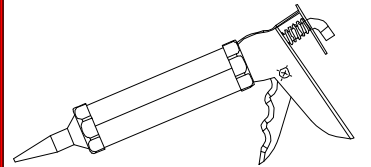
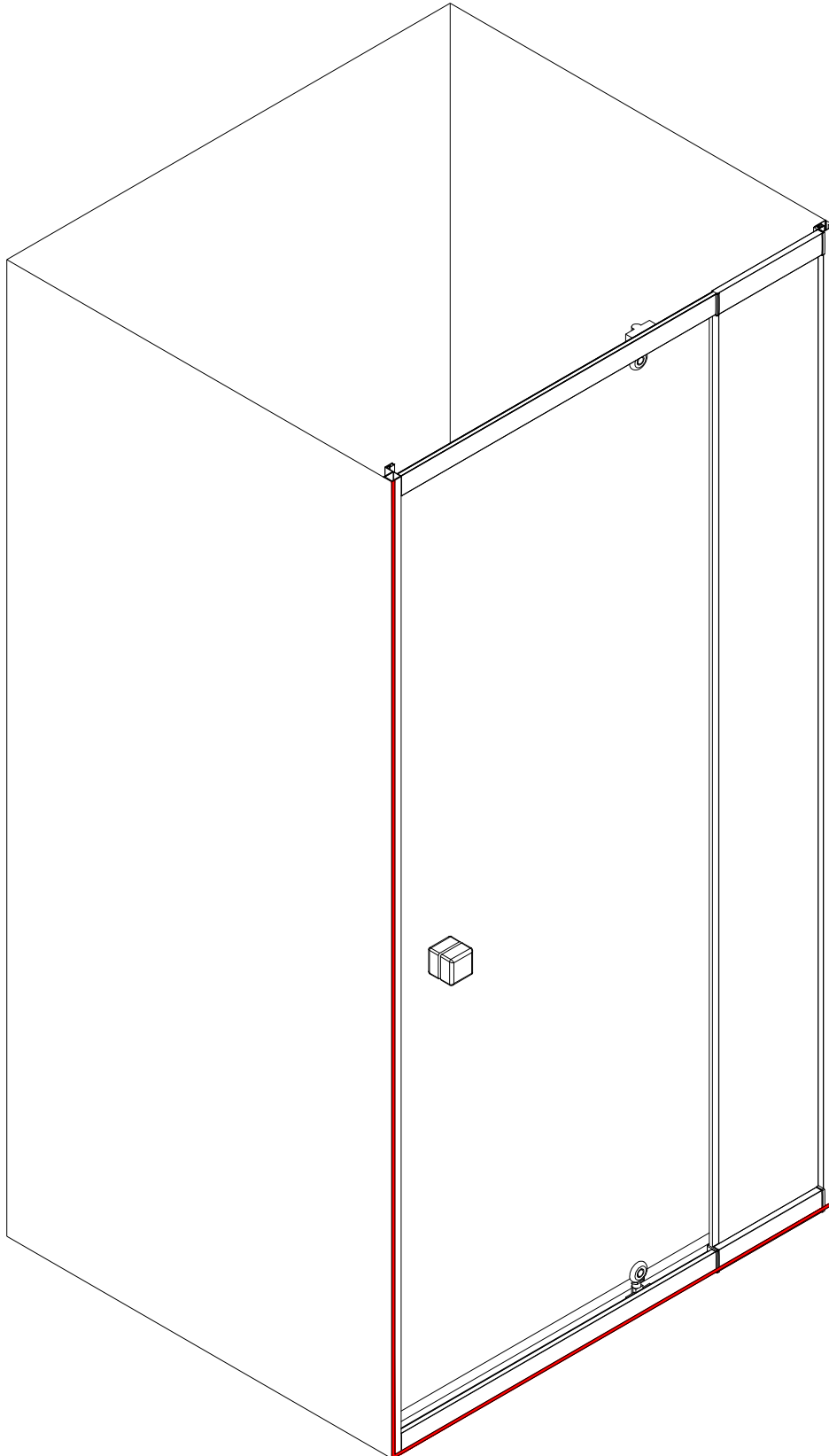
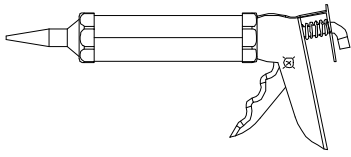

# DÉCLARATION DES PERFORMANCES

N o DoP\_FAC\_033

**1. Code d'identification du produit Type : SPOT**

Par extension, la présente déclaration des performances est applicable aux produits détaillés en annexe.

**2. Usage(s) prévu(s) :** ..... PAROIS DE DOUCHE POUR HYGIENE PERSONNEL-PH.....

**3. Fabricant :** .....AURLANE 32 rue Washington 75008 PARIS.....

**4. Mandataire :** .....Non applicable.....

**5. Système(s) d'évaluation et de vérification de la constance des performances:** système 4.....

**6a. Norme harmonisée:** EN14428:2004

Organisme(s) notifié(s) : Non applicable

**6b. Document d'évaluation européen** Non applicable

**Evaluation technique européenne** Non applicable

**Organisme d'évaluation technique** Non applicable

**Organisme(s) notifié(s)** Non applicable

**7. Performances déclarées**

Caractéristiques essentielles	Performances	Spécifications techniques harmonisées
Aptitude au nettoyage	Exigences satisfaites	EN14428:2004+A1:2008 Clause 4.2
Résistance à l'impact / Propriétés d'éclatement	Exigences satisfaites	EN14428:2004+A1:2008 Clause 4.3
Durabilité	Exigences satisfaites	EN14428:2004+A1:2008 Clause 4.4

Les performances du produit identifié ci-dessus sont conformes aux performances déclarées.

Conformément au règlement (UE) n°305/2011, la présente déclaration des performances est établie sous la seule responsabilité du fabricant mentionné ci-dessus.

Signé au nom du fabricant par:

Sébastien Doumenc  
Directeur associé Aurlane  
A paris, le 03/04/2020



ANNEXE 1 références

code_produit	Designation
FAC488	SPOT 70-80 SQUARE
FAC489	SPOT 80-90 SQUARE
FAC490	SPOT 80 ROUND
FAC491	SPOT 90 ROUND
FAC492	SPOT 80 SLIDING 3 DOORS
FAC493	SPOT 100 SLIDING
FAC494	SPOT 120 SLIDING
FAC495	SPOT PIVOTANTE 70
FAC496	SPOT PIVOTANTE 80
FAC497	SPOT PIVOTANTE 90
FAC498	SPOT SIDE 80
FAC605	SPOT SIDE 90

ANNEXE 2 marquage CE

