

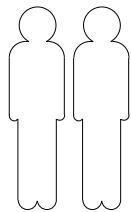

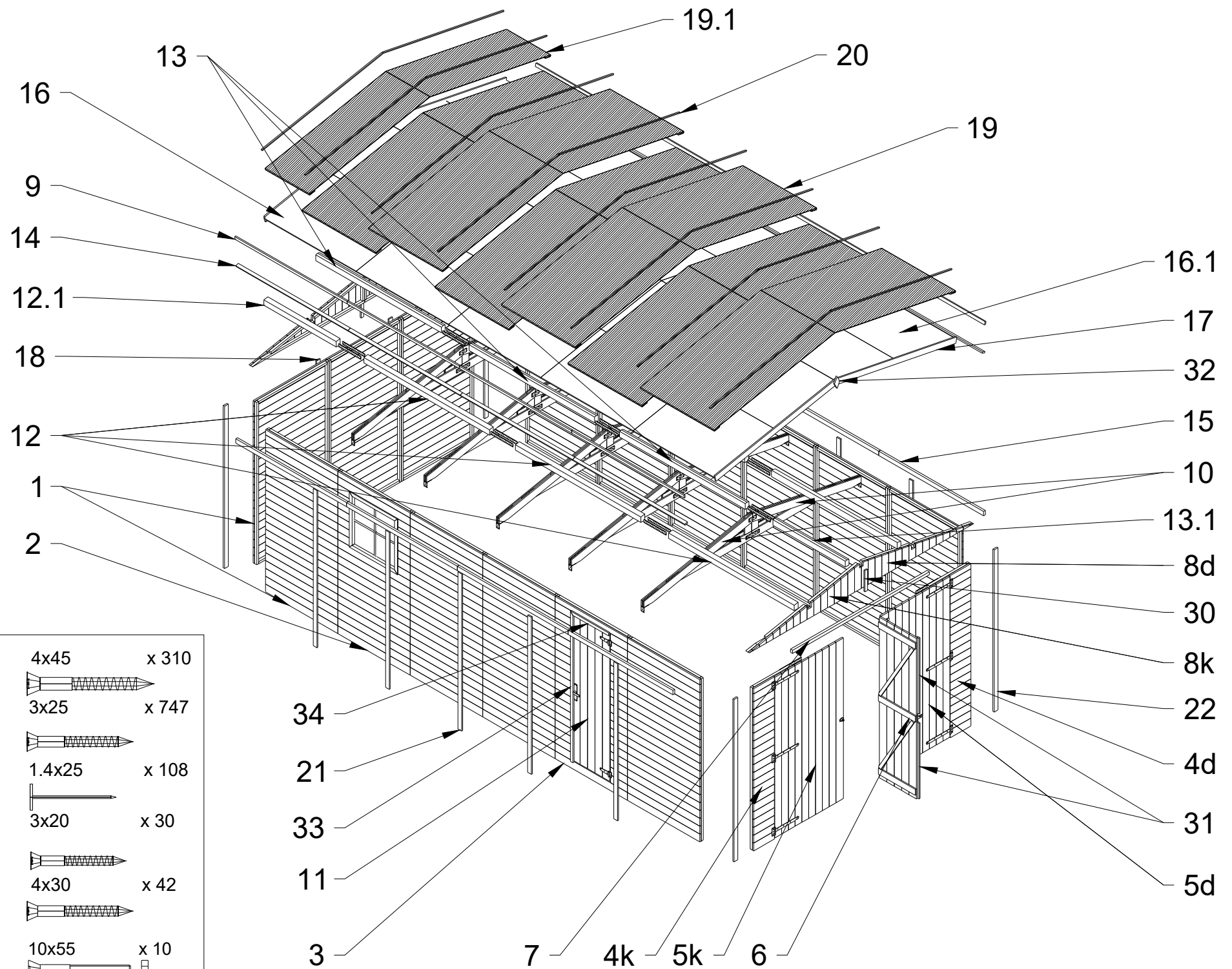















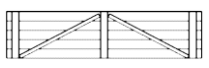
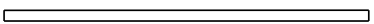

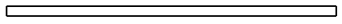
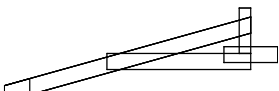

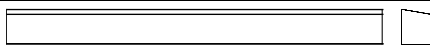
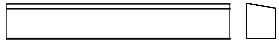
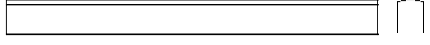
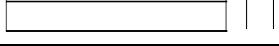
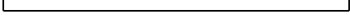
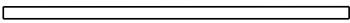



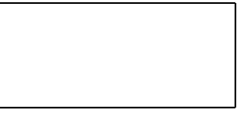

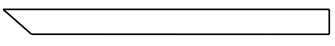
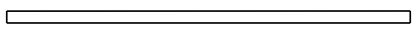

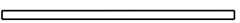
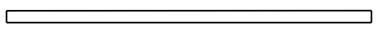
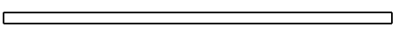
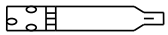
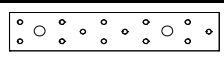
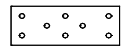
M102

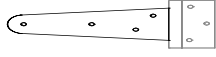
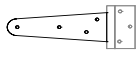

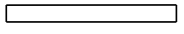
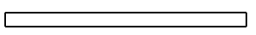
№		PCS			
			mm	mm	mm
1		12		980	1900
2		2		980	1900
3		1		980	1900
4k		1		280	1900
4d		1		280	1900
5k		1		930	1880
5d		1		930	1880
6		1		500	1880
7		1	30	60	1850
8k		2		300	1517
8d		2		300	1517
9		8	15	35	1520
10		10		363	1470
11		1		590	1690
12		6	40	60	1700
12.1		2	40	60	1000
13		3	40	60	1700
13.1		1	40	60	1000
14		10	OSB	35	1220
15		8	17	47	1520

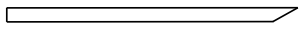
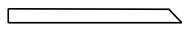
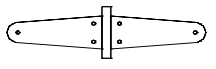
№		PCS			
			mm	mm	mm
16		16	OSB	830	1250
16.1		4	OSB	830	1100
17		4	15	69	1700
18		2	15	35	1900
19		6		1 m	3,470m
19.1		1		0,5	3,470m
20		32	15	35	813
21		10	15	35	1835
22		4	17	47	1900
23		1			
24		28			
25		10			
26		17			
27		6			
28		2			
29		2			
30		2	15	35	245
31		2	15	35	920
32		2	15	75	145
33		1	15	35	1705
34		1	15	35	605
35		3			
36		2			

1

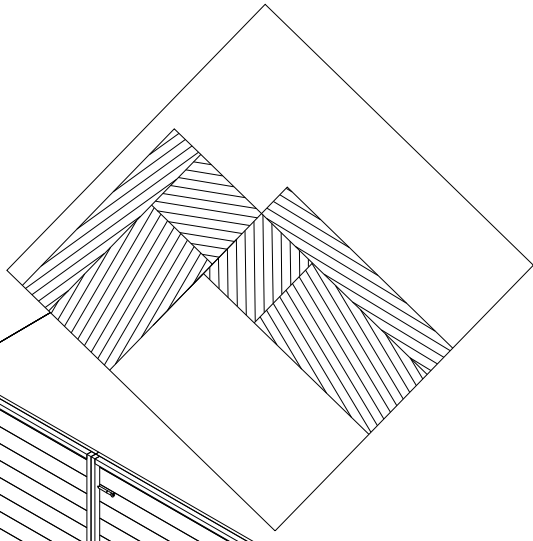
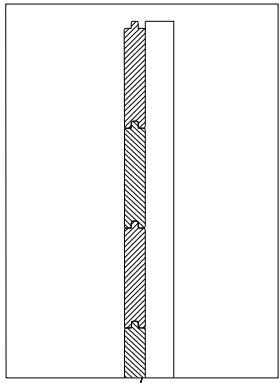

2

3

A_{x27}

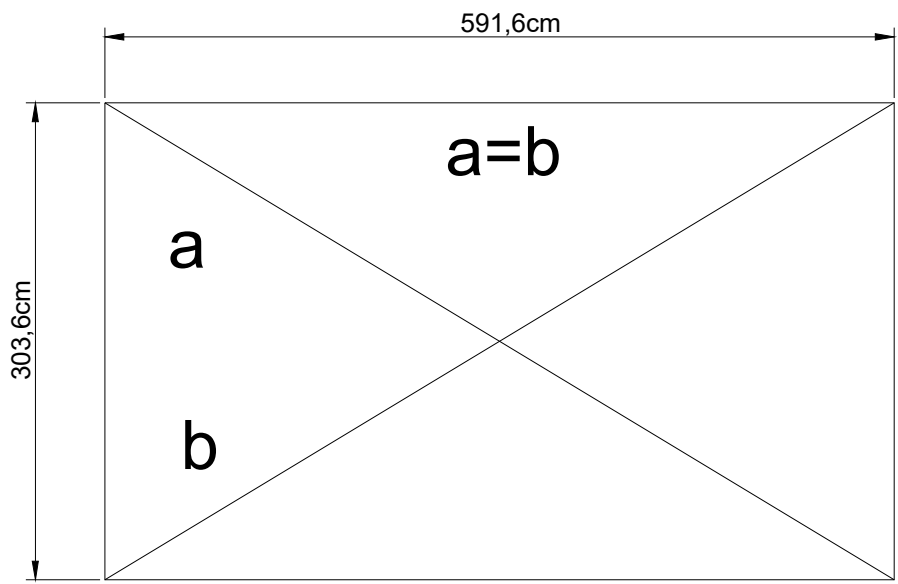

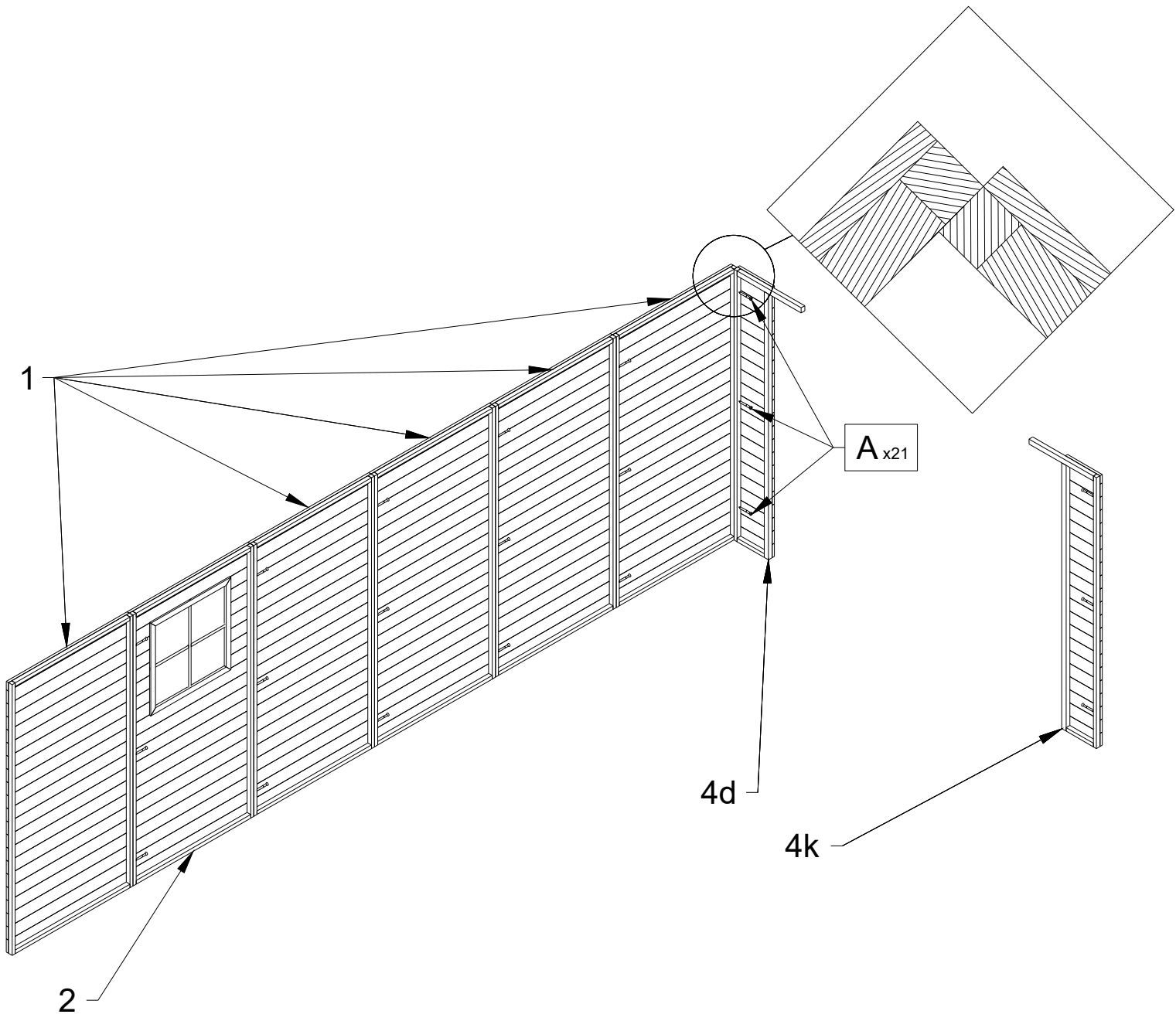

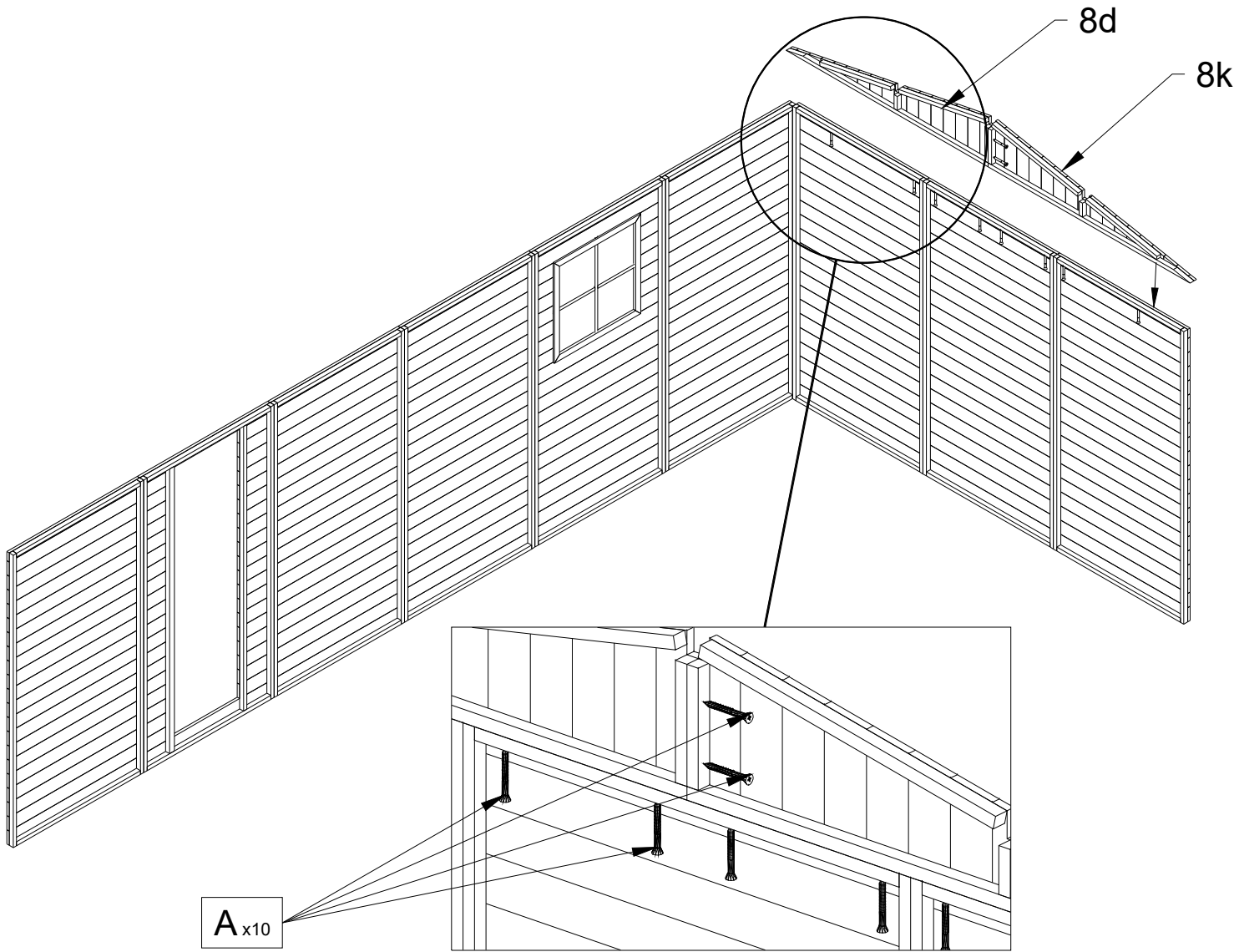

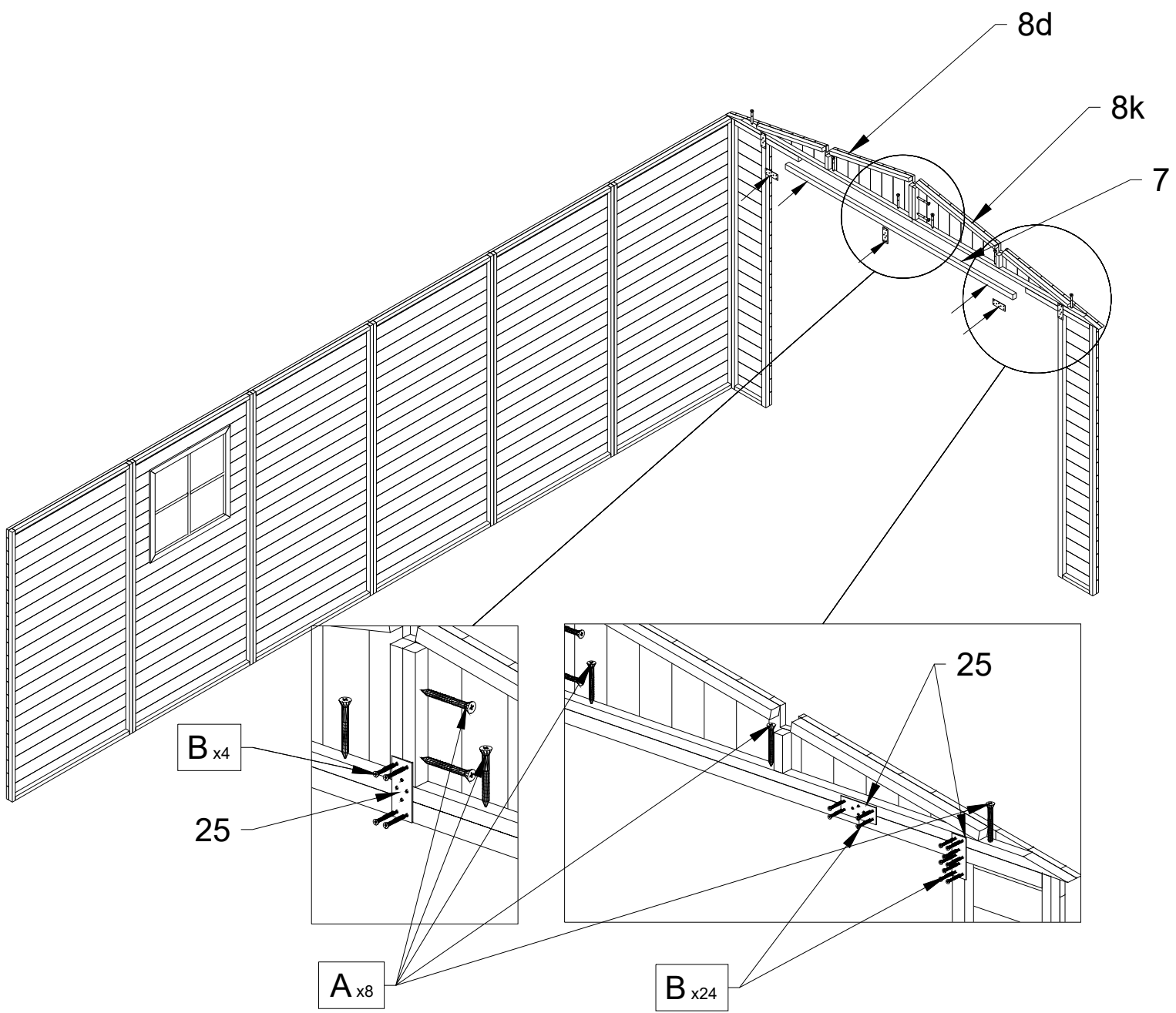

5

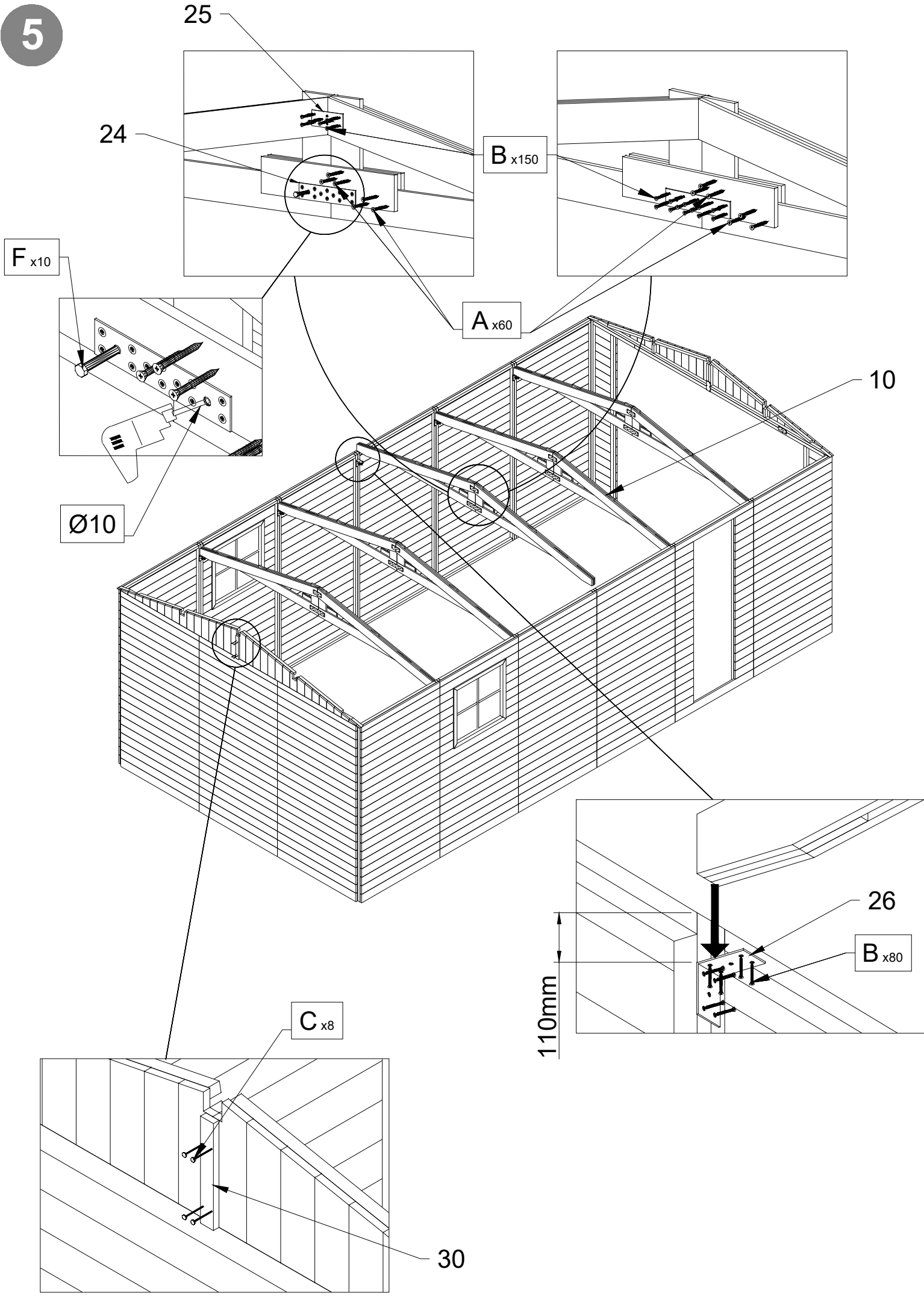

6

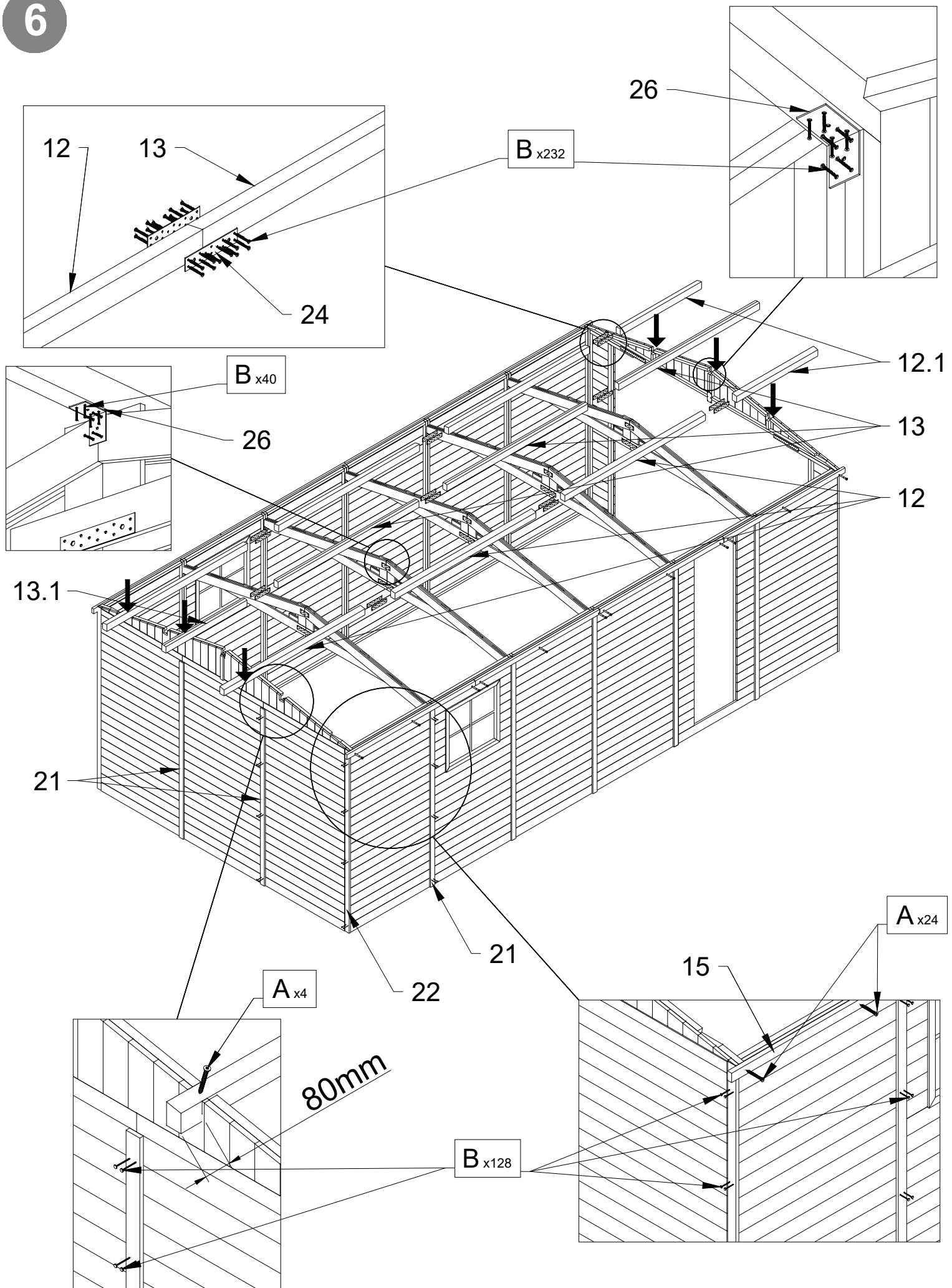

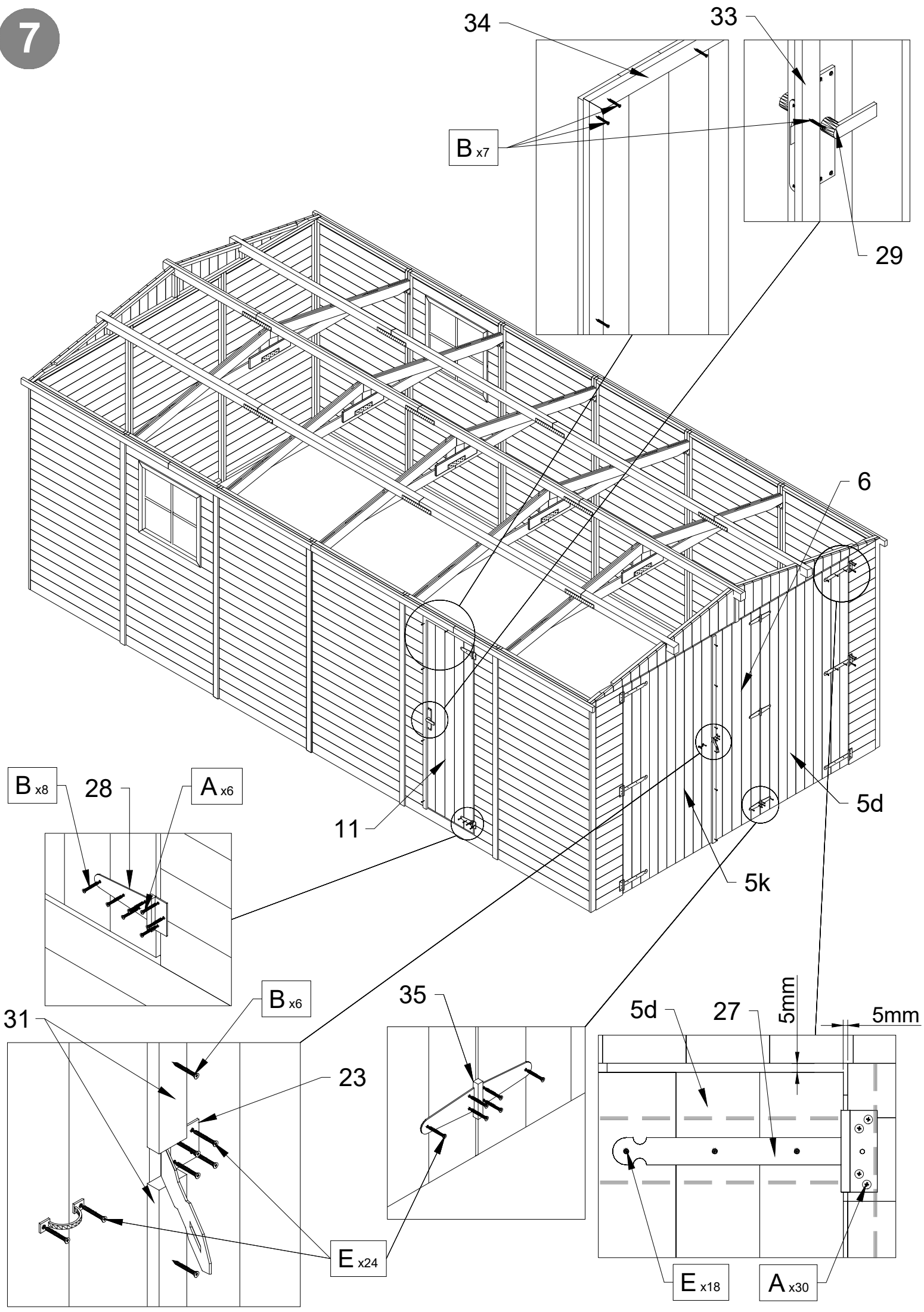

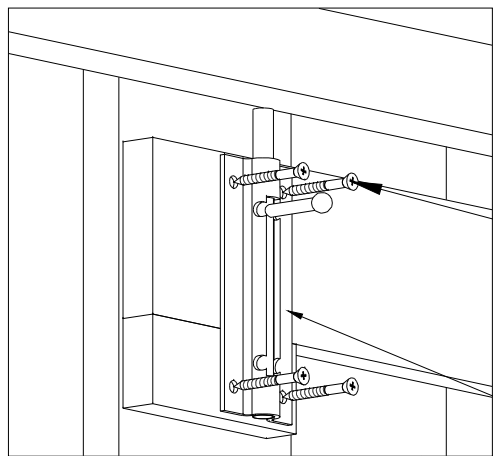

Int.

Ø12

B x12

36

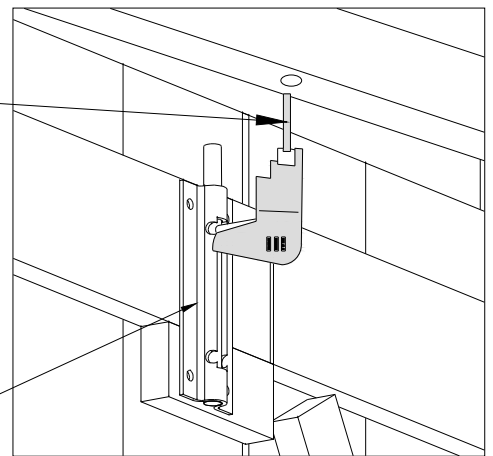

Int.

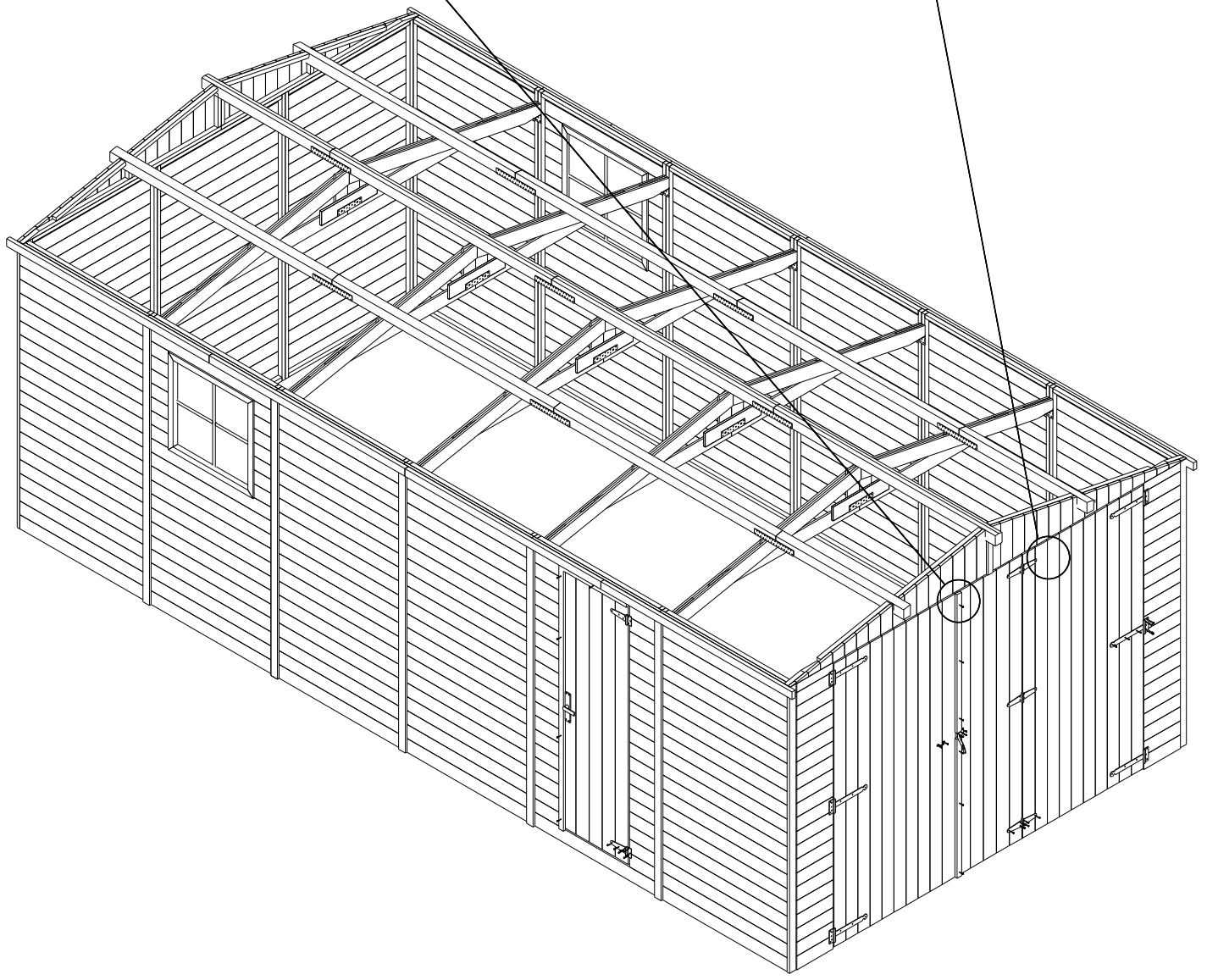

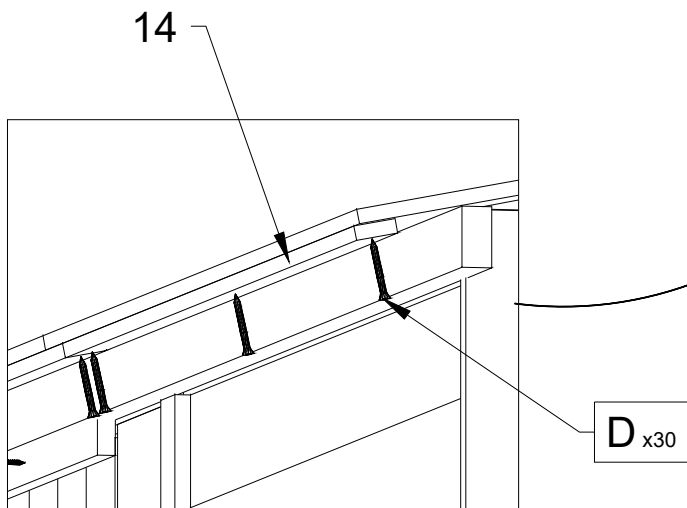
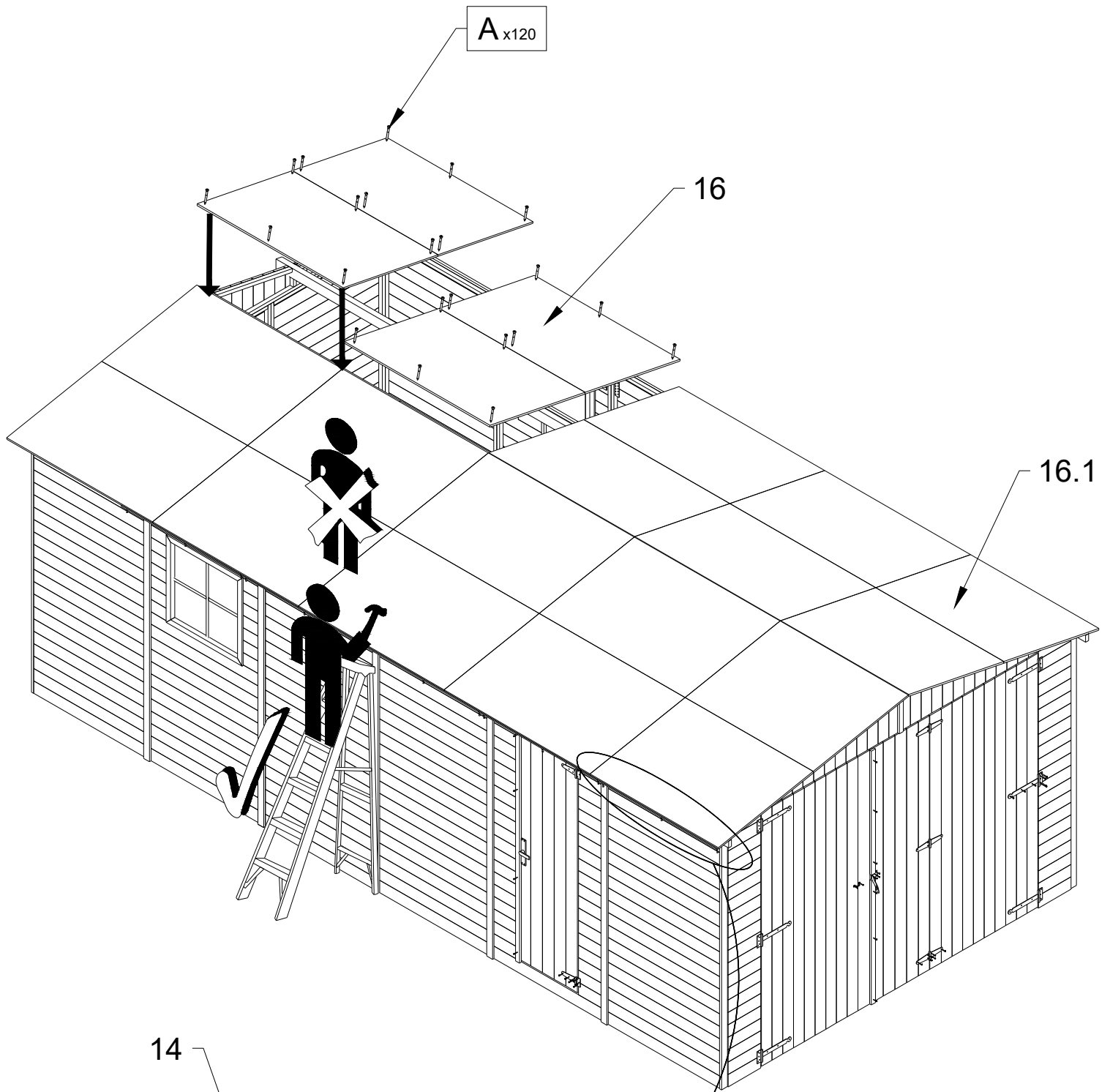

C x96

19.1

19

20

MAX
30 kg/m²

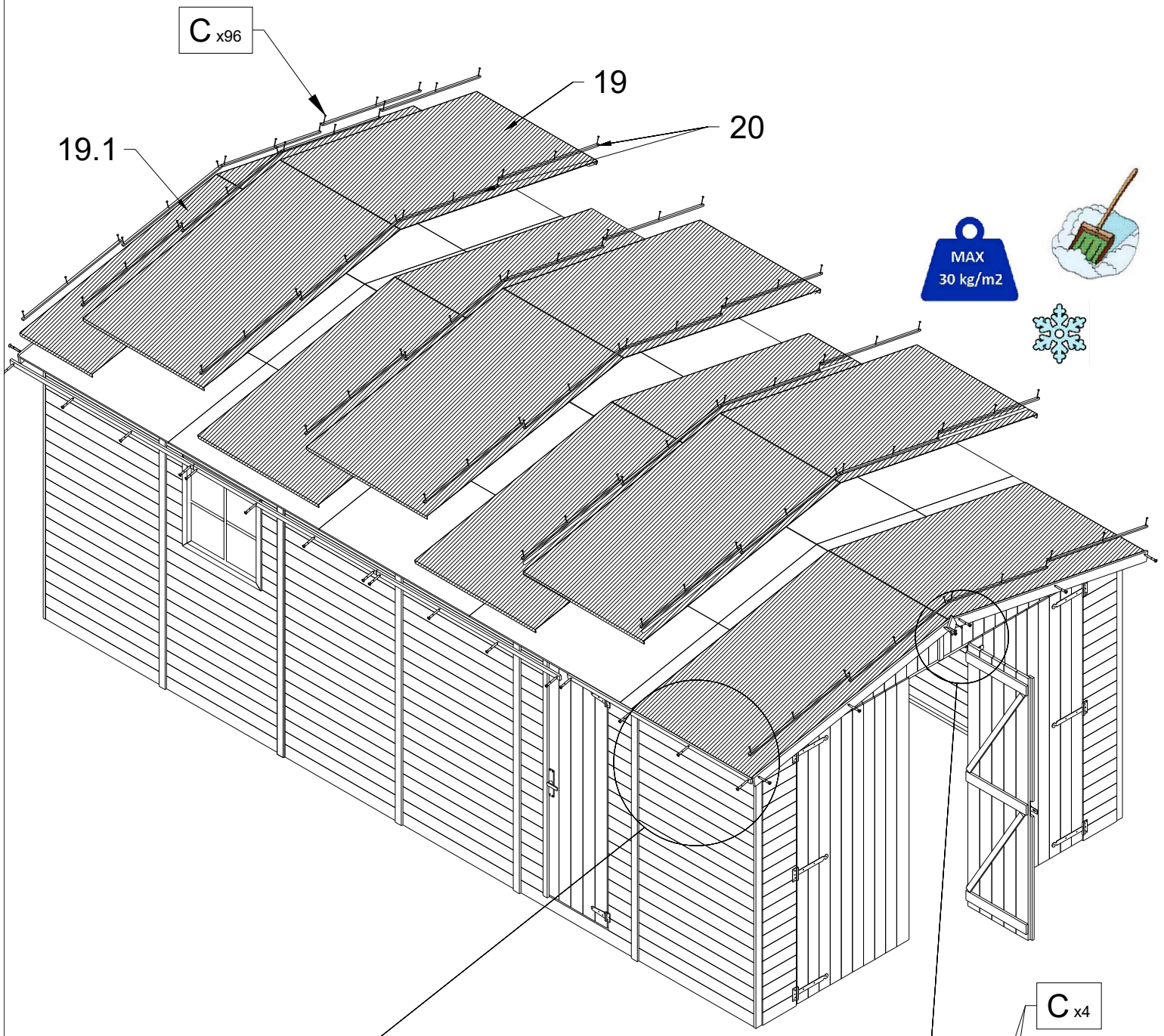

C x4

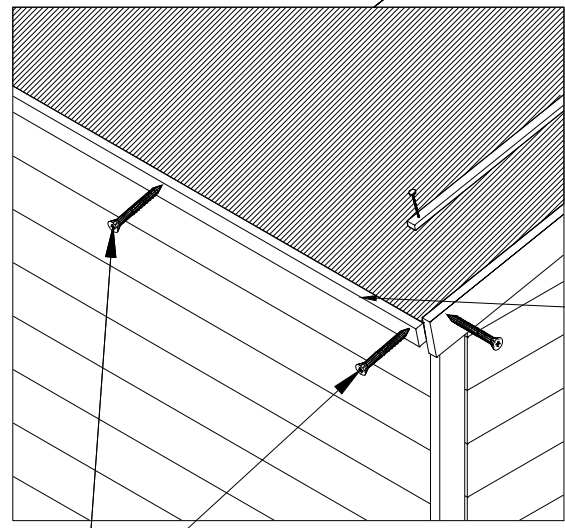

B x32

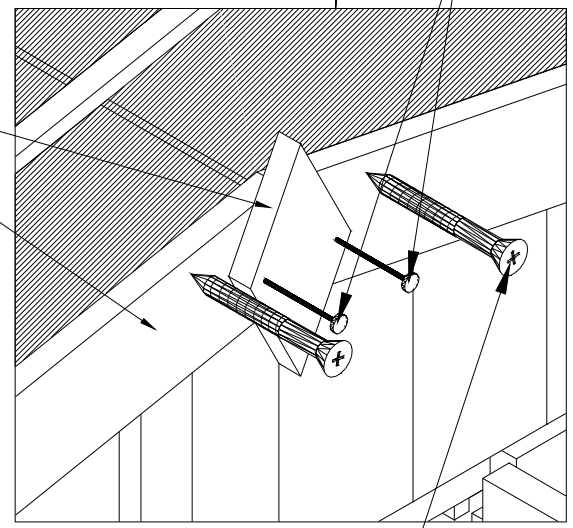

B x12

32

17

9