

UNIFIX

100WP / 145WP

FR



Support nautisme portique

UNIFIX 100WP / 145WP

Cher client, nous vous remercions de votre achat pour l'un de nos produits Uniteck. Veuillez prendre connaissance avec attention de toutes les instructions avant d'utiliser votre produit.

Les supports Unifix 100WP et 145WP ont été spécialement conçus pour fixer vos panneaux photovoltaïques Unisun 100.12M ou 145.12M sur votre bateau.

Il s'installe sur tous les portiques de diamètre 28 à 40 mm et dont la distance entre les barres n'excède pas 450 mm.

Grâce à sa structure et sa visserie en inox marine, il est parfaitement adapté pour un usage en milieu salin.

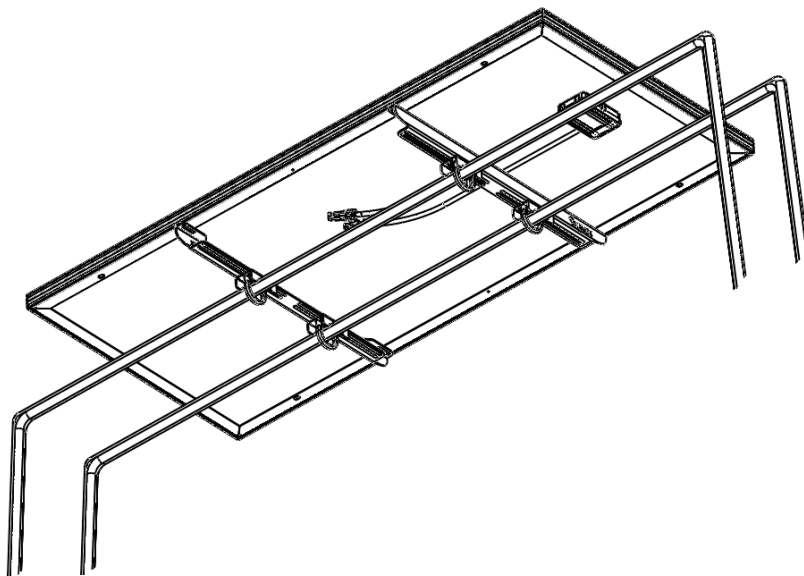

Pour réaliser la connexion panneau/régulateur/batterie, nous vous recommandons d'utiliser les kits prêts à l'emploi Uniconnect qui optimisent vos performances électriques et simplifient le montage.





CONSIGNES DE SÉCURITÉ

- Prenez les mesures appropriées pour prévenir les accidents pendant vos travaux de montage.
- Si le panneau et le support sont exposés aux rayons du soleil pendant une longue période, il y a un risque de brûlure. Protégez-vous.
- A la fin des travaux, vérifiez que vos supports et panneaux soient bien fixés.





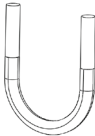
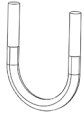
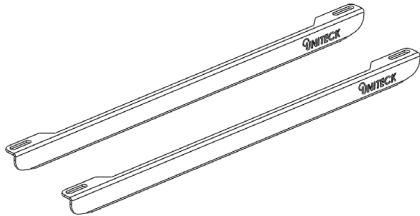
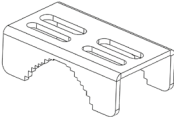

RECOMMANDATIONS

- Montez les supports Unifix uniquement sur des portiques présentant une portance suffisante. Tenez compte de la charge supplémentaire avec panneau :
 - Installation 200W : 2 x (Unifix 100WP (2,2 kg) + Unisun 100.12M (8 kg)) : 20,4 kg
 - Installation 145W : Unifix 145WP (2,8 kg) + Unisun 145.12M (11,5kg) : 14,3 kg
 - Installation 290W : 2 x (Unifix 145WP (2,8 kg) + Unisun 145.12M (11,5 kg)) : 28,3 kg
- Les supports Unifix sont exclusivement destinés à la fixation de panneaux Unisun.

Liste des pièces - Version Mono Barre (production à partir de 01/09/2015)

						
M8x20 X4	D8 x12	D6 X8	M8 X12	M6 X8	M8x74x52x35 X4	M6x53x34x25 X4
						
N°1 X2					N°2 X4	

Liste des pièces - Version Multi Barre (production jusqu' au 01/09/2015)

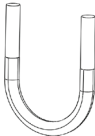
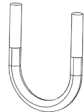
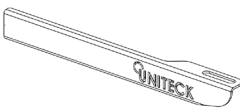
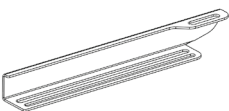
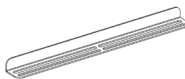
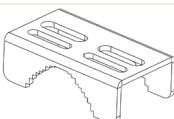

							
M8x20 X4	M6x16 X8	D8 X12	D6 X16	M8 X12	M6 X16	M8x74x52x35 X4	M6x53x34x25 X4
							
N°3 X2		N°4 X2		N°5 X2		N°2 x4	

Couple de serrage préconisé

Vis	Couple
M5	5,10 Nm
M 6	8,80 Nm
M 8	21,50 Nm
M 10	44,00 Nm

Nb. Coefficient de frottement moyen $\mu=0,20$ / Serrage à 50% de la limite élastique

- Prémontez le support (Version Multi Barre UNIQUEMENT).

	M6x16 X8		N°3 X2
	D6 X16		N°4 X2
	M6 X8		N°5 X2

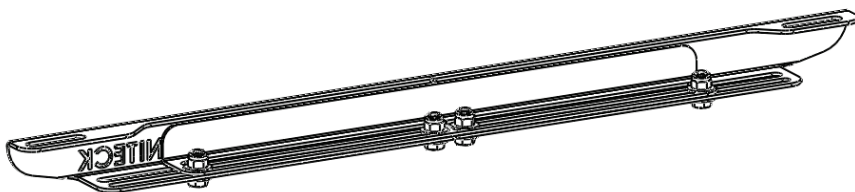
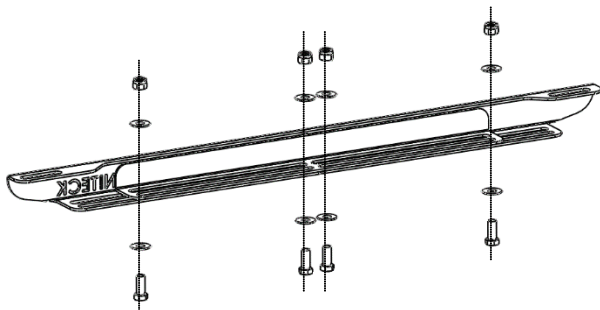
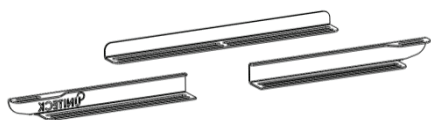

- Pré-sérrez les écrous. Le serrage définitif sera réalisé après avoir fixé le panneau solaire.

- Positionnez les 2 supports sur les panneaux solaires.

	M8x20 X4
	D8 X4
	M8 X4

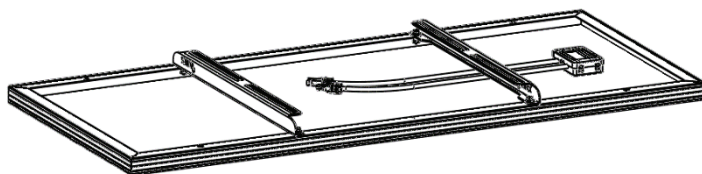
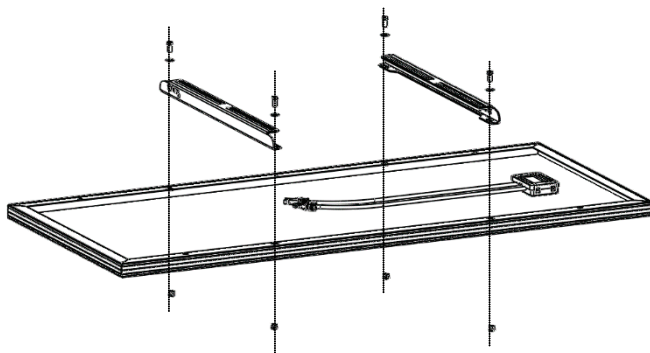

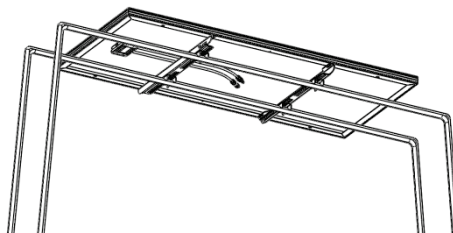
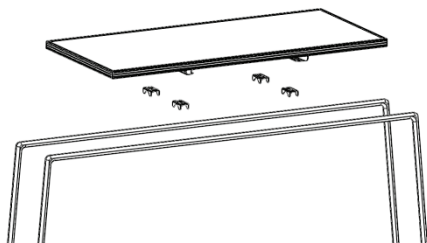
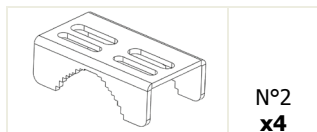

- Positionnez les panneaux solaires sur votre portique ainsi que les 4 étriers.



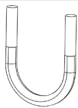

- Fixez l'ensemble grâce aux cadènes fournies.

Tubes du portique entre 25 et 30 mm

	M6x53x34x25 X4
	D6 X8
	M6 X8

Tubes du portique entre 30 et 40 mm

	M8x74x52x35 X4
	D8 X8
	M8 X8

