

Instruction Manual

Electric Patio Heater

ZHQ1821SH-MI

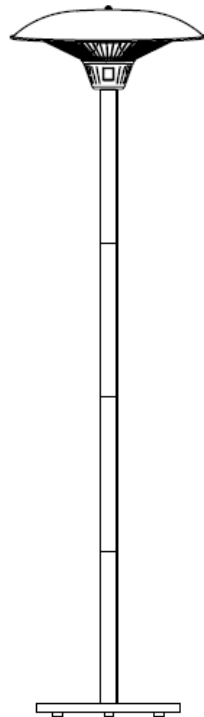

Unpack the halogen heater making sure that all the items are present and that there are no components left in the box and that the heater head is free from any packing material.

Using the detailed drawing follow the steps to assemble your halogen heater.

Do not connect the halogen heater to the electrical supply until all the assembly is complete.

Do not connect the halogen heater to the electrical supply if any of the components or the power cord is damaged in any way.

If in doubt contact your supplier.

Please read these instructions carefully before using your new halogen heater

Assembling Process

Step 1: Connect the bottom tube with base by screwing them together.

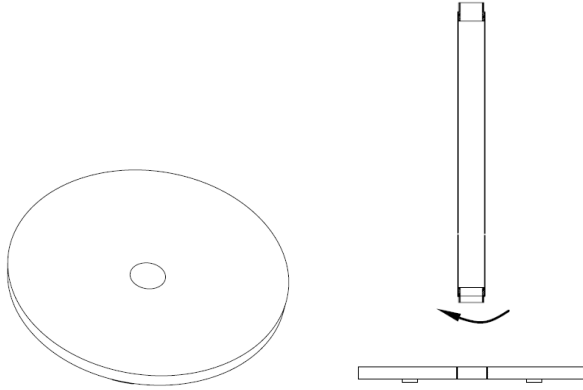

Step 2: Feed the Power Cord through the Base and the Bottom Tube, and pull through around 1.8m of cable.

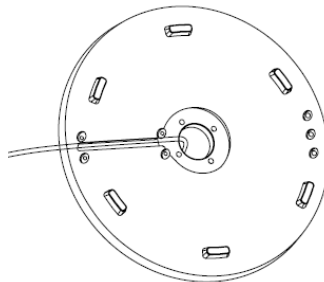

Step 3: Connect two middle tubes with bottom tube by screwing them together.

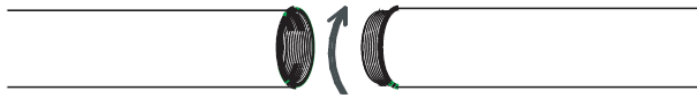

Step 4: Connect the top tube with middle tube by screwing them together.

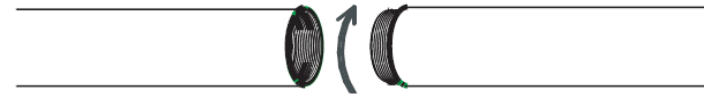

Step 5: Place the power cord plug through base, bottom pole, middle pole and top pole. Connect the power cord plug to the socket in the heater head.

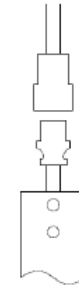

Step 6: Push the Heater Head onto the Top Tube and fix in position using the 4x8mm screws.

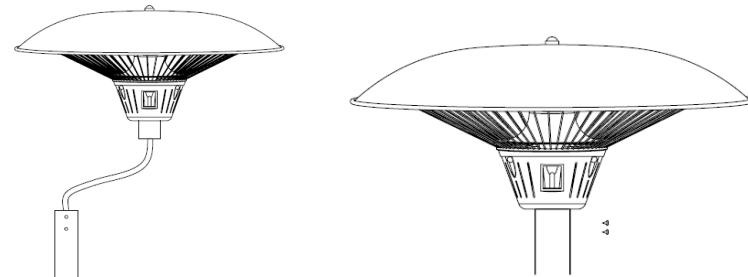

Step 7: Fix the power cord on the base by using Four M4 nuts.

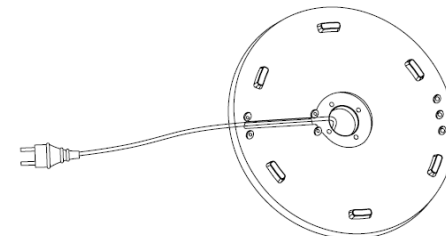

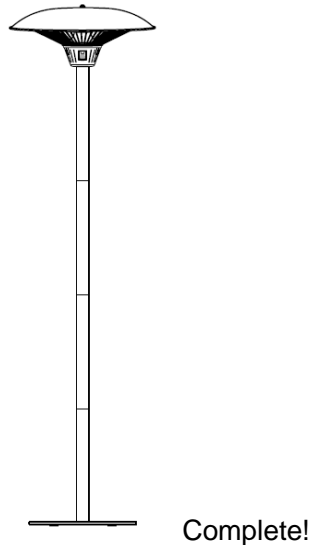

Caution

Only use the halogen heater on a firm solid horizontal area where all the feet on the base are in contact with the floor. (Should the heater be tilted or fall over the auto cut off switch will activate)

1. **S**ite the heater outside or in a large open area and well away from any obstructions such as branches or where the heater is near any objects that can be affected by heat, such as furniture, curtains or other inflammable objects (minimum distance 1 meter).
2. **D**o not use near bath tubs, wash areas or swimming pools.
3. **D**o not use in unventilated areas
4. **D**o not use where gas, petrol, paint or other inflammable goods are stored.
5. **D**o not push any items through, obstruct or cover the grill of

the heater head.

6. **D**o not position immediately above or below an electrical socket.
7. **D**o not move when connected to an electrical supply and always wait for the patio heater to cool down before storing away.
8. **D**o not touch the heater head when in use.
9. **D**o not leave turned on and unattended especially when children and or animals are in the vicinity.
10. **T**he indication of the different positions of switches shall be visible from a distance of 1M.
11. **T**he Marking concerning covering shall be visible after the heater has been installed. **I**t shall not be placed on the back of portable heaters.
12. **T**he unit must be placed with the clearance of 100cm to the wall and 30cm to the ceiling.
13. **T**he unit must be correctly installed according to the instructions. Make sure the head is at least 1.8m from the floor.
14. **T**he unit must be securely placed on a horizontal and flat surface.
15. **T**he unit is at high temperature during operation. It keeps hot

- for a period after shut down. **P**otential danger would occur when touching it during this period.
16. **D**on't place the unit closed to curtain and/or other flammable objects. **O**therwise there will be a danger of catching fire.
 17. **D**on't cover the unit with anything during operation or a short time after it's shut down.
 18. **D**on't wrap the power supply cord on the unit.
 19. **T**he unit must be handled with care, and avoid vibration or hitting.
 20. **T**he unit must be securely grounded during operation.
 21. **I**f the unit gets damaged, it must be repaired by professional electricians.
 22. **W**hen the power supply cord is damaged, it must be replaced by authorized agent or other professional people to avoid danger.
 23. **T**he unit must not be positioned under a socket.
 24. **W**hen assembling, keep clear from any board or flammable material.
 25. **T**he unit must be supervised by adults if it's used by a child.
 26. **I**t is not safe to install the unit by a swimming pool, in a bathroom or shower area.
 27. **T**he unit is for household use only. It is not safe to use on a building site, greenhouse, barn or stable where there's flammable dust.
 28. **T**he head of the unit is at high temperature during operation.
Unplug the unit and wait till it cools before cleaning.
 29. **D**on't use this unit in place where causticity or volatile air exists, i.e. dust, steam, gas, etc.
 30. **D**on't use this unit as a cloth drier or towel drier.
 31. **D**on't use this unit as a sauna heater.
 32. **D**on't use this unit in place of animal propagating and raising.
 33. **D**on't immerse this unit into water for cleaning.
 34. **T**he unit should be plugged in a socket, which is easily visible and reachable.
 35. **T**wo Dark points may exist on the surface of the heating elements during the first few minutes after it is turned on. **T**his is normal, and will not affect the performance of the unit.
 36. **A** tilt switch is fitted inside the unit for safety purpose.
 37. **T**he Wheels are only for the purpose of moving the Heater,

once the Heater is in the right position, the wheels should be removed for safety purpose.

WARNING: This heater is not equipped with a device to control the room temperature. Do not use this heater in small rooms when they are occupied by persons not capable of leaving the room on their own, unless constant supervision is provided.

The heater is to be installed so that switches and other controls cannot be touched by a person in the bath or shower.

Operation

Connect the power cable to a 13 amp supply that is located in a safe, dry area.

- The switch on the heater head is used to control the heat setting. (I) for 2100w. The 0 position is off.
- Although the patio heater is shower proof, do not use when raining or in wet conditions.
- Always disconnect the power cable from the electrical supply, when the patio heater is not in use.

Care and maintenance

- When disconnected from the electrical supply, clean the outside of the patio heater with a damp cloth. Never use corrosive or solvent cleaners or immerse in water.
- Any maintenance or repairs including replacing the halogen tube should only be carried out by a qualified electrician or by a recommended service center.

Technical specification

- Power supply 220-240V 50Hz
- Wattage max 2100W
- Net weight 10.1kg
- Insulation class I
- Height 205 cm