

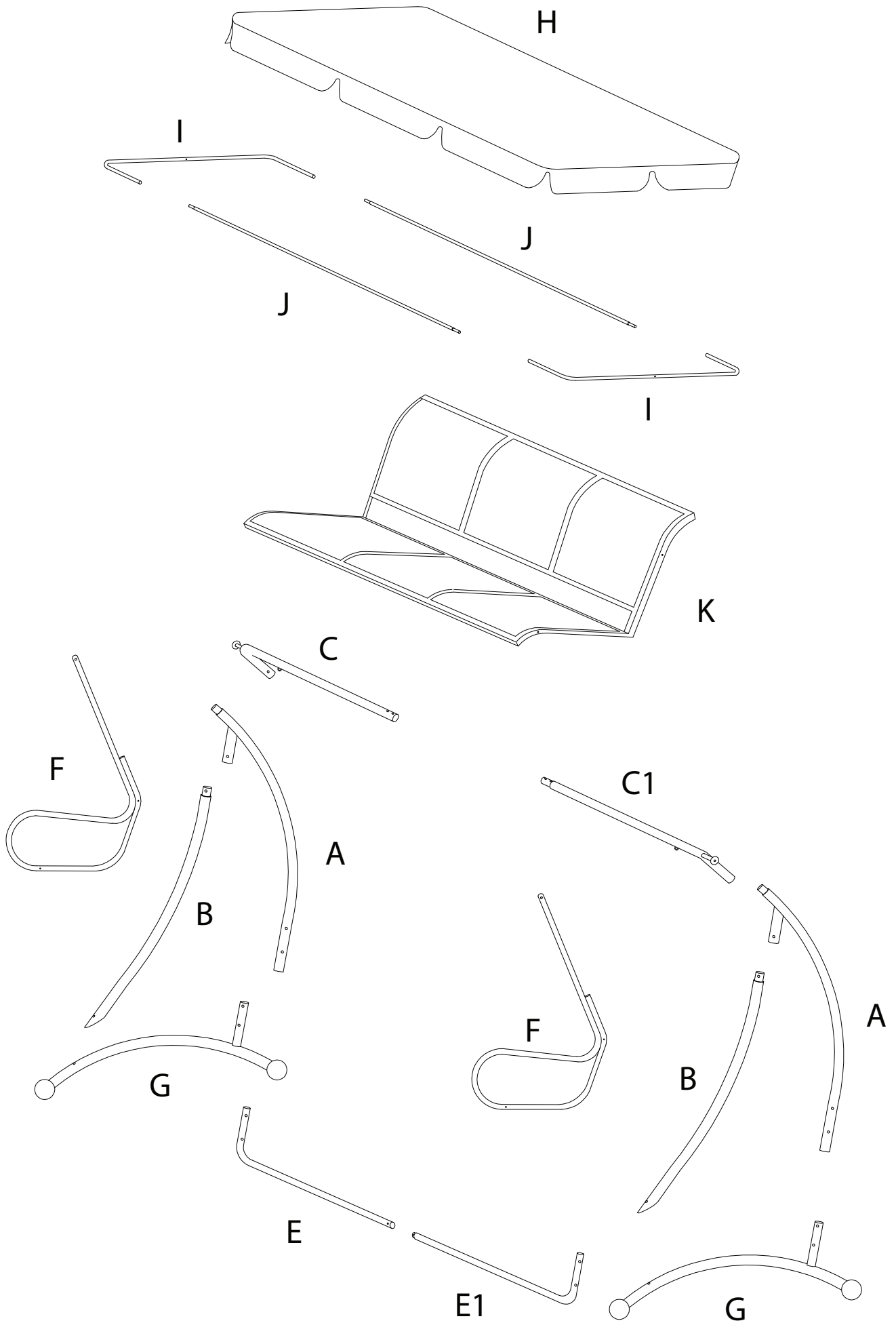







Assembly instructions for step 1/10:

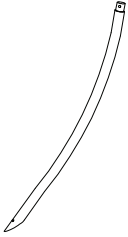
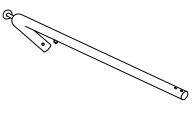
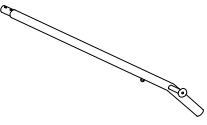
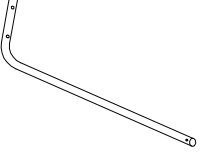
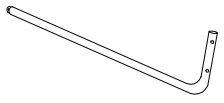
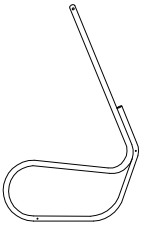
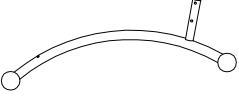
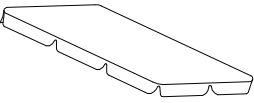

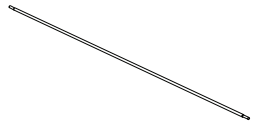
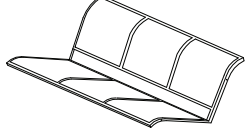
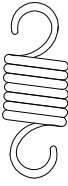
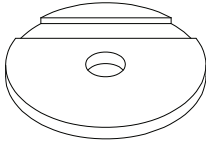
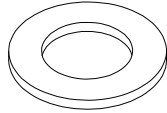
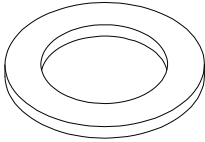
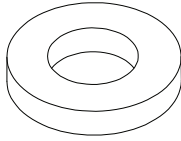
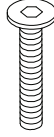
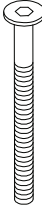
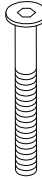
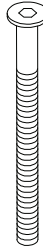
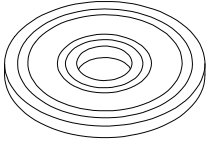
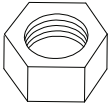
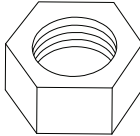
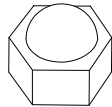
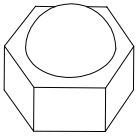

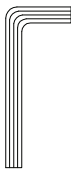
- Tools: An icon in a circle shows an Allen key and a wrench. A power drill is shown with a diagonal line through it, indicating it should not be used.
- Warning: A triangle with an exclamation mark indicates a warning.
- Time: A clock icon indicates a 90-minute assembly time.
- Personnel: An icon of a person and the number '2' indicate that two people are required for assembly.



<p>A</p>  <p>x2</p>	<p>B</p>  <p>x2</p>	<p>C</p>  <p>x1</p>	<p>C1</p>  <p>x1</p>
<p>E</p>  <p>x1</p>	<p>E1</p>  <p>x1</p>	<p>F</p>  <p>x2</p>	<p>G</p>  <p>x2</p>
<p>H</p>  <p>x1</p>	<p>I</p>  <p>x2</p>	<p>J</p>  <p>x2</p>	<p>K</p>  <p>x1</p>



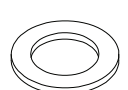
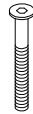
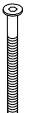
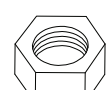
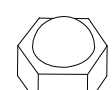

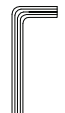

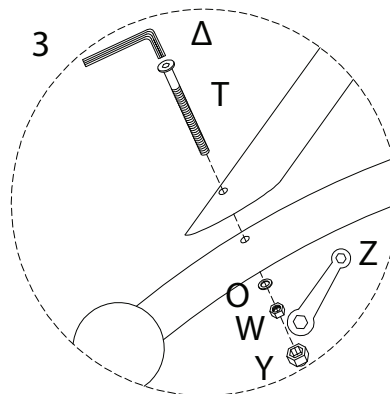
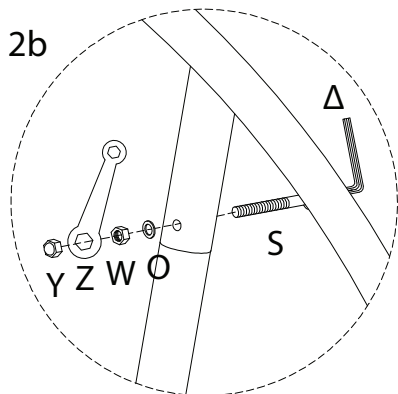
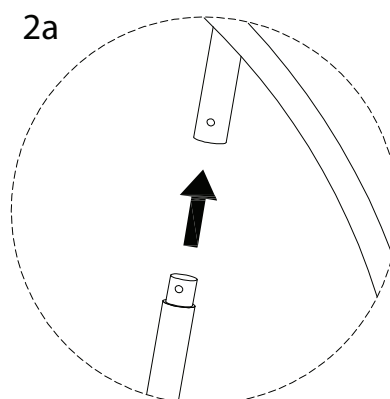
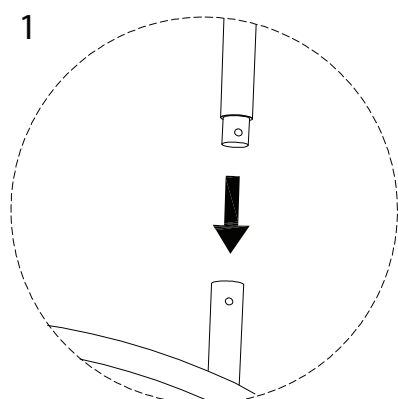
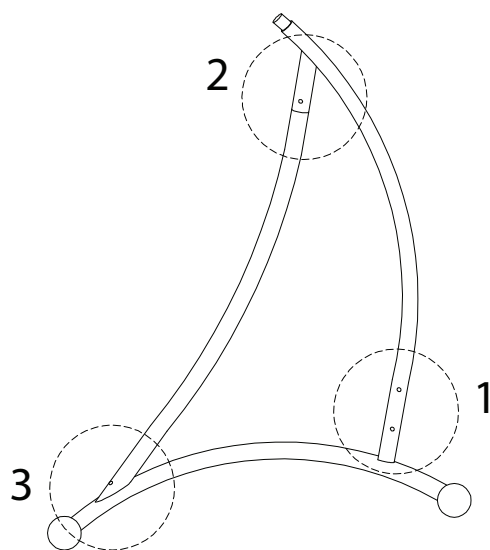
<p>L</p>  <p>x 2</p>	<p>M</p>  <p>x 4</p>	<p>N</p>  <p>x 5</p>	
<p>O</p>  <p>x 12</p>	<p>P</p>  <p>x 4</p>	<p>Q</p>  <p>M6 x 32</p> <p>x 1</p>	
<p>R</p>  <p>M6 x 78</p> <p>x 4</p>	<p>S</p>  <p>M8 x 58</p> <p>x 8</p>	<p>T</p>  <p>M8 x 80</p> <p>x 6</p>	
<p>U</p>  <p>x 2</p>	<p>V</p>  <p>x 5</p>	<p>W</p>  <p>x 12</p>	<p>X</p>  <p>x 5</p>
<p>Y</p>  <p>x 12</p>	<p>Z</p>  <p>x 1</p>	<p>Г</p>  <p>x 1</p>	<p>Δ</p>  <p>x 1</p>

1 x 2

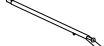
<b>A</b>  x 1	<b>B</b>  x 1	<b>G</b>  x 1	<b>O</b>  x 2	<b>S</b>  M8 x 58 x 1
<b>T</b>  M8 x 80 x 1	<b>W</b>  x 2	<b>Y</b>  x 2	<b>Z</b>  x 1	<b>Δ</b>  x 1

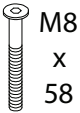



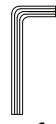

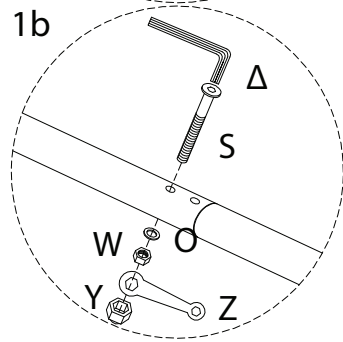
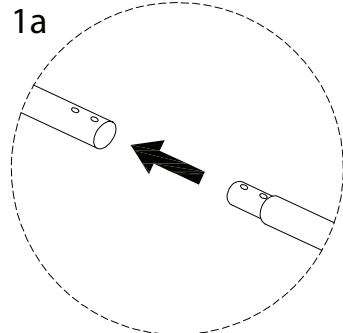
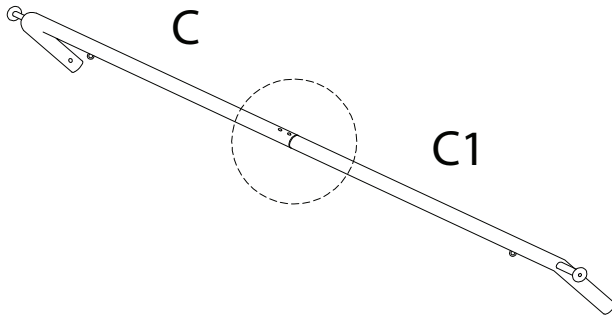

2

C	C1	O	S M8 x 58	W	Y	Z	Δ
							
x1	x1	x2	x2	x2	x2	x1	x1



3

O	S M8 x 58	W	Y	Z	Δ
					
x2	x2	x2	x2	x1	x1

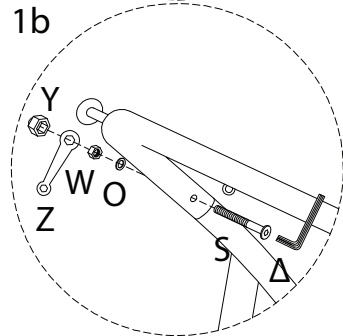
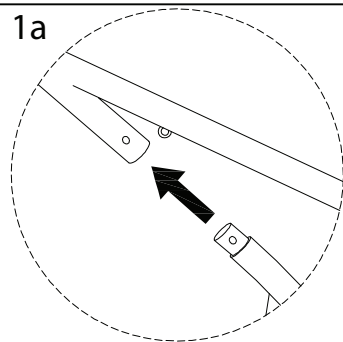
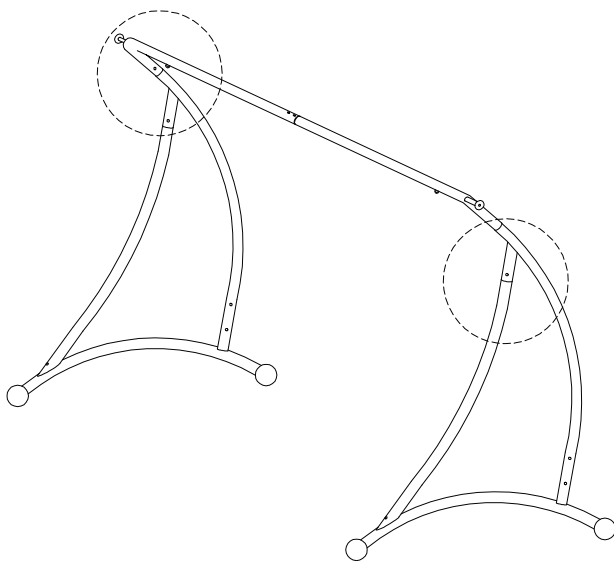

4

E	E1	N	Q M6 x 32	V	X	Z	Г
x1	x1	x1	x1	x1	x1	x1	x1

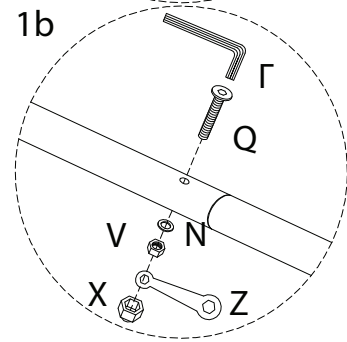
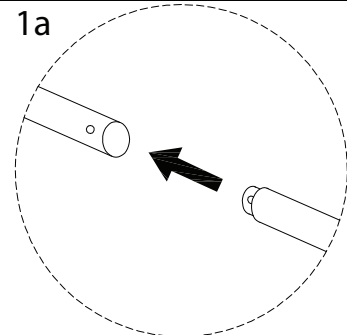
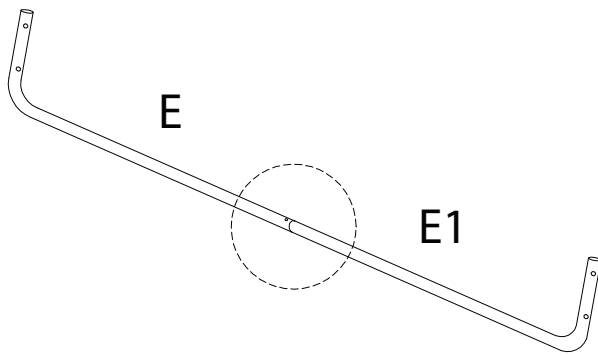



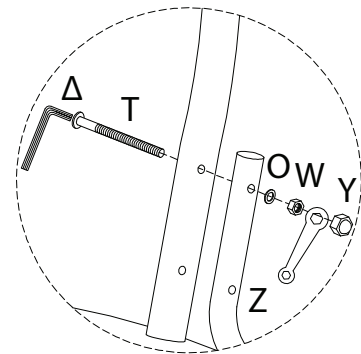
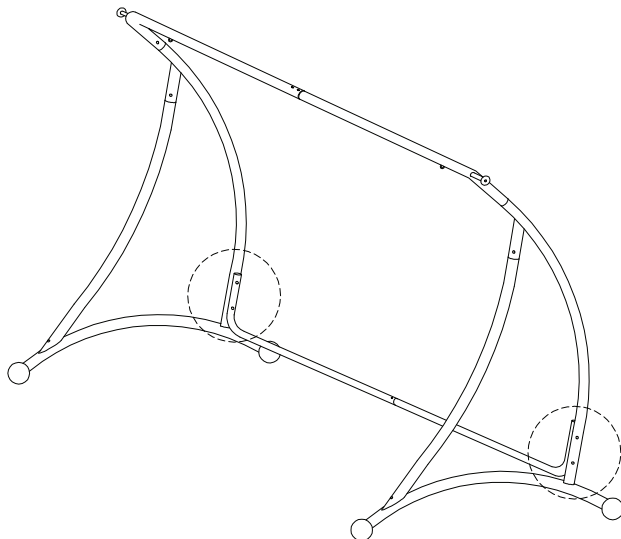

5

O	T M8 x 80	W	Y	Z	Δ
x4	x4	x4	x4	x1	x1

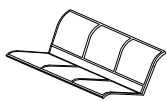
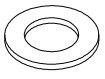
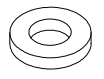

6

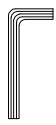
<b>F</b>  x 2	<b>K</b>  x 1	<b>N</b>  x 4	<b>P</b>  x 4	
<b>R</b>  M6 x 78 x 4	<b>V</b>  x 4	<b>X</b>  x 4	<b>Z</b>  x 1	<b>Г</b>  x 1

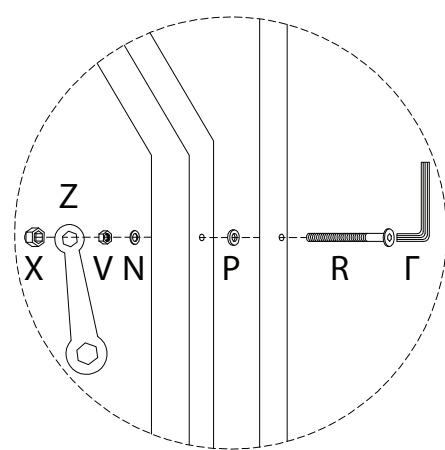
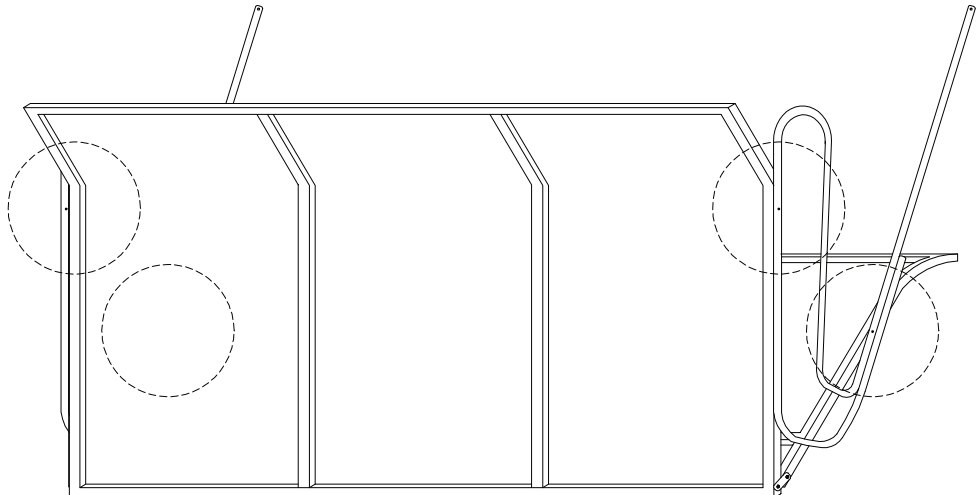



7

L  
  
x 2

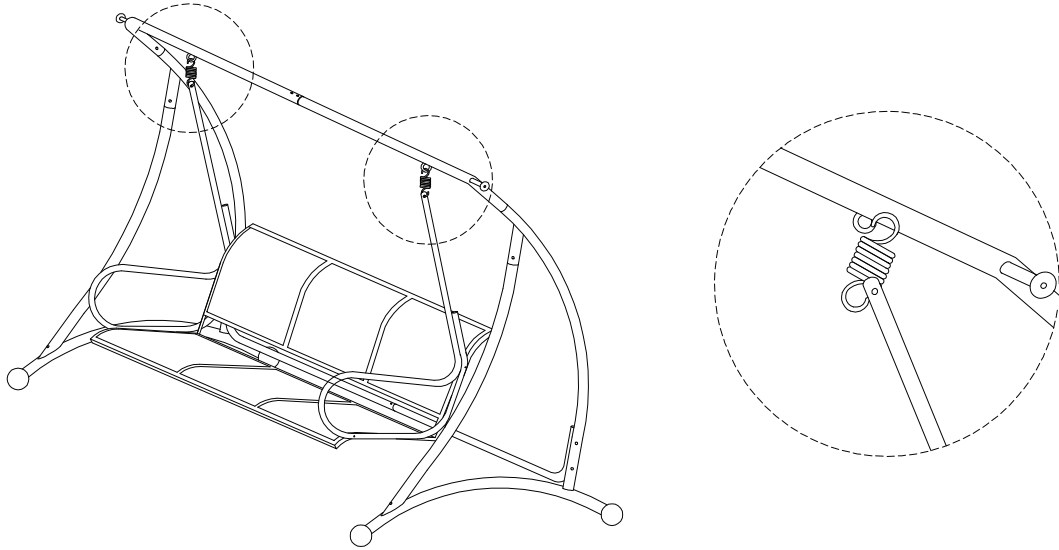

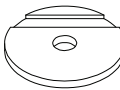

8

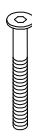
M  
  
x 4

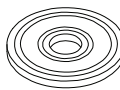
S  
  
M8  
x 58  
x 2

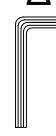
U  
  
x 2

Δ  
  
x 1

I  
  
x 2

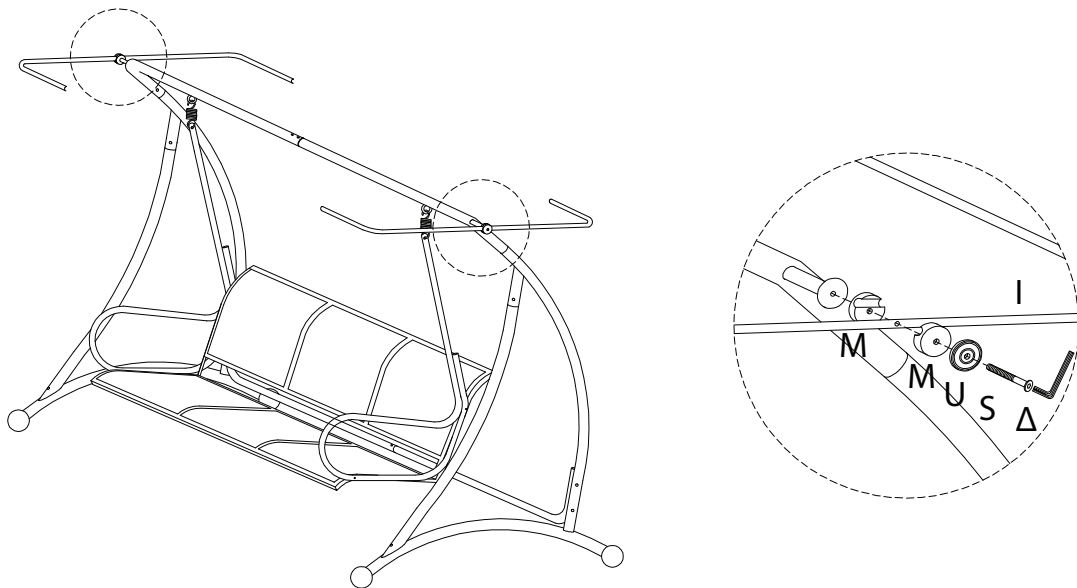

9

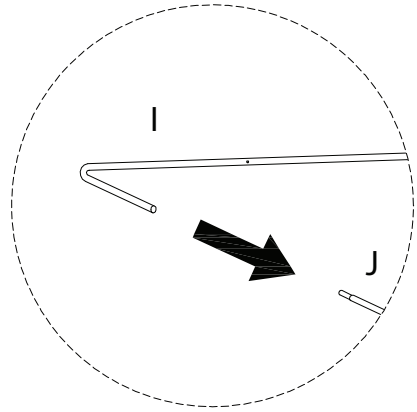
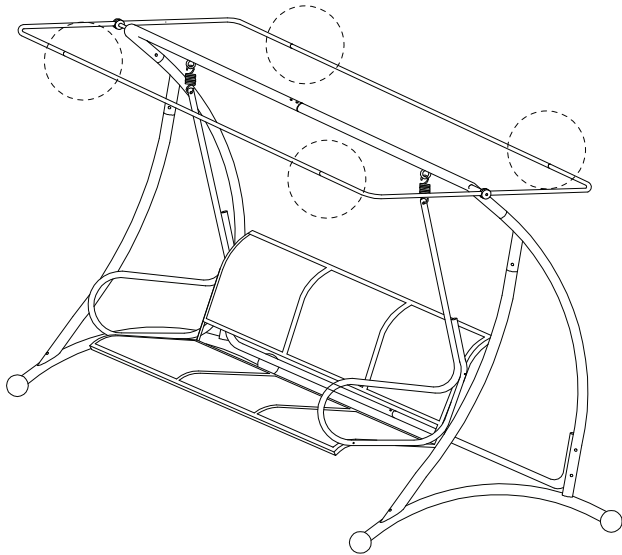
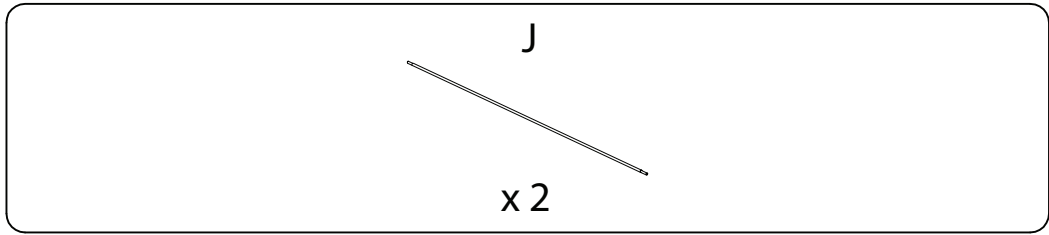

10

