

Montageanleitung für Viertelkreis-Dusche

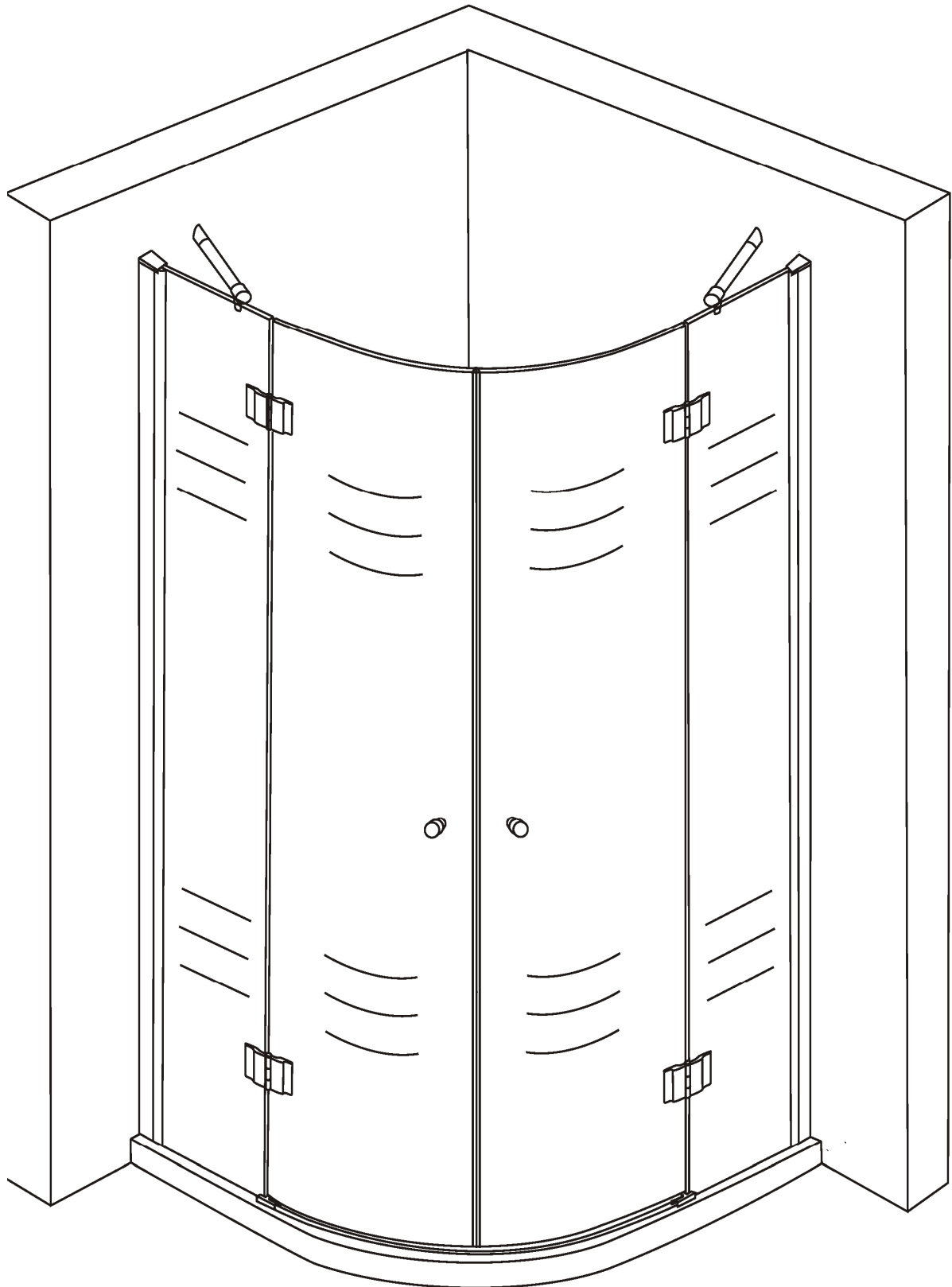

Benötigtes Werkzeug

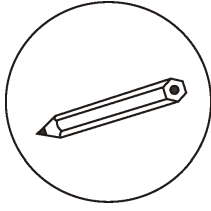

Stift

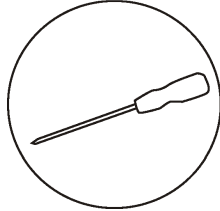

Schraubendreher (Kreuz)

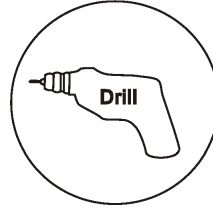

Bohrer

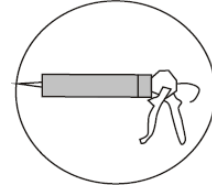

Silikon

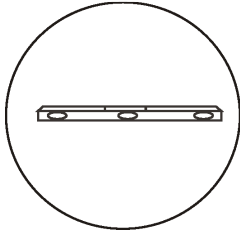

Wasserwaage

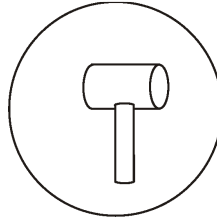

Gummi-Hammer

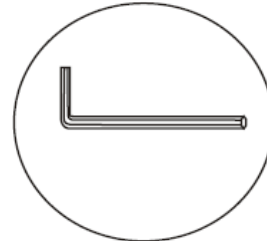

Imbusschlüssel

Teilleiste

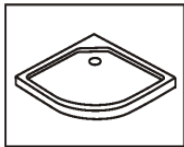

Tray

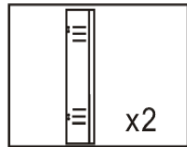

Glass

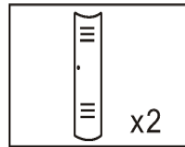

Glass

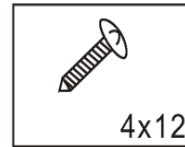

Screw



Screw

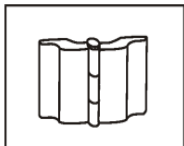

HY-3304

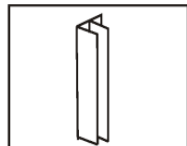

Wall profile

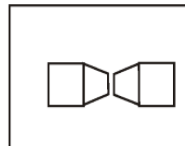

LS-1201

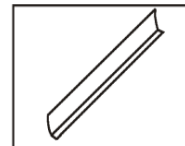

Side cover

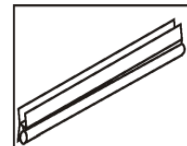

CT-8DSTQ



PJ-4317

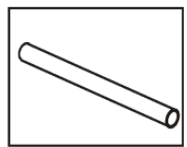

LG-2004

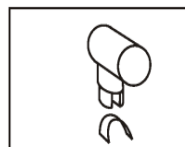

PJ-4416



CT-8BMX90

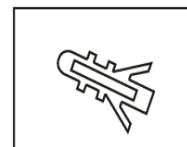

Expand tube

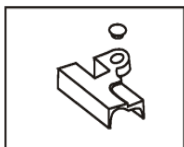

PJ-4526/
PJ-4527

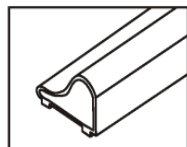

Aluminum
bottom bar

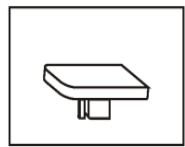

PJ-4509



PJ-4514/
PJ-4515

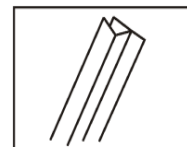

CT-8DST180

Markieren Sie die Montagelinien wie abgebildet

Maße	Wandprofil	L1	L2
800 x 800	Vorbohrung	765	765
900 x 900	Vorbohrung	865	865
1000 x 1000	Vorbohrung	965	965

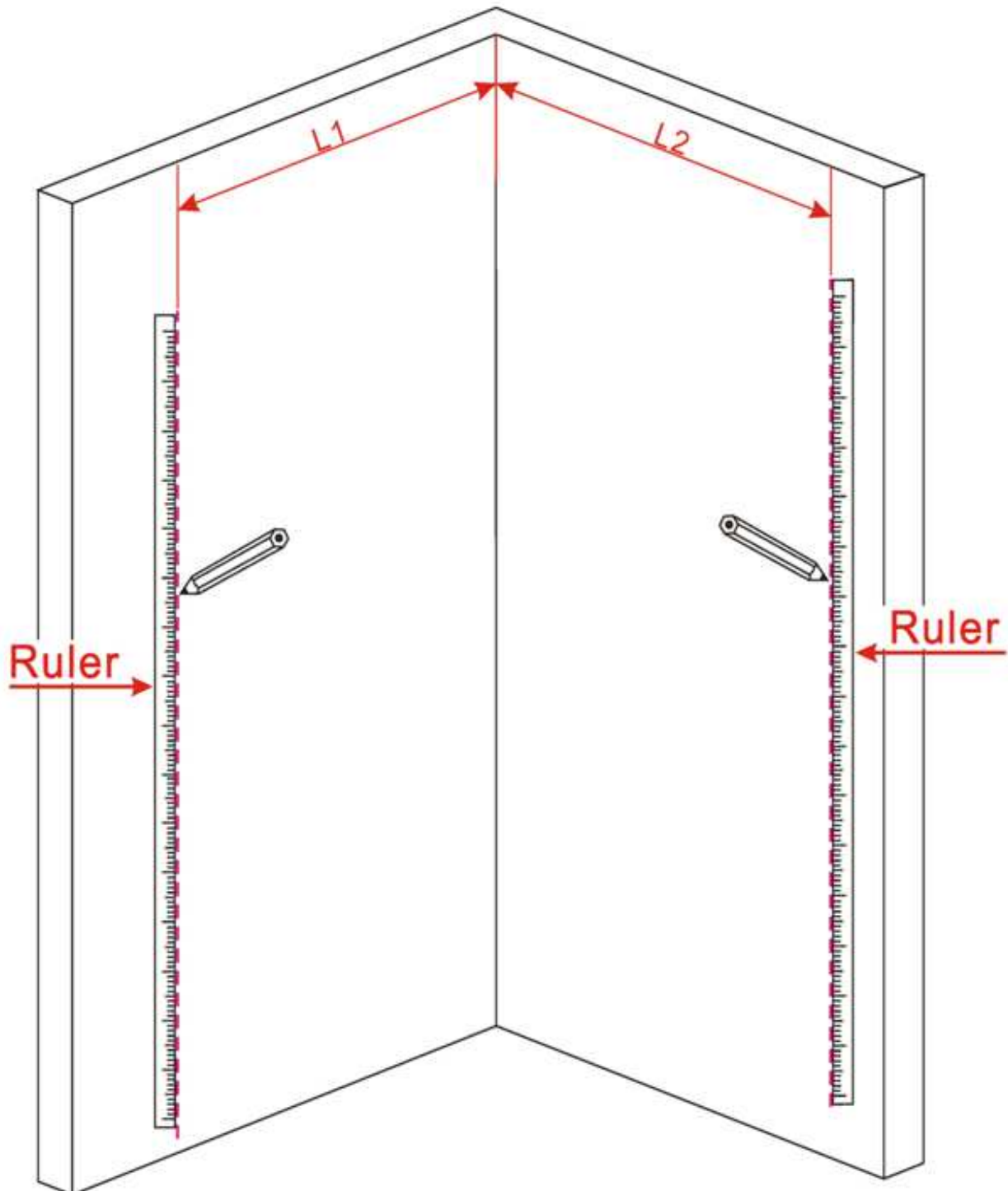

1. Platzieren Sie die Duschtasse
2. Stellen Sie die Wandprofile vertikal auf und nehmen Sie eine Wasserwaage zur Hilfe (die Vorbohrungen müssen sich auf der Montagelinie)
3. Markieren Sie die Bohr-Löcher
4. Bohren Sie an der Markierung und setzen Sie die Dübel
5. Schrauben Sie die Profile an die Wand

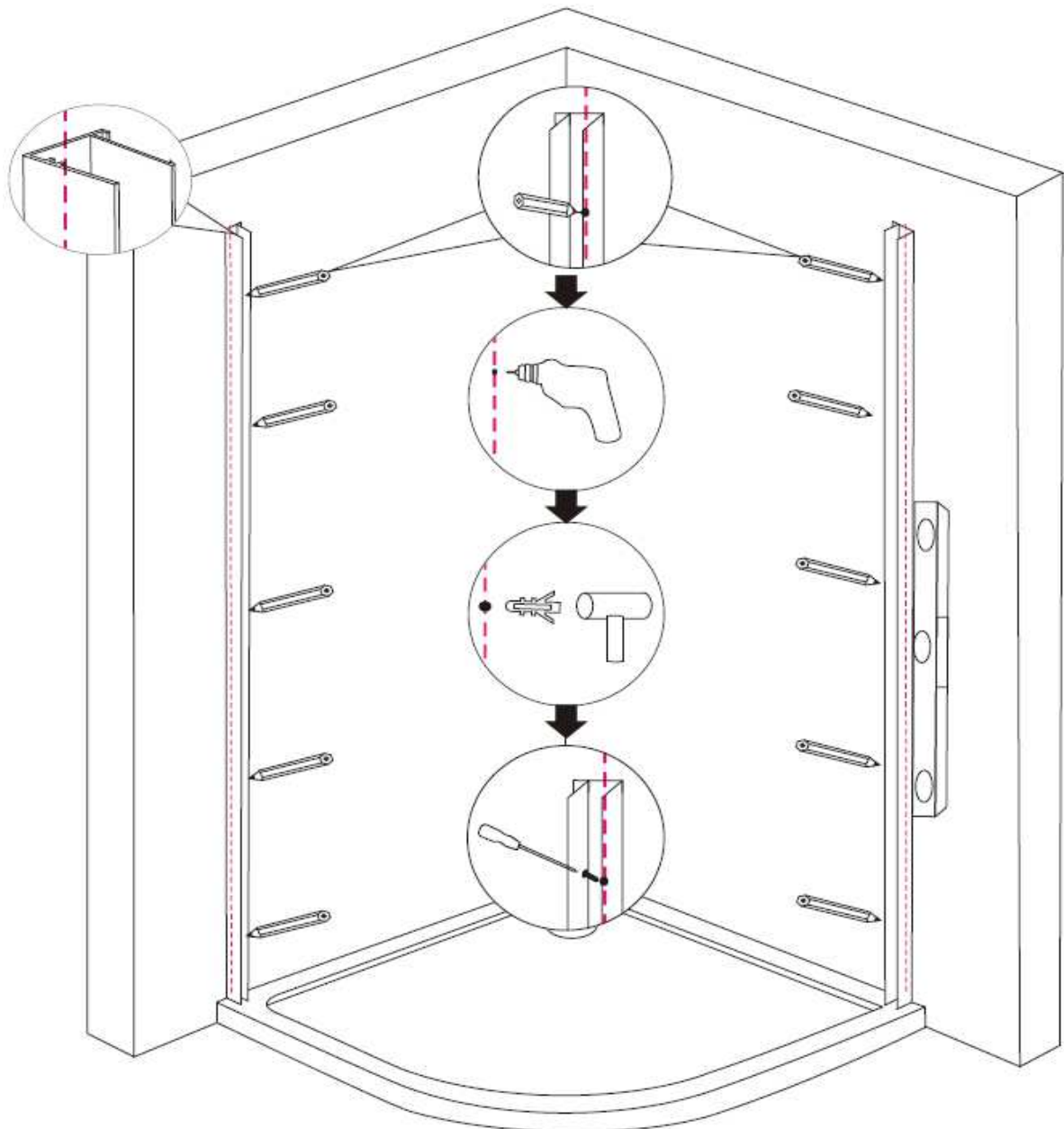

Führen Sie vorsichtig die beiden feststehenden Elemente in die jeweiligen Wandprofile (lassen Sie den Kantenschutz am Glas)

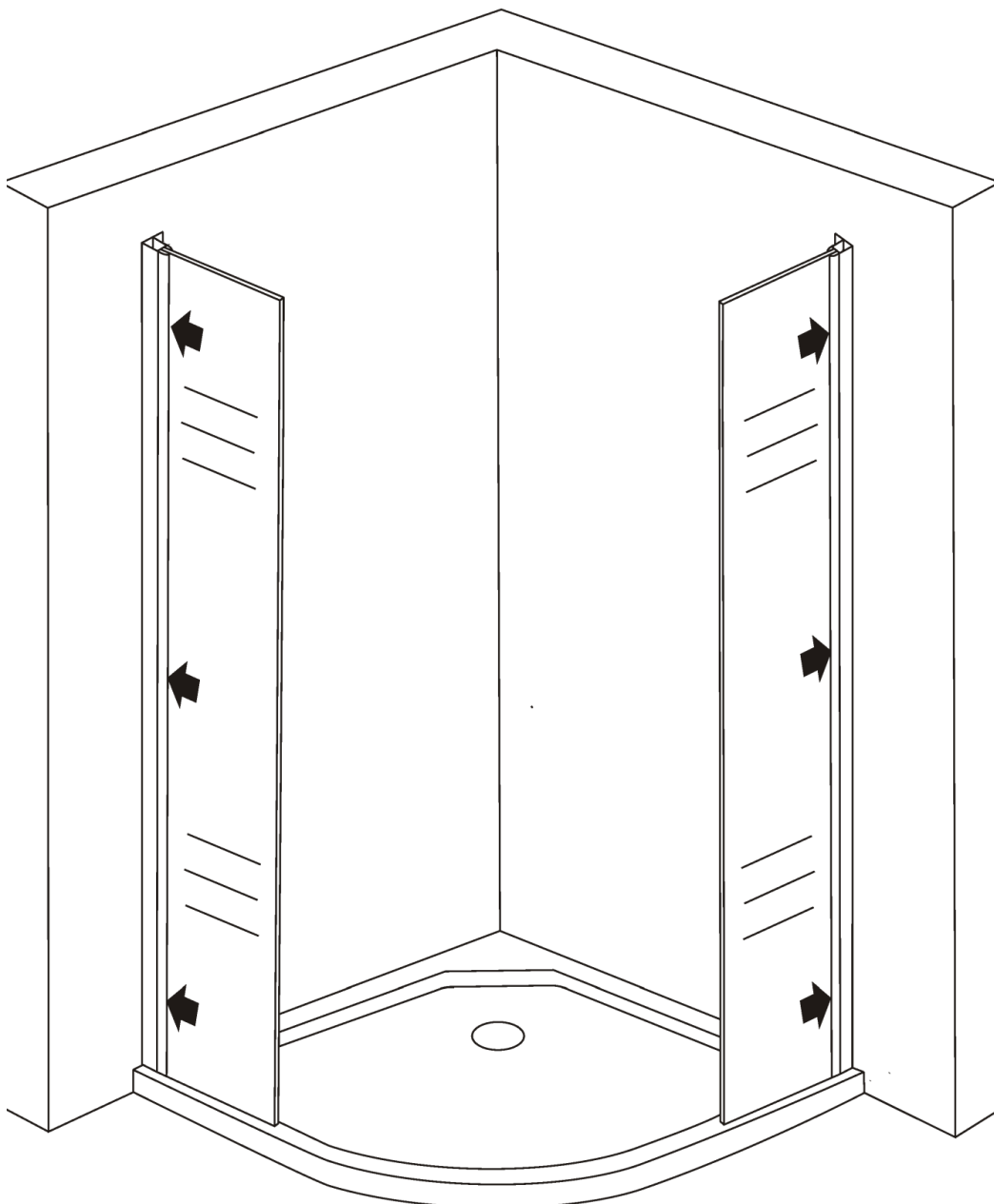
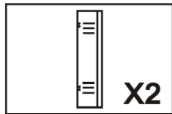

Bringen Sie die Scharniere an den feststehenden Elementen gemäß Bild an

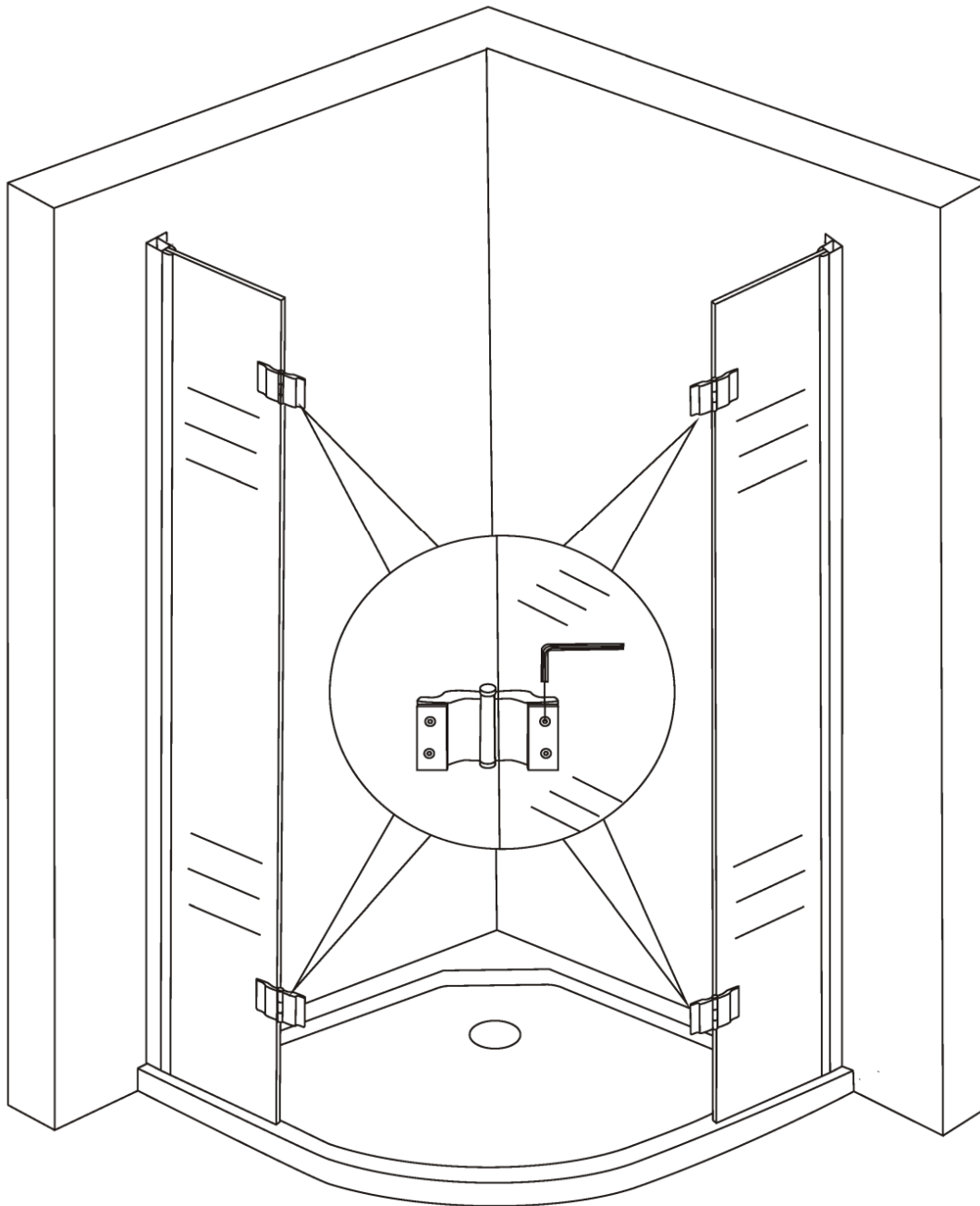

Bringen Sie die Dichtleisten gemäß Bild an

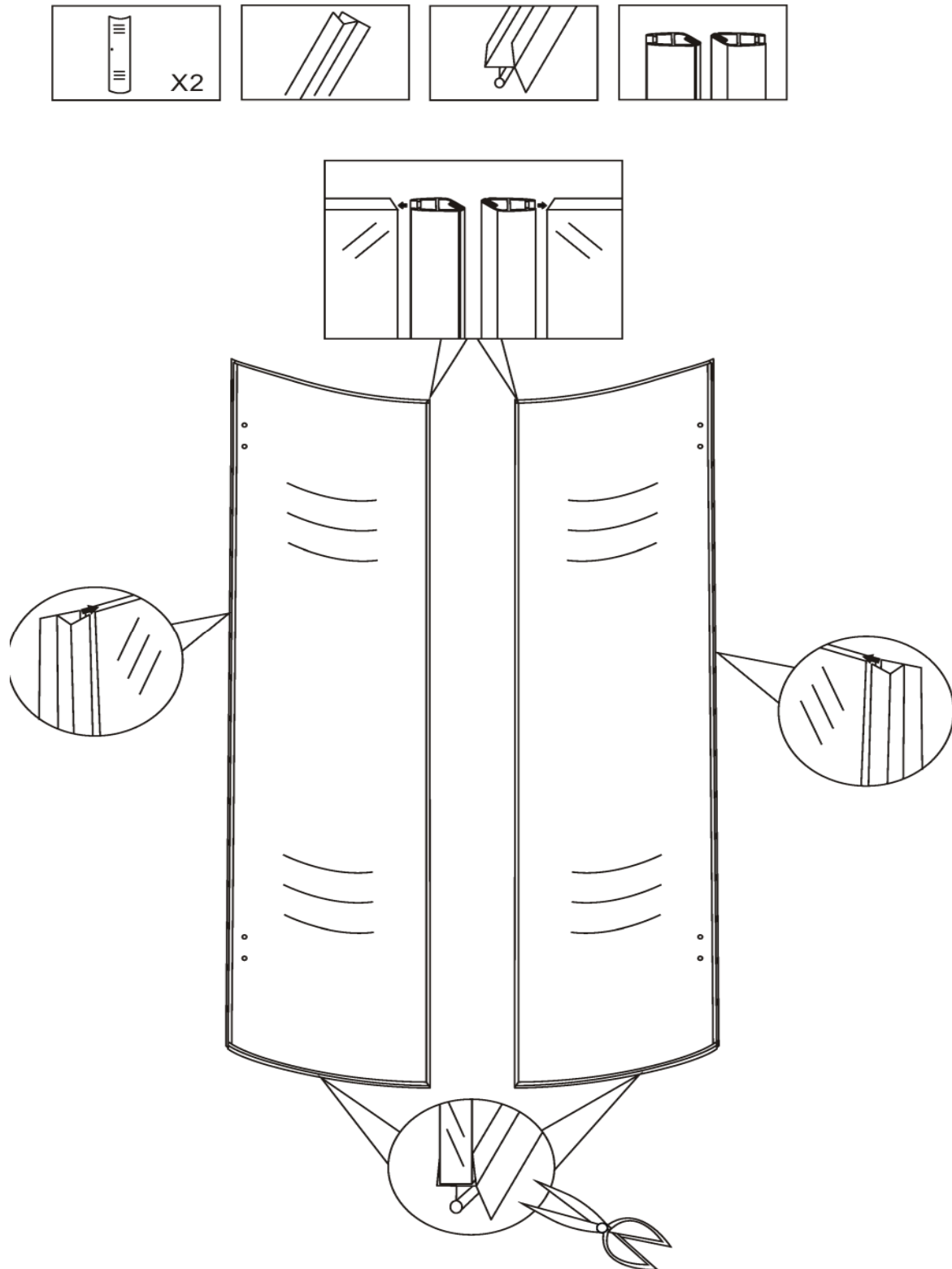

Lassen Sie die untere Tür-Dichtung überstehen und senken Sie die vertikalen Dichtleisten von oben auf „stoß“

1. Kleben Sie die Schwalleiste sowie die Halterungen vor der Tür auf die Duschtasse (ggf. den Fliesenboden) Bitte NICHT verschrauben
2. Verschrauben Sie die Türen mit den jeweiligen Scharnieren

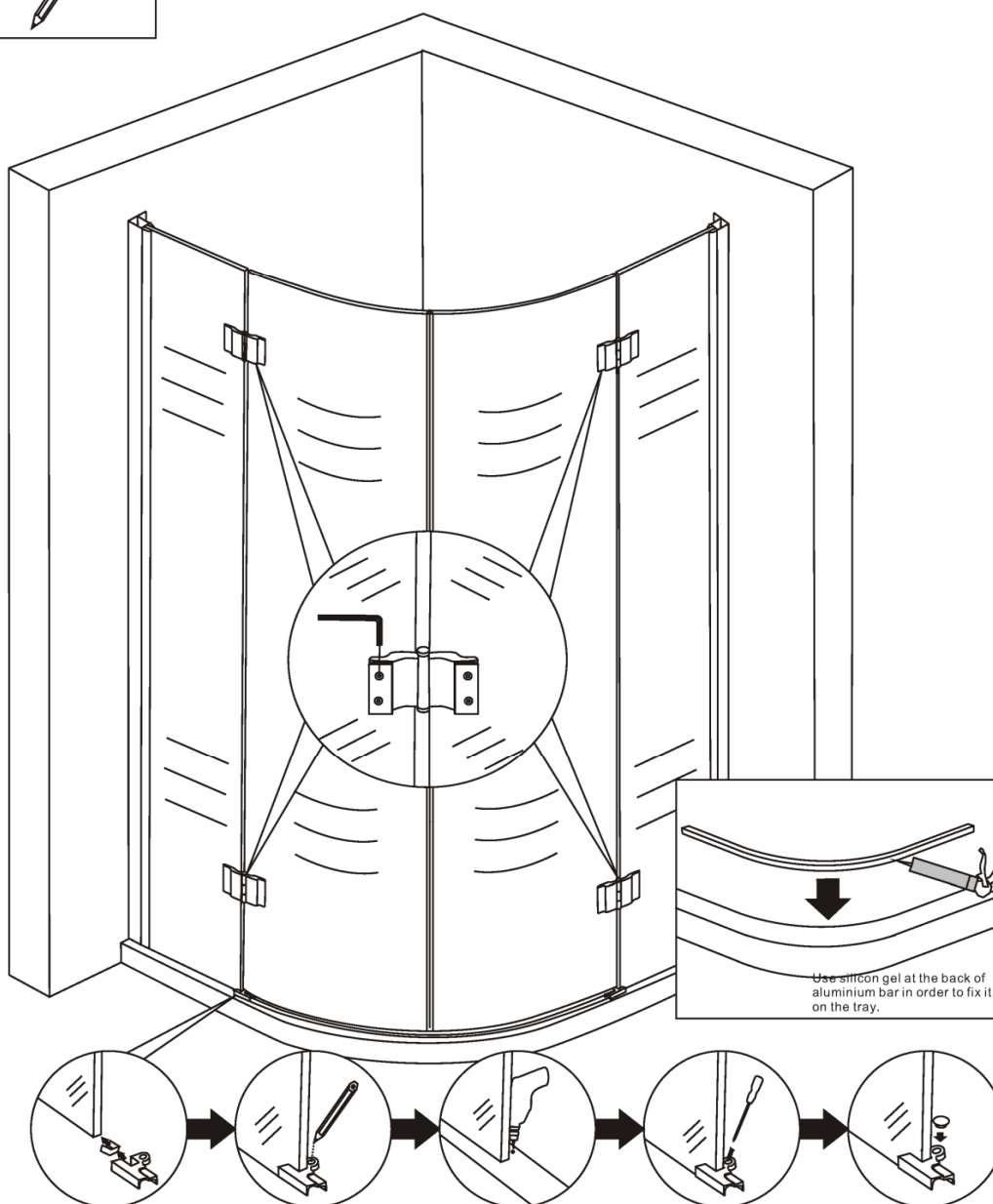
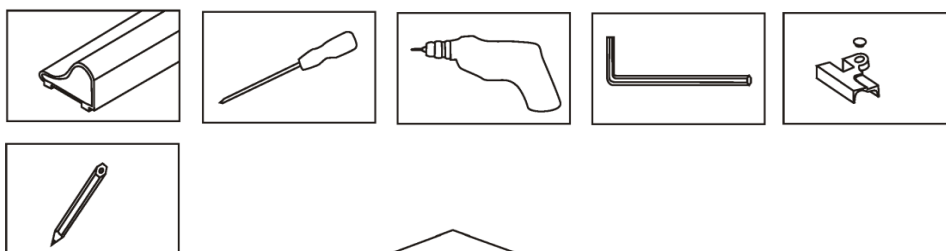

1. Bohren Sie an den vorgesehenen Stellen durch die Wandprofile und fixieren Sie die feststehenden Elemente mittels der beigefügten Schrauben
2. Bringen Sie anschließend die Abdeckleiste zwecks Verdeckung der Verschraubung an, diese ist ein zu klinken

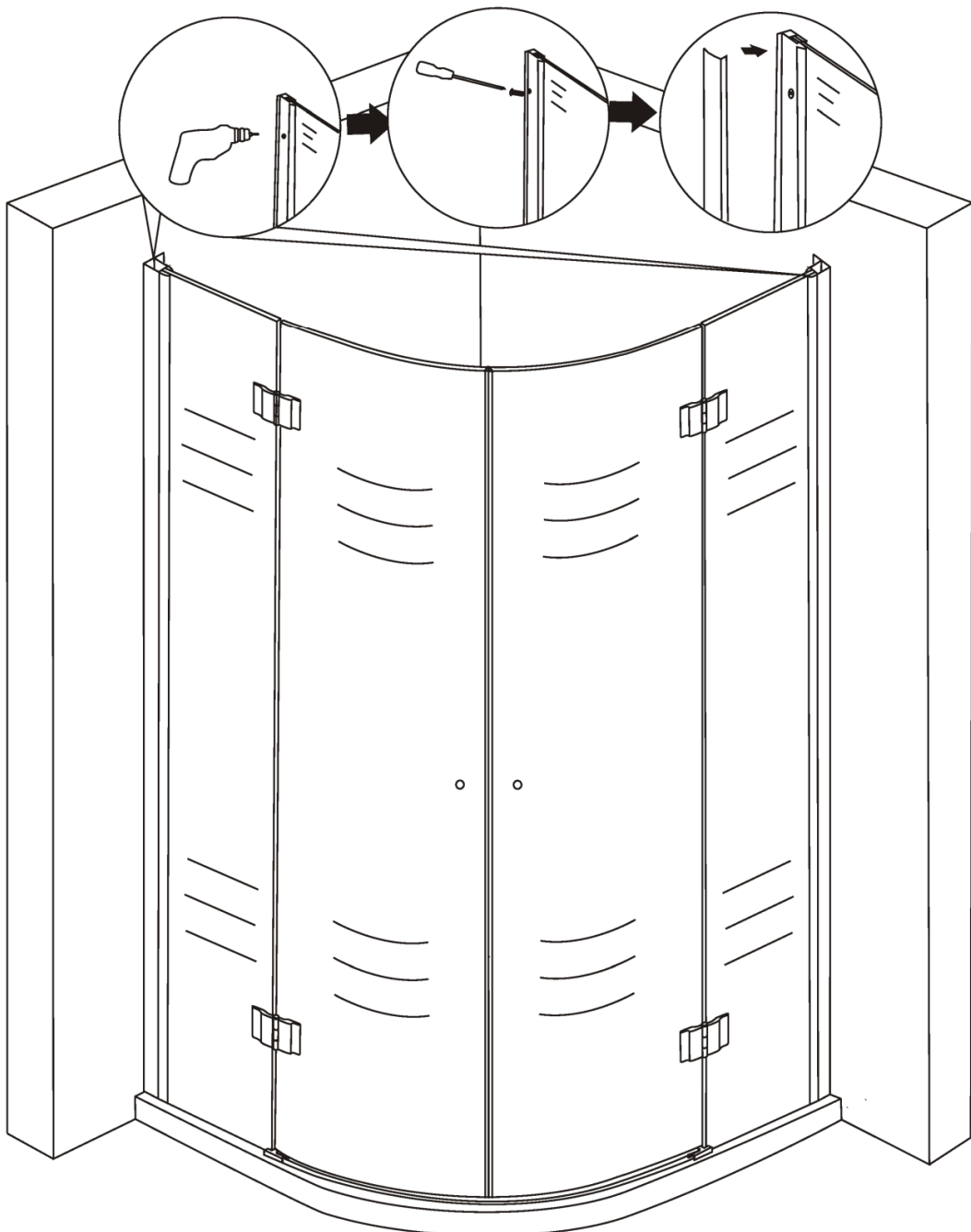
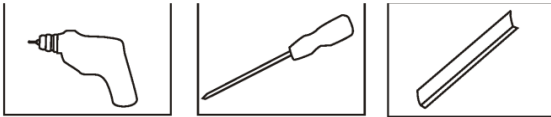

Installieren Sie die beiden Haltestangen an den feststehenden Elementen entsprechend dem nachfolgenden Bild

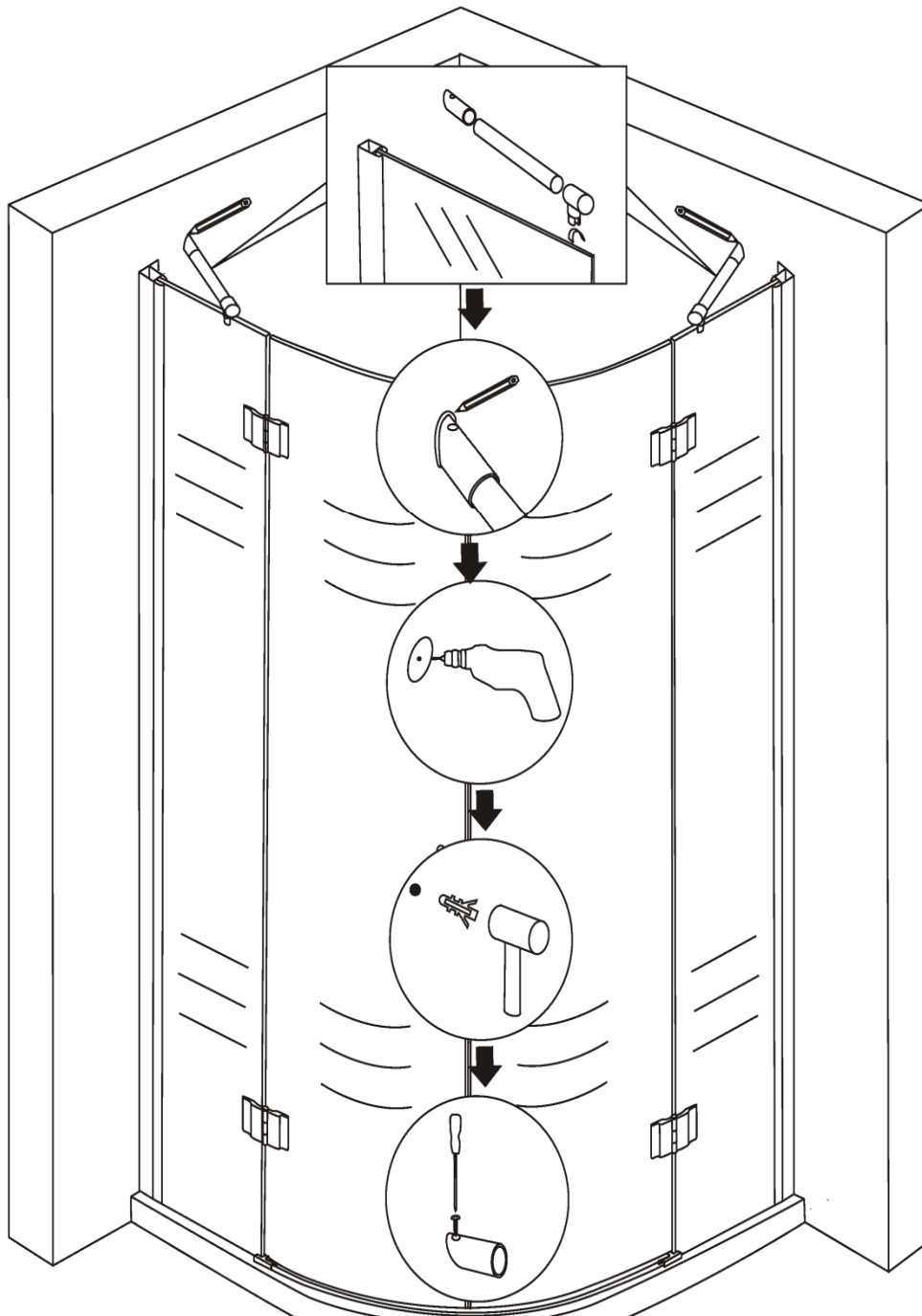
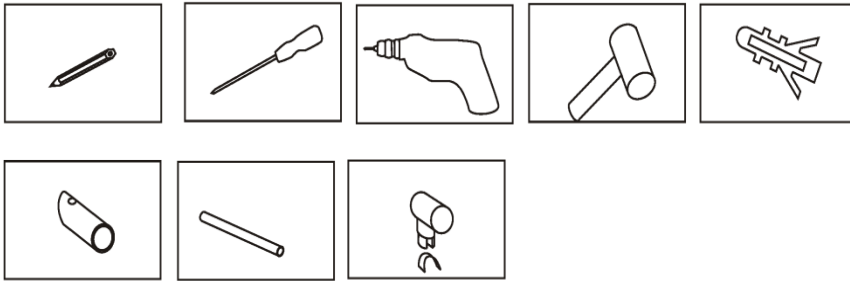

1. Verschrauben Sie die Türgriffe und bringen Sie die oberen Profilabdeckungen an
2. Versiegeln Sie die feststehenden Elemente und die Wandprofile mittels Silikon von innen und außen

