

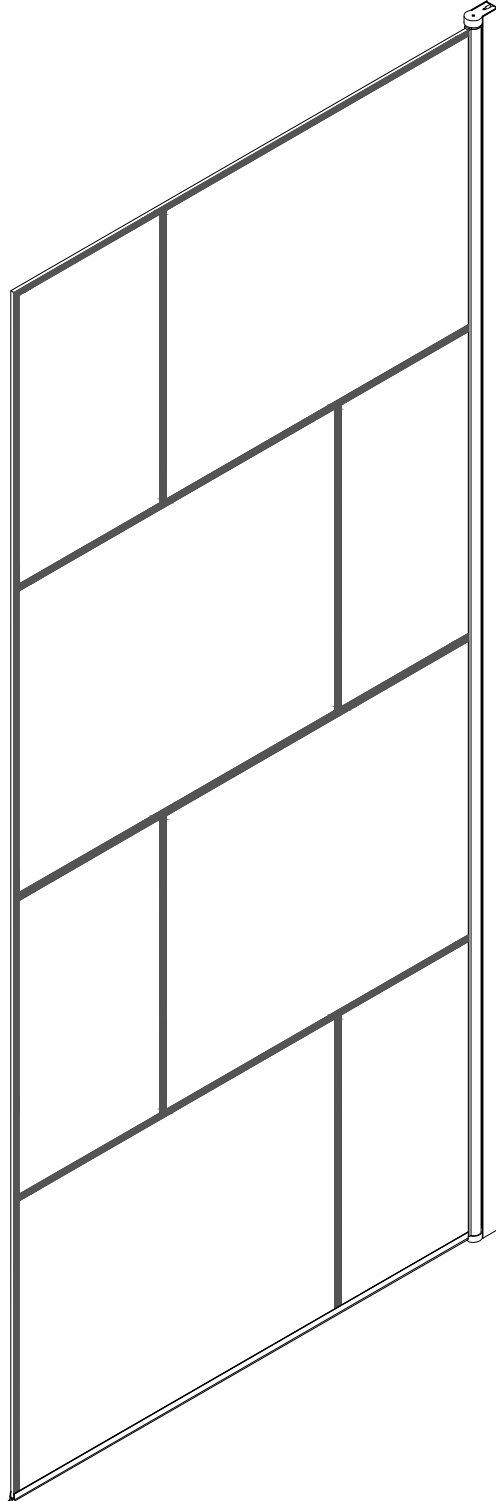

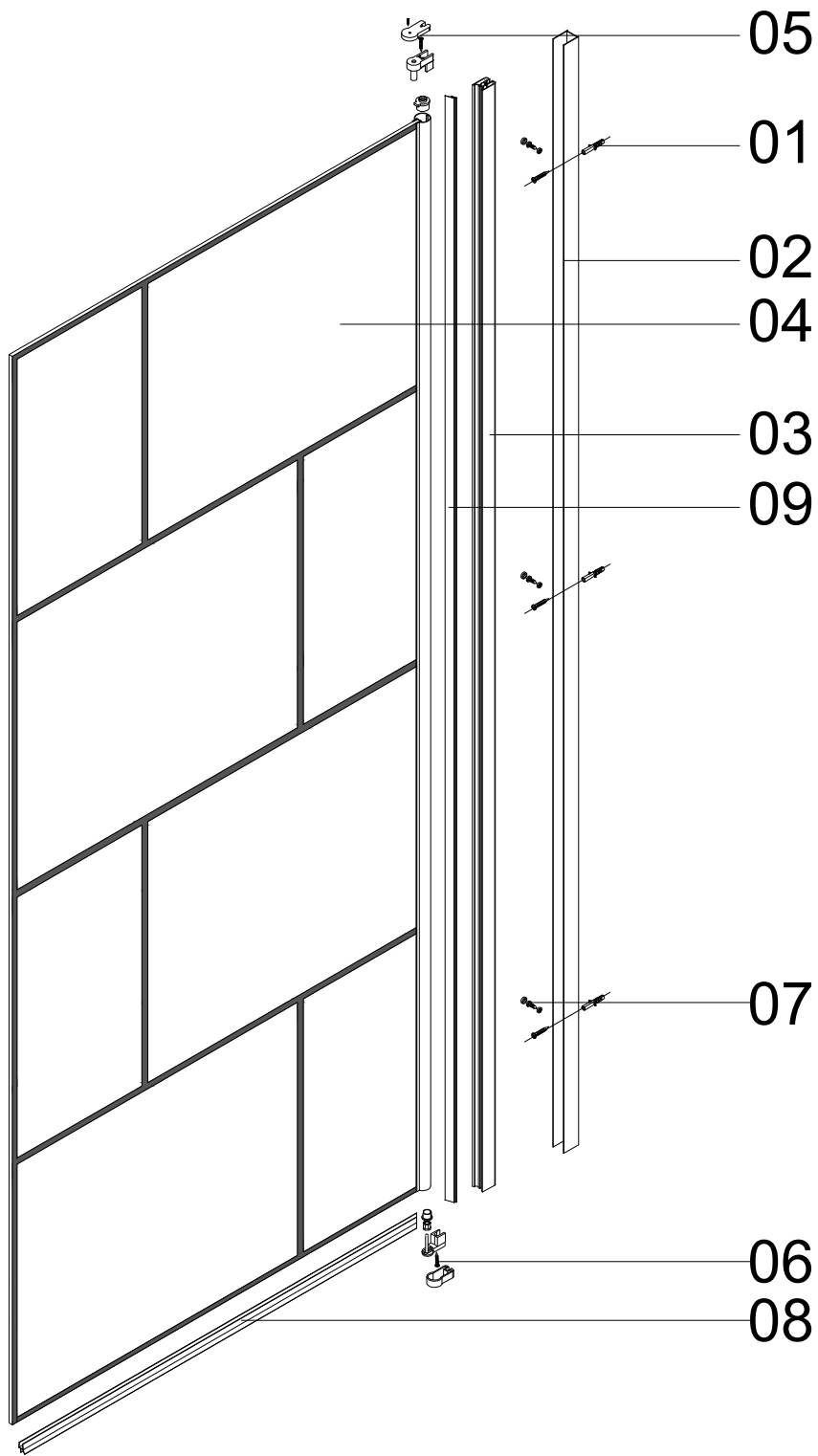



PARE BAIGNOIRE BRICKS 125X75
FAC591
75X125cm





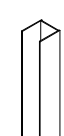

01 AURL967

 AURL959
 ST4X25 X3

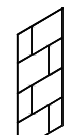
02 AURL1327

 X1

03 AURL1328

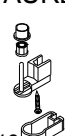
 X1

04

 X1

05 AURL1324

 ST4X12
 ST4X18 X1

06 AURL1324

 ST4X18 X1

07 AURL953

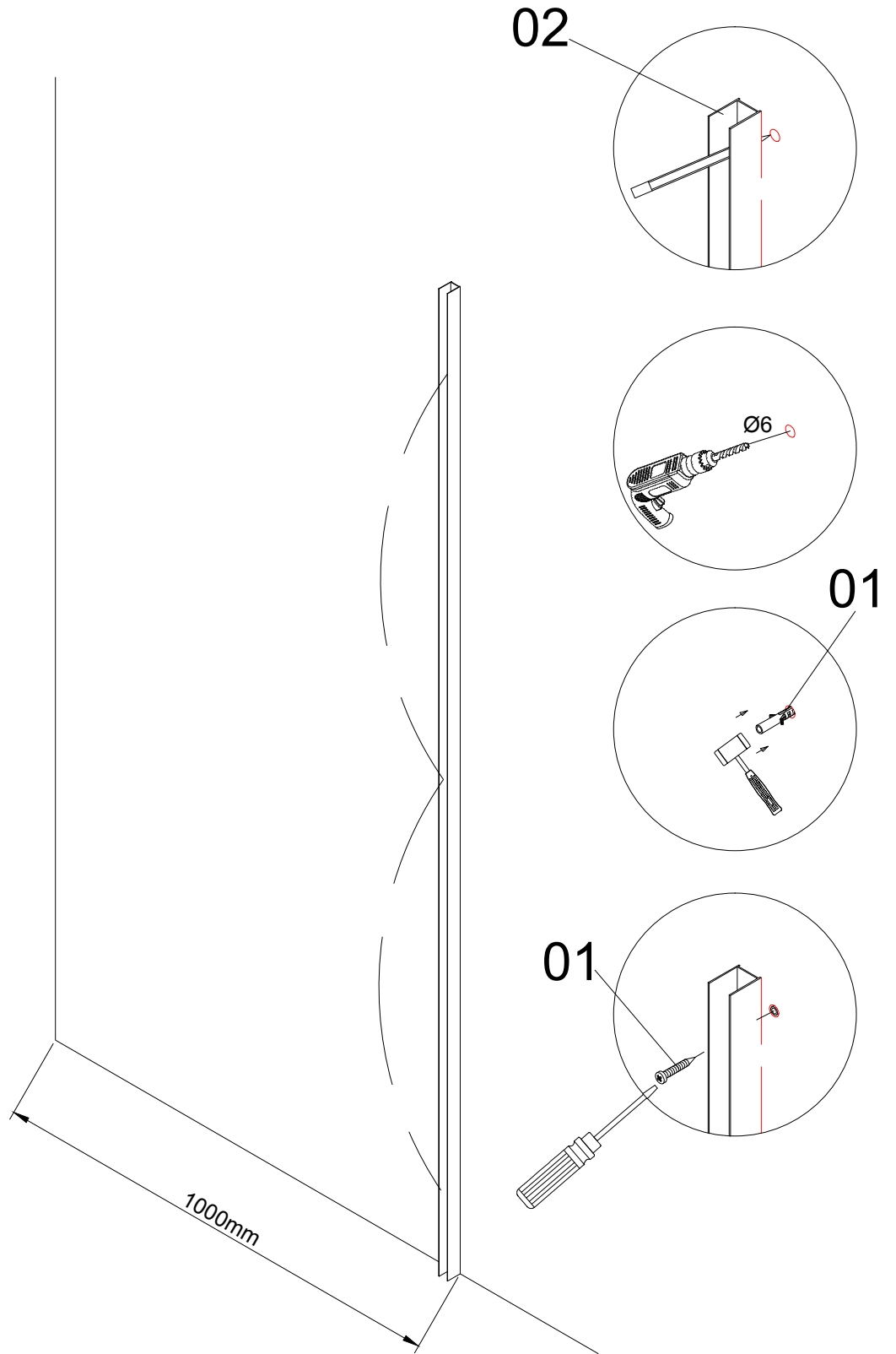
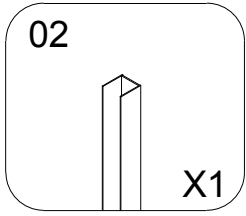
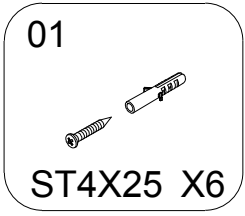
 AURL973
 ST4X10 X3

08 AURL1325

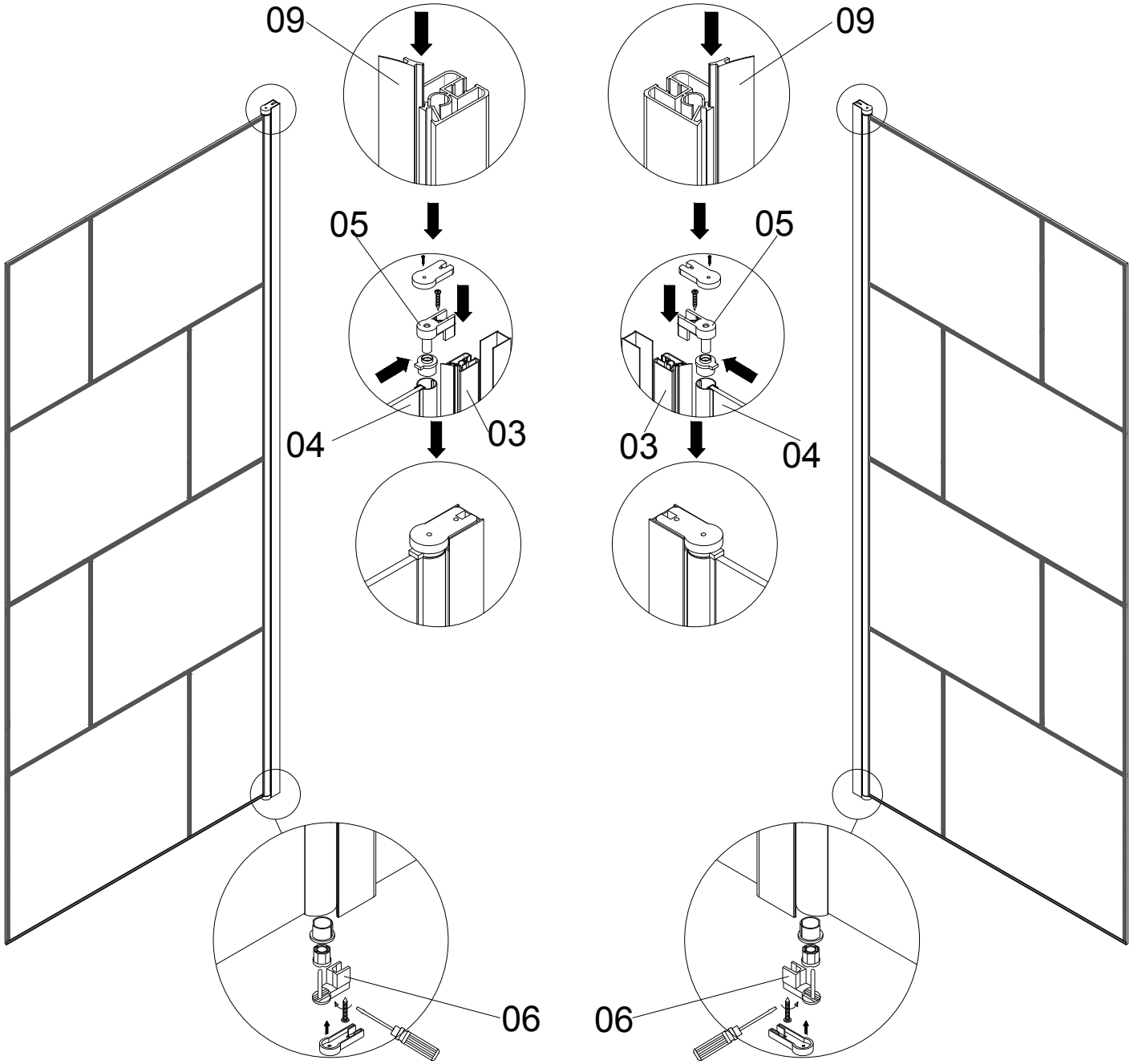
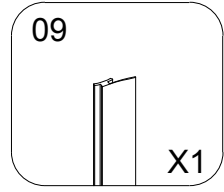
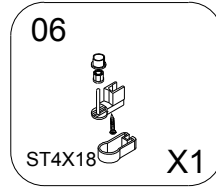
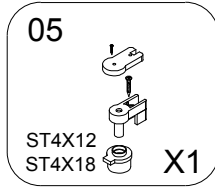
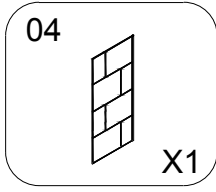
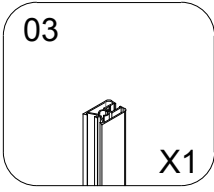
 X1

09 AURL1326

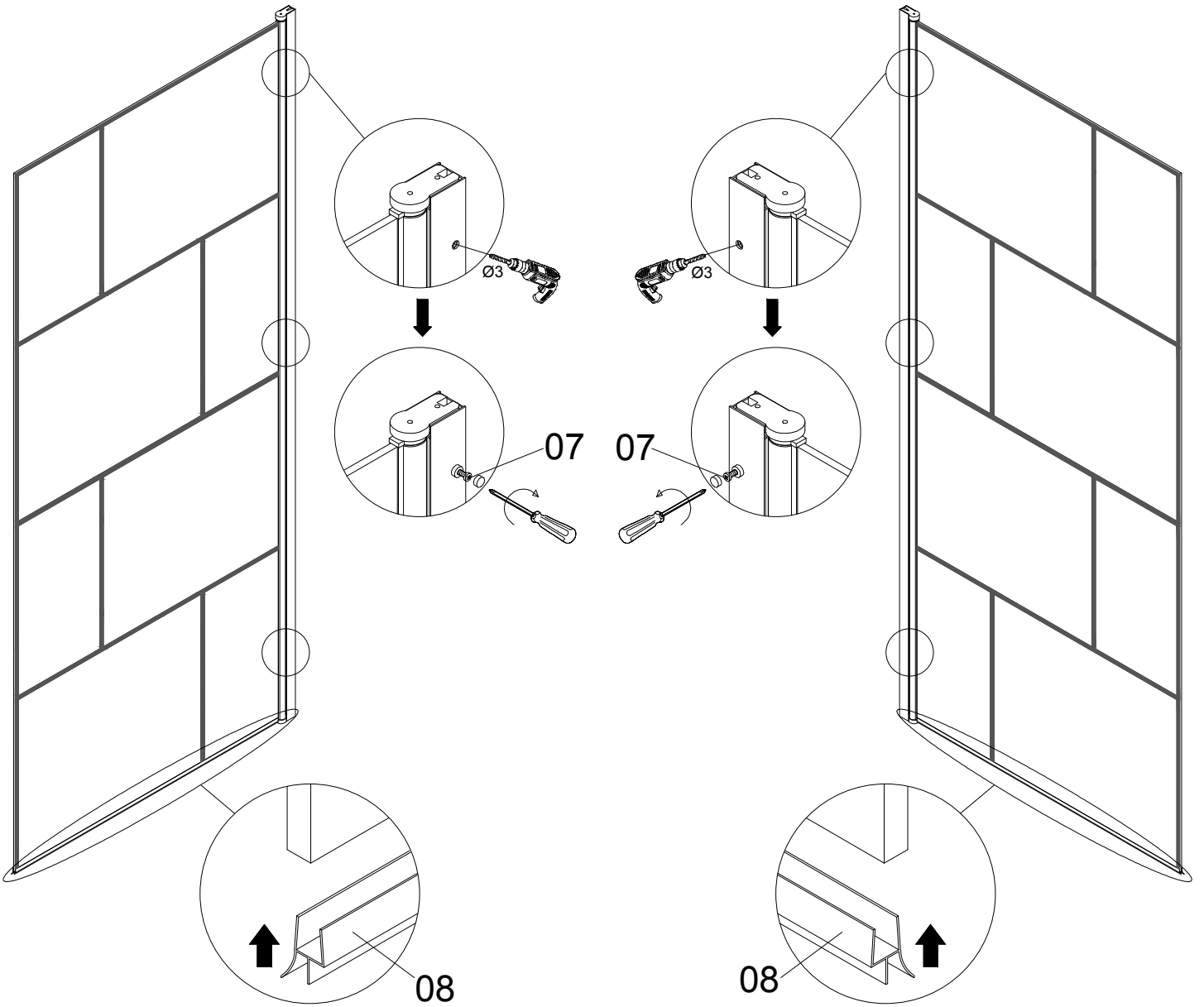
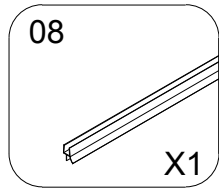
 X1



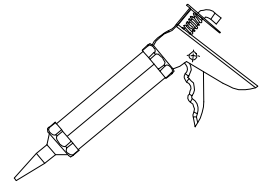
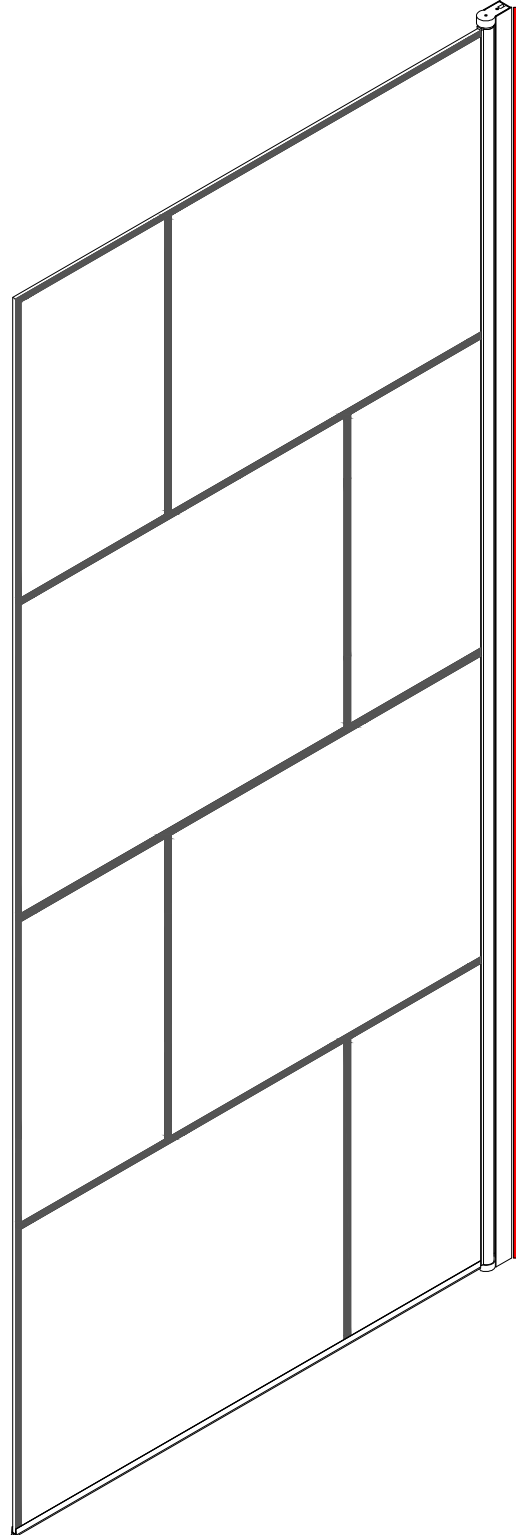
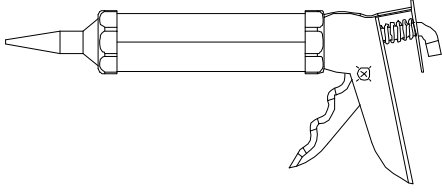





DÉCLARATION DES PERFORMANCES

N o DoP_FAC_030

1. Code d'identification du produit Type : BRICKS

Par extension, la présente déclaration des performances est applicable aux produits détaillés en annexe.

2. Usage(s) prévu(s) : PAROIS DE DOUCHE POUR HYGIENE PERSONNEL-PH.....

3. Fabricant :AURLANE 32 rue Washington 75008 PARIS.....

4. Mandataire :Non applicable.....

5. Système(s) d'évaluation et de vérification de la constance des performances: système 4.....

6a. Norme harmonisée: EN14428:2004

Organisme(s) notifié(s) : Non applicable

6b. Document d'évaluation européen Non applicable

Evaluation technique européenne Non applicable

Organisme d'évaluation technique Non applicable

Organisme(s) notifié(s) Non applicable

7. Performances déclarées

Caractéristiques essentielles	Performances	Spécifications techniques harmonisées
Aptitude au nettoyage	Exigences satisfaites	EN14428:2004+A1:2008 Clause 4.2
Résistance à l'impact / Propriétés d'éclatement	Exigences satisfaites	EN14428:2004+A1:2008 Clause 4.3
Durabilité	Exigences satisfaites	EN14428:2004+A1:2008 Clause 4.4

Les performances du produit identifié ci-dessus sont conformes aux performances déclarées.

Conformément au règlement (UE) n°305/2011, la présente déclaration des performances est établie sous la seule responsabilité du fabricant mentionné ci-dessus.

Signé au nom du fabricant par:

Sébastien Doumenc
Directeur associé Aurlane
A paris, le 03/02/2020



ANNEXE 1 références

code_produit	Designation
FAC586	BRICKS 90
FAC587	BRICKS 100
FAC588	BRICKS 120
FAC589	BRICKS 140
FAC590	BRICKS 90+40
FAC591	PARE BAIGNOIRE BRICKS 125X75

ANNEXE 2 marquage CE

