

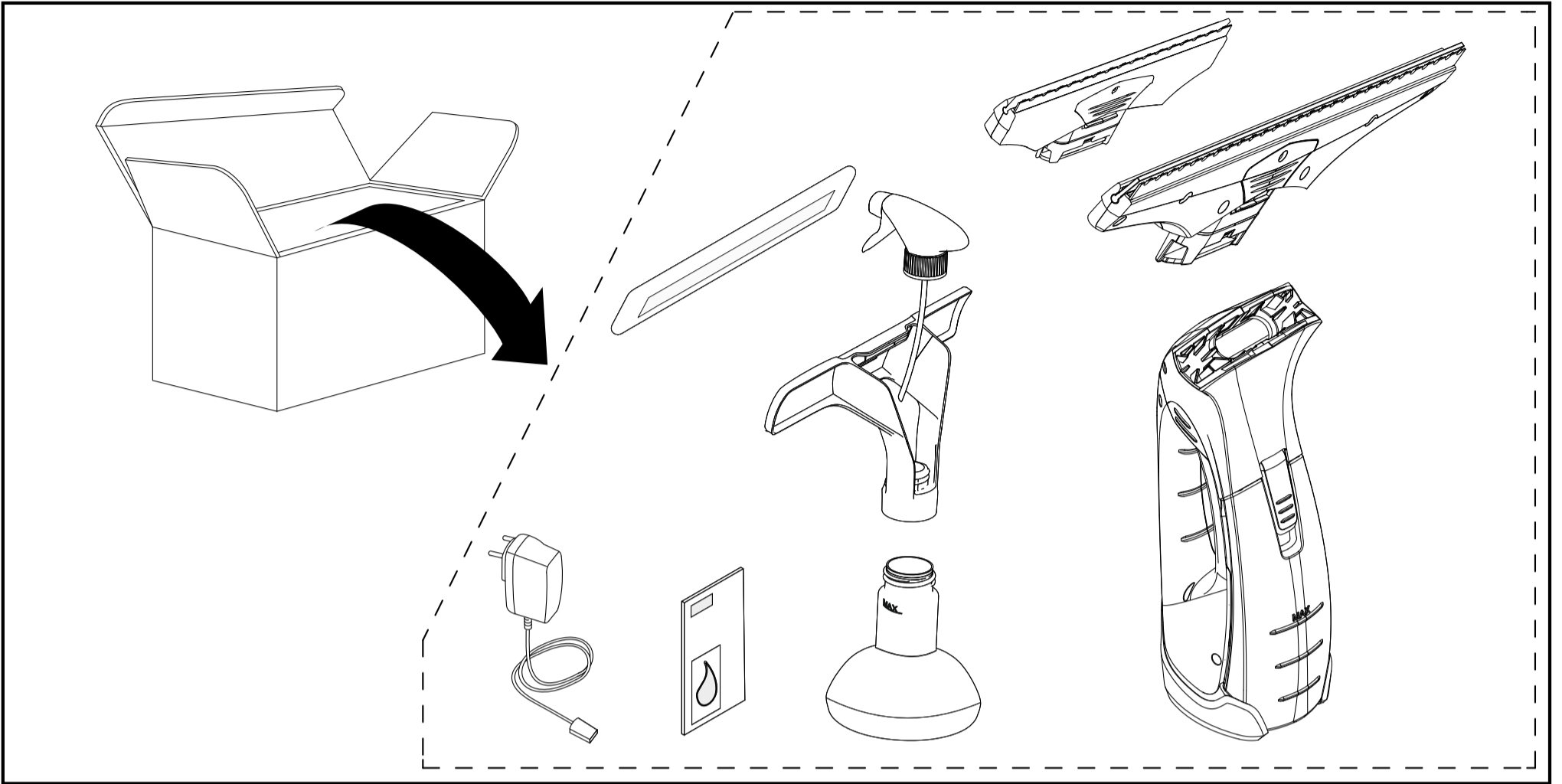

## WV 2 Premium

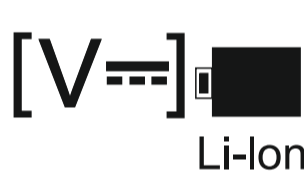

 Li-Ion	3,7 V		IP X4		0,6 kg
 nom	10 W		100 ml		120 min
	V 5,5 mA 600		50 db(A)		25 min

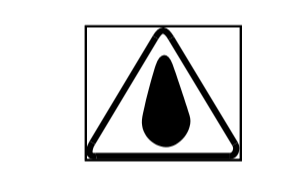
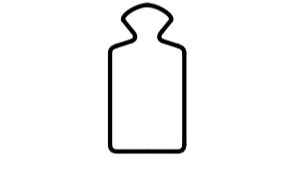
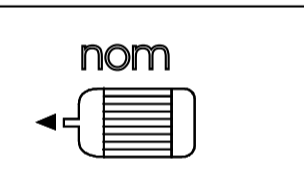
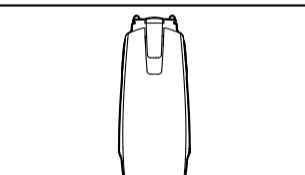
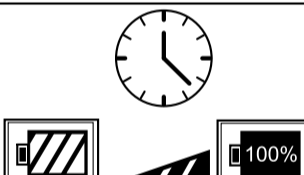
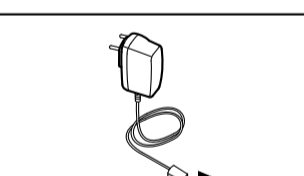
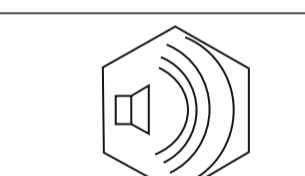
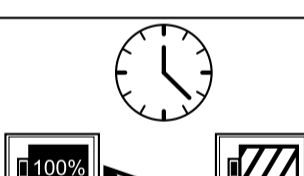
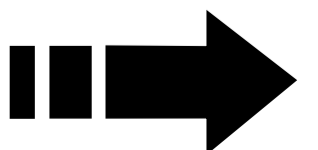

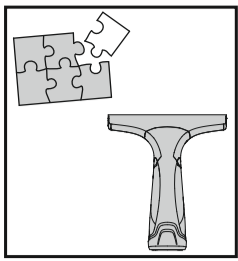

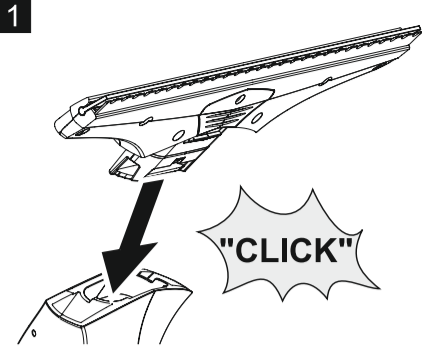
**1** 

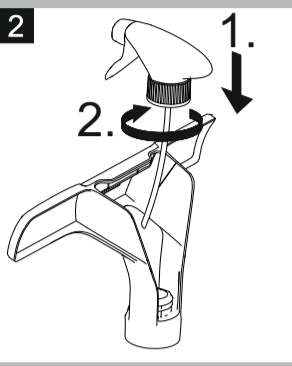
**2** 

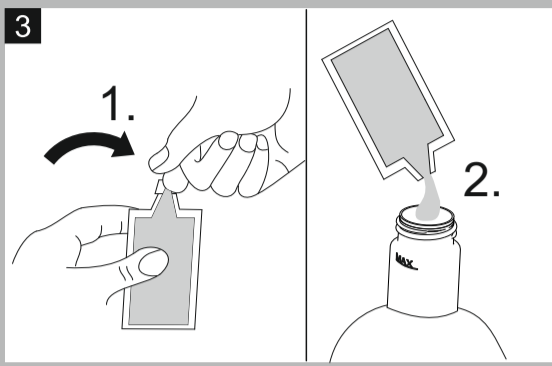
**3** 

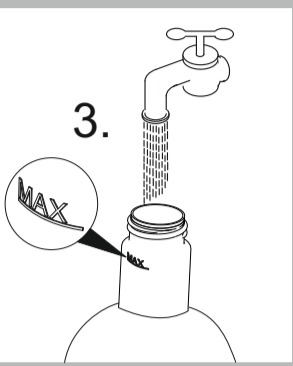
**3.** 

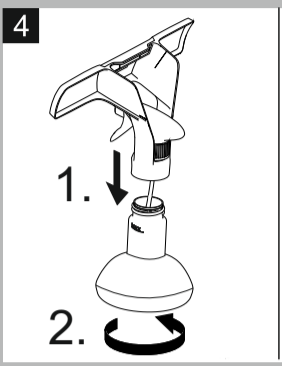
**4** 

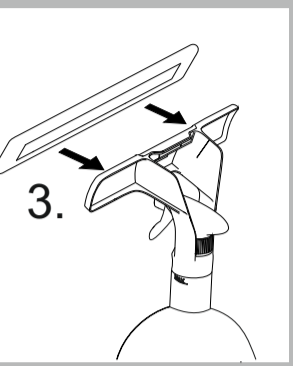
**3.** 

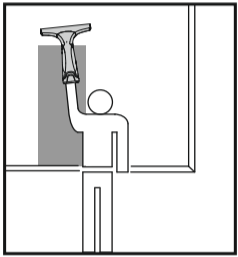

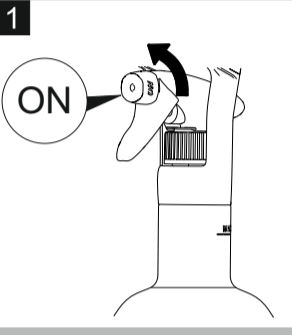
**1** 

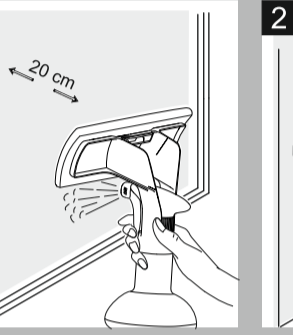
**2** 

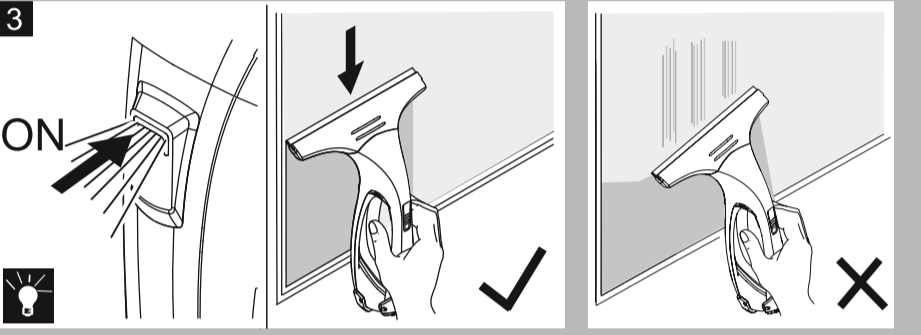
**3** 

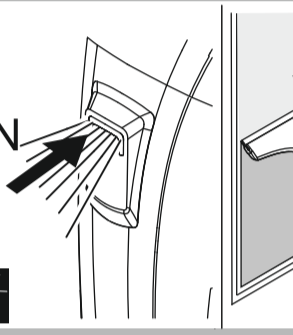
**ON** 

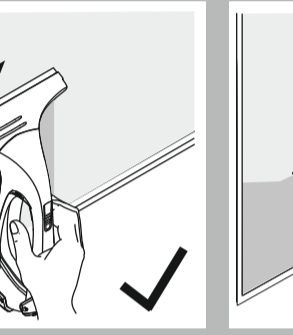

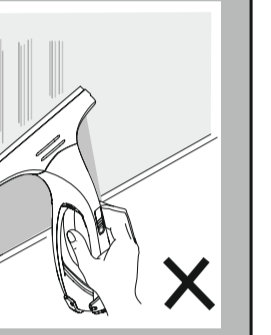

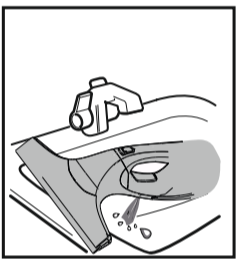

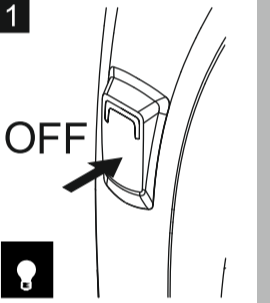
**1** 

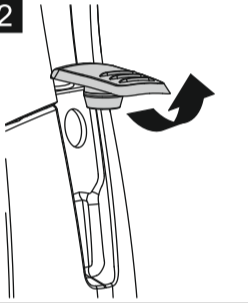
**2** 

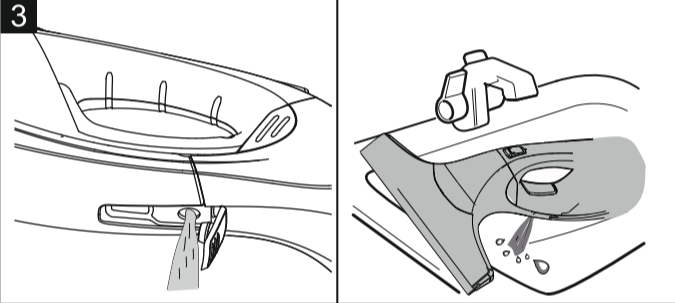
**3** 

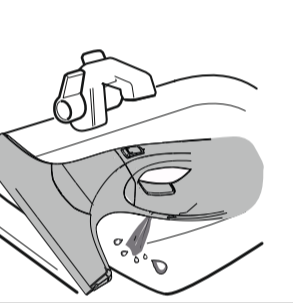



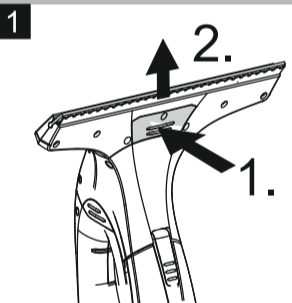

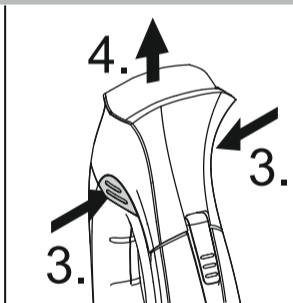
**1** 

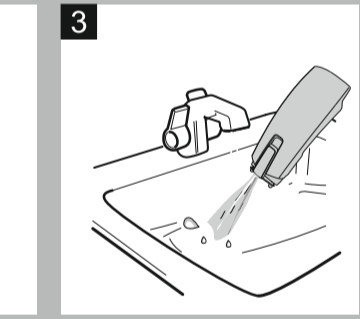
**2** 

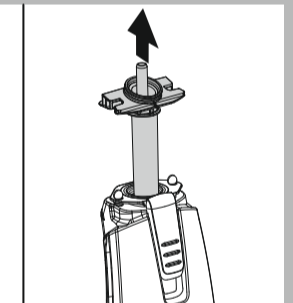
**2** 

**3** 

**3** 

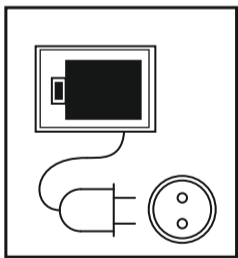

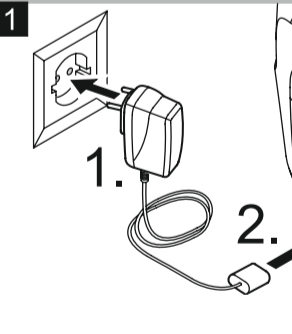
**1** 

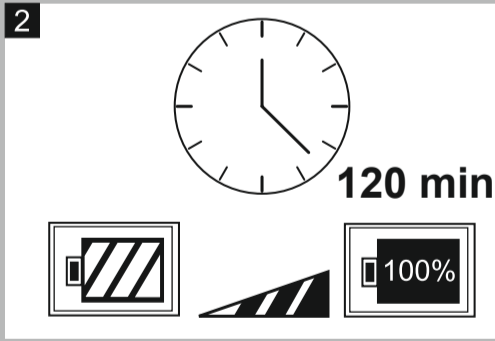
**2** 

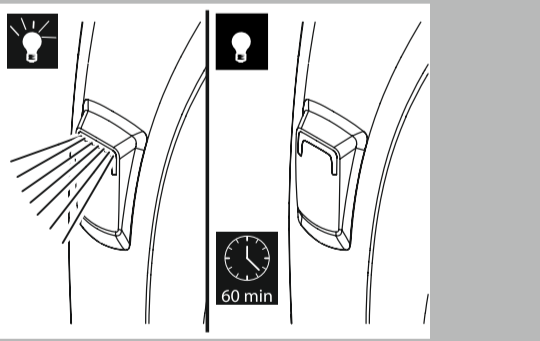
**3** 

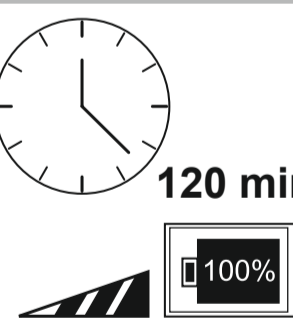
**100%** 

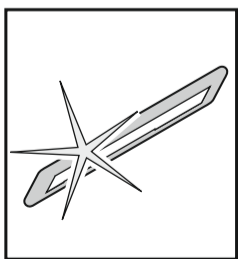

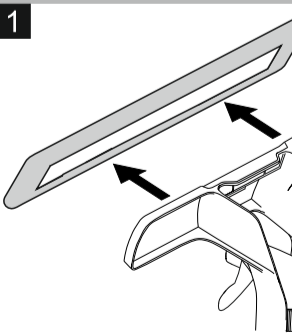
**1** 

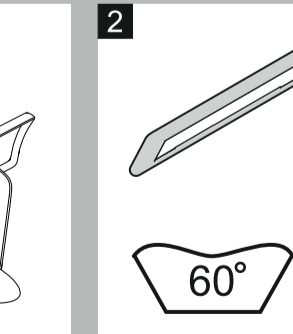
**2** 

**60°** 