

HYUNDAI

PETROL LAWN MOWER

HYM43SP-2 /HYM430SP

HYM46SP-2 / HYM460SP

HYM51SP-2 / HYM510SP

User Manual

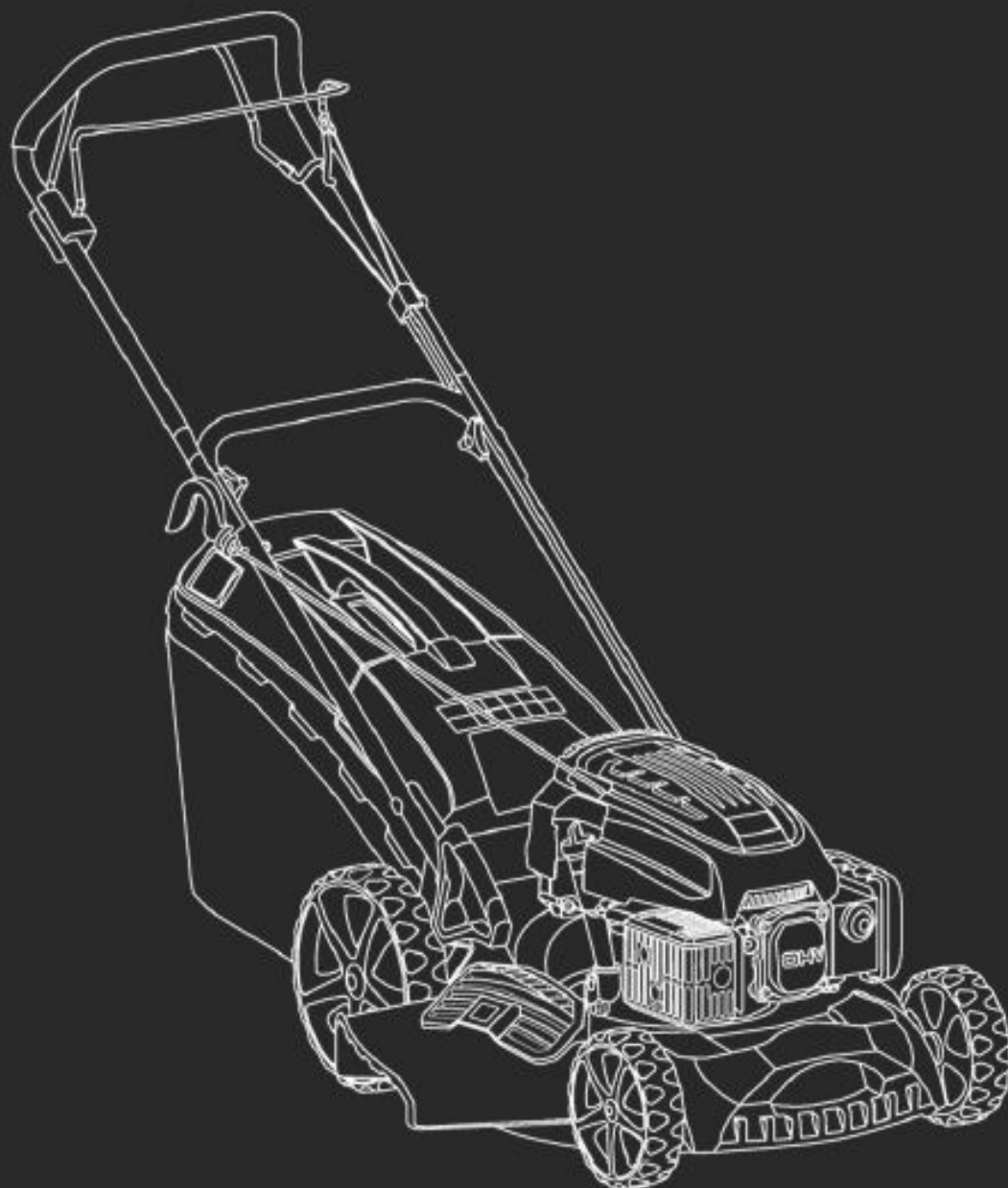

INDEX

	CONTENTS	PAGE NO.S
1	SAFETY	3 - 7
2	PART LOCATIONS	8
3	QUICK START GUIDE	9 - 12
4	STARTING PROCEDURE	13 - 14
5	STOPPING PROCEDURE	14
6	USING THE MACHINE	15 - 16
7	MAINTENANCE	17 - 21
8	TROUBLESHOOTING	22
9	SPECIFICATION	23
10	RECYCLING	24
11	DECLARATION OF CONFORMITY	25
12	CONTACT DETAILS	26

1. SAFETY

1.1 General Safety Notes.

- 1.2 The operator of the machine is responsible for, and has a duty of care in making sure that the machine is operated safely and in accordance with the instructions in this user manual. Keep the manual safe and pass it on if the machine is loaned or sold to another user.
- 1.3 Please note the following safety points.
- 1.4 The machine should never be left in a condition which would allow an untrained or unauthorised person/s to operate this machine.
- 1.5 All due care and diligence should be taken by the operator for the safety of and with regard to those around whilst using the machine.
- 1.6 Some or all of the following - warning signs, symbols and/or PPE pictograms may appear throughout this manual. You **MUST** adhere to their warnings. Failure to do so may result in personal injury to yourself or those around you.



DANGER

Indicates a hazard, which, if not avoided, could result in serious injury or death.



WARNING

Indicates a hazard, which, if not avoided, could result in serious injury.



CAUTION

Indicates a hazard which, if not avoided, might result in minor or moderate injury.



NOTE

Indicates a situation that could easily result in equipment damage.

READ and keep the manual safe and pass it on if the machine is loaned or sold to another user.

You **MUST** fully understand all instructions to ensure you use and operate the machine safely.

Appropriate Personal Protective Equipment (PPE), **MUST** be worn at all times when operating or repairing the machine.



HAND
PROTECTION
MUST BE WORN



EYE
PROTECTION
MUST BE WORN



PROTECTIVE
CLOTHING
MUST BE WORN



HEARING
PROTECTION
MUST BE WORN



FOOT
PROTECTION
MUST BE WORN



HEAD
PROTECTION
MUST BE WORN



RESPIRATOR
MUST BE WORN



FACE SHIELD
MUST BE WORN



1.10 Carbon Monoxide (where applicable).

- 1.11 Carbon monoxide is a colourless and odourless gas. Inhaling this gas can cause death as well as serious long term health problems such as brain damage.
- 1.12 The symptoms of carbon monoxide poisoning can include but are not limited to the following;
Headaches, dizziness, nausea, breathlessness, collapsing or loss of consciousness.
- 1.13 Carbon monoxide poisoning symptoms are similar to flue, food poisoning, viral infections and simply tiredness. It is quite common for people to mistake this very dangerous poisoning for something else.
- 1.14 To avoid carbon monoxide poisoning **DO NOT** use Petrol/Diesel powered equipment inside any of the following; Home, garage, tent, camper van, mobile home, caravan or boat. This is not exhaustive and if you are in any doubt contact your dealer.
- 1.15 If you think you have or someone around you has been affected by carbon monoxide poisoning;
- 1.16 Get them fresh air immediately, by leaving the affected area or by opening doors and windows. If safe and practical to do so make sure that the machine is turned off. **DO NOT** enter a room you suspect of having carbon monoxide present – instead call the emergency services.
- 1.17 Contact a Doctor immediately or go to Hospital – let them know that you suspect carbon monoxide poisoning.
- 1.18 **DO NOT** use in an enclosed area or moving vehicle.

1.20 General Fuel Safety (where applicable).



CAUTION

ALL FUELS ARE FLAMABLE

- 1.21 Fire Hazard – keep fuel away from all sources of ignition for example heaters. Lamps, sparks from grinding or welding.
- 1.22  **DO NOT** carry out hot work on tanks that have contained fuel.
- 1.23 **ALWAYS** keep the work area tidy.
- 1.24 **ALWAYS** clean up spills promptly using absorbent granules and a lidded bin.
- 1.25 **ALWAYS** dispose of waste fuels correctly.

1.30 **Fueling/De-fueling (where applicable).**



CAUTION

ALL FUELS ARE FLAMABLE

1.31 **ALWAYS** fuel and defuel in a well ventilated area outside of buildings.

1.32 **ALWAYS** wear correct, suitable and fit for purpose Personal Protective Equipment (PPE), suggested items are but not limited to safety gloves, overalls.



1.33 When fueling/de-fueling **ALWAYS** avoid inhaling fumes.

1.34 When de-fueling **ALWAYS** use a proper fuel retriever.



1.35 **ALWAYS** carry fuel in the correct and clearly marked container.

1.40 **Electrical Safety (where applicable).**

1.41 Electricity can kill – **NEVER** work on **LIVE/ENERGISED** equipment.

1.42 Prior to carrying out any maintenance work you **MUST** identify electrical isolation methods and isolate all electrical supplies.

1.43 Prior to use and with all electrical supplies isolated, you **MUST** check all electrical cables, plugs and connectors for the following;

1.44 Are intact and have no signs of damage, to include but not limited to bare wires, chaffing, cuts and loose wiring.

1.45 If there are any signs of damage, the damage item **MUST** be taken out of service until the damage has been repaired by an electrically competent person.

1.46 All trailing cables should be routed so as not to cause any kind of trip hazard.

1.47 **NEVER** work on or near electricity with wet hands, wet clothing and wet gloves.



1.50 Batteries (where present).

- 1.51 Batteries present a risk if they become damaged by the possible leaking of electrolyte. This electrolyte is an acid and can cause serious burn injuries. Care should be taken when working on or near them. **NOTE** the electrolyte may be in a liquid or gel form.
- 1.52 Should you come in to contact with electrolyte you should;
- 1.53 Remove all clothing contaminated with electrolyte. If you cannot remove then saturate them in water.
- 1.54 Get medical assistance as soon as possible. You must advise the medical staff of the type of acid.
- 1.55 Lead/acid battery = dilute sulphuric acid.
- 1.56 Nickel/cadmium = potassium hydroxide alkali electrolyte.
- 1.57 Use fresh running water to wash off excess electrolyte, continue this until medical assistance arrives. Make sure that you do not wash the electrolyte to another part of your body or face.
- 1.58 If electrolyte comes in to contact with Eyes the electrolyte needs to be immediately washed away with large amounts of water. Make sure that you do not wash the electrolyte to another part of your face or body.
- 1.59 Gasses from charging batteries are highly flammable and great care should be taken to charge in well ventilated areas.
- 1.59.1  There is an explosion risk if the battery terminals are short circuited, when connecting/disconnecting **ALWAYS** exercise great care so that the terminals or battery leads are **NOT** allowed to touch and cause a spark. **ALWAYS** use suitable insulated tools.

1.60 Vibrations (where applicable).

- 1.61 Prolonged use of hand held (operated) machines will cause the user to feel the effects of/from vibrations. These vibrations can lead to white finger (Raynaud's phenomenon) or carpal tunnel syndrome. This condition reduces the ability of the hand to feel and regulate temperature, causing numbness and heat sensations and may cause nerve damage and circulatory tissue death.
- 1.62 Not all factors that lead to white finger disease are known, but cold weather, smoking and other diseases that affect blood vessels and blood circulation as well as large and long-lasting impact of shocks are considered factors in the formation of white finger. Note the following to reduce the risk of white finger and carpal tunnel syndrome;
- 1.63 Wear gloves and keep your hands warm.
- 1.64 Take regular breaks.
- 1.65 All of the above precautions may help reduce the risk of white finger disease but not rule out the carpal tunnel syndrome. Long-term and regular users are therefore recommended to observe the condition of your hands and fingers. Seek medical attention immediately if any of the above symptoms should occur.

1.70 Noise (where applicable).

- 1.71 The operating noise of the machine can damage your hearing. Wear hearing protection such as earplugs or ear defenders to protect your hearing. Long-term and regular users are advised to have hearing checked regularly. Be especially vigilant and cautious when hearing ear protection because your ability to hear alarm warnings will be reduced.
- 1.72 Noise emissions for this equipment is unavoidable. Carry out noisy work at approved times and for certain periods. Limit the working time to a minimum. For your personal protection and protection of people working nearby it is also advisable for them to wear hearing protection.
- 1.73  See Certificate of Conformity section for Outdoor Noise declaration of conformity.
- 1.74 **DO NOT** use this machine inside a confined space such as but not limited to a vehicle, house, garage, container, boat or building. Only use outside in a well ventilated area.
- 1.75 For air cooling a minimum of 1m is required all around the machine.
- 1.76 Maximum ambient temperature 40 degrees Celsius.
- 1.77 Fire risk- Fuel can expand and overflow in a hot environment or moving vehicle.
- 1.78 Explosion risk- LPG/ Petrol can leak and the vapour is heavier than air. Never store in confined spaces especially in a boat where the vapour/has will accumulate in the hull and create a high risk of explosion.
- 1.79 Carbon monoxide poisoning risk- Never run an engine in a confined space or poorly ventilated area. Keep the machine away from windows to prevent fumes entering the internal space. Carbon monoxide is produced by the engine and contained in the exhaust fumes. You cannot see it or smell it and it can kill you in minutes.
- 1.80 Never use inside a confined space with an exhaust extension. If the exhaust extension fails the escaping exhaust gases could kill you.

2. PART LOCATIONS



1	Drive Control Lever
2	OPC Lever
3	Handle
4	Oil Filler Cap
5	Fuel Filler Cap
6	Spark Plug
7	Primer Bulb
8	Exhaust (caution Hot)
9	Recoil Starter Handle
10	Grass Catcher
11	Wheel Height Adjustment Lever
12	Side Flap

3. QUICK START GUIDE

CAUTION

This guide is meant to serve as a quick reference for operating your Hyundai Lawn Mower.

We always advise reading the manual in full before operation.

CAUTION

For **OUTDOOR** use **ONLY**.

Petrol lawnmowers produce carbon monoxide – a poisonous, colourless and odourless gas that can cause serious injury or death.

Petrol is highly flammable, always handle with extreme care and in a well ventilated area.

NOTE

Images may vary depending on model.

If the lawnmower has the mulching option, **the mulching plug may already be installed for transport.**

GRASS COLLECTION MOWING

- 2.0 Lift the rear cover (1).
- 2.1 Remove the mulch plug if fitted (2).
- 2.2 Attach the grass catching bag (3).

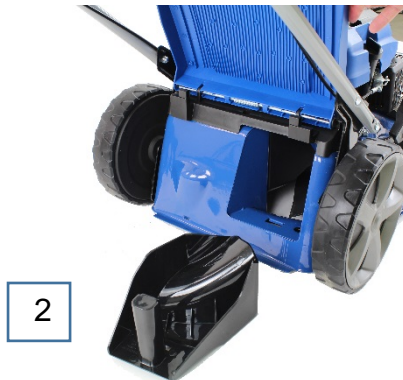

- 2.3 Attach the base of the handle to the mower (4) and tighten hand wheel (5) securely.
- 2.4 Attach the upper handle to the lower handle (6) and tighten the hand wheel securely.
- 2.5 Slowly pull the recoil cord and thread it through the cord loop (7).

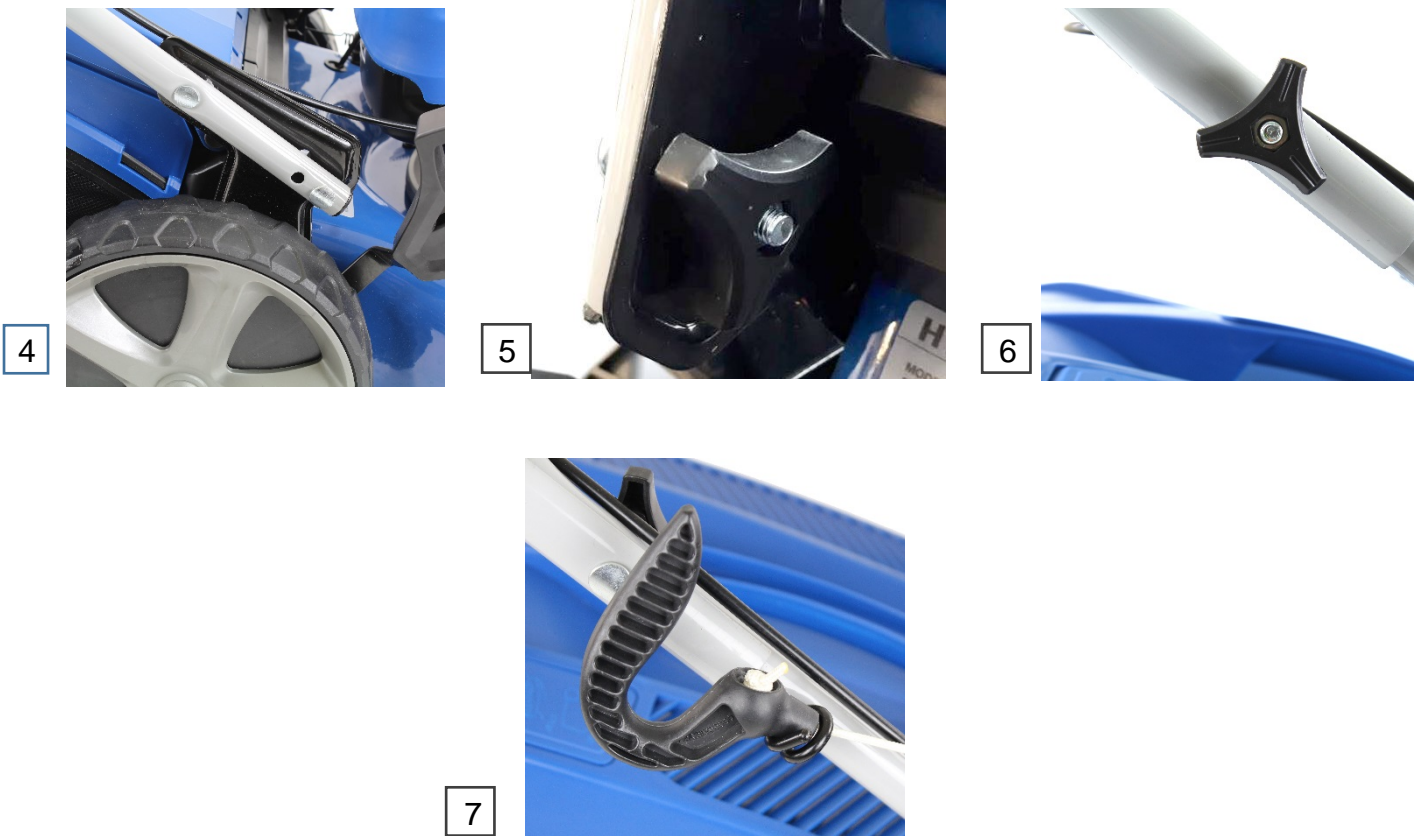

- 2.6 Remove the oil filler cap (8) and fill with fresh 15W-40 engine oil to the upper mark (9) on the dipstick. **DO NOT** overfill.
- 2.7 Once the correct amount of oil has been added, refit the dipstick securely.
- 2.8 If you overfill the oil, you can remove some by gently tilting the machine on its side and pouring out any excess oil into a suitable container.

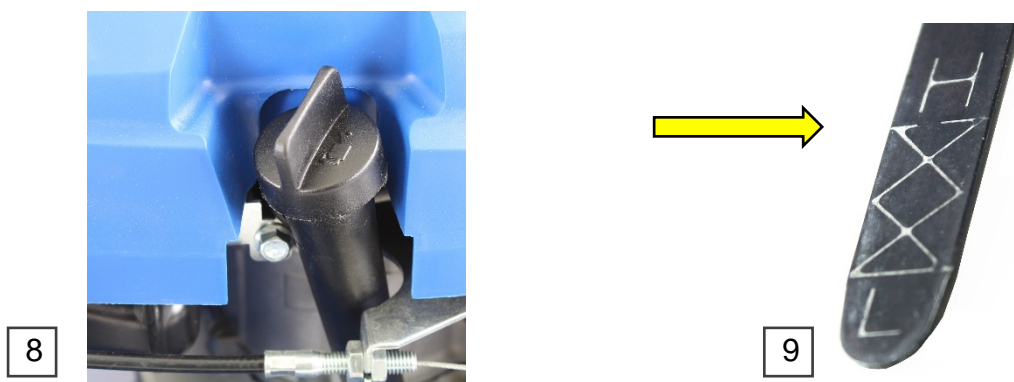

- 2.9 Remove the fuel tank cap (10).
- 2.10 Fill the fuel tank with fresh straight unleaded petrol. Allow a 25mm gap from the top of the tank, then refit the cap securely.
- 2.11 **DO NOT** mix petrol with oil and clean up any spills immediately.

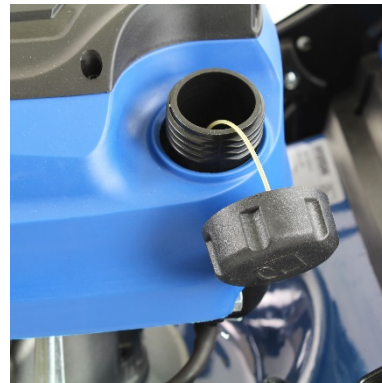

MULCHING MODE

- 2.12 For mulching mode, lift the rear flap and remove the grass box (1).
- 2.13 Install the mulching plug and lower the rear cover (2).



SIDE DISCHARGE

- 2.14 Carry out the steps in 2.12 & 2.13.
- 2.15 Push the catch (1) on the side discharge flap and lift the side flap (2).



2.16 Hook the side discharge chute on to the metal bar underneath the side flap (3).

2.17 Allow the spring loaded side flap to rest on the discharge chute (4).

3

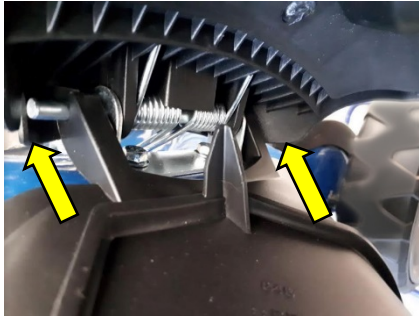

4



REAR DISCHARGE

2.18 Remove the grass bag and mulching plug (if installed).

2.19 Using the two plastic tabs (1) provided, locate the two slots underneath the rear discharge flap.

1



2



2.20 Insert the two tabs in to the slots (3) and lower the rear discharge flap on to them (4). This raises the rear discharge flap and stops the rear discharge chute from becoming blocked.

3

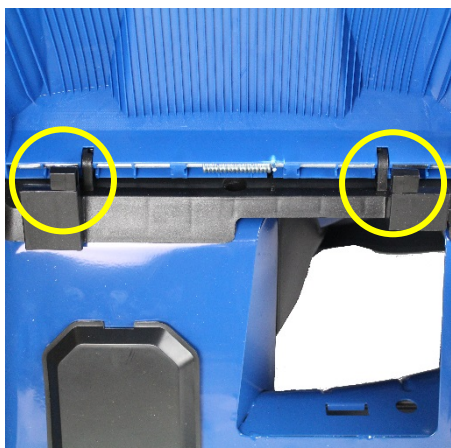

4



ADJUSTING THE OPC LEVER

NOTE

Before use you **MUST** check and if necessary adjust the Operator Presence Control cable (OPC). If it is too loose the lawn mower will not start.

To locate the adjuster follow the cable from the OPC handle to the engine body where you will see the OPC adjuster.

- 2.18 If the OPC cable is too loose you will need to tighten it.
- 2.19 Undo the locknut (anticlockwise) and turn the adjuster nut in a clockwise direction.
- 2.20 Attempt to start the mower and if adjusted correctly the lawnmower will start.
- 2.21 Tighten the locknut.

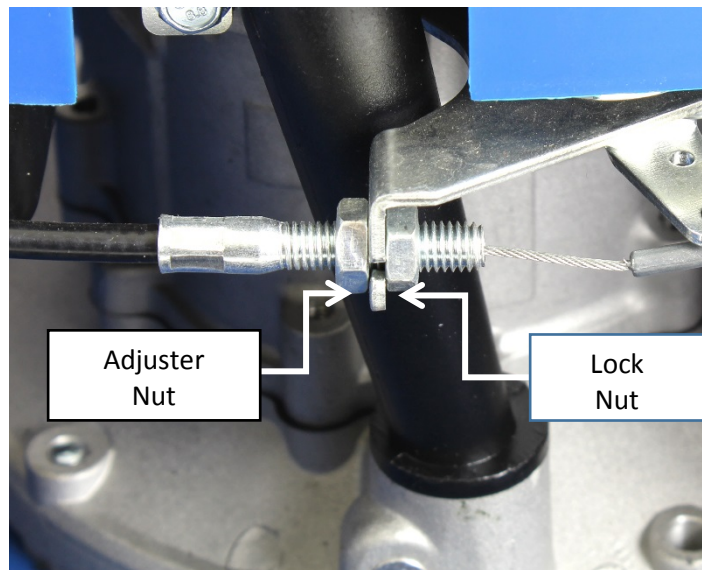

4. STARTING PROCEDURE

NOTE

You **MUST** ensure the mower has the correct oil and fuel level before operation.

- 3.0 From cold, pump the primer bulb (1) 5 times.
- 3.1 Make sure the blade is free of long grass and the cutting height is set to maximum (2).



1

2

3.2 Pull back the Operator Presence Control (OPC) lever (3) towards the main handle.

3.3 Pull the recoil starter handle (4) swiftly – repeat until the engine starts.

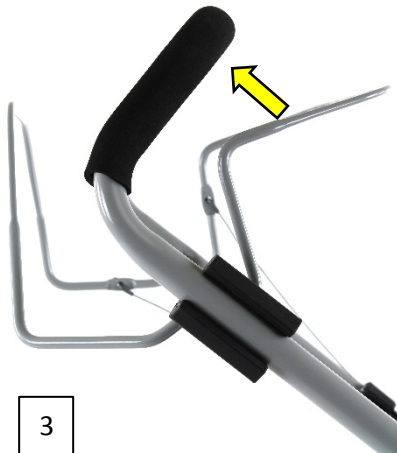

5. STOPPING PROCEDURE



CAUTION

The engine and exhaust will remain hot for a while after use. Ensure the engine and exhaust have cooled before carrying out any maintenance or storage.

4.0 Before stopping the machine, you must allow the engine to idle for 30 seconds.

4.1 Release the OPC Lever (1) and the engine will stop.

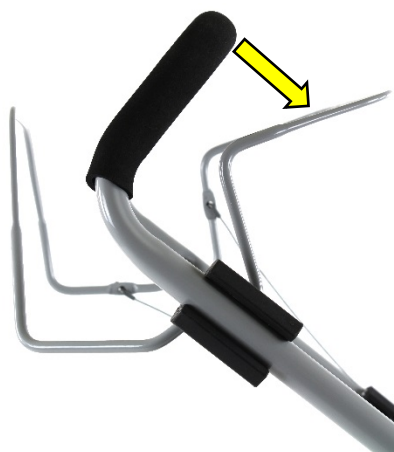

6. USING THE MACHINE

- 5.0 Always use the lawnmower with the grass catcher, or rear deflector in position.
- 5.1 Stop the engine before emptying the grass catcher or before you change the cutting height.
- 5.2 Never put feet or hands near the mower when running.
- 5.3 Before mowing, remove all foreign objects from the lawn, which may cause injury or damage.
- 5.4 Keep children, people and pets at a safe distance (at least 20m) when the lawnmower is in use.
- 5.5 Always wear appropriate Personal Protective Equipment (PPE) when using this machine. Suggested PPE: Sturdy footwear, work gloves (especially when working near blade), long trousers and hearing protection.
- 5.6 Never work barefooted or with open shoes or sandals.
- 5.7 Do not operate the engine in a confined space where dangerous carbon monoxide fumes can collect.
- 5.8 Mow only in daylight.
- 5.9 Avoid operating the equipment in wet grass.
- 5.10 Always be sure of your footing on slopes **WALK**, never run.
- 5.11 For wheeled rotary machines, mow across the face of slopes, never up and down. Exercise extreme caution when changing direction on slopes.
- 5.12 Do not mow excessively steep slopes.
- 5.13 Use extreme caution when reversing or pulling the lawn mower towards you, in case you slip and your feet go underneath the machine and in to the blade.
- 5.14 Stop the engine and allow the blade to come to a stop if the lawn mower has to be tilted for transportation when crossing surfaces other than grass, and when transporting the lawn mower to and from the area to be mowed.
- 5.15 Never operate the lawn mower with defective guards, or without safety devices, for example deflectors and/or grass catchers, in place.

- 5.16 Do not change the engine governor settings. If the engine speed is too high it will cause excessive wear, if too low it will not cut or pick up the grass effectively.
- 5.17 Engage all blade and drive clutches before starting the engine.
- 5.18 Start the engine carefully according to instructions and with feet well away from the blade.
- 5.19 Do not tilt the lawn mower when starting the engine.
- 5.20 Do not put hands or feet near or under rotating parts.
- 5.21 Never pick up or carry a lawn mower while the engine is running.
- 5.22 Before leaving the mower to clear blockages, check, clean, refuel or after striking foreign object - Stop the engine and disconnect the spark plug cap, make sure that the blades have come to a complete stop.
- 5.23 If the lawn mower starts to vibrate abnormally (check immediately).

7. MAINTENANCE



WARNING

NEVER touch a rotating blade.

Always stop the engine and unplug the spark plug before doing any repairs or maintenance.

Check regularly the oil level and keep it to the recommended level as required.

Frequently check the lawnmower and ensure that all grass deposits are removed from beneath the deck.

Lubricate the wheel bearings with a suitable lubricant.

Check the blade, in order to obtain a good cut, the blade should always be sharp and well balanced. At regular intervals, check the tightness of all nuts, bolts and screws.

If the blade hits an obstacle check for damage and if the machine vibrates badly stop the lawnmower and take it to a service dealer.



CAUTION

Always refuel in a well-ventilated area with the engine off.

Whilst carrying out maintenance you must wear appropriate Personal Protective Equipment (PPE) when using this machine.

Suggested PPE Sturdy footwear, work gloves (especially when working near blade), long trousers and hearing protection.

THE BLADE

- 6.0 The blade. You **MUST** wear gloves to protect your hands from being cut when working with the blade.
- 6.1 The blade is made of pressed steel, in order to obtain a good cut sharpen the blade frequently typically around every 25 hours of work.
- 6.2 Following blade sharpening you must make sure that the blade is always well balanced.
- 6.3 To remove the blade, unscrew the bolt, check the blade support and change all spare parts if they are worn out or damaged.

THE SPARK PLUG

- 6.4 You **MUST** allow the spark plug to cool down before carrying out any maintenance.
- 6.5 Always replace with the same model spark plug as fitted.
- 6.6 To check spark plug, remove spark plug cap (1) and remove spark plug using a spark plug wrench (not provided) (2).

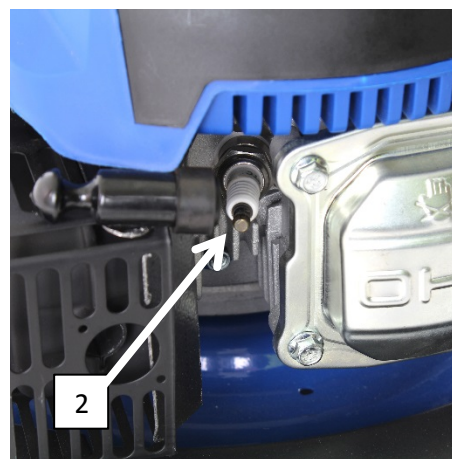
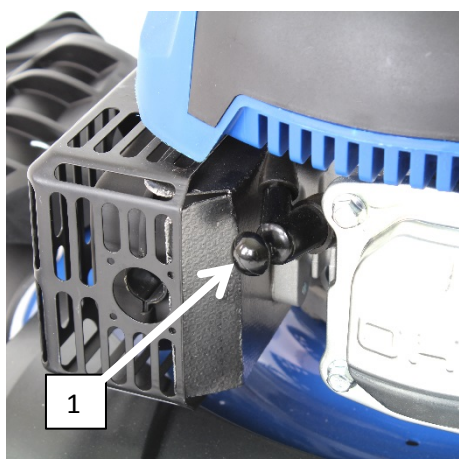

- 6.7 Clean the spark plug electrode, making sure that there is no damage to the insulator or electrode.
- 6.8 The spark plug gap should be 0.70mm to 0.80mm adjust as necessary by carefully bending the side electrode.

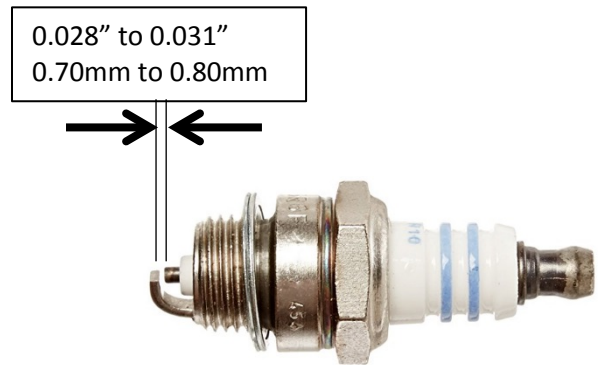

- 6.9 Refit the cleaned and adjusted spark plug by hand to avoid cross-threading.
- 6.10 After spark plug seats then tighten as necessary but avoid over-tightening.
- 6.11 Re-attach the spark plug cap.

AIR FILTER



CAUTION

A dirty air filter will restrict the air flow to the carburetor, which will reduce engine efficiency.

When using the lawnmower in very dusty areas you must clean or replace the air filter more often.

Never operate machine without the air filter being fitted it can cause damage to the engine which is not covered by warranty.

- 6.12 To gain access to the air filter press the latch tabs (1).
- 6.13 Remove filter (2), check for contamination and clean or replace as required.

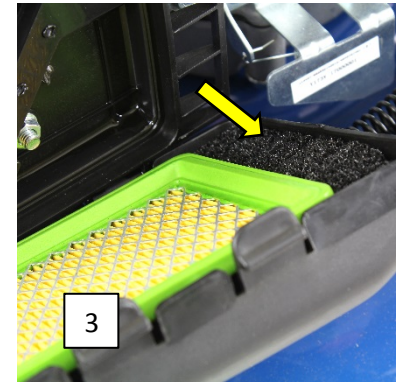
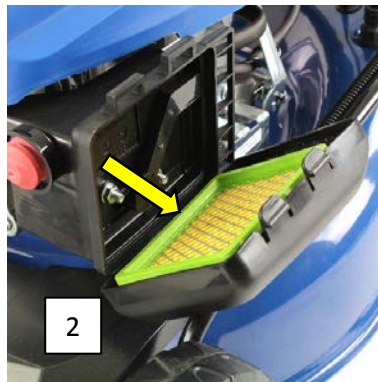

- 6.14 Clean the filter by blowing air through it using an air gun not exceeding 30psi.
- 6.15 Also clean the foam pre-filter (3). Wash in detergent and let dry.
- 6.16 Never use a brush to clean the filter it will only drive dirt into the fibres of the filter.
- 6.17 Wipe dirt from the air cleaner body by using a moist rag, be careful to prevent dirt or debris entering in to the carburetor.

FUEL AND CARBURETOR



CAUTION

ALL FUELS ARE FLAMABLE

ALWAYS fuel and defuel in a well ventilated area outside of buildings.

ALWAYS wear correct, suitable and fit for purpose Personal Protective Equipment (PPE), suggested items are but not limited to safety gloves, overalls.

- 6.18 The use of old or stale fuel will impair starting and running of the machine.
- 6.19 Make sure that the machine has fresh unleaded fuel and always remove fuel before storing for long periods.
- 6.20 Never mix fuel and oil.

- 6.21 To drain the carburetor float bowl (1) undo the drain bolt making sure that the washer is not lost.
- 6.22 Use a suitable container to catch fuel. Take care not to spill fuel and make sure that all spilt fuel is cleared away safely.

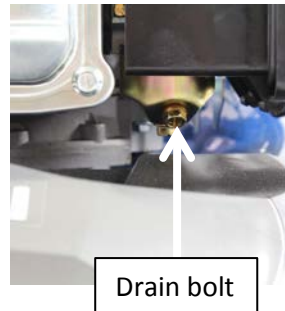

DRIVE BELT

- 6.23 Remove the access panel (1) at the rear of the mower to inspect the drive belt tension and condition.



CLEANING



CAUTION

DO NOT use a hose pipe or pressure washer to clean the engine. Water can damage the engine or contaminate the fuel system.

- 6.23 Wipe the deck with a dry cloth.
- 6.24 You can hose under deck by tilting the mower. Make sure you tilt the machine so that the air filter is facing up. NOTE Engine must be switched off and plug lead disconnected.
- 6.25 Dry the machine completely to prevent any rust forming. You can use a light oil or silicone spray to prevent rust.

STORAGE



NOTE

When storing the machine, make sure it has been cleaned as in section 6.23. You can use a light oil or silicone spray to coat the equipment.

- 6.26 The following steps should be taken to prepare your lawnmower for storage.
- 6.27 After the final cut of the season – you must drain the fuel from the fuel tank. Then run the machine until the engine comes to a stop this allows the carburetor to be emptied of fuel.
- 6.28 Clean the mower completely and make sure all moving parts are lubricated.
- 6.29 Check the blade to make sure that it is ready for the following season – This will allow you to get it sharpened correctly. Use a light oil or silicone spray to help prevent the blade from rusting.
- 6.30 Once all work above is carried out store the machine in a clean and dry place. **DO NOT** store a machine that has not been given time to fully cool down.

8. TROUBLE SHOOTING



NOTE

Where necessary, all corrective actions should be carried out by suitably qualified persons.

- 7.0 If the starter rope becomes disconnected from the rope guide on handle, disconnect the spark plug cap.
Pull the starter rope out from engine slowly and re-engage in guide. Re connect spark plug cap.

Problem	Possible Cause	Possible Corrective Action
	OPC cable not adjusted correctly	Adjust OPC cable
	Fuel tank is empty	Fill fuel tank
	Stale fuel	Drain carburetor float bowl

Engine does not start	Air filter element is dirty	Clean or replace air filter
	Spark plug is loose	Tighten spark plug
	Spark plug cap loose or disconnected	Correctly fit the spark plug cap
Spark plug faulty	Spark plug gap is incorrect	Set plug gap to 0.7 – 0.8mm or Replace spark plug
	Carburetor is flooded with fuel	Remove the air filter and pull starter rope until carburetor clears
	Faulty ignition module	Contact the service dealer
Engine difficult to start or loses power	Dirt, water or stale fuel in tank	Drain fuel and clean tank Fill with clean, fresh fuel
	Vent hole in fuel tank is clogged	Clean or replace fuel tank cap
	Air filter element is dirty	Clean or replace air filter element
Engine operates erratically	Spark plug is defective	Fit new, correctly gapped spark plug
	Spark plug gap is incorrect	Set plug to 0.7 – 0.8mm
	Air filter element is dirty	Clean or replace air filter element
Engine idles poorly	Air filter element is dirty	Clean or replace air filter element
	Air slots in engine are blocked	Remove debris from slots
	Cooling fins and air passages under engine housing are blocked	Remove debris from cooling fins and passages
Engine skips at high speed	Spark plug electrode gap is incorrect	Set plug gap to 0.7 – 0.8mm
Engine Overheating	Cooling airflow is restricted	Remove any debris from slots in shroud, blower housing, air passages
	Incorrect spark plug	Fit new spark plug
Mower vibrates abnormally DO NOT use the machine until vibration issue has been fixed	Cutting assembly is loose	Tighten blade
	Blade/cutting assembly is unbalanced	Take to a service dealer

9. SPECIFICATION

MODEL	HYM430SP HYM43SP-2	HYM460SP HYM46SP	HYM510SP HYM51SP
Engine Type	IC140V	IC140V	IC175V
Engine Size – cc	139	139	173
Fuel Tank Capacity - L	1	1	1
Fuel Type	Unleaded Petrol		
Oil Capacity – ml	600	600	600
Rated Speed – rpm	3000	3000	3000
Rated Power – kw	2.6	2.6	3.6

Drive Type	Self-propelled	Self-propelled 4 in 1	Self-propelled 4 in 1
Start Method	Recoil Start		
Height Adjustment	6 position		
Cutting Height - mm	25-75mm		
Cutting Width – mm	420	460	510
Catcher Type	Half Plastic with polyester bag		
Catcher Volume	45	70	70
Deck Material	Steel		
Wheel Size Front – mm	150	180	200
Wheel Size Rear – mm	180	250	280
Handle Type	Soft Grip Handle		
Function	Rear discharge Mulching Collect	Rear discharge Mulching Side discharge Collect	Rear discharge Mulching Side discharge Collect



NOTE

All machines are pre delivery inspected so there may be some residual oil left in the machine so please fill with caution.

10. RECYCLING & PRODUCT DISPOSAL

- 8.0 We do not offer a takeback scheme for the recovery of Waste Electrical Electronic Equipment (WEEE) & Batteries. Instead the responsibility to dispose of WEEE and or Batteries is passed onto you by us. So when it becomes necessary to dispose of your machine you must take it to your local Civic Amenity Site. For further information please contact your local Authority for disposal advice.
- 8.1 You **MUST** make sure that all unused oil and fuel is disposed of correctly either beforehand or at your local Civic Amenity Site. Under NO circumstances must any fuel or oil be put down any drains.

- 8.2 Certain products contain WEEE waste which should not be disposed of in your domestic waste.
- 8.3 You **MUST** recycle WEEE in accordance with your local authority or recycling centre.
- 8.4 Certain products contain batteries which should not be disposed of in your domestic waste.
- 8.5 You **MUST** recycle batteries in accordance with your local authority or recycling centre.
- 8.6 Unwanted packaging and materials should be stored and taken to a recycling centre so it can be disposed of in a manner which is compatible with the environment.
- 8.7 The following symbol means that you should 'Reduce – Reuse – Recycle'.
- 8.8 We are a Member of the VALPAK National Compliance Scheme and our registration number is **RM08660**
- 8.9 For further information about disposal please contact your Local Authority.
- 8.10 You can also get more advice and guidance about recycling at the following website <http://www.recycle-more.co.uk>
- 8.11 Should you pass this product on to another user either sold or loaned, you **MUST** pass on this user manual.
This will make sure that all other users can use and maintain this machine safely.

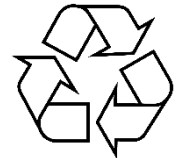
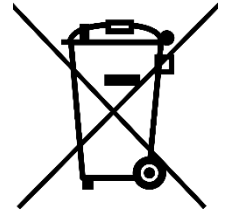

11. DECLARATION OF CONFORMITY

Genpower Ltd confirms that these Hyundai products conform to the following CE Directives.

2006/42/EC Machinery Directive

2004/108/EC EMC Directive

2000/14/EC, Amended by 2005/88/EC Noise Emissions Directive

97/68/EC_2010/26/EC NRMM Emissions Directive

EC DECLARATION OF CONFORMITY

The undersigned. As authorised by:

Genpower Ltd

Declares that the following equipment manufactured under licence by Hyundai Korea

Conforms to the Directive:-
2000/14/EC (as amended)

Of the European Parliament and of the council on the approximation of the laws of the Member States relating to the noise emission in the environment by equipment for the use outdoors.

Equipment Category: **Garden Machinery**

Product Name/Model: **HYM430SP / HYM43SP-2
HYM460SP / HYM46SP-2
HYM510SP / HYM51SP-2**

Type/Serial No: **Lawn Mower**

Net installed power: **HYM430SP / HYM43SP-2 2.6kW
HYM460SP / HYM46SP-2 2.6kW
HYM510SP / HYM51SP-2 3.6kW**

The technical documentation is kept by: **Roland Llewellyn, Genpower Ltd
Isaac Way, Pembroke Dock,
Pembrokeshire, SA72 4RW.**

The conformity assessment procedure followed was in accordance with annex V of the Directive.

Notified Body: **TüV SüV Product Service GmbH
Zertifizierstelle, Riddlerstraße, 65
80339 MÜNCHEN, Germany.
Certification n° M8A 13 07 84794001**

Measured Sound Power Level: **HYM430SP / HYM43SP-2 96dB
HYM460SP / HYM46SP-2 96dB
HYM510SP / HYM51SP-2 98dB**

Guaranteed Sound Power Level: **HYM430SP / HYM43SP-2 96dB
HYM460SP / HYM46SP-2 96dB
HYM510SP / HYM51SP-2 98 dB**

A copy of this certificate has been submitted to the European Commission and the EU Member State United Kingdom.

Place of Declaration: **Pembroke Dock, SA73 4RW**
Date: **07/03/2018**
Signed by: **Roland Llewellyn**



Position in Company: **Managing Director**
Name and address of manufacturer or Authorised representative:
**Genpower Ltd
Isaac Way, Pembroke Dock,
Pembrokeshire, SA72 4RW**

12. CONTACT DETAILS

9.0	POSTAL ADDRESS	Genpower Ltd, Isaac Way, London Road, Pembroke Dock, Pembrokeshire. SA72 4RW. UK.
9.1	TELEPHONE	+44 (0) 1646 687880
9.2	FAX	+44 (0) 0164 686198
9.3	TECHNICAL EMAIL	aftersales@genpower.co.uk
9.4	WEBSITE	www.hyundaipowerequipment.co.uk

MANUAL UPDATES

- 10.0 Our manuals are constantly being reviewed and updated. However if you find an error, omission or something you find unclear, please contact your dealer for assistance.
- 10.1 Our latest manuals are also placed online.
- 10.2 We reserve the right to make any modifications without prior notice whenever necessary.

NOTES

HYUNDAI
POWER PRODUCTS