

A

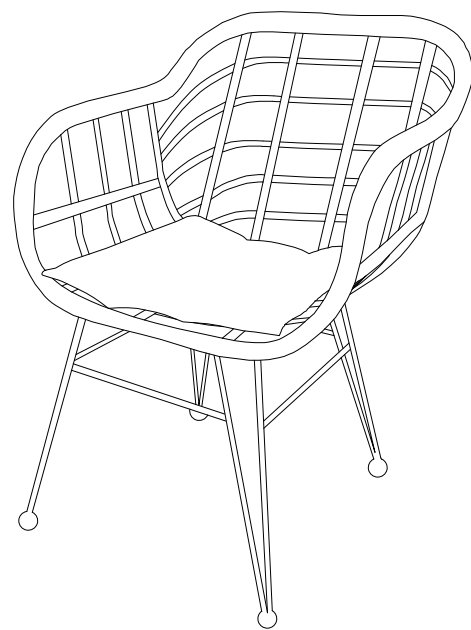

A



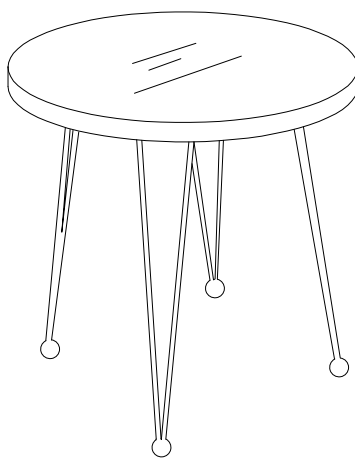

B

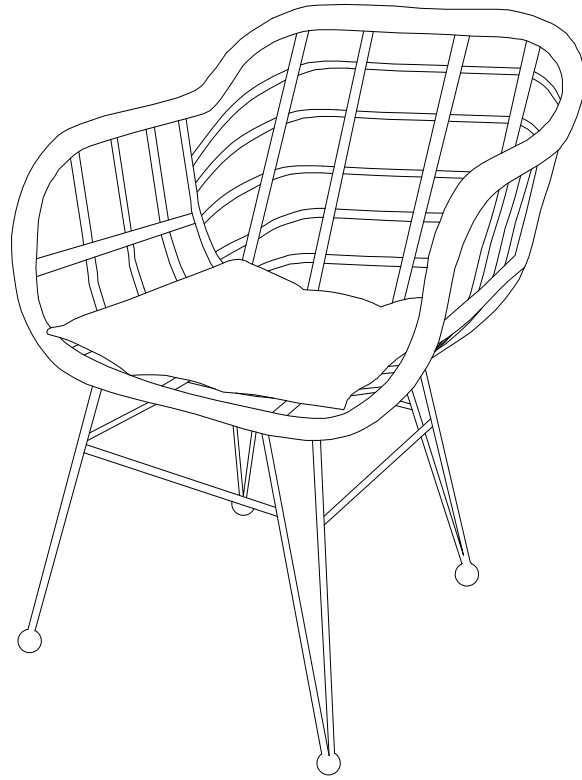

# A x 2

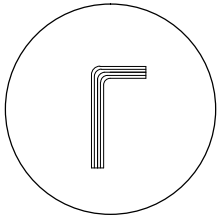
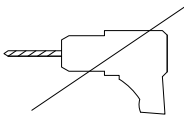
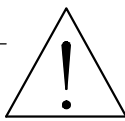
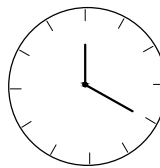
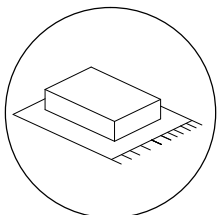
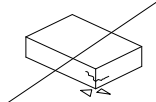
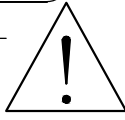

|   |   |   |
|---|---|---|
|   |  |  |
|   |   | <b>20'</b>  |
|   |  |  |
|   |   | <b>1</b>  |

A

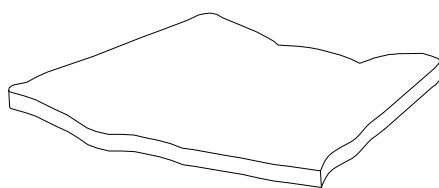

B

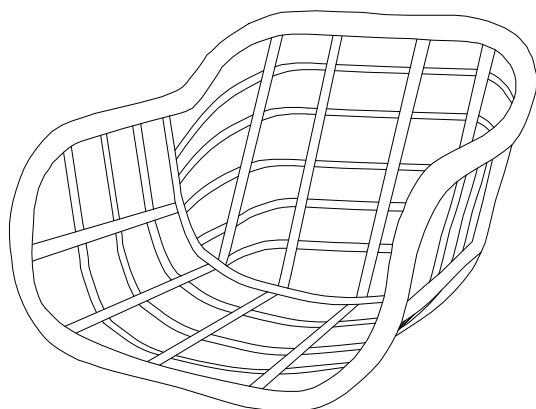

C

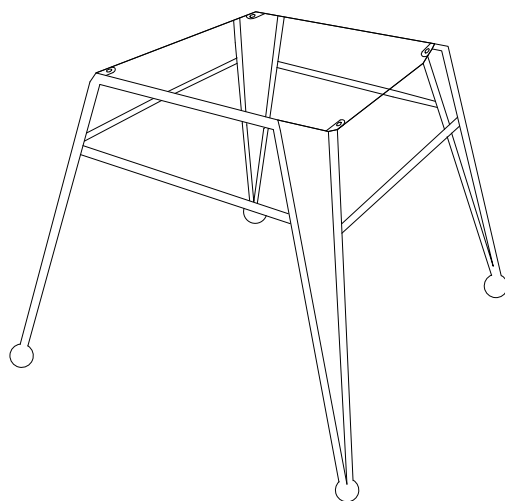

A



x 1

B

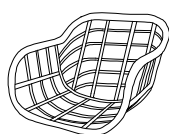

x 1

C



x 1

D

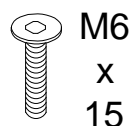

x 4

E

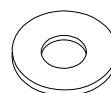



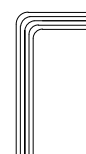

x 4

F



x 1

1

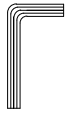
|  |  |   |  |  |
|--|--|---|--|--|
| <b>B</b><br><br>x 1 | <b>C</b><br><br>x 1 | <b>D</b><br>M6<br>x<br>15<br><br>x 4 | <b>E</b><br><br>x 4 | <b>F</b><br><br>x 1 |
|--|--|---|--|--|

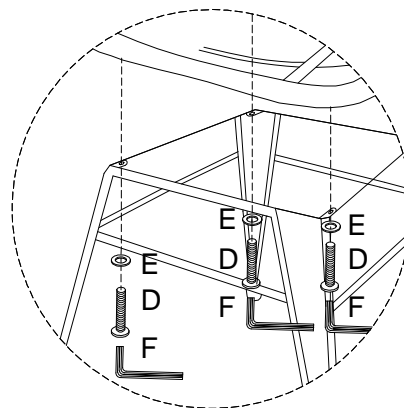
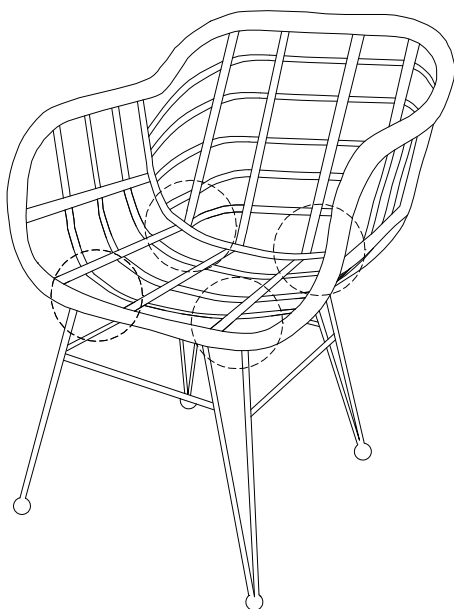

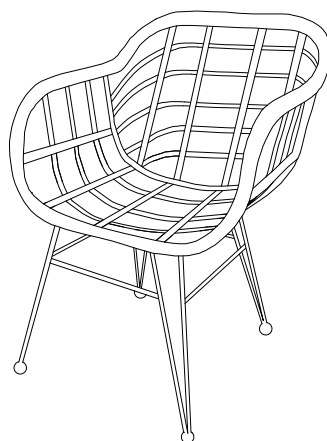

2

**A**  
  
x 1

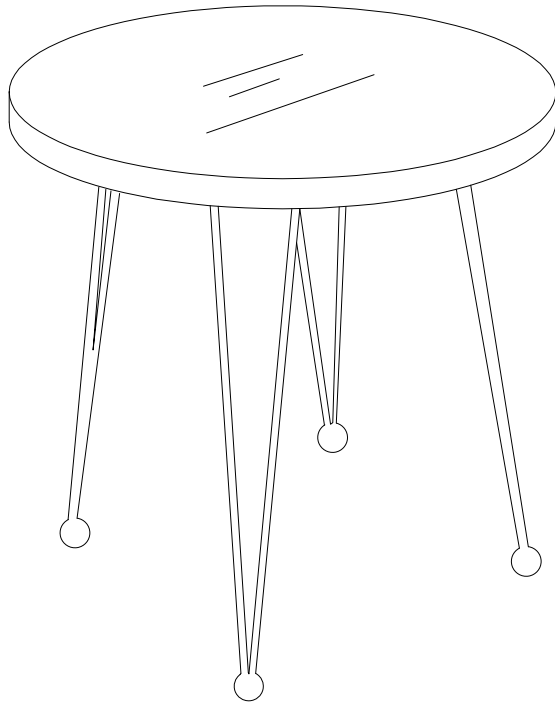

# B

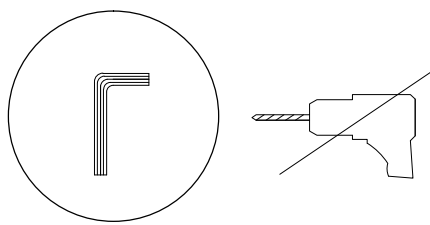
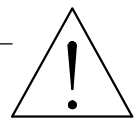
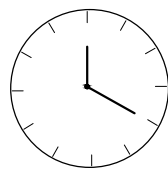
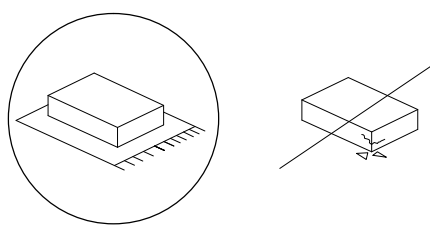

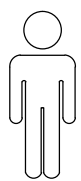
|   |   |   |
|---|---|---|
|  |  |  |
|   |   | <p>20'</p>  |
|  |  |  |
|   |   | <p>1</p>  |

A

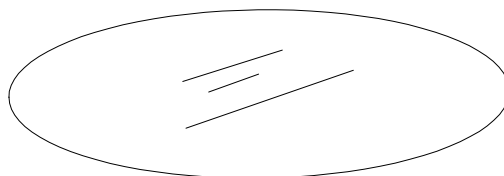

B

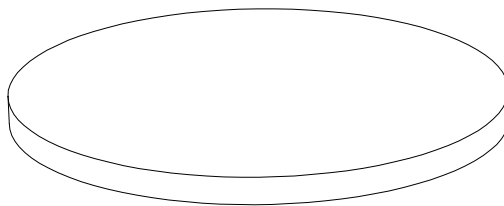

C

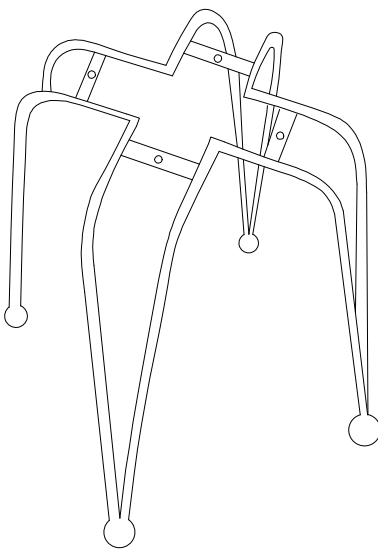

| A   | B   | C   | D  | E   | F   |
|-----|-----|-----|--|-----|-----|
|     |     |     | <p data-bbox="906 1890 962 2007">M6<br/>x<br/>15</p> |     |     |
| x 1 | x 1 | x 1 | x 6  | x 6 | x 1 |

1

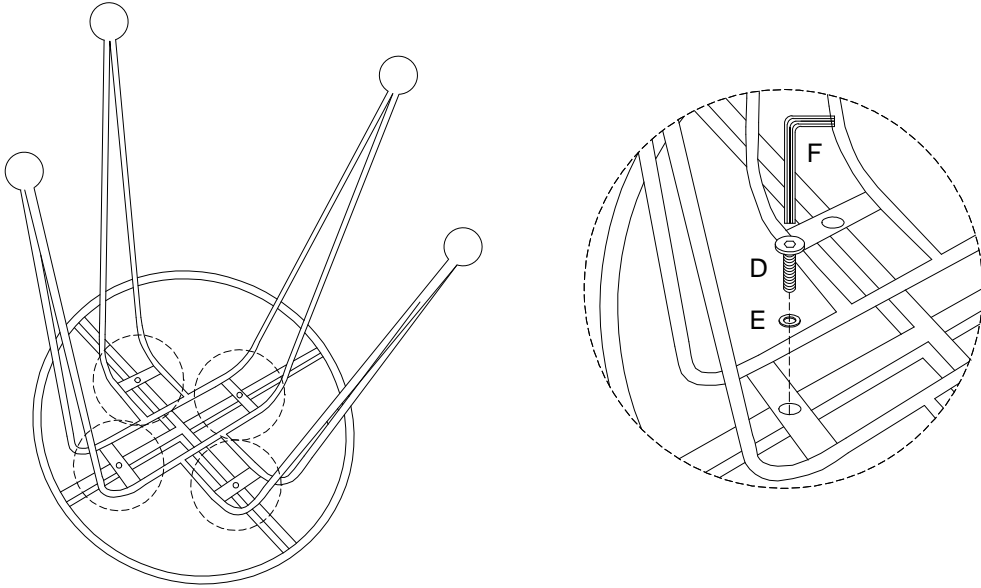
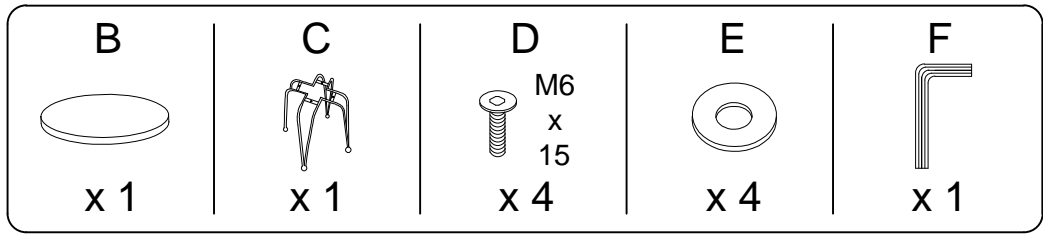

2

