

**PARMA 80
200X80CM**

**PARMA 90
200X90CM**

**PARMA 120
200X120CM**

**PARMA 140
200X140CM**

**FAC233,FAC238,FAC243,FAC247
www.aurlane.com**

VERSION 2

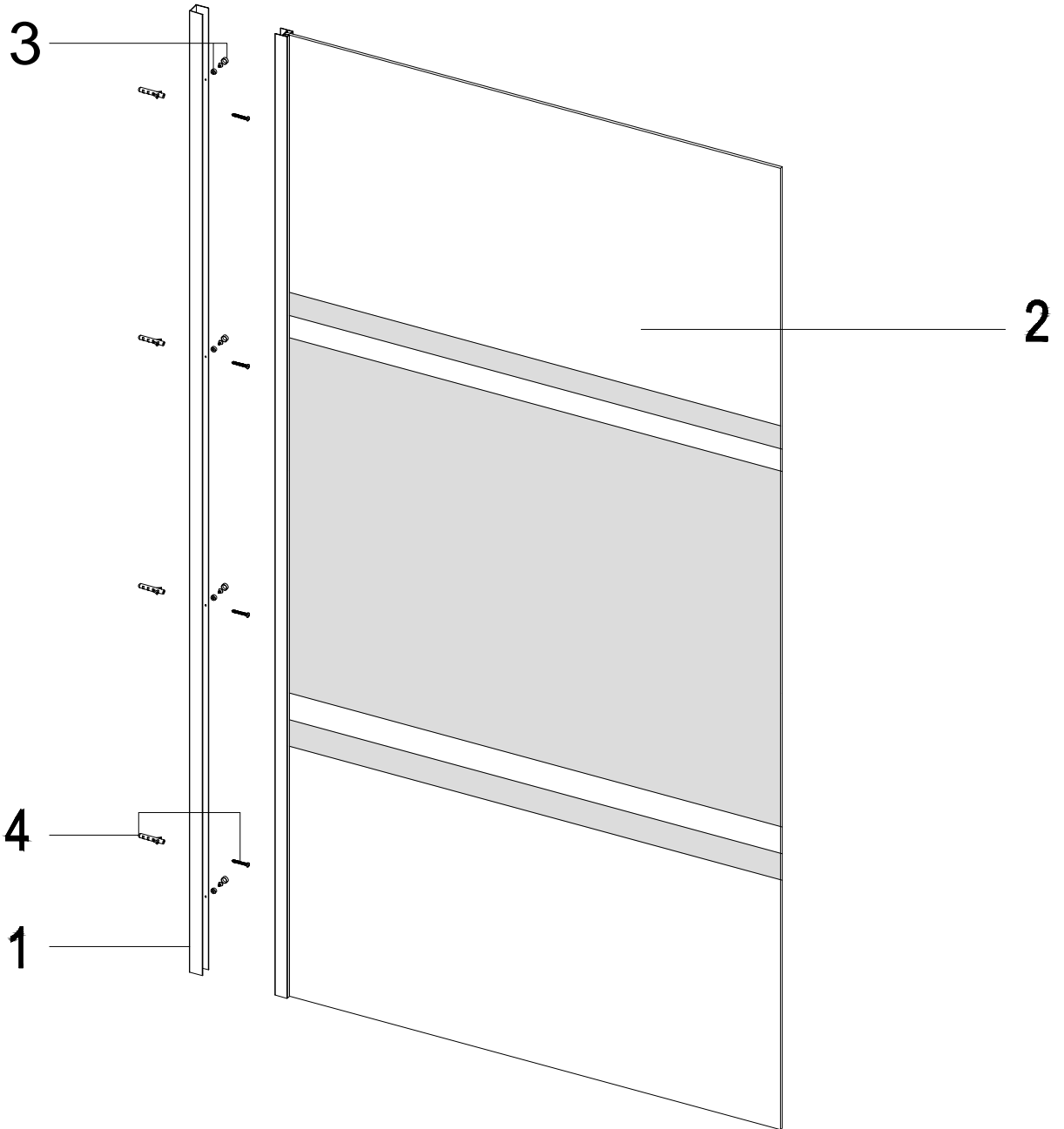

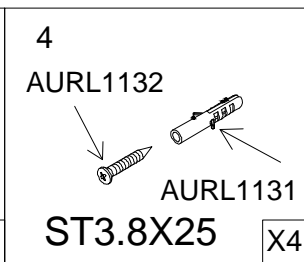
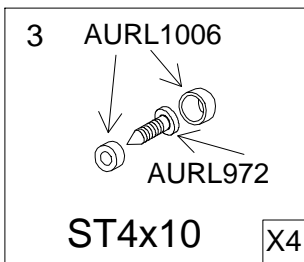
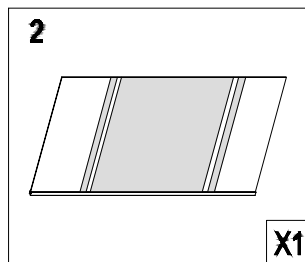
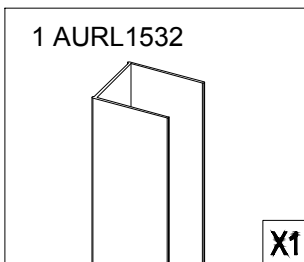
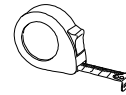
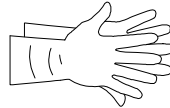
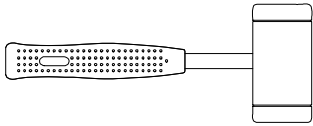
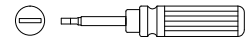
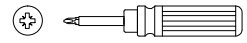
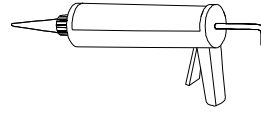
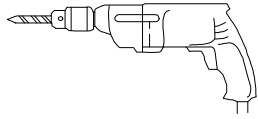
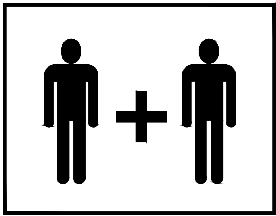

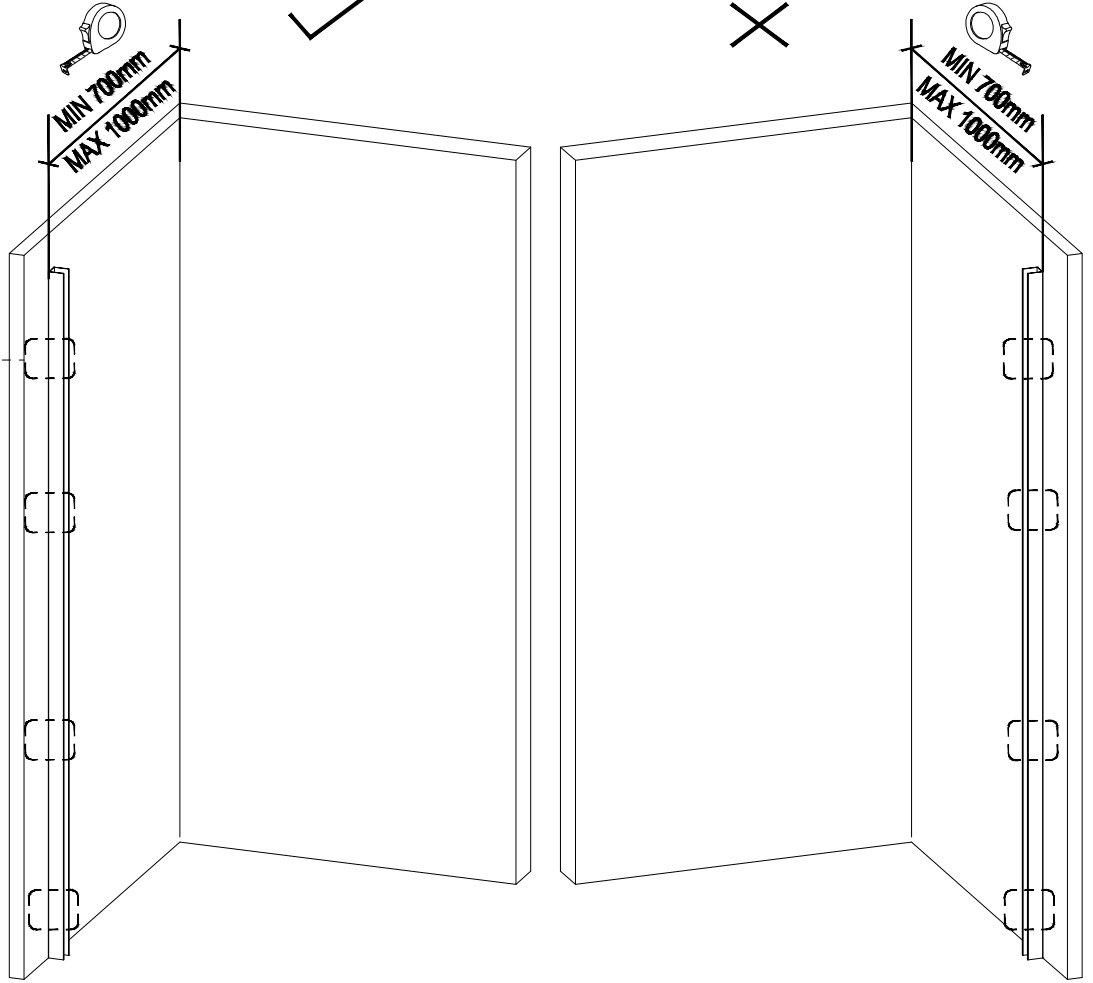
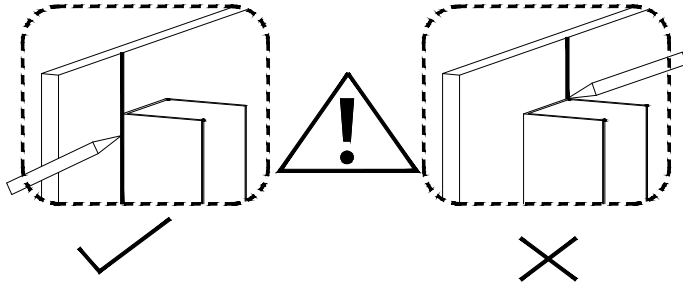
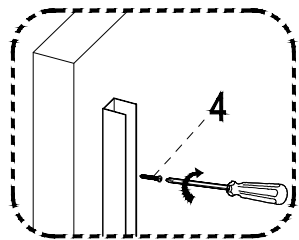
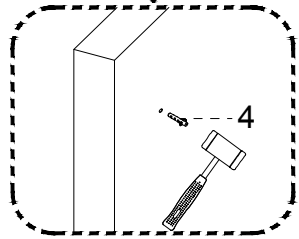
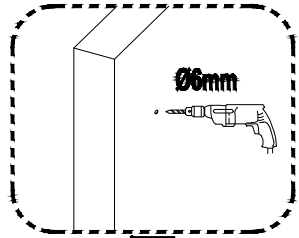
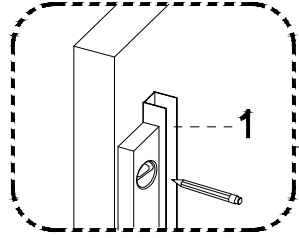
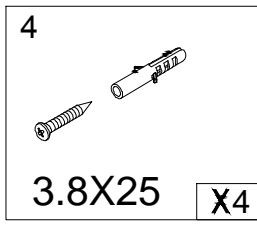
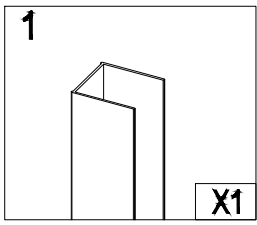

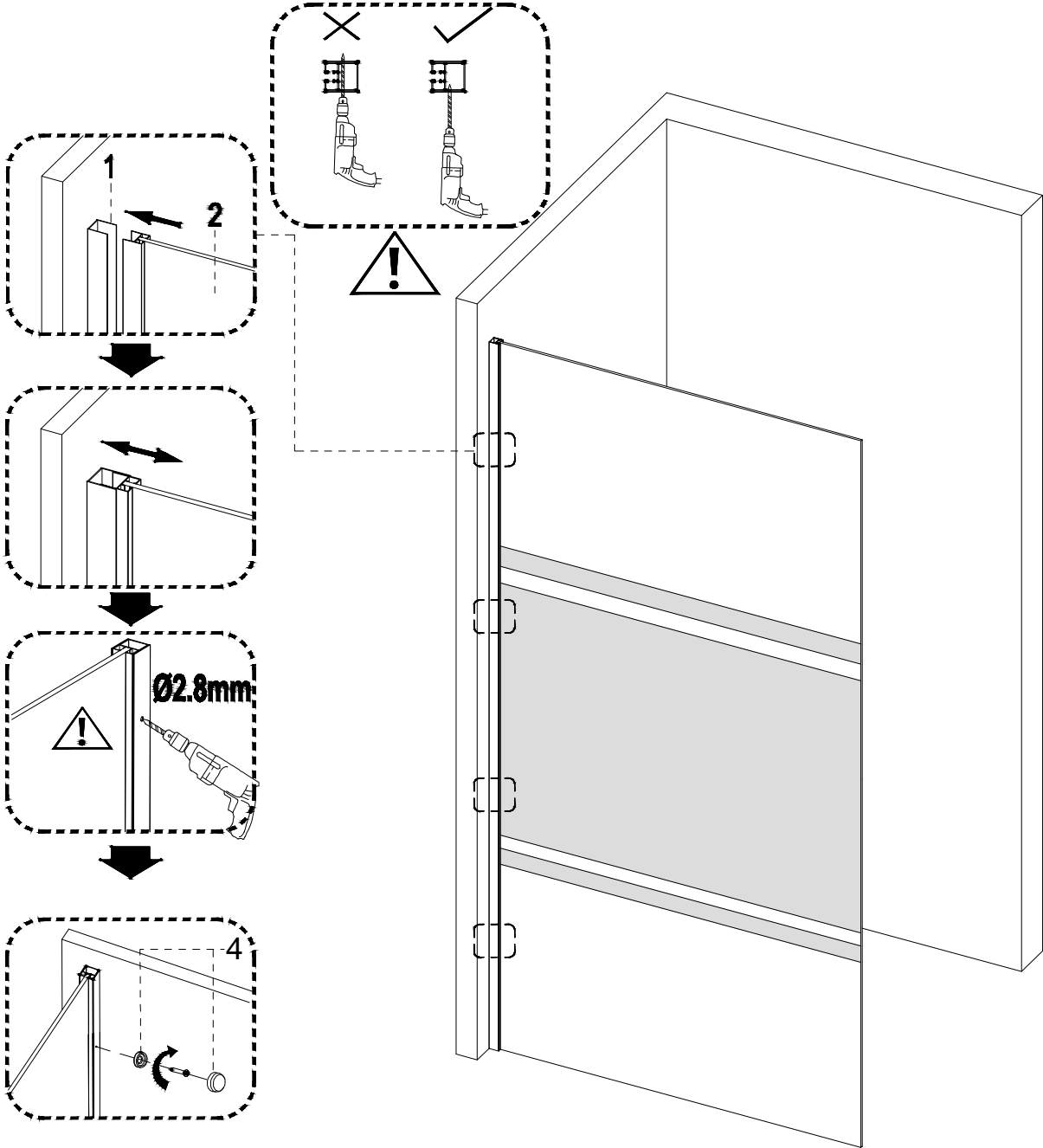
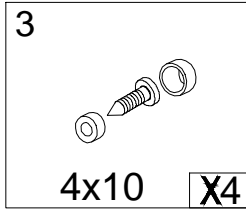
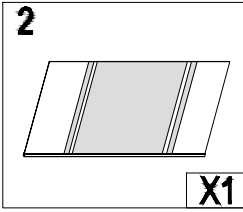

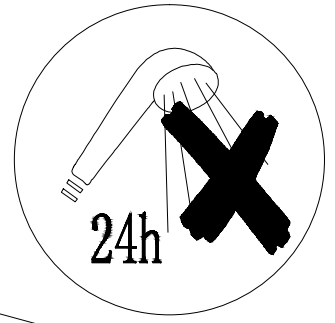
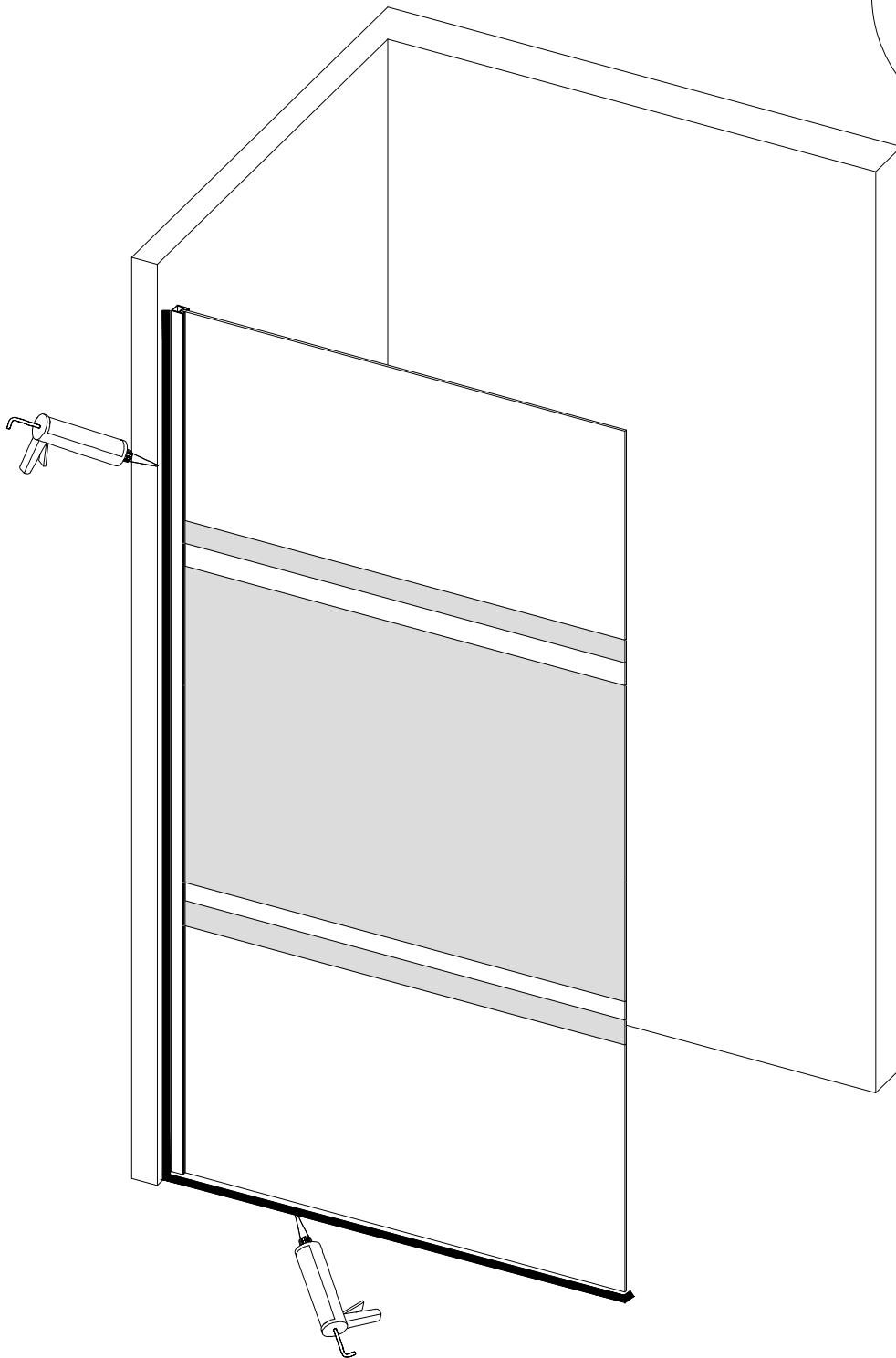

DÉCLARATION DES PERFORMANCES

No DoP_FAC_011

1. Code d'identification du produit Type : PARMA

Par extension, la présente déclaration des performances est applicable aux produits détaillés en annexe.

2. Usage(s) prévu(s) : PAROIS DE DOUCHE POUR HYGIENE PERSONNEL-PH.....

3. Fabricant :AURLANE 32 rue Washington 75008 PARIS.....

4. Mandataire :Non applicable.....

5. Système(s) d'évaluation et de vérification de la constance des performances: système 4.....

6a. Norme harmonisée: EN14428:2004

Organisme(s) notifié(s) : Non applicable

6b. Document d'évaluation européen Non applicable

Evaluation technique européenne Non applicable

Organisme d'évaluation technique Non applicable

Organisme(s) notifié(s) Non applicable

7. Performances déclarées

Caractéristiques essentielles	Performances	Spécifications techniques harmonisées
Aptitude au nettoyage	Exigences satisfaites	EN14428:2004+A1:2008 Clause 4.2
Résistance à l'impact / Propriétés d'éclatement	Exigences satisfaites	EN14428:2004+A1:2008 Clause 4.3
Durabilité	Exigences satisfaites	EN14428:2004+A1:2008 Clause 4.4

Les performances du produit identifié ci-dessus sont conformes aux performances déclarées.

Conformément au règlement (UE) n°305/2011, la présente déclaration des performances est établie sous la seule responsabilité du fabricant mentionné ci-dessus.

Signé au nom du fabricant par:

Sébastien Doumenc
Directeur associé Aurlane
A paris, le 12/09/2018



ANNEXE I

code_produit	Designation
FAC030	PARMA 90
FAC055	PARMA 120
FAC069	DARK PARMA 90
FAC070	DARK PARMA 120
FAC071_2	PAROI COLIS 2/2 PACK LINE
FAC094	PARMA 140
FAC100	PARMA 140 DEPOLI / FROSTED
FAC098	PARMA 90 DEPOLI / FROSTED
FAC095	PARMA PIVOT 90/45
FAC096	PARMA PIVOT 120/45
FAC097	PARMA PIVOT 140/45
FAC099	PARMA 120 DEPOLI / FROSTED
FAC101	DARK PARMA 140
FAC106	PARMA 90 LIGHT
FAC110	PARMA PIVOT DEPOLI 90_45 / FROSTED 90_45
FAC111	DARK PARMA PIVOT 90_45
FAC191	PARMA 120 LIGHT
FAC201	PACK DEPOLIS
FAC246	PARMA 2 DARK 140
FAC245	PARMA 2 DEPOLI / FROSTED 140
FAC244	PARMA 2 TRANSPARENT 140
FAC243	PARMA 2 MIROIR / MIRROR 120
FAC242	PARMA 2 DARK 120
FAC241	PARMA 2 DEPOLI 120 / FROSTED 120
FAC240	PARMA 2 TRANSPARENT 120
FAC239	PARMA 2 LIGHT 120
FAC238	PARMA 2 MIROIR / MIRROR 90
FAC237	PARMA 2 DARK 90
FAC236	PARMA 2 DEPOLI / FROSTED 90
FAC235	PARMA 2 TRANSPARENT 90
FAC234	PARMA 2 LIGHT 90
FAC233	PARMA 2 MIROIR / MIRROR 80
FAC232	PARMA 2 DARK 80
FAC231	PARMA 2 DEPOLI / FROSTED 80
FAC230	PARMA 2 TRANSPARENT 80
FAC247	PARMA 2 MIROIR / MIRROR 140
FAC248	PARMA 2 PIVOT TRANSPARENT 40
FAC249	PARMA 2 PIVOT DARK 40
FAC250	PARMA 2 PIVOT DEPOLI / FROSTED PIVOT 40
FAC251	PARMA 2 PIVOT MIROIR /MIRROR 40
FAC288	PARMA 90 MIROIR
FAC289	PARMA 120 MIROIR
FAC290	PARMA 140 MIROIR
FAC346	CLEAN 100 - 6mm

FAC347	CLEAN 120 - 6mm
FAC348	CLEAN 100 - 8mm
FAC349	CLEAN 120 - 8mm
FAC300	PARMA 2 BLACK 140 TRANSPARANTE
FAC301	PARMA 2 BLACK 120 TRANSPARANTE
FAC302	PARMA 2 BLACK 90 TRANSPARANTE
FAC303	PARMA 2 BLACK 80 TRANSPARANTE
FAC304	PARMA 2 BLACK 40 TRANSPARANTE

ANNEXE 2 marquage CE

