

# Peak Atlas *IT*

*RJ45 Network Cable Analyser*  
*Model UTP05*

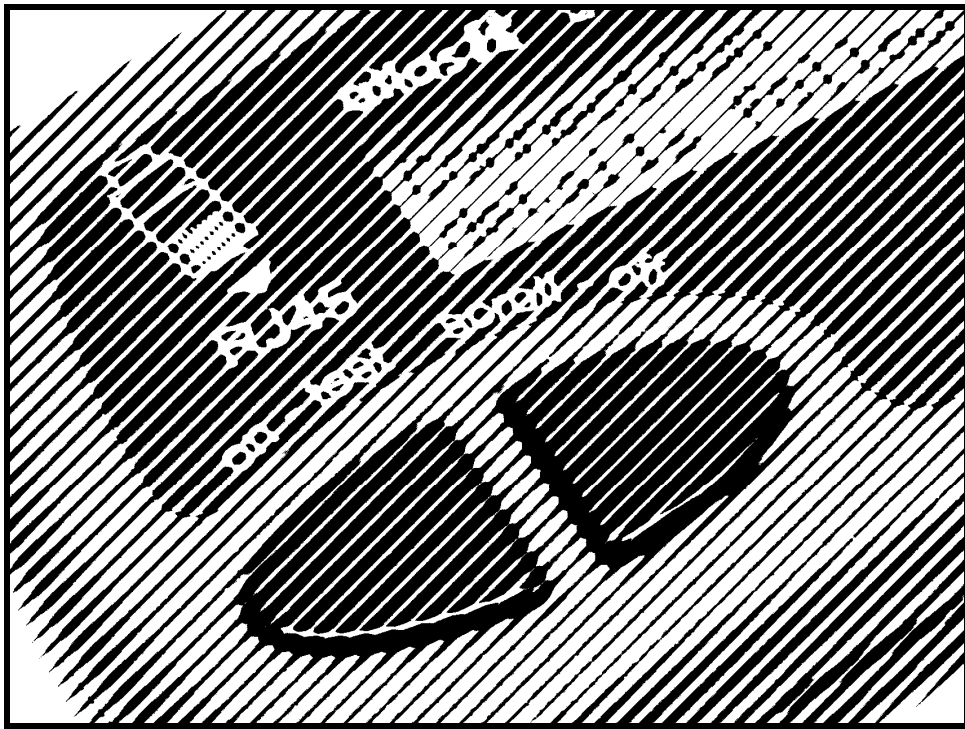

Designed and manufactured with pride in the UK

## User Guide

© Peak Electronic Design Limited 2001/2012

In the interests of development, information in this guide is subject to change without notice - E&OE



## PLEASE NOTE

This instrument is **ONLY** suitable for RJ45 plugs. This is confirmed on the front panel of your instrument.

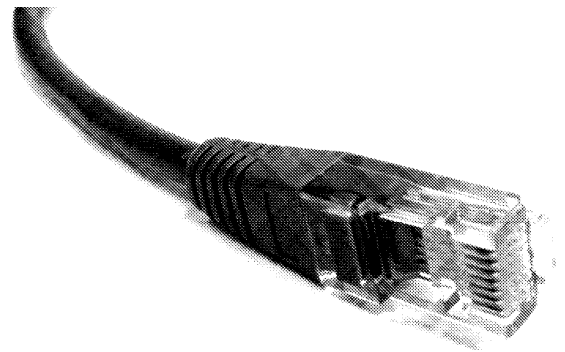

**Under no circumstances must any other type of connector be used, even if it seems to fit.**

In particular, use of telephone style RJ11 connectors WILL damage the instrument socket and the terminator socket permanently, leading to intermittent faulty readings that you can't rely on.

We are unable to provide warranty cover for misuse (by using connectors other than RJ45 connectors). The damage to the socket is easy for us to identify and cannot be caused in any other way.

We want you to have trouble-free use of your instrument, please ensure you only test RJ45 connectors.

**For your protection, please also read the important notices on Page 4 of this user guide.**

## **Want to use it now?**

We understand that you want to use your *Atlas IT* right now. The unit is ready to go and you should have little need to refer to this user guide, but please make sure that you do at least read page 4!

<b>Contents</b>	<b>Page</b>
Introduction .....	3
Important Notice .....	4
Background Information.....	5
Straight Through Cables	
Crossover Cables	
Other Cable Configurations	
Using Your <i>Atlas IT</i> .....	7
Analysis Results.....	9
Good Cables	
Faulty Cables	
Optional Identified Terminators .....	11
Display Cable-Making Instructions .....	12
Taking care of your <i>Atlas IT</i> .....	13
Appendix A - Accessories .....	14
Appendix B - Technical Specifications .....	15
Appendix C - Error/Warning Messages.....	16
Appendix D - Warranty Information .....	17
Appendix E - Disposal Information.....	18

## Introduction

---

The *Atlas IT* will quickly analyse your RJ45 network cables, sockets and patch panels.

### Summary Features:

- Automatic identification of cable type, such as straight-through patch cables, crossover cables, token-ring cables and many more.
- Cable type can usually be identified even if it is faulty.
- Fault type identification for all supported cable types, such as: swapped connections, broken connections, and shorted lines.
- Displays the full connection pattern of the cable being analysed.
- Compatible with optional Identified Terminators, allowing multiple cable runs to be uniquely identified and analysed.
- Supplied with patch cables for easy testing of network sockets and patch panels.
- Displays cable-making instructions when not testing cables.
- Supports cable lengths of up to 150m (500ft).
- Terminators are very small, ideal for use in tight spaces.
- Clear and user-friendly display.
- Auto power-on and power-off.



The *Atlas IT* verifies the continuity pattern between the two ends of a network cable. It does not verify that the cable is suitable for the data speeds used on the network.

## *Important Notice*

---

### **WARNING:**

**This instrument must NEVER be connected to cables or equipment that carries voltages that may exceed 80V, even for a short period. Failure to comply with this warning may result in personal injury, damage to the equipment under test, damage to the *Atlas IT* and invalidation of the manufacturer's warranty.**

**Additionally, the absolute voltage limit of 80V (between any pair of wires) is stated for a maximum duration of 15 seconds.**

**It is strongly advised to avoid testing cables that may carry “Power Over Ethernet” (POE).**

***“To prevent undesired operation, analysis of non-live systems is recommended.”***

**Please also note:** This instrument and the terminators must NOT be used with connectors other than RJ45 connectors.

## Background Information

Cat 5 (short for Category 5) network cables are typically used for 10 Base-T Networks and 100 Base-T Networks operating at 10Mbps and 100Mbps respectively. Many new networks are now being specified to operate at even higher data rates, these are sometimes referred to as Cat 5e (e for enhanced) and Cat 6 networks.

The cables themselves usually consist of 4 twisted pairs, a total of 8 lines. The actual connection pattern from one end of the cable to the other end depends on the network type and also the equipment type. Often, only 2 twisted pairs (4 wires) are actually used for data communication for many networks, however, for universal compatibility all 8 connections are normally wired.

### Straight-Through Patch Cables

The simplest network cables are simply called *Patch Cables* or *Straight-Through Cables*. These are normally wired with each of the 8 wires connected to the same corresponding contact at each end of the cable, 1 to 1, 2 to 2 and so on.

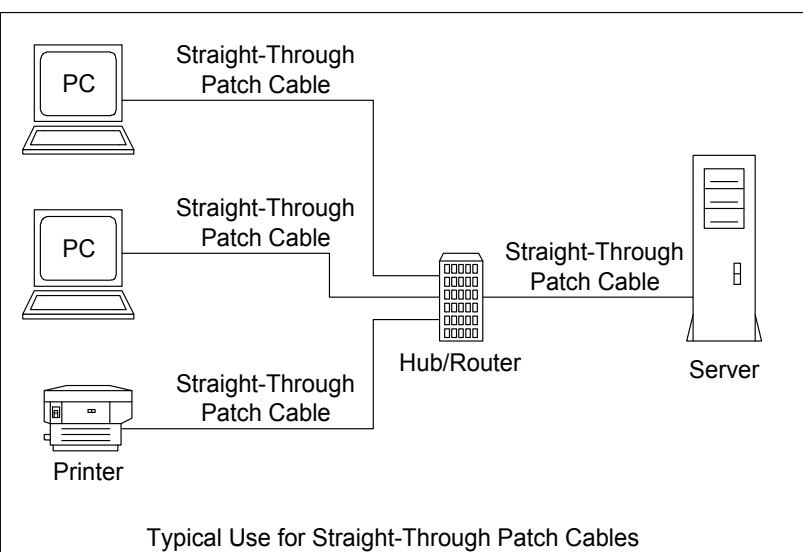
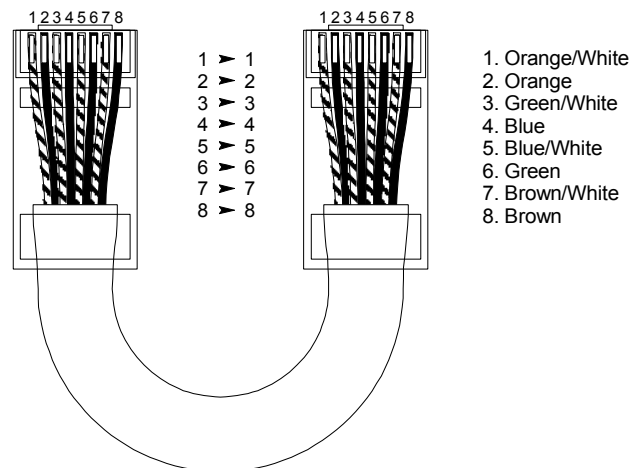

These are generally used for connecting computers to hubs (routers or switches) or simply between a PC and a wall socket (which eventually connects to a hub).

## Crossover Cables

Another common cable type is the crossover cable. The connection pattern for these cables is less intuitive than the straight-through type as can be seen here.

These cables are often used when connecting two computers directly together or for connecting an Ethernet enabled printer directly to a computer. They can also be used for expanding a hub or switch with another hub or switch.

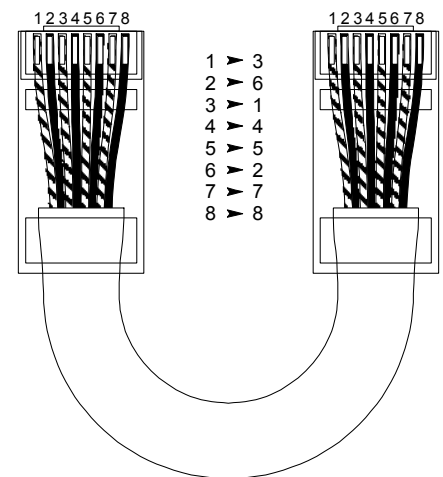

Please note, there are actually a number of wiring configurations that can be used to produce a crossover cable. The cable connection pattern shown above is the most common. However, the *Atlas IT* will recognise all variations.

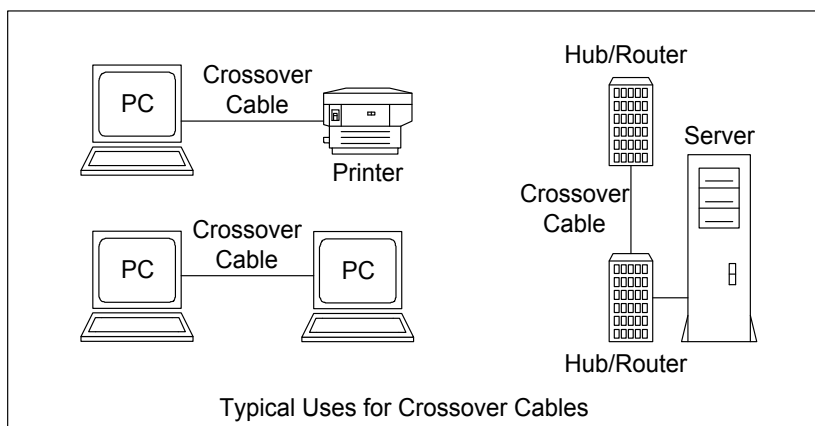

## Other Cable Configurations

There are many different connection patterns that are used for various applications, most of which are automatically recognised by the *Atlas IT*.

Please refer to the Ethernet Connection Chart in the middle of this booklet for further details.

## Using your Atlas IT

The *Atlas IT* can be used for many types of network installation or simply for testing a length of network cable.

The diagram (shown right) illustrates the simplest case, the *Atlas IT* Terminator is connected at one end of a cable and the *Atlas IT* instrument at the other.

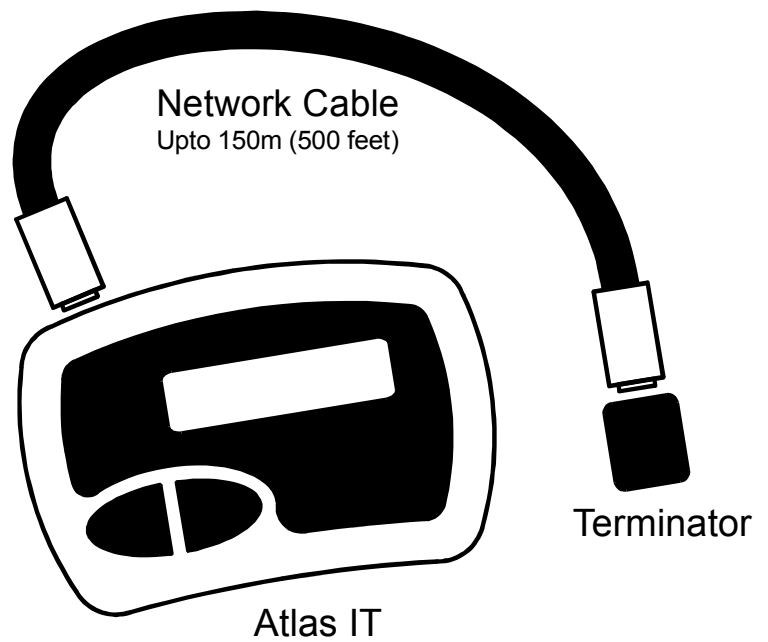

The *Atlas IT* is supplied with two short patch cables to allow for the testing of network cabling that is accessible only by sockets (or a patch panel). This is illustrated here:

Ideally, the total cable length should not exceed 150 metres (500 feet). Longer lengths may be analysed without problem but the overall supported length is dependant on factors such as cable quality, connector quality and external interference sources.

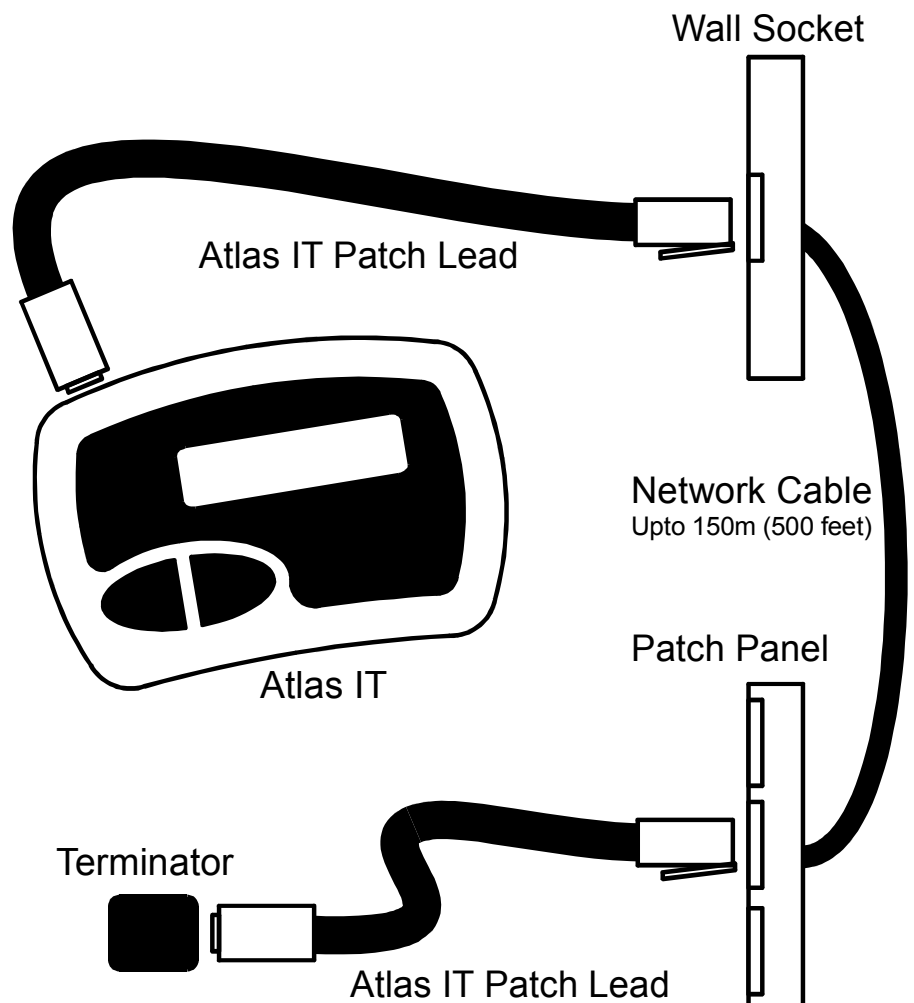



The *Atlas IT* can only provide useful information if the cabling being tested is not connected to other active equipment (such as computers, hubs and routers). Only the *Atlas IT* and the *Atlas IT* Terminator should be connected to the cabling.

 Please note that some combined Voice and Data installations can carry high “ringer” voltages. The *Atlas IT* can cope with short durations of 80V, but no higher.

When the distant end of the cabling has been connected to the *Atlas IT* Terminator and the local end has been connected to the *Atlas IT* instrument, you are ready to perform a test.

Simply press the **on-test** button.

The *Atlas IT* will first perform a short search procedure to determine if it can detect an *Atlas IT* Terminator. When this has been detected, it will then proceed to a full analysis of the cable.



After a few seconds, the unit will display the analysis results.

Results are display a page at a time, simply press the **scroll-off** button briefly to proceed to the next page when you're ready. Pressing the button repeatedly will eventually get you back to the first page again.

To turn off the *Atlas IT*, you can hold down the **scroll-off** button, or simply wait for it to switch off automatically.

## Analysis Results

---

### Good Cables

If the cable being tested is good, the *Atlas IT* will display a message similar to this:

```
Good 8-Wire
Patch cable +
```

The first page to be displayed tells you the type of connection configuration for the cable you're testing, in this case a simple 8-wire patch cable (straight-through).

The arrow on the bottom-right of the display reminds you that more information is available on the next page, briefly press **scroll-off** when you're ready.

The next information to be displayed is the confirmation of the full connection pattern between the terminator "Term" and the *Atlas IT* "Atlas":

```
Connection
details follow +
Term+ 12345678
Atlas+ 12345678 +
```

As can be seen from the display here, the connections are verified as being those relating to a normal straight through patch cable. The connections between the *Atlas IT* Terminator end of the cable are shown together with the corresponding

connections on the *Atlas IT* end of the network cable.

The displayed cable type and connection pattern depends on the type of cable being analysed of course, as a further example the following would be displayed for a good 8-wire crossover cable:

```
Good 8-Wire
crossover cable +
Connection
details follow +
Term+ 12345678
Atlas+ 36145278 +
```

## Faulty Cables

If the cable connection pattern does not match any of the standard cable types in the *Atlas IT* library, the unit will attempt to find the closest match.

The cable may be faulty for a number of different reasons: broken lines, shorted lines, swapped or incorrectly wired lines. All these fault types will be clearly displayed on the *Atlas IT*.

### Missing connection(s):

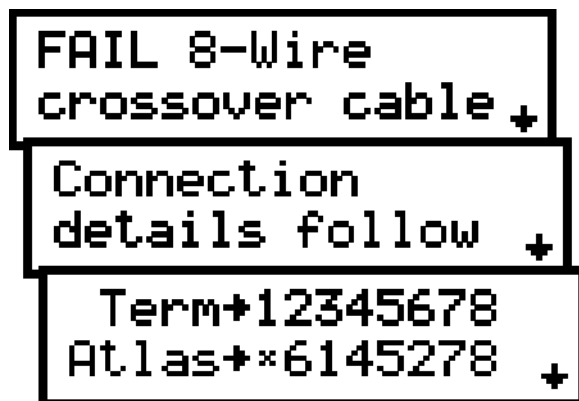

In this example, the closest cable type match is an 8-wire crossover cable. Pressing the **scroll-off** button to view the next pages reveals the nature of the fault.

Here, a flashing cross symbol indicates a missing connection.

### Shorted connection(s):

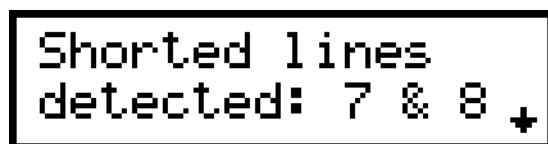

This message means the *Atlas IT* has detected a short circuit between the two lines, 7 & 8. These line numbers are as “seen” at the *Atlas IT* end of the cable. If more than 2 wires are shorted, just the first shorted pair are shown.

### Swapped Lines:

Incorrectly wired lines will be flashed on the connection details display. In this case, lines 6 and 3 are swapped.

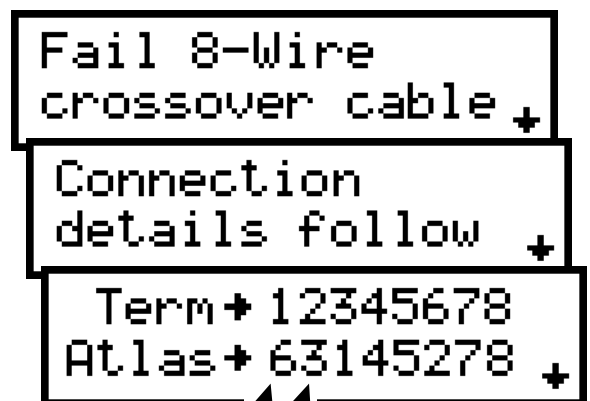

↑↑  
flashing

## Optional Identified Terminators

The *Atlas IT* (from firmware version 2.0 and later) supports the use of Identified Terminators.

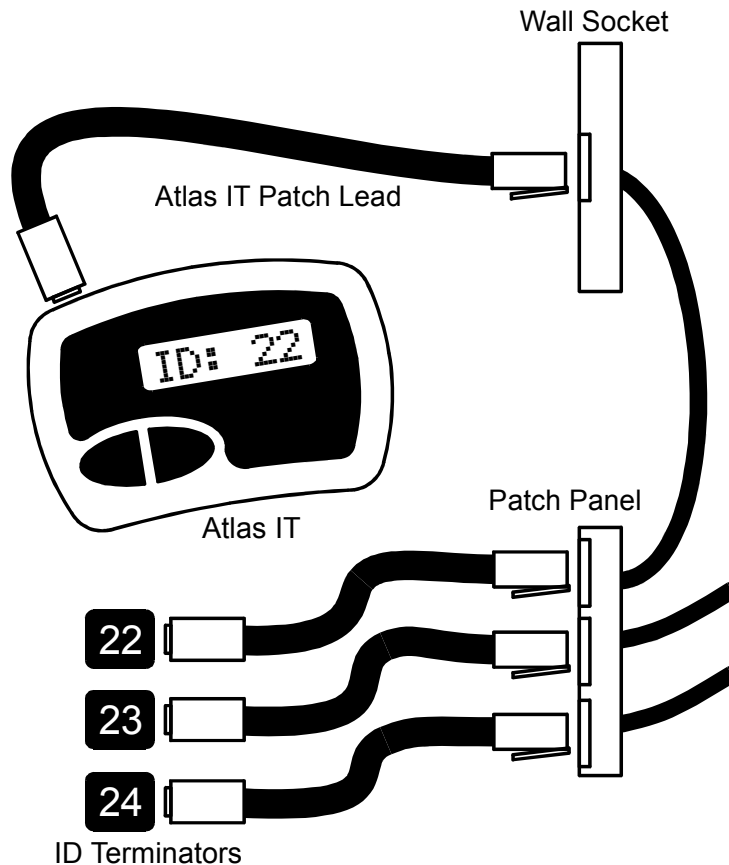

These special terminators can be used in exactly the same way as the standard (non-identified) terminators. They are automatically recognised by the *Atlas IT* and the identity number is displayed along with the cable analysis results.

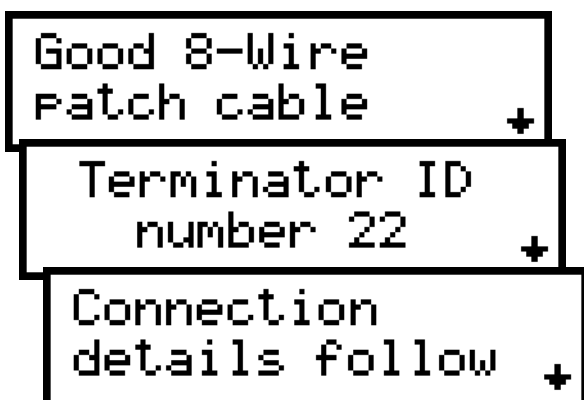

Up to 24 Identified Terminators are available, allowing for the rapid testing, and identification of large numbers of network cables or sockets.

The number of the Identified Terminator may not be displayed if there are cable faults or if some of the connections between the *Atlas IT* and the terminator are missing (e.g. 4-wire economy patch cables).

## Display Cable-Making Instructions

---

If the *Atlas IT* is started without a network cable and terminator connected, brief instructions on the connections for common network cables are displayed.

The displayed instructions are only to serve as a reminder of course, please seek guidance from a qualified person if you are unsure how to implement this information:

```

Atlas Terminator
not detected. +
To make Straight
thru (PC-Hub): +
End1 + 12345678
End2 + 12345678 +
To make Cross-
Over (PC-PC): +
End1 + 12345678
End2 + 36145278 +
Line 1 colour:
Orange/White +
Line 2 colour:
Orange +
Line 3 colour:
Green/White +
  
```

← First the unit confirms the connection patterns for the two most common cable configurations (Straight-Through Patch cables and Crossover cables).

← The colours of all 8 wires are then displayed.

It is important to note that lines 1&2, 3&6, 4&5 and 7&8 are twisted pairs.

Refer to the Ethernet Connection Chart for more cable connection details.

## Taking care of your *Atlas IT*

---

### Battery Replacement

The *Atlas IT* requires no special maintenance, although the battery should be replaced every 12 months to prevent leak damage.

**\* Low Battery \***

If this message is displayed, the battery should be replaced as soon as possible to prevent malfunction or leak damage.

The unit may continue to operate following a low battery warning, performance however, may be adversely affected.

To replace the battery, unscrew the three screws to remove the rear panel. Remove the old battery and insert a new one, taking care to observe the correct polarity.

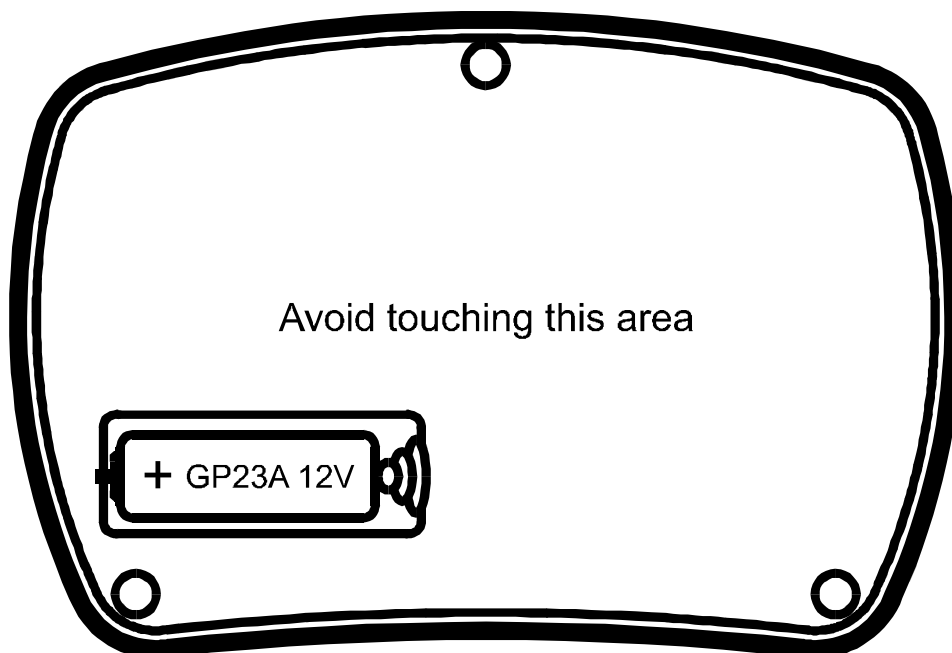

The battery should be replaced with a high quality battery identical to, or equivalent to an Alkaline 23A, V23A, GP23A, MN21 12V (10mm diameter x 28mm length). Carefully replace the rear panel, do not over-tighten the screws.

## **Appendix A – Accessories**

---

A range of useful additions is available from Peak or an authorised distributor to enhance your *Atlas IT*.

### **Identified Terminators**

Sets of 8 Identified Terminators are available with the following range of ID numbers: 1-8, 9-16 and 17-24. The terminators are automatically recognised by your *Atlas IT* and will help you identify, analyse and number many cable runs in quick succession.

### **Mini-Patch Cables**

If you wish to test many sockets at a time you may benefit from purchasing extra patch cables. These mini patch cables are made from extra-flexible stranded cores that offer ease-of-use and durability.

### **RJ45 Breakout Adapter**

A unique adapter has been designed to enhance your *Atlas IT* for the analysis of un-terminated cabling. This is a professional assembly complete with strain-relief, robust RJ45 plug and 8 flexible wires which are brought out to numbered gold-plated crocodile clips. Ideal for the rapid connection and analysis of cables or for prototyping special configurations.

### **Non-Identified Terminators**

Replacement terminators are available if you have lost or damaged the supplied terminators.

## Appendix B – Technical Specifications

---

Parameter		Notes
Network Cable Category	Cat 5, 5e, 6 (UTP)	5
Connection Type	RJ45, 8 pin.	
Maximum Cable Length	150 metres (500 feet)	1
Test Voltage	±5V	
Test Current	±2.5mA	
Protection Rating	±15V	2
	±80V	3
Operating Temperature Range	10°C to 50°C	4
Battery Voltage Range	7.0V to 13.0V	
Battery Type	GP23A 12V Alkaline	
Atlas IT Dimensions	103 x 70 x 20 mm	
Terminator Dimensions	18 x 15 x 14 mm	

### Notes:

1. Dependant on quality of cable, connections and influence of external interference.
2. Specified for durations no longer than 60 seconds.
3. Specified for durations no longer than 15 seconds.
4. Subject to acceptable LCD visibility.
5. Shield connection is not tested.

 Every effort has been made to ensure that this product will reliably and accurately analyse all supported network cable types. It is possible however that under extreme conditions of cable length, electrical environment and installed hardware that the *Atlas IT* will generate inaccurate readings. Please contact us if you have any doubts.



## Appendix C – Error/Warning Messages

---

Atlas Terminator  
not detected. +

The *Atlas IT* cannot detect the terminator. It is possible that the cable has too many broken connections or the terminator itself is damaged.

Only lines 1 & 3  
connected.

It is not possible to display a full connection pattern if only 2 wires are connected between the *Atlas IT* and the Terminator.

Unrecognised or  
faulty cable. +

This will be displayed if the cable being analysed is not similar to any of the types stored in the *Atlas IT*. The connection pattern will still be displayed however.

Voltase Detected  
\* Error Code 3 \*

The unit is designed for testing non-live network cables, if excessive voltages are detected or an internal fault has occurred then this message may be displayed.

May be connected  
to PC or Hub! +

This may be displayed if *Atlas IT* has been connected to a live network connection rather than an *Atlas IT* Terminator.

## **Appendix D - Warranty Information**

---

### **Peak Satisfaction Guarantee**

If for any reason you are not completely satisfied with the *Peak Atlas IT* within 14 days of purchase you may return the unit to your distributor. You will receive a refund covering the full purchase price if the unit is returned in perfect condition.

### **Peak Warranty**

The warranty is valid for 24 months from date of purchase. This warranty covers the cost of repair or replacement due to defects in materials and/or manufacturing faults.

The warranty does not cover malfunction or defects caused by:

- a) Operation outside the scope of the user guide.
- b) Damage caused by connection to voice/ringer voltages.
- c) Damage caused by connection to Power-over-Ethernet.
- d) Unauthorised access or modification of the unit (except for battery replacement).
- e) Accidental physical damage or abuse.
- f) Normal wear and tear.

The customer's statutory rights are not affected by any of the above.

All claims must be accompanied by a proof of purchase.

## **Appendix E – Disposal Information**

---



### **WEEE (Waste of Electrical and Electronic Equipment), Recycling of Electrical and Electronic Products**

#### **United Kingdom**

In 2006 the European Union introduced regulations (WEEE) for the collection and recycling of all waste electrical and electronic equipment. It is no longer permissible to simply throw away electrical and electronic equipment. Instead, these products must enter the recycling process.

Each individual EU member state has implemented the WEEE regulations into national law in slightly different ways. Please follow your national law when you want to dispose of any electrical or electronic products.

**More details can be obtained from your national WEEE recycling agency.**

If in doubt, you may send your Peak Product to us for safe and environmentally responsible disposal.

At Peak Electronic Design Ltd we are committed to continual product development and improvement.  
The specifications of our products are therefore subject to change without notice.

© 2001-2012 Peak Electronic Design Limited - E&OE  
Designed and manufactured in the UK  
www.peakelec.co.uk Tel. +44 (0) 1298 70012 Fax. +44 (0) 1298 70046