

# LT-DMX-1809 DMX-SPI Signal Decoder



LT-DMX-1809 converts the universal standard DMX512 signal into SPI(TTL) digital signal to drive LEDs with compatible driving IC, it could control every channel of the LED lights, realize 0~100% dimming or editing all sorts of changing effect.

DMX-SPI decoder are widely used in LED flashing word string light, LED dot light, SMD strip, LED digital tubes, LED wall light, LED pixel screen, Hi-power spotlight, flood light, etc.

## 1. Product Parameter:

LT-DMX-1809			
Input Signal:	DMX512	Dimming Range:	0~100%
Input Voltage:	5~24Vdc	Working Temperature:	-30°C~65°C
Output Signal:	SPI	Dimensions:	L125×W64×H40(mm)
Decoding Channels:	512 Channels/Unit	Package Size:	L135×W70×H50(mm)
DMX512 Socket:	3-pin XLR, Green Terminal	Weight (G.W.):	300g
Compatible with WS2811/WS2812/WS2812B, UCS1903/UCS1909/UCS1912/UCS2903/UCS2909/UCS2912 TM1803/ TM1804/TM1809/1812/GS8206(BGR)/SM16703 driving IC.			

Note: grey level from best or worst depend on the IC types, it is nothing with the LT-DMX-1809 decoder performance.

## 2. Configuration Diagram:

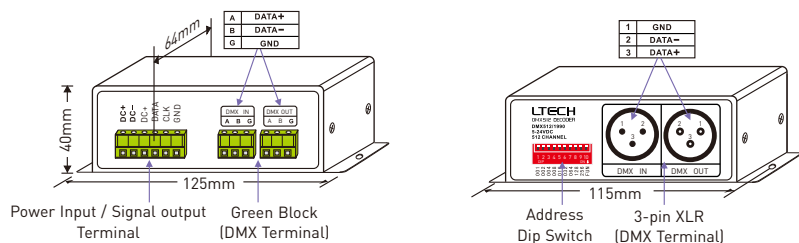

## 3. Output Port Definition:

No.	Port	Function
1	Power Supply Input Port	DC+
		DC-
2	Output Port Connect LED	DC+
		DATA
		CLK
		GND

## 4. Dip Switch Operation:



### 4.1 How to set DMX address via dip switch:

FUN=OFF (the 10th dip switch=OFF) DMX Mode

The Decoder enter into DMX control mode automatically when receiving DMX signal.

Like figure upward: FUN=OFF is high speed(upward), FUN=ON is low speed (downward)

- The driving chip of this decoder has option for high and low speed(800K/400K), please choose the suitable speed according to the design of your LED lights, in most cases, it is high speed.
- DMX address value = the total value of [1-9], to get the place value when "on" position, otherwise will be 0.

E.g.1: Set Initial Address To 32.

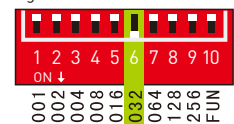

E.g.2: Set Initial Address To 37.

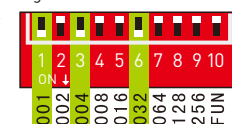

E.g.3: Set Initial Address To 178.



### 4.2 Self-testing Mode:

When no DMX signal, Self-testing Mode

Dip Switch	1-9=off	1=on	2=on	3=on	4=on	5=on	6=on	7=on	8=on	9=on
Self-test Function	Static Black	Static Red	Static Green	Static Blue	Static Yellow	Static Purple	Static Cyan	Static White	7 Colors Jumping	7 Colors Smooth

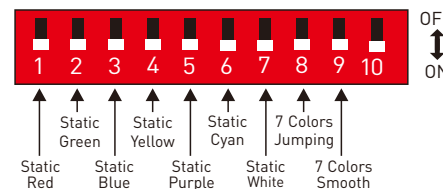

For changing effects (Dip Switch 8/9=ON): DIP switch 1-7 is used to realize 7 speed levels. (7=ON, the fastest level)

[Attn] When several dip switches are ON, subjected to the highest switch value.

As the figure above shows, the effect will be 7 colors smooth at 7 speed level.

5. Wiring Diagram:

5.1 LED pixel strip wiring diagram.

A. Conventional connection method.

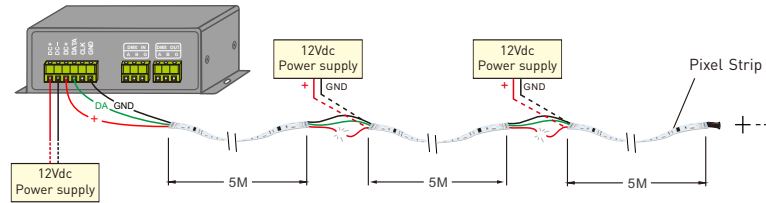

B. Special connection method - light fixtures and controller using different operating voltages.

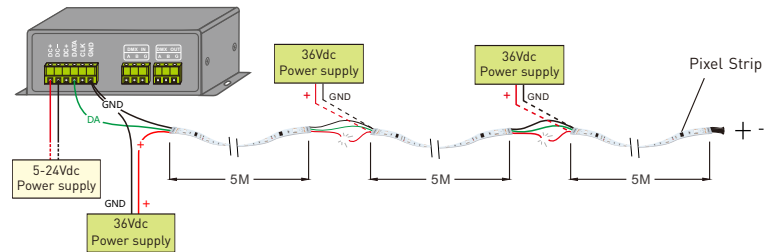

5.2 DMX wiring diagram.

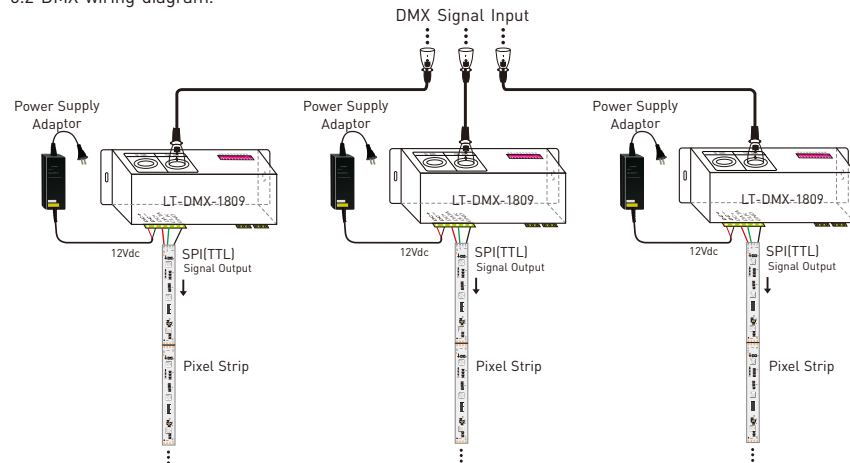

\* An amplifier is needed when more than 32 decoders are connected, signal amplification should not be more than 5 times continuously.

6. Attention:

- 6.1 The product shall be installed and serviced by the qualified person.
- 6.2 This product is non-waterproof. Please avoid the sun and rain. When installed outdoors please ensure it is mounted in a water proof enclosure.
- 6.3 Good heat dissipation will prolong the working life of the controller. Please ensure good ventilation.
- 6.4 Please check if the output voltage of the LED power supply used comply with the working voltage of the product.
- 6.5 Please ensure that adequate sized cable is used from the controller to the LED lights to carry the current. Please also ensure that the cable is secured tightly in the connector.
- 6.6 Ensure all wire connections and polarities are correct before applying power to avoid any damages to the LED lights.
- 6.7 If a fault occurs, please return the product to your supplier. Do not attempt to fix this product by yourself.

7. Warranty Agreement:

7.1 We provide lifelong technical assistance with this product:

- A 5-year warranty is given from the date of purchase. The warranty is for free repair or replacement if cover manufacturing faults only.
- For faults beyond the 5-year warranty, we reserve the right to charge for time and parts.

7.2 Warranty exclusions below:

- Any man-made damages caused from improper operation, or connecting to excess voltage and overloading.
- The product appears to have excessive physical damage.
- Damage due to natural disasters and force majeure.
- Warranty label, fragile label and unique barcode label have been damaged.
- The product has been replaced by a brand new product.

7.3 Repair or replacement as provided under this warranty is the exclusive remedy to the customer. We shall not be liable for any incidental or consequential damages for breach of any stipulation in this warranty.

7.4 Any amendment or adjustment to this warranty must be approved in writing by our company only.

★This manual only applies to this model. We reserve the right to make changes without prior notice.