

INSTRUCTION MANUAL

(NL) Gebruikte symbolen

(GB) Safety Precautions / (FR) Symboles utilisés / (DE) Verwendete Symbole / (PL) Stosowane symbole / (NO) Brukte symboler / (DK) Brugte symboler / (SE) Använda symboler / (FI) Käytetyt symbolit / (IT) Simboli usati / (ES) Símbolos empleados / (CZ) Použité symboly / (PT) Símbolos utilizados / (GR) Χρησιμοποιούμενα σύμβολα



Crowe Fan 1 Silver Smart 105202

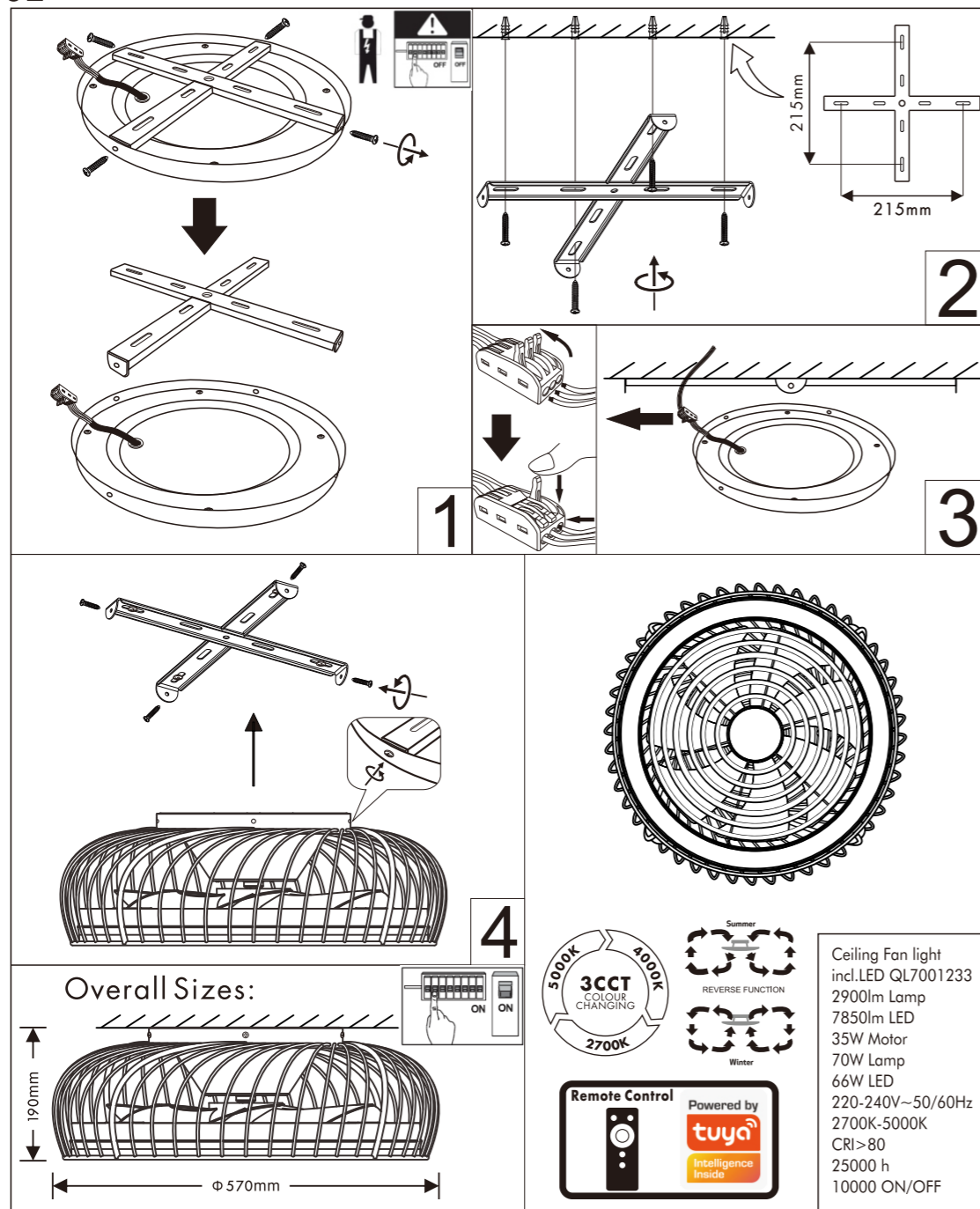

Speed (rpm)			Sound (db)			Application		Function			Motor	
Max rpm	Med rpm	Min rpm	db Max rpm	db Med rpm	db Min rpm	Circulating Air m³/min	Max Surface in m²	Speed Setting	Timer Function yes/no	Seasonal profiles winter/summer/both	Fan Motor AC/DC	Watt Motor
950	475	300	51	41	30	102	Lamp 15-20m² FAN 4m²	3	yes	both	DC	35W

Warnings:
Do not poke any objects or fingers through the protective screens.
Do not place any objects, such as clothing, on the device.
Be careful with long hair. These can be sucked in by the air flow, keep sufficient distance.

FittinQ B.V.
Smaragdweg 52, 5527 LB Hapert,
The Netherlands
www.qazqa.nl

FittinQ LTD
55 Baker Street,
London, W1U 7EU
United Kingdom

QAZQA

INSTRUCTION MANUAL

(NL) Gebruikte symbolen

(GB) Safety Precautions / (FR) Symboles utilisés / (DE) Verwendete Symbole / (PL) Stosowane symbole / (NO) Brukte symboler / (DK) Brugte symboler / (SE) Använda symboler / (FI) Käytetyt symbolit / (IT) Simboli usati / (ES) Símbolos empleados / (CZ) Použité symboly / (PT) Símbolos utilizados / (GR) Χρησιμοποιούμενα σύμβολα

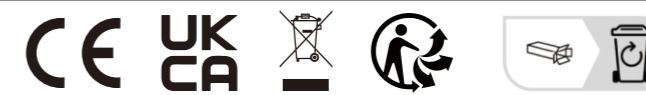

1. REMOTE CONTROL

The remote control included with the lamp is already connected and ready to use once the batteries are installed.

Type number remote: RF2.4G
RF frequency range: 2440MHz
Transmit power: 4dBm
Coverage area: 5m
Matched with 2 pcs AAA battery

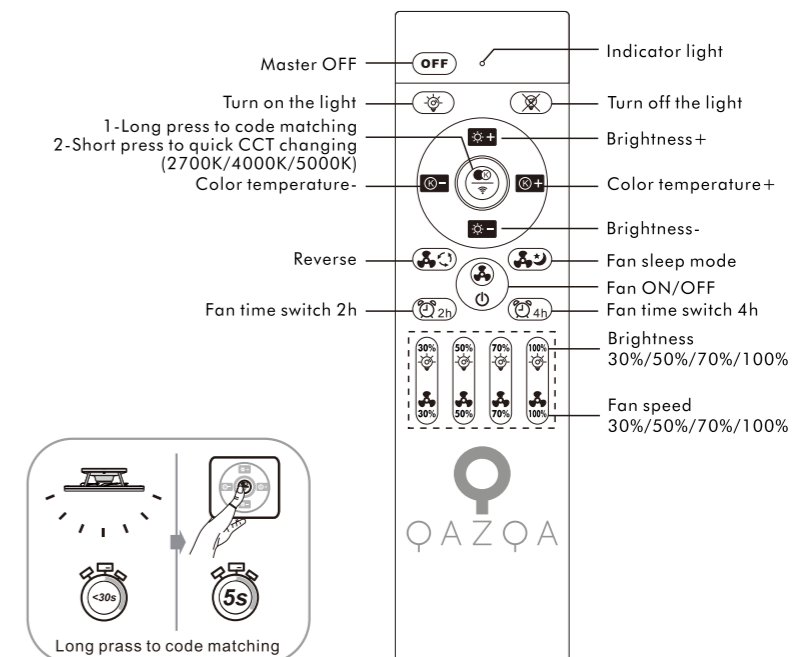

2. APP TUYA SMART

PREPARATION

- Connect the mobile phone to the Wi-Fi network.(2.4GHz band)
- Download "Tuya APP". Available in IOS and Android or scan the attached QR code.
if you are a new APP user, you can register by clicking the "Register" button and following the registration instructions. If you already have an account registered under "Tuya", you can access the login page by clicking on the "Login with an existing username" button.

HOW TO CONFIGURE THE LIGHTING FIXTURE

Turn off the fan for at least 5 seconds. Then turn on the fan and press for 10 seconds (ON and OFF) at the same time on the remote control until the fan blinks 3 times. After a few seconds it will start flashing **fast**.

HOW TO LINK THE LIGHTING FIXTURE IF THE LIGHT FLASHES RAPIDLY:

- (1) Start the application, click "Add Device" or "+" in the upper right corner of the screen.
- (2) Select "Small Home Appliances" on the device list page, then "Fan Devices(Wi-Fi)".
- (3) Click the orange button confirming that the fan flashes quickly.
- (4) Select your Wi-Fi connection. Enter your Wi-Fi password and click "Confirm" to proceed to the next step.
- (5) At this point the fan will attempt to connect to your wi-fi network.
- (6) If the fan connects correctly, simply click the "Done" button. But first it would be convenient to "rename" the fan as you wish(e.g. Bedroom).

Simplified Declaration of Conformity:

Hereby, FittinQ BV declares that the radio equipment type [designation of type of radio equipment] is in compliance with Directive 2014/53/EU.
The full text of the EU declaration of conformity is available at the following internet address:
www.qazqa.nl

FittinQ B.V.
Smaragdweg 52, 5527 LB Hapert,
The Netherlands
www.qazqa.nl

FittinQ LTD
55 Baker Street,
London, W1U 7EU
United Kingdom

QAZQA

INSTRUCTION MANUAL

Crowe Fan 1 Silver Smart 105202

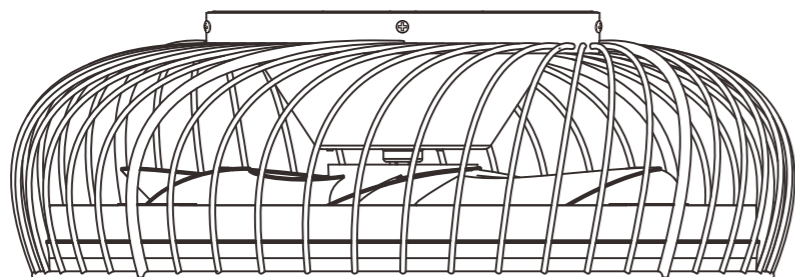

Ceiling Fan light
incl.LED QL7001233
2900lm Lamp
7850lm LED
35W Motor
70W Lamp
66W LED
220-240V~50/60Hz
2700K-5000K
CRI>80
25000 h
10000 ON/OFF

<p>(DE) Dieses Produkt enthält eine Lichtquelle der Energieeffizienzklasse E (EN) This product contains a light source of energy efficiency class E (FR) Ce produit comprend une source de lumière de classe d'efficacité énergétique E (NL) Dit product bevat een lichtbron van energie-efficiëntieklasse E (PL) Produkt ten zawiera źródło światła o klasie efektywności energetycznej E (NO) Dette produktet inneholder en lyskilde i energieeffektivitetsklasse E (DK) Dette produkt indeholder en lyskilde af energieeffektklasse E (SE) Denna produkt innehåller en ljuskälla i energieeffektivitetsklass E (FI) Tämä tuote sisältää energiatehokkuusluokan E valonlähteen (IT) Questo prodotto contiene una sorgente luminosa della classe di efficienza energetica E (ES) Este producto contiene una fuente de luz de la clase de eficiencia energética E (CZ) Tento výrobek obsahuje světelný zdroj třídy energetické účinnosti E (PT) Este produto contém uma fonte de luz da classe de eficiência energética E (GR) Αυτό το προϊόν περιέχει μια φωτεινή πηγή ενεργειακής απόδοσης κλάσης E (SK) Tento výrobok obsahuje zdroj svetla triedy energetickej efektivity E</p>	<p>QR</p> 	<p>EAN</p> <p>8718881135422</p>
--	---	---

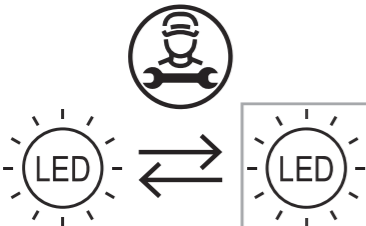

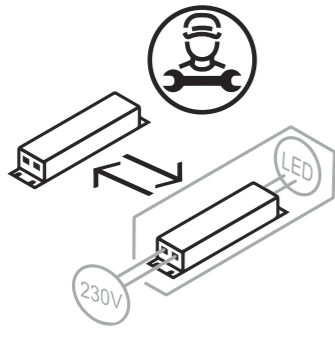







	<p>(DE) Durch einen Fachmann austauschbare Lichtquelle (nur LED) (EN) Replaceable (LED only) light source by a professional. (FR) Source de lumière remplaçable (LED uniquement) par un professionnel. (NL) Lichtbron (alleen led) te vervangen door een professional. (PL) Wymienne (tylko LED) źródło światła wykonane przez profesjonalistę. (NO) Utskiftbar (kun LED) lyskilde av en profesjonell. (DK) Udskiftelig lyskilde (kun LED), udskiftes af en elektriker. (SE) Ljuskälla (endast LED) utbytbar genom fackman. (FI) Ammattilainen voi vaihtaa vaihdettavan (vain LED) valonlähteen. (IT) Sorgente luminosa (solo LED) sostituibile da un professionista. (ES) Fuente de luz (solo LED) sustituible por un profesional. (CZ) Vyměnitelný (pouze LED) světelný zdroj odborníkem. (PT) Luz LED (apenas LED) substituível por um profissional. (GR) Η πηγή φωτός (μόνο LED) να αντικαθίσταται από επαγγελματία. (SK) Zdroj svetla (iba LED) vymeniteľný prostredníctvom odborníka.</p>
---	--

	<p>(DE) Durch einen Fachmann austauschbares Betriebsgerät. (EN) Replaceable control gear by a professional. (FR) Contrôleur remplaçable par un professionnel. (NL) Voorschakelapparatuur te vervangen door een professional. (PL) Wymienny układ sterujący przez profesjonalistę. (NO) Utskiftbar kontrollutstyr av en profesjonell. (DK) Udskiftelig igangsætter, udskiftes af en elektriker. (SE) Styrdon utbytbar genom fackman. (FI) Ammattilainen voi vaihtaa vaihdettavat ohjauslaitteet. (IT) Dispositivo di controllo sostituibile da un professionista. (ES) Dispositivo de control sustituible por un profesional. (CZ) Vyměnitelný předřadník odborníkem. (PT) Dispositivo de controlo substituível por um profissional. (GR) Ο εξοπλισμός ελέγχου να αντικαθίσταται από επαγγελματία. (SK) Predradník vymeniteľný prostredníctvom odborníka.</p>
---	---

SAFETY INSTRUCTION



Please study the instruction manual and below information carefully before installing or using this product.
Please keep this user manual for further reference

- The luminaires may only be installed by authorized and qualified technicians according to the valid regulations for electrical installation.
- Maintenance of the luminaires is limited to their surfaces. During maintenance no moisture can come into contact with any areas of the terminal connections or voltage control parts.
- The electrical supply must be switched off at the outset, preferably by means of a switch in the distribution box, before any installation, maintenance or repair work is undertaken.
- Exterior lighting must not be installed during rain.
- Take account of the minimal separation distance from other objects and the room required around the fitting.
- If in any doubt, consult a professional, taking local installation requirements into account. Some countries stipulate that lighting may be installed only by registered installers.
- Clamping screws in electrical connections must be adequately tightened. This is particularly the case with 12V low voltage conductors.
- Clean with a clean, dry cloth or brush, use no solvents or abrasives. Avoid dampness on all electrical components
- Take account of all available technical information.
- Meaning of symbols:

-  This icon indicates the level of water-proof and dust-proof
-  Protection Class I: the fitting must be earthed
-  Protection Class II: the fitting is doubled insulated and does not require earthing
-  Protection Class III: the fitting is low voltage
-  Minimum distance from lighted objects (meters)
-  The type of lamp and maximum size and wattage indicated in each lighting unit must not be exceeded; different items require different kind of light sources with different bulb icons
-  220-240V-50Hz
The armature is designed to work only with the indicated voltage. Different items require different working voltage.
-  The luminaire can be used in combination with a dimmer
-  The luminaire can be dimmed by wall switch
-  The reference light angle and light space of the luminaire
- 

This luminaire cannot be disposed together with normal domestic waste in standard rubbish can, but you have to bring it to a staging area for electrical waste

1.1. Take note of the symbols when connecting wires:

	(DE)	(GB)	(FR)	(NL)	(PL)	(NO)	(DK)
L	Stromführender Leiter	Live conductor	Conducteur	Spanning-voerende draad	Przewód prądowy	Strømførende leder	Strømførende leder
	Schutzleiter	Earth conductor	Conducteur de protection (terre)	Aardkabel	Przewód uziemiający	Jordledningen	Jordledningen
N	Neutralleiter	Neutral conductor	Conducteur neutre	Nulleider	Przewód zerowy	Nøytralleider	Neutralleider
	(SE)	(FI)	(IT)	(ES)	(CZ)	(PT)	(GR)
L	Strömförande ledare	Virtajohdin	Conduttore sotto tensione	Conductor de corriente	Vodič pod napětím	Condutor vivo	Ρευματοφόρος αγωγός
	Skyddsledare	Suojajohdin	Conduttore di terra	Conductor de protección	Ochranný vodič	Condutor de terra	Αγωγός γείωσης
N	Neutralledare	Nollajohdin	Conduttore neutro	Conductor neutro	Neutrální vodič	Condutor neutro	Ουδέτερος αγωγός