

# APEK601



ES: Escanea este código QR para ver las instrucciones actualizadas y posibles vídeos tutoriales.

EN: Scan QR code for updated manual and possible tutorial videos.

FR: Scannez ce code QR pour voir les instructions mises à jour et les vidéos possible.







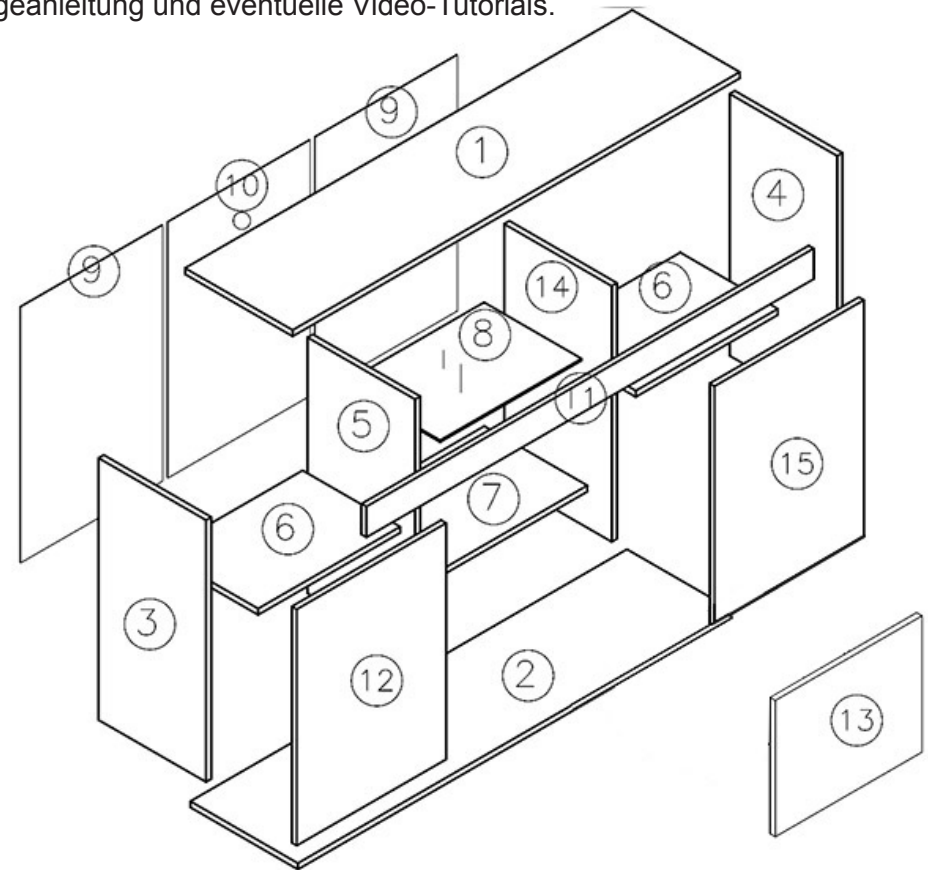
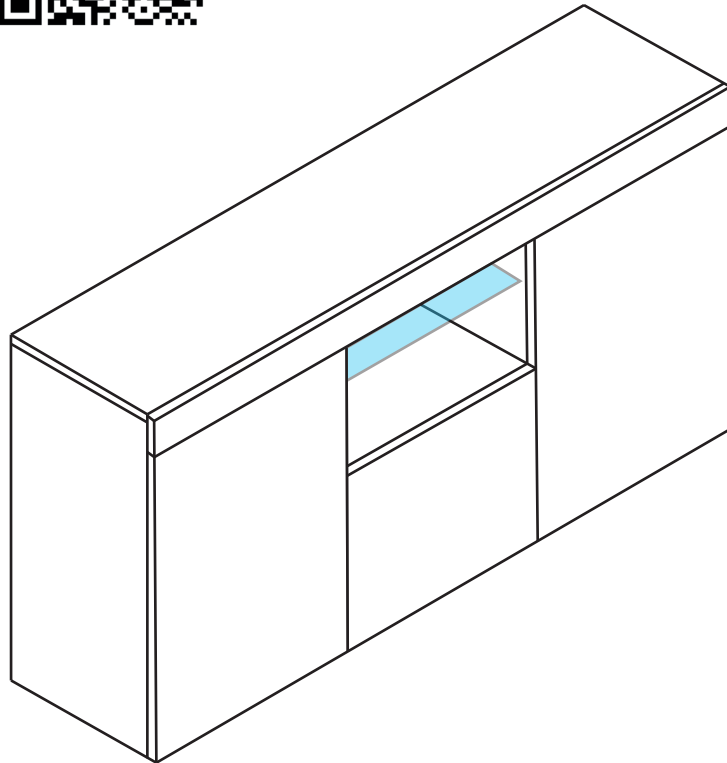

IT: Scannerizzate il codice QR per vedere le istruzioni aggiornate ed eventuali tutorial video.

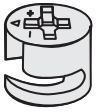
PT: Faça o scan deste código QR para obter instruções atualizadas e possíveis vídeos.

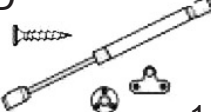

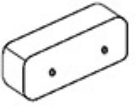

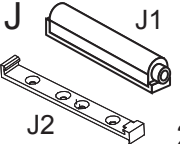
NL: Scan de QR code voor de actuele montagehandleiding en eventuele video met uitleg.

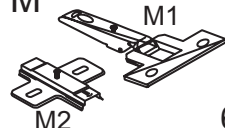
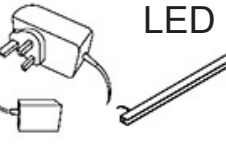
DE: Scannen Sie den QR-Code für die aktuelle Montageanleitung und eventuelle Video-Tutorials.

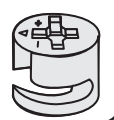

<b>A</b>  25	<b>B</b>  25	<b>C</b>  24	<b>D</b>  1	<b>E</b>  4	<b>F</b>  8	<b>G</b>  5
<b>H</b>  3,5x16 28	<b>I</b>  3,5x30 10	<b>J</b>  J1 2 J2	<b>K</b>  1	<b>L</b>  8	<b>M</b>  M1 6 M2	<b>LED</b> 

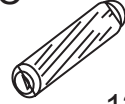
11

<p>A</p>  <p>12</p>	<p>B</p>  <p>20</p>	<p>C</p>  <p>12</p>	<p>M2</p>  <p>6</p>	<p>H</p>  <p>12</p>
---	---	--	--	--

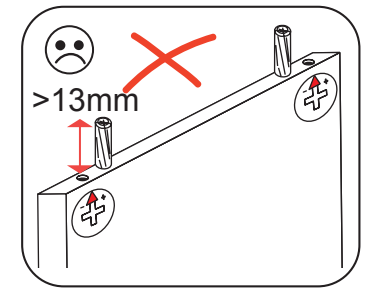
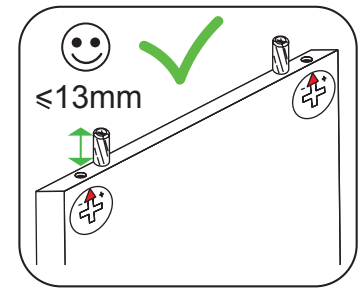
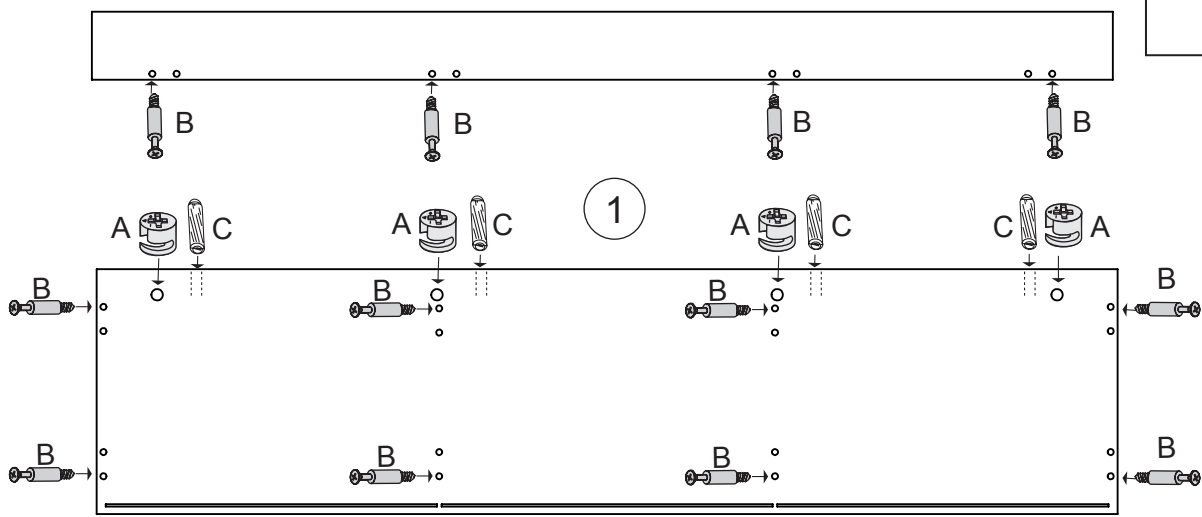

2

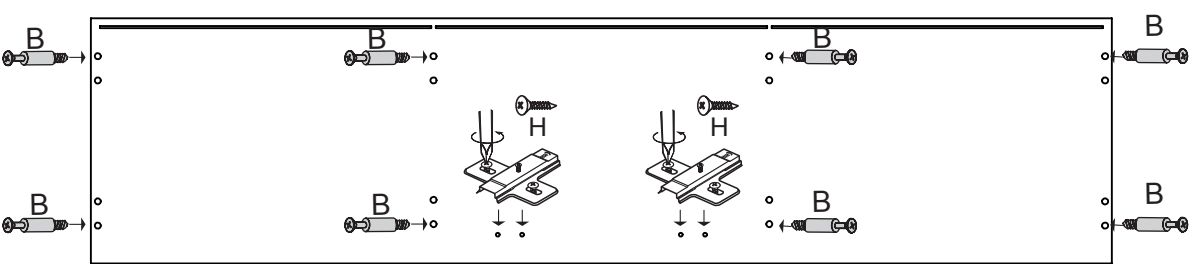

180°

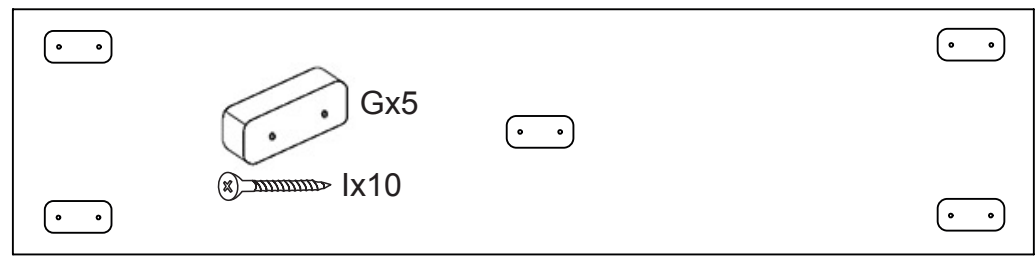

3

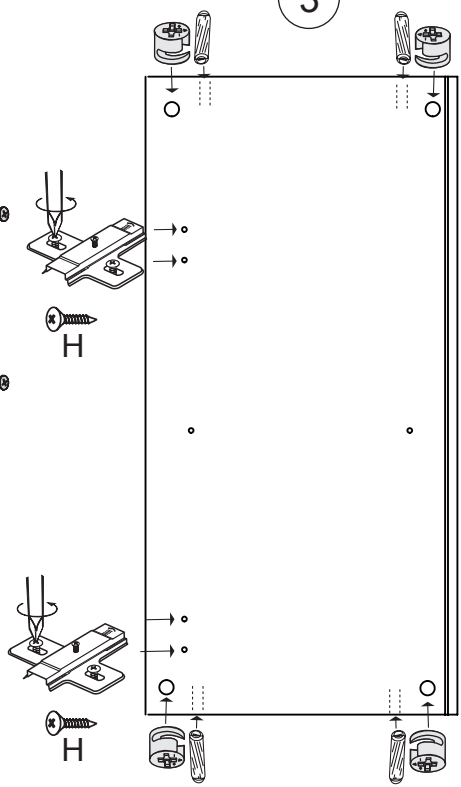

4

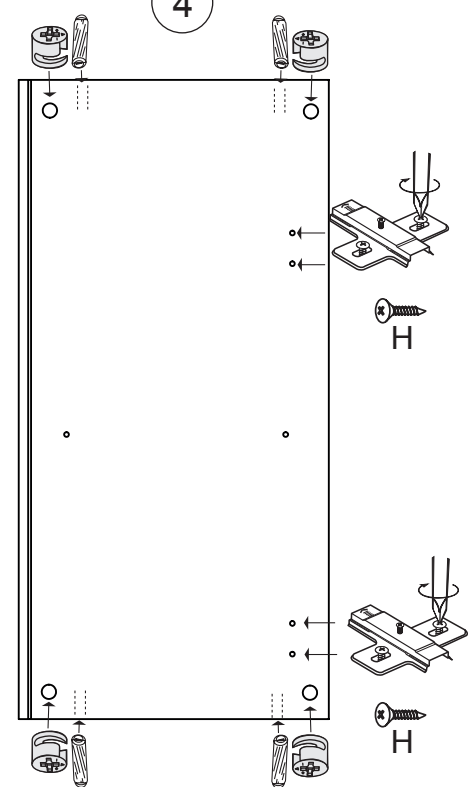

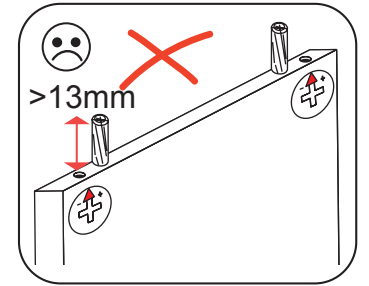
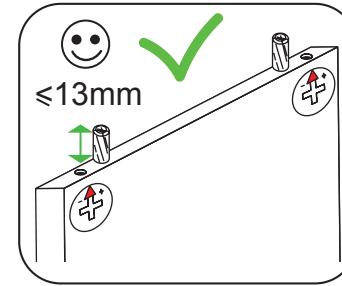
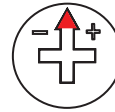
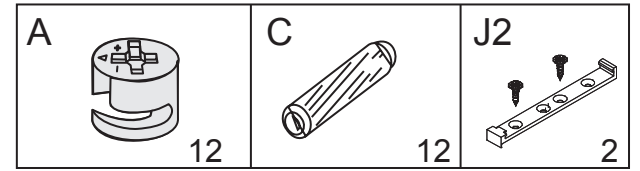
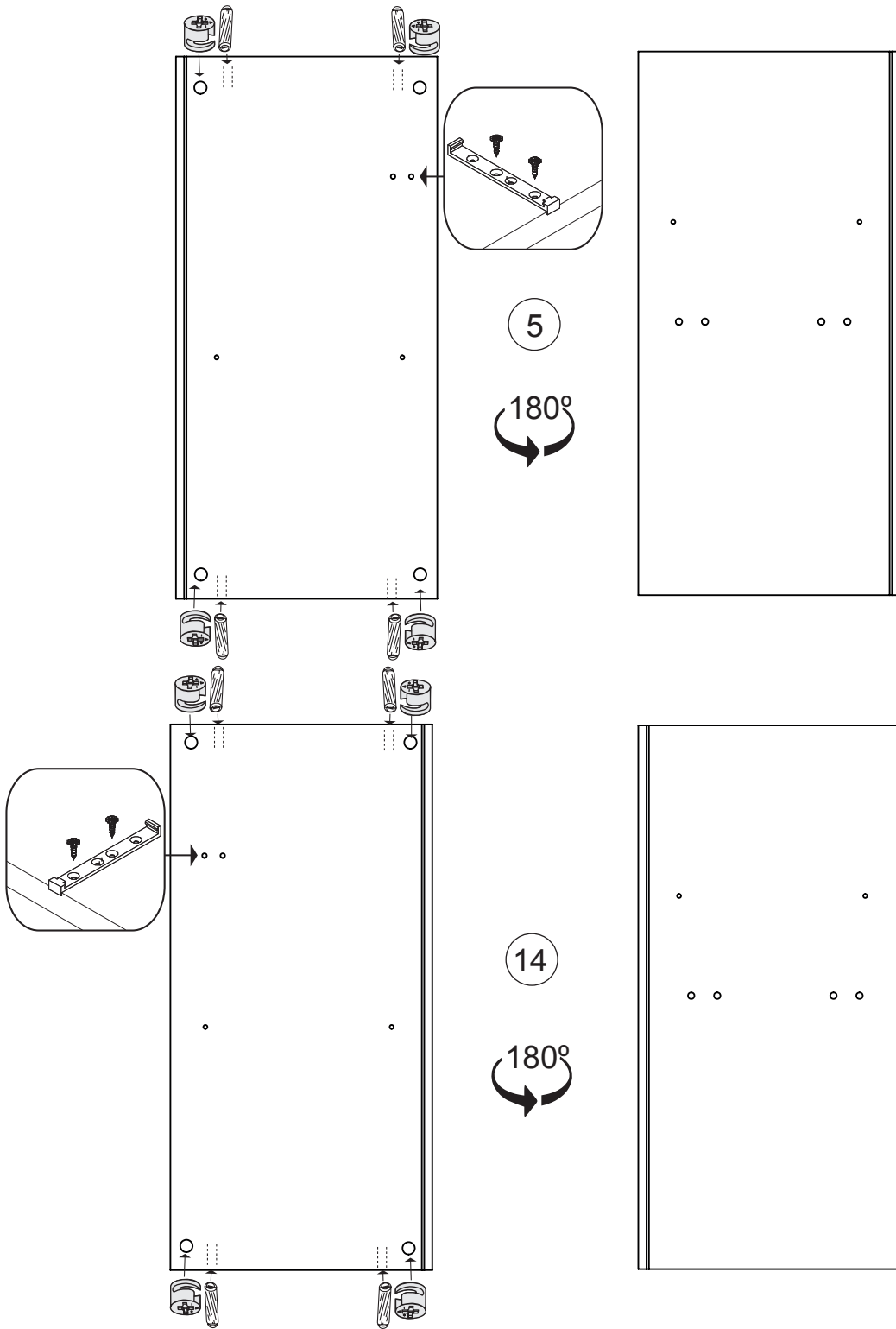

7



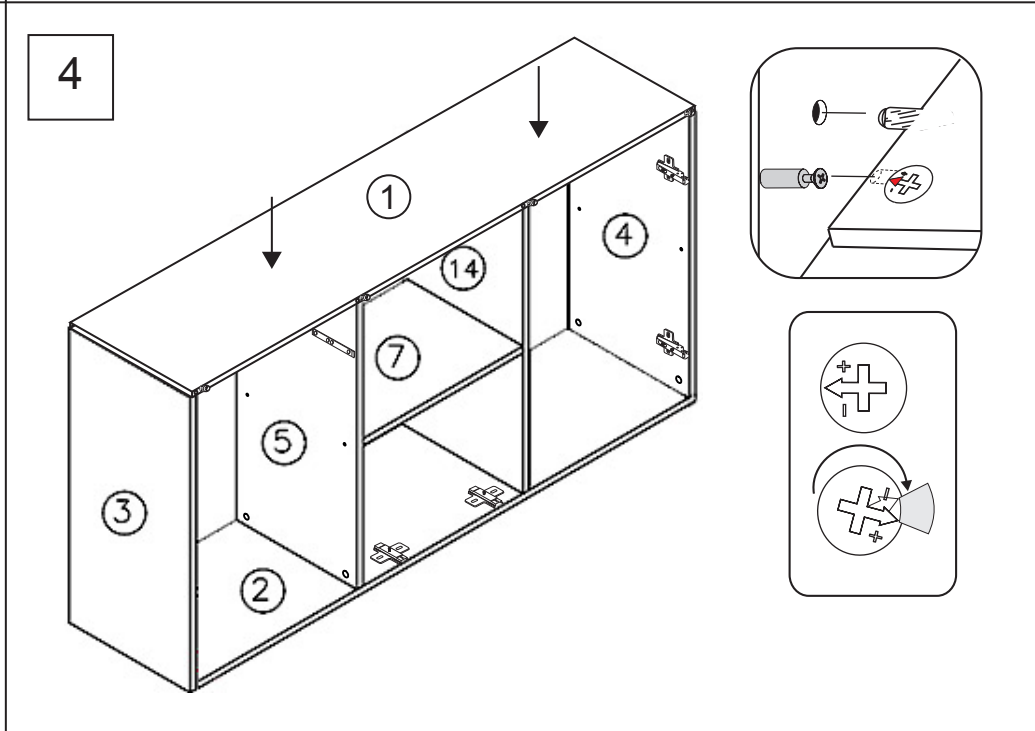
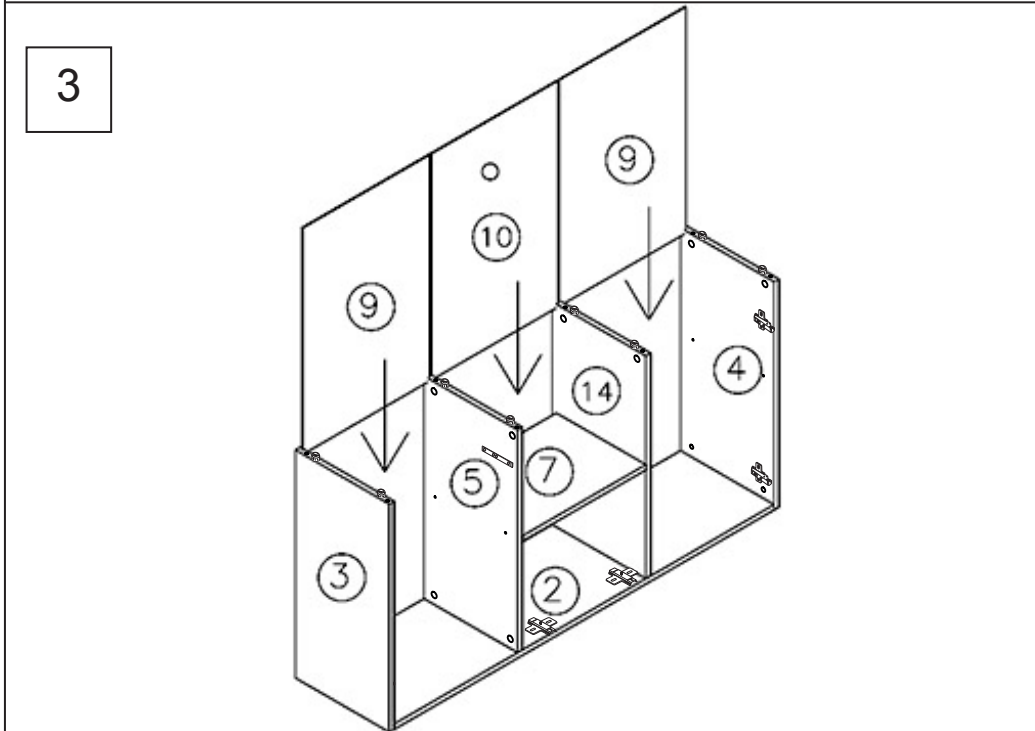
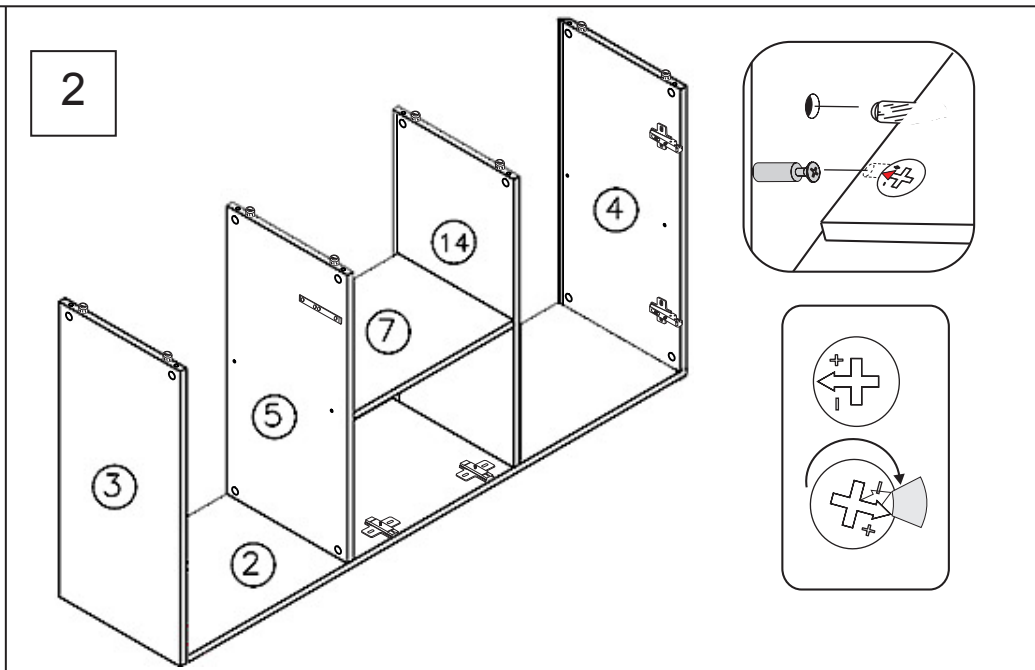
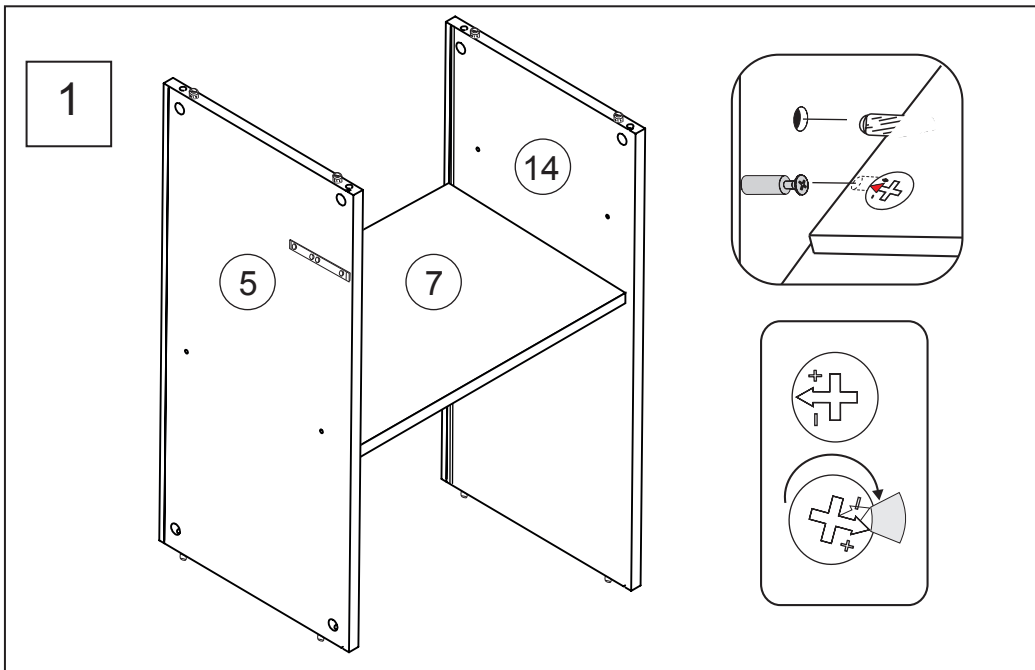

5

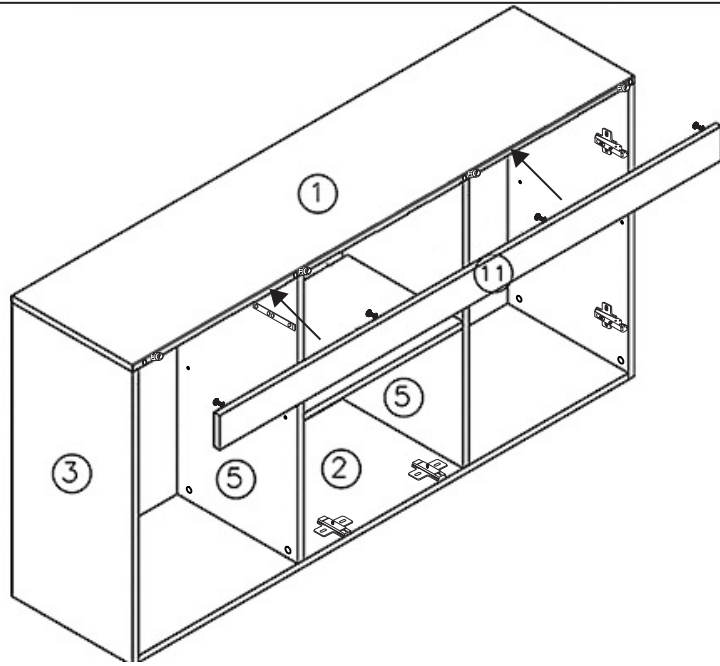

6

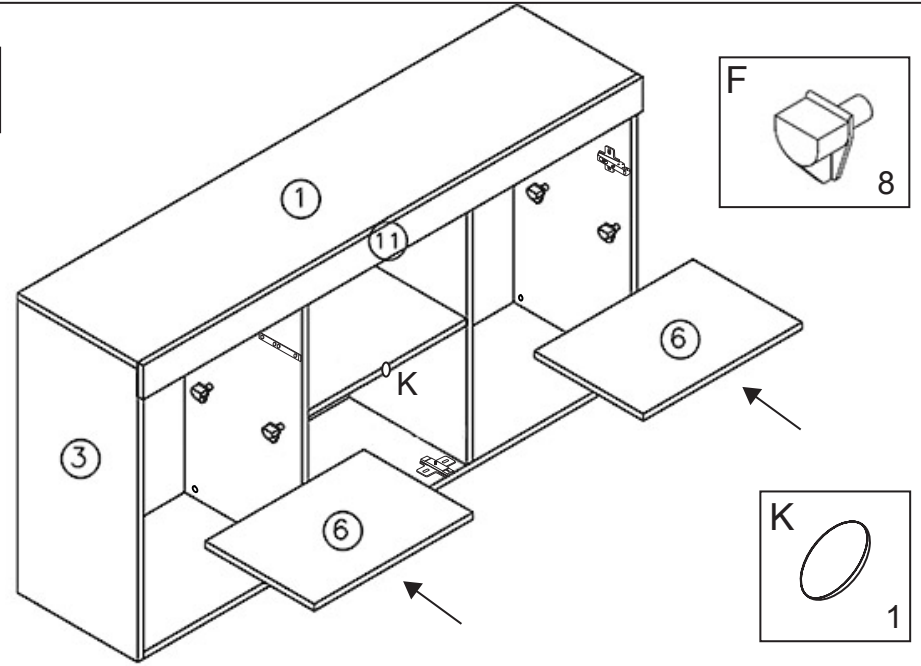

7

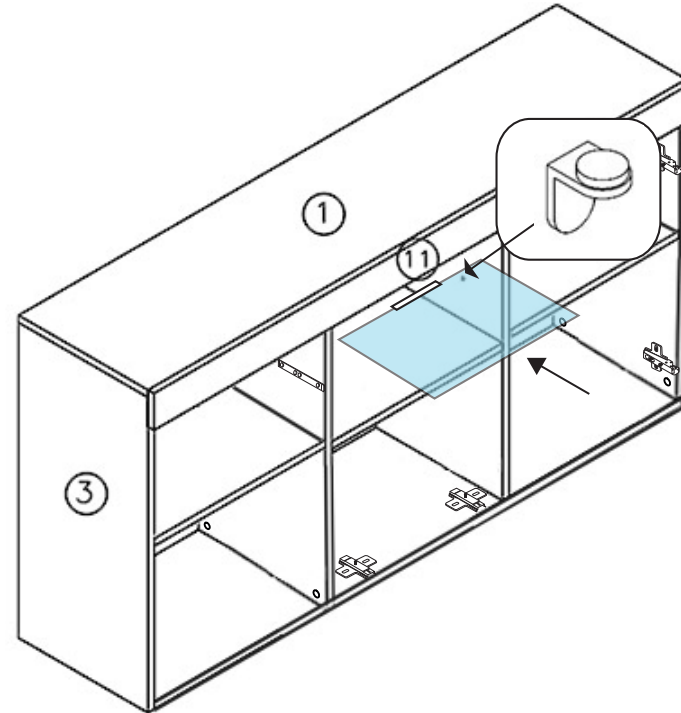
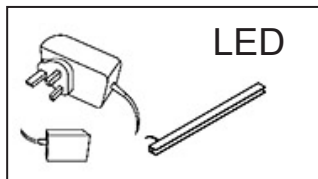
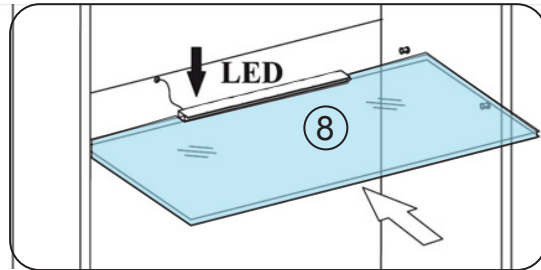

8

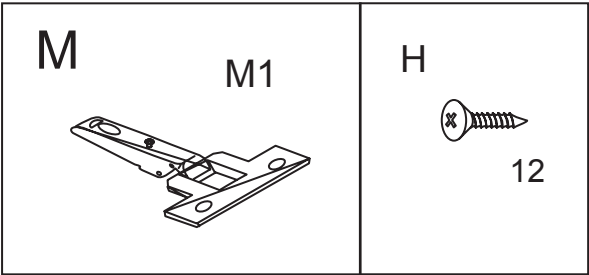
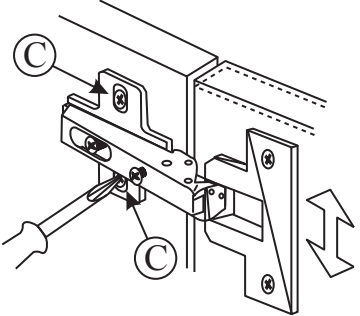
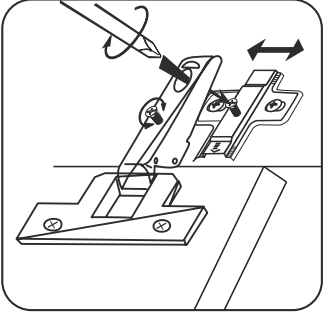
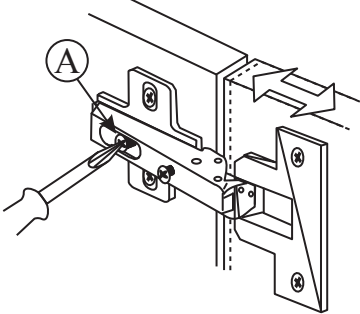
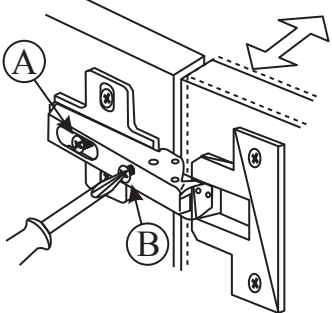
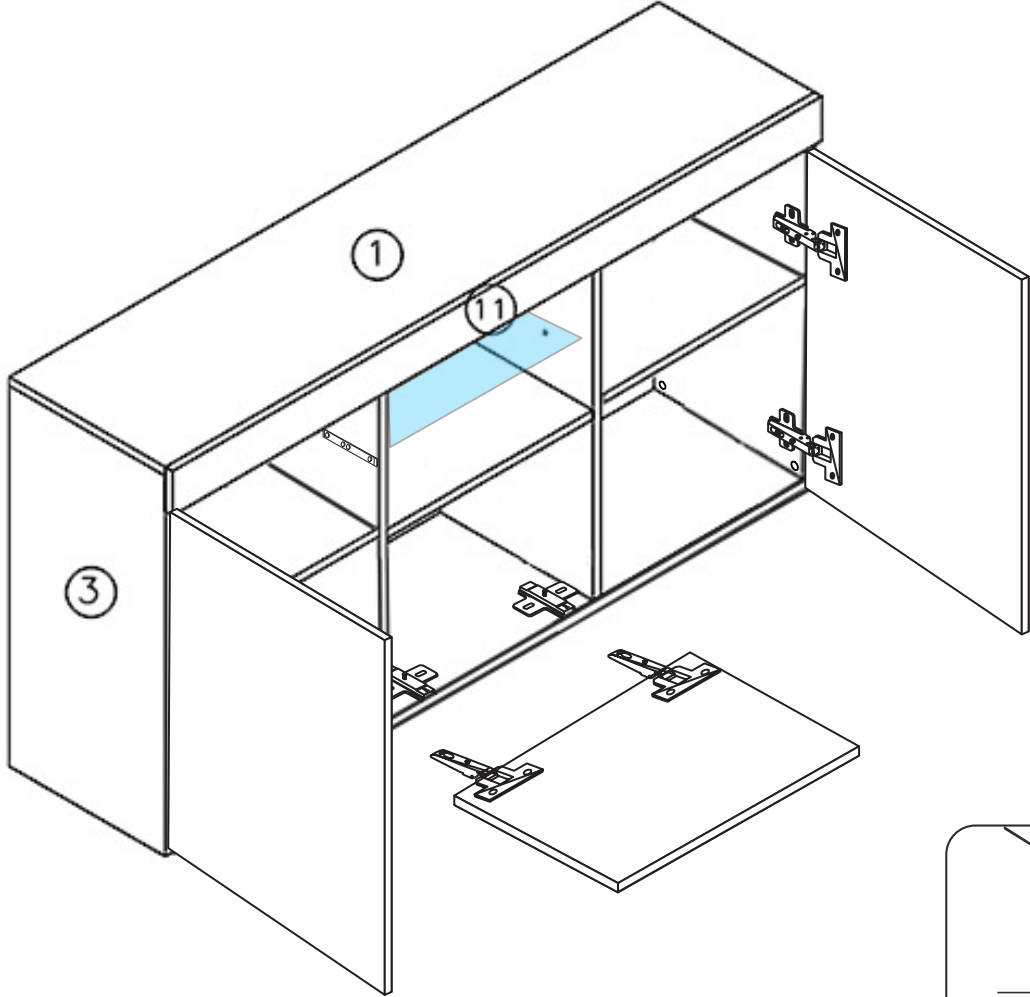

9

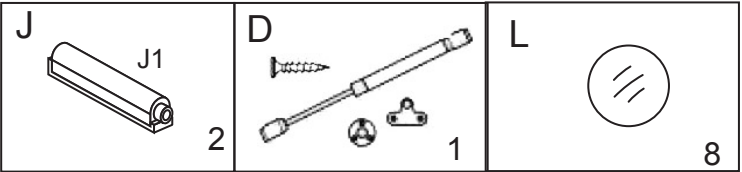
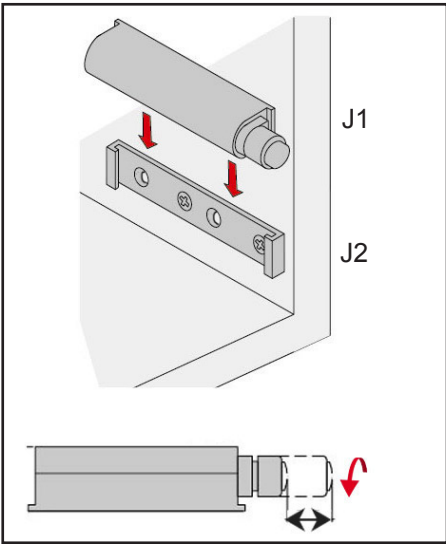
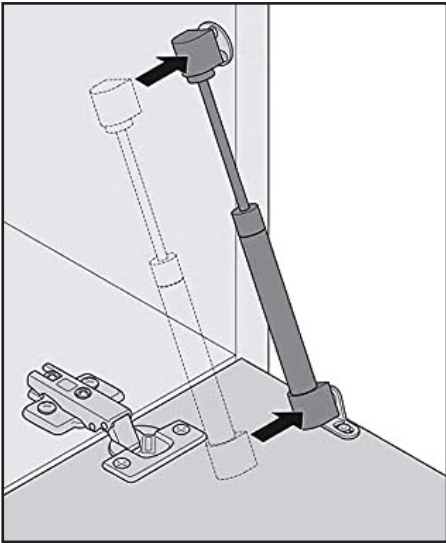
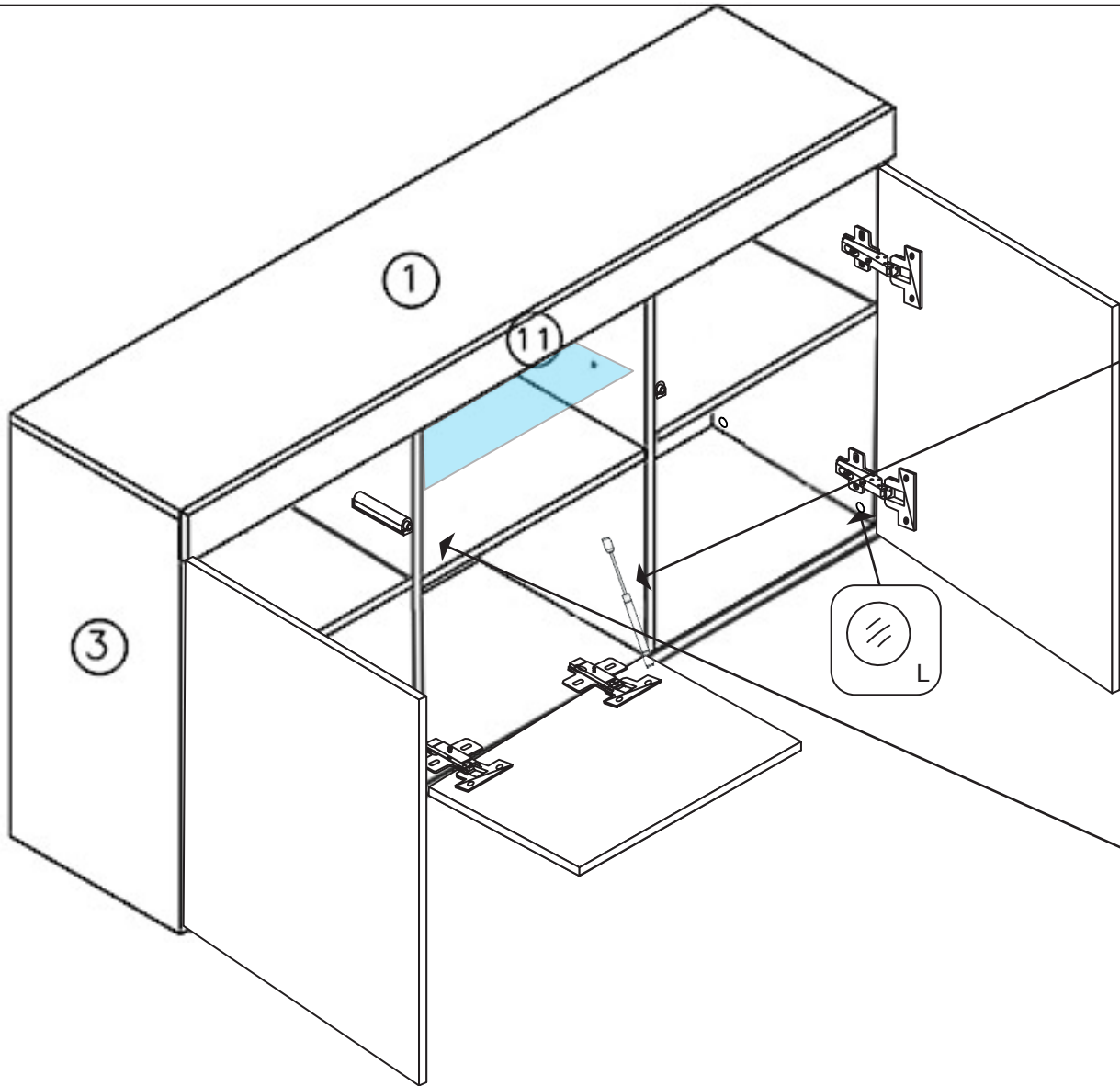

10

