

- IT Leggere il manuale d'uso. Conservare con cura le istruzioni per ogni futura consultazione.
- EN Please retain these instructions in a safe place for further reference.
- NL Bewaar deze instructies op een veilige plaats voor toekomstige raadpleging.

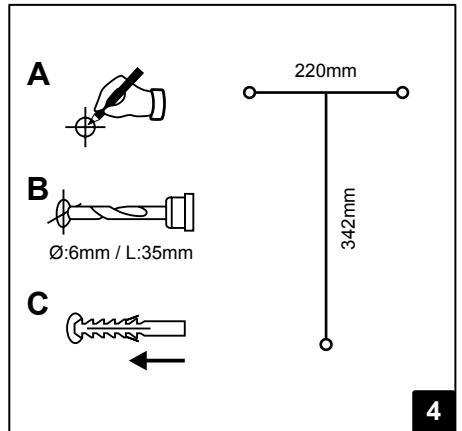

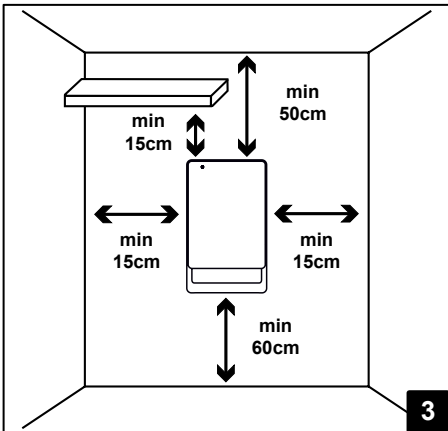
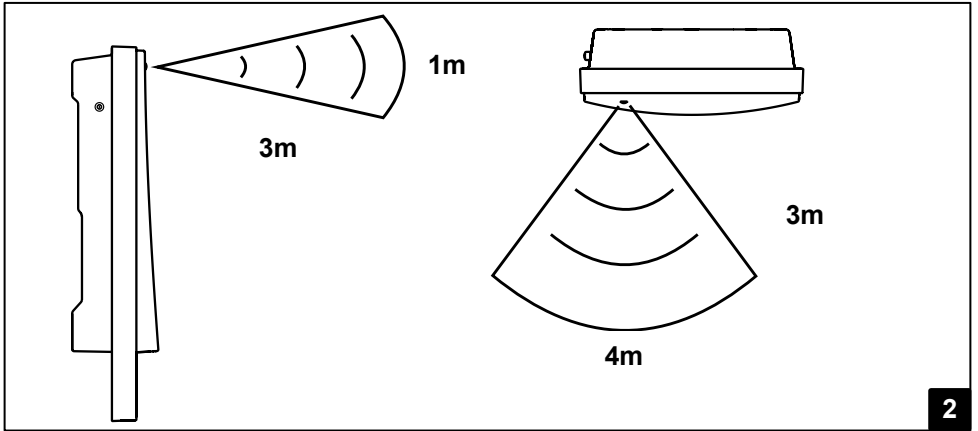
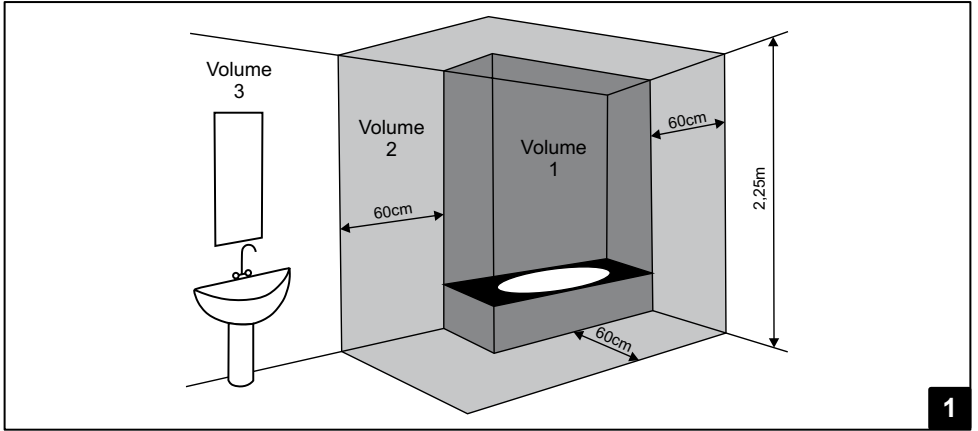
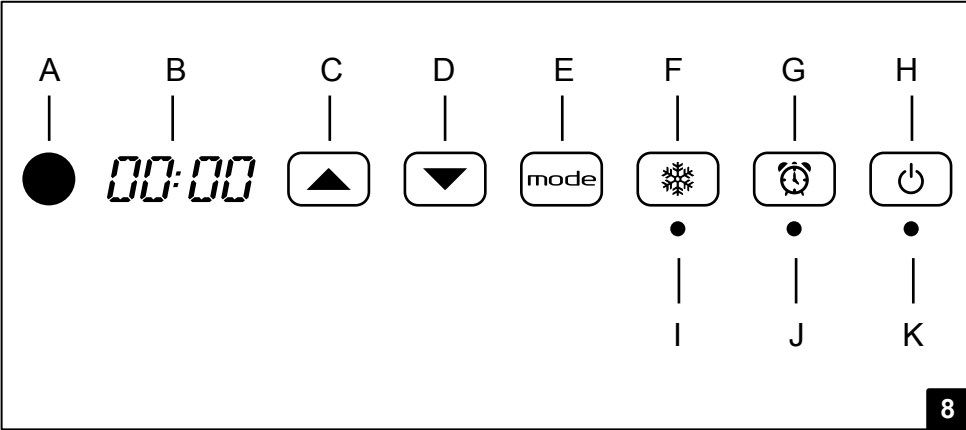
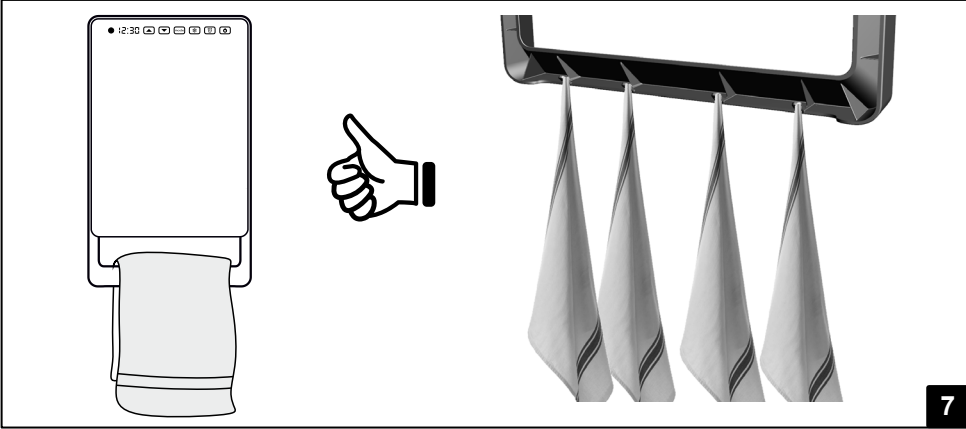
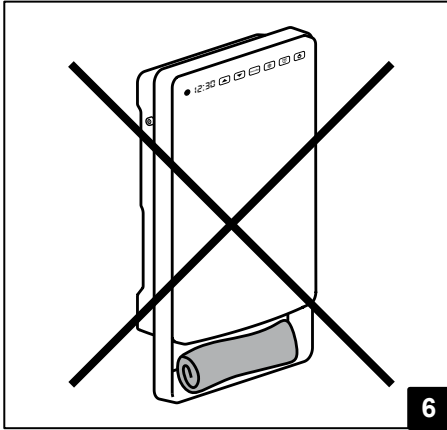
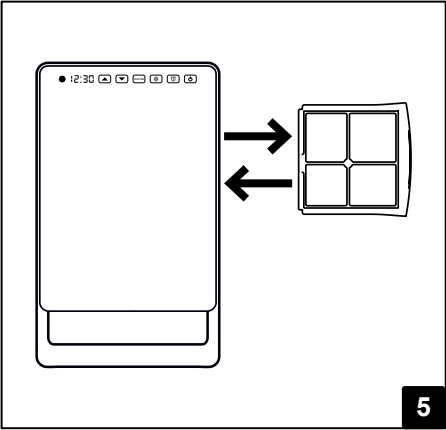

**Si prega di leggere attentamente queste istruzioni, prima di utilizzare il prodotto, in modo da evitare danneggiamenti o comunque il verificarsi di situazioni di pericolo. Qualsiasi utilizzo del prodotto diverso da quanto indicato nel presente manuale può causare incendi, pericoli elettrici o ferite e rende nulla qualsiasi garanzia.**

La garanzia non si applica ad alcun difetto, deterioramento, perdita, ferimento o danneggiamento riconducibili ad un uso non corretto del prodotto. Rimangono garantiti tutti i diritti di legge in materia. Nessuna condizione di garanzia può escludere o modificare le condizioni di garanzia regolamentate da leggi dello Stato che non possono essere a nessun titolo escluse o modificate.

Prima di ogni operazione, rimuovere con cura l'imballo e controllare la perfetta integrità del prodotto. Nel caso si evidenziasse dei difetti o danni, non installare né cercare di riparare l'apparecchiatura, ma rivolgersi al rivenditore. Non lasciare l'imballo alla portata dei bambini e smaltire le parti in conformità con le disposizioni vigenti.

## 1. PER LA VOSTRA SICUREZZA

- Questo prodotto è per uso domestico e non è adatto per l'utilizzo su veicoli, imbarcazioni o aeromobili.
- L'apparecchio può essere utilizzato da bambini di età non inferiore a 8 anni e da persone con ridotte capacità fisiche, sensoriali o mentali, o prive di esperienza o della necessaria conoscenza, purché sotto sorveglianza oppure dopo che le stesse abbiano ricevuto istruzioni relative all'uso sicuro dell'apparecchio e alla comprensione dei pericoli ad esso inerenti. I bambini non devono giocare con l'apparecchio. La pulizia e la manutenzione destinata ad essere effettuata dall'utilizzatore non deve essere effettuata da bambini senza sorveglianza.
- I bambini di età inferiore a 3 anni non devono avvicinarsi al prodotto se non costantemente supervisionati.
- I bambini di età compresa fra 3 e 8 anni possono solamente accendere e spegnere l'apparecchio purché esso sia stato installato e posizionato secondo le normali condizioni d'uso e loro siano supervisionati o adeguatamente istruiti riguardo al corretto e sicuro utilizzo del prodotto e ne abbiano compresa la pericolosità. I bambini di età compresa fra 3 e 8 anni non possono collegare il prodotto, regolarlo, pulirlo o effettuare manutenzione.
- **ATTENZIONE: Alcune parti di questo prodotto possono diventare molto calde e causare bruciate. Particolare attenzione deve essere prestata in presenza di bambini o persone vulnerabili.**
- Assicuratevi che l'alimentazione di rete corrisponda ai dati di targa: 230V~, 50Hz.

- Questo termoventilatore ha un grado di protezione IPX4 e può quindi essere utilizzato nei bagni PURCHE' NON SIA INSTALLATO ENTRO IL PERIMETRO DELLA VASCA O DELLA DOCCIA. Il prodotto non può quindi essere installato nelle aree indicate come Volume 1 nello schema di figura 1.
- Durante il funzionamento collocate il termoventilatore in una posizione sicura ovvero:
  - ad almeno 1m da oggetti infiammabili o mobili;
  - lasciando libera la griglia di uscita dell'aria: nessun oggetto deve essere presente nel raggio di 1m dalla griglia di uscita;
  - mai posizionato immediatamente sotto ad una presa di corrente.
- Non lasciate che animali o bambini giochino o tocchino il termoventilatore. Attenzione! Durante il funzionamento la griglia di uscita dell'aria può diventare molto calda (oltre 90°C);
- **IMPORTANTE: per evitare surriscaldamenti non ricoprite mai il prodotto.** Non appoggiate mai alcun oggetto o coperta sull'apparecchio mentre è in funzione. Questo è chiaramente scritto sull'apparecchio o illustrato dal simbolo



- Non utilizzate il termoventilatore in stanze saturate di gas esplosivi, di vapori generati da solventi e vernici o comunque di vapori/gas infiammabili.
- Se il cavo è danneggiato e dovete sostituirlo non eseguite questa operazione da soli, riportate il termoventilatore ad un centro di riparazioni autorizzato perché è richiesto l'intervento di personale specializzato al fine di evitare qualunque rischio di danneggiamento.
- Il termoventilatore deve essere posizionato in modo tale che la presa di alimentazione sia sempre raggiungibile.
- Non installate il prodotto su pareti di materiale sintetico.

## 2. MONTAGGIO A MURO

- Installare il termoventilatore in posizione verticale con la griglia di uscita dell'aria rivolta verso il basso.
- Questo termoventilatore è in doppio isolamento elettrico (classe II) pertanto la connessione di terra non è richiesta.
- Questo termoventilatore deve essere installato seguendo le norme in vigore nel paese di installazione.
- In ambienti umidi come bagni e cucine la connessione alla rete elettrica deve essere ad almeno 25 cm di altezza dal suolo. I dispositivi di disconnessione dalla rete di alimentazione devono consentire la disconnessione completa nelle condizioni della categoria di sovratensioni III.
- Per decidere l'installazione ideale, si tenga presente che il sensore rileva i movimenti entro l'area descritta dalla figura 2. Installate il termoventilatore nella migliore posizione che consente di rilevare le persone all'interno della stanza e avere campo libero da oggetti che possono interferire con il raggio del sensore stesso. Il rilevamento è più efficace quando le persone si muovono davanti al prodotto invece che verso di esso.
- L'apparecchio deve essere installato a muro, rispettando le distanze minime dal soffitto, dal pavimento e dalle pareti laterali indicate in figura 3. Mai installare il prodotto ad una distanza dal pavimento inferiore a 600mm:
  - Praticate nel muro 3 fori di diametro 6mm rispettando le distanze indicate in figura 4;
  - Inserite i tre tasselli forniti con il prodotto;
  - Inserite le 2 viti in alto, fornite nello stesso sacchetto, avendo cura di lasciare 8mm tra la testa della vite ed il muro;
  - Fate agganciare il prodotto alle 2 viti che avete fissato tenendolo sempre saldamente tra le mani; **ATTENZIONE!** Prima di lasciare il prodotto verificate che sia bene agganciato alle 2 viti;
  - Fissate infine il prodotto con la terza vite in basso.

## 3. FILTRO

- Il vostro prodotto è dotato di un filtro per proteggere gli elementi riscaldanti dalla polvere e dallo sporco.
- Il filtro è facilmente rimuovibile e può essere lavato con acqua (figura 5).
- Per un corretto funzionamento del prodotto consigliamo di pulire il filtro almeno una volta ogni 6 mesi **RICORDANDOSI DI INSERIRLO NUOVAMENTE NELLA SUA SEDE DOPO IL LAVAGGIO.**
- Ogni 120 ore di funzionamento l'utente viene avvisato della necessità di pulire il filtro posto sul retro del prodotto. L'avviso avviene tramite la visualizzazione a display della scritta scorrevole  
" *PULIRE FILTRO - CLEAN FILTER - NETTOYER FILTRE* ".
- Anche se il display visualizza la scritta sopra indicata il prodotto continua a funzionare nella modalità attiva al momento della comparsa dell'avviso.
- La pressione di un qualsiasi tasto cancella la scritta dal display. Essa tornerà ad essere visibile dopo un'ulteriore ora di funzionamento del termoventilatore.
- La pressione prolungata del tasto mode  con avviso attivo invece azzerà il contatore interno e l'avviso tornerà ad essere mostrato dopo ulteriori 120 ore di funzionamento. La conferma dell'avvenuto azzeramento è data dalla visualizzazione sul display per 5" della scritta *done* .

## 4. SALVIETTE

- Il prodotto integra una barra portasalviette dotata di 4 ganci aggiuntivi collocati dietro alla barra stessa.
- Le salviette devono essere posizionate correttamente sul supporto, come indicato in figura 7 e NON come indicato in figura 6, per evitare surriscaldamenti e malfunzionamenti.

## 5. DESCRIZIONE DEI COMANDI E DEL FUNZIONAMENTO

- Il termoventilatore è dotato di un pulsante di accensione e spegnimento posto sul fianco sinistro. Spegnendo il prodotto i componenti elettrici interni non saranno più sotto tensione.
- I seguenti controlli sono integrati sul frontale del prodotto (figura 8):
  - A - Sensore di presenza
  - B - Display
  - C - Mostra e aumenta
  - D - Mostra e diminuisce
  - E - Impostazioni
  - F - Funzione antigelo
  - G - Programmazione
  - H - Stand-by
  - I - Indicatore led modalità antigelo
  - J - Indicatore led modalità programmata
  - K - Indicatore led di funzionamento

Questo termoventilatore incorpora un sensore di presenza e un sistema di gestione automatica della potenza.

Il sensore di presenza permette una riduzione del consumo energetico abbassando automaticamente la temperatura ambiente quando il locale non è occupato per almeno 10 minuti. Il ritorno alla temperatura di Comfort avviene automaticamente non appena viene nuovamente rilevata una presenza.

Il selettore automatico di potenza invece permette una gestione ottimale dei consumi ed una regolazione precisa del livello di comfort mantenendo automaticamente la temperatura selezionata costante nel tempo, in accordo con quanto è stato impostato sul termostato elettronico.

Il funzionamento del sensore di presenza non può essere disabilitato e il prodotto può essere fatto funzionare in 2 distinte modalità: automatica o programmata.

### **Modalità Automatica**

Il prodotto è impostato per funzionare ad una temperatura Comfort ogni qualvolta qualcuno venga rilevato nella stanza. In caso di mancato rilevamento di qualsiasi presenza per più di 10 minuti, il termoventilatore imposta automaticamente la temperatura Eco (3,5°C meno della temperatura Comfort impostata). Se il mancato rilevamento di presenza dovesse protrarsi per più di 36 ore, il termoventilatore imposta automaticamente la funzione Antigelo (7°C). In caso il prodotto dovesse rilevare una presenza per un tempo di almeno 2 minuti, il termoventilatore riporta automaticamente la temperatura al livello di comfort impostato.

In modalità automatica è inoltre disponibile una speciale funzione, attivabile a scelta dell'utente, che permette di rilevare l'eventuale apertura di una finestra e forzare il funzionamento in modalità Antigelo per limitare al massimo lo spreco di energia.

### **Modalità Programmata**

Il prodotto può essere programmato, su base oraria, per ogni giorno della settimana. Per ogni ora di ogni giorno infatti è possibile definire la temperatura di riferimento da raggiungere/mantenere scegliendo fra le temperature di Comfort, Eco o Antigelo.



Per tutto il tempo di funzionamento in modalità programmata il sensore di presenza e il rilevamento dell'apertura di una finestra vengono disattivati affinché il prodotto possa correttamente seguire il profilo di temperatura impostato dall'utente.

## 6. COLORI DELLA LUCE LED

- Ci sono 3 diverse luci led sul prodotto:
- Luce led sotto il pulsante Antigelo (figura 8-I)
  - Il led è rosso quando la funzione antigelo è attivata. Risulta spento quando la funzione antigelo è disattivata.
  - Lampeggia quando la funzione è stata attivata in seguito al rilevamento dell'apertura di una finestra.
- Luce led sotto il pulsante Programmazione (figura 8-J)
  - La luce è rossa quando la modalità Programmata è attivata. Risulta spento quando la modalità Programmata è disattivata.
- Luce led sotto il pulsante Stand-by (figura 8-K)
  - La luce è rossa quando il prodotto sta funzionando in modalità Comfort;
  - La luce è verde quando il prodotto sta funzionando in modalità Eco;
  - La luce è spenta quando il prodotto è in Stand-by.

## 7. UTILIZZO DEL TERMOVENTILATORE

### PULSANTE DI ACCENSIONE/SPEGNIMENTO (situato sul lato sinistro del prodotto)

L'alimentazione del prodotto è controllata tramite un pulsante elettromeccanico di accensione e spegnimento. Spegnere il prodotto tramite questo pulsante causa l'interruzione di alimentazione della scheda elettronica provocando, dopo 30 minuti di interruzione, la perdita delle impostazioni immesse. Raccomandiamo di utilizzare questo pulsante in caso non si debba usare il prodotto per un periodo prolungato di tempo e di utilizzare invece il controllo frontale di Accensione / Stand-by, in caso di breve interruzione di utilizzo del prodotto, in modo da non perdere le impostazioni di regolazione precedentemente immesse.

Al primo utilizzo del prodotto, o in caso di mancata alimentazione per un periodo superiore a 30 minuti, quando viene acceso il termoventilatore sul display compare l'indicazione 00:00 e l'orologio inizia a contare il tempo.



In caso non venga immessa nessuna impostazione entro 15 minuti dall'accensione, il prodotto imposta automaticamente la funzione Antigelo, accendendo il led corrispondente.

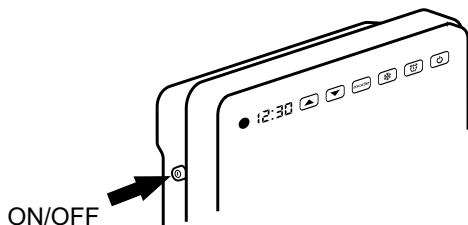

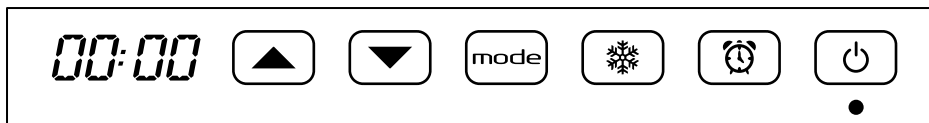
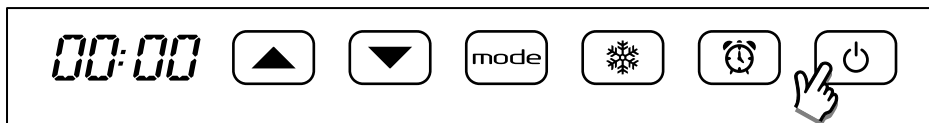

### PULSANTE STAND-BY

Usare il pulsante  per accendere o mettere in Stand-by il prodotto. Il led corrispondente sotto il pulsante si accende di colore verde.



### IMPOSTAZIONI

I pulsanti ,  e , permettono di impostare l'ora e il giorno correnti, la temperatura di Comfort e di attivare o disattivare il rilevamento dell'apertura di una finestra. Il giorno "1" corrisponde al LUNEDÌ.

Es.: Per impostare le ore 08:30, il giorno "martedì", una temperatura Comfort di 25°C e abilitare il rilevamento della finestra aperta precedentemente disabilitato, procedere come segue:

Attivare la visualizzazione/modifica premendo il tasto  per almeno 3 secondi:

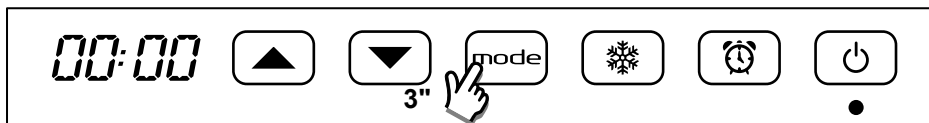



### Regolazione dell'orario

Le 2 cifre dell'ora lampeggiano: selezionare l'ora corrente usando i tasti ▲ e ▼

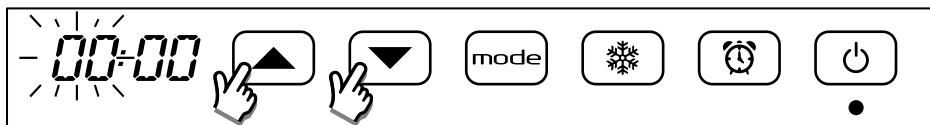

Premere il tasto **mode** per confermare

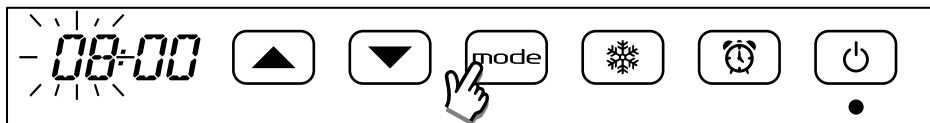

Le 2 cifre dei minuti lampeggiano: selezionare i minuti correnti usando i tasti ▲ e ▼

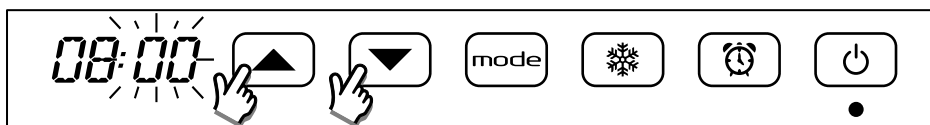

Premere il tasto **mode** per confermare

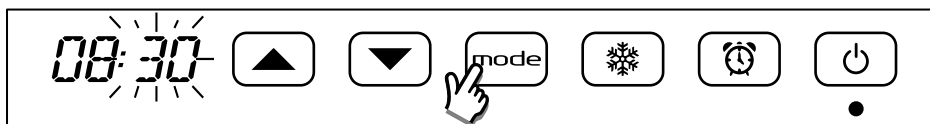

### Regolazione del giorno della settimana (1 = lunedì)

Dopo aver confermato i minuti correnti, il giorno della settimana inizia a lampeggiare: selezionare il giorno corrente usando i tasti ▲ e ▼

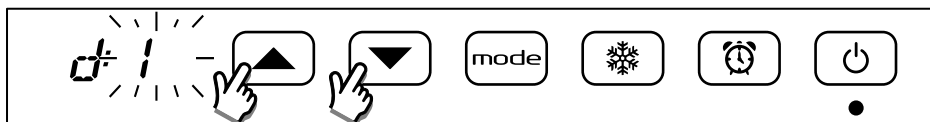

Premere il tasto **mode** per confermare

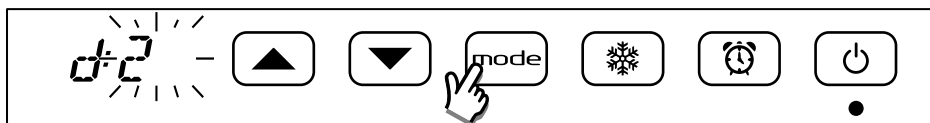

### Regolazione della temperatura di Comfort (Eco = Comfort - 3,5°C)

Dopo aver confermato il giorno corrente, la temperatura di Comfort inizia a lampeggiare: selezionare la temperatura desiderata usando i tasti ▲ e ▼

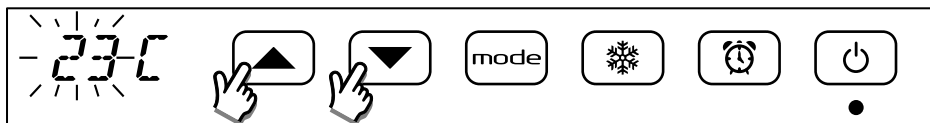

Premere il tasto  per confermare

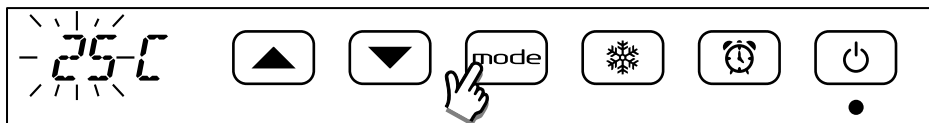

### SENSORE FINESTRA APERTA

Questa funzione permette di identificare l'apertura di una finestra e di impostare automaticamente il modo di funzionamento Antigelo. L'accensione di un punto rosso nella parte alta del display fra la terza e la quarta cifra, indica che la funzione è abilitata e pronta ad attivare la modalità antigelo qualora venga rilevata l'apertura di una finestra.





Qualora venga rilevata una brusca riduzione della temperatura durante il normale funzionamento del prodotto, viene attivata automaticamente la modalità antigelo per ridurre lo spreco di energia. Il led rosso in corrispondenza del tasto antigelo lampeggia per indicare l'attivazione della funzione.

Il ripristino del normale funzionamento non è automatico ma si ottiene premendo uno qualsiasi dei 5 tasti del prodotto.



Il corretto funzionamento di questa funzione può dipendere dal posizionamento del prodotto del locale, dalla presenza di spifferi, dalla temperatura esterna e dal tempo di apertura della finestra.

### Attivazione della funzione di rilevamento della finestra aperta

Dopo aver confermato il valore della temperatura di Comfort, la modalità di identificazione della finestra aperta inizia a lampeggiare. Il display indica 88:on se la funzione è attiva e 88:of se è disattiva. Selezionare il modo desiderato usando i tasti  e .

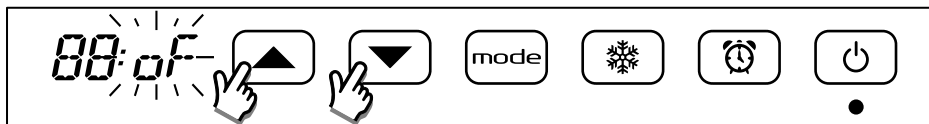

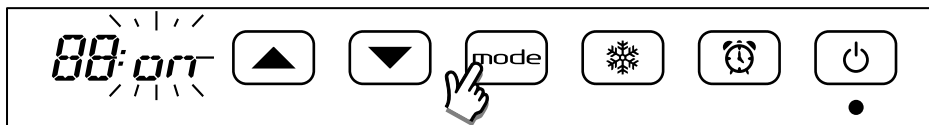

Premere il tasto  per confermare



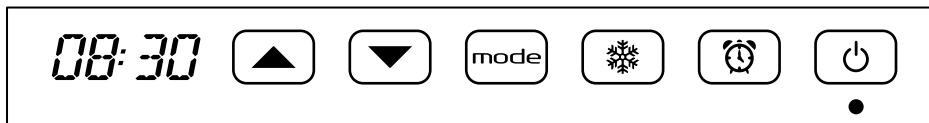

Fine delle impostazioni:



### VISUALIZZARE / MODIFICARE LA TEMPERATURA COMFORT

Potete controllare la temperatura Comfort preimpostata, in qualsiasi momento, premendo una sola volta i tasti  o . Ogni ulteriore successiva pressione cambierà la temperatura impostata.

Quando il prodotto è in modalità Eco, premendo il tasto  il termoventilatore inizierà automaticamente a funzionare in modalità Comfort, senza dover aspettare che il sensore di presenza rilevi la vostra presenza all'interno della stanza per almeno 2 minuti

In caso si desideri visualizzare o modificare il livello di temperatura Comfort senza abbandonare la modalità Eco, basterà premere prima una sola volta il tasto . La modalità Eco rimarrà sempre indicata tramite la luce led verde

accesa.

**NOTA:** La temperatura misurata tramite il sensore interno al prodotto indica sempre la temperatura ambiente nelle immediate vicinanze del prodotto e potrebbe differire dalla temperatura misurata con altri strumenti in altre aree della stanza. Questa differenza può dipendere da vari fattori, come ad esempio:

- La posizione dell'installazione: alcune aree della stanza possono risentire di correnti o sacche d'aria calda che possono modificare la misurazione del sensore;
- L'installazione su un muro perimetrale esterno, che essendo normalmente più freddo dei muri interni, può provocare una misurazione più bassa della temperatura rispetto alla temperatura ambiente reale;
- Un carico eccessivo di salviette sulla barra di supporto può ostruire il flusso d'aria calda, provocando una misurazione della temperatura più alta rispetto alla reale temperatura;
- Condizioni instabili: ogni valutazione deve essere fatta in condizioni stabili di funzionamento. Per questo motivo la temperatura Comfort non dovrebbe essere cambiata prima che siano trascorsi 60 minuti dalla precedente modifica. Non è possibile infatti valutare se la temperatura ambiente è mantenuta correttamente dal prodotto se il livello di temperatura è continuamente modificato in un breve periodo di tempo.

Se la differenza tra la temperature impostata e la temperature ambiente è rilevata in condizioni di stabilità, calcolate tale differenza e quindi aumentate o diminuite il livello di temperature Comfort sul prodotto dell'esatto valore della differenza calcolata.

### PROGRAMMAZIONE SETTIMANALE

La modalità Programmata  permette di impostare, per ogni ora del giorno e per tutti i giorni della settimana in modo indipendente, la temperatura desiderata scegliendo fra quella di Comfort, quella di Eco (pari a quella di Comfort ridotta di 3,5°C) o quella di Antigelo.

La semplice pressione del tasto  permette di attivare/disattivare il funzionamento programmato. La sua pressione prolungata invece permette di accedere alla visualizzazione/modifica del programma di funzionamento. Se il prodotto è nuovo il profilo predefinito per il programma è il seguente:

Sempre Antigelo con attivazione della modalità comfort:

- dalle 06:00 alle 08:00 dal lunedì al venerdì;
- dalle 08:00 alle 10:00 il sabato e la domenica.



*Premete il tasto dedicato per attivare immediatamente e senza pensieri la programmazione!*

Per visualizzare/modificare il programma procedere come segue:

Attivare la visualizzazione/modifica premendo il tasto  per almeno 3 secondi:

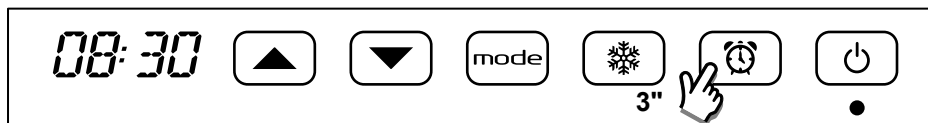

Il display visualizza il giorno 1 (lunedì). Premendo i tasti  e  si visualizzano le diverse ore del giorno iniziando da "00" (ora compresa fra le ore 00:00 e le 00:59):

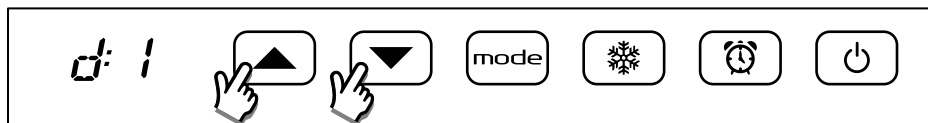

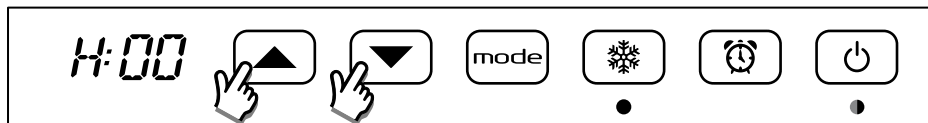

La temperatura di riferimento impostata per la fascia oraria selezionata è indicata dall'accensione del led antigelo (temperatura di 7°C), del led di funzionamento di colore verde (temperatura Eco = Comfort - 3,5°C) o del led di funzionamento di colore rosso (temperatura Comfort impostata dall'utente):



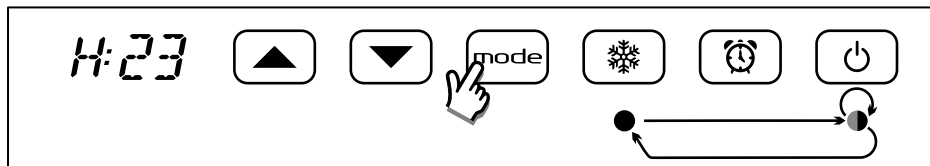

La temperatura di riferimento desiderata può essere modificata premendo il tasto . L'accensione in sequenza dei led sopra indicati indica la temperatura di riferimento:



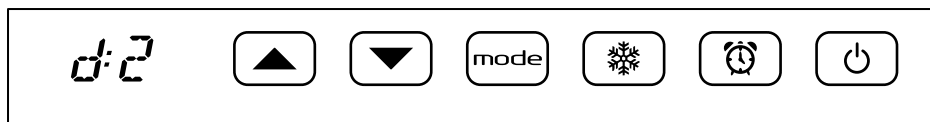
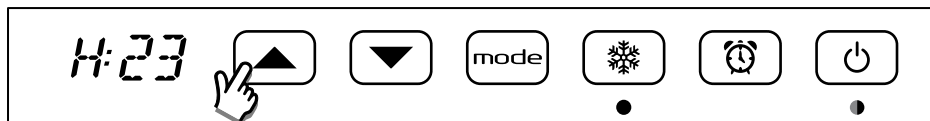

Usare i tasti  e  per visualizzare/modificare la temperatura impostata per ognuna delle ore del giorno 1. Giunti alle ore 23, la successiva pressione del tasto  permette di accedere alla programmazione del giorno 2:

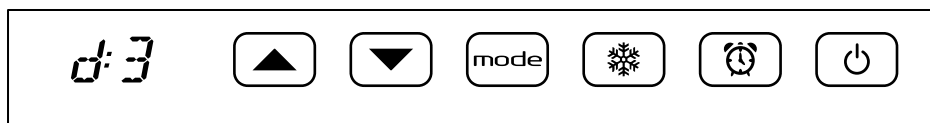
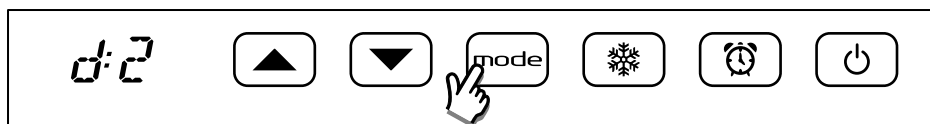

A questo punto è possibile scegliere se visualizzare/modificare la temperatura delle singole ore del giorno 2 oppure impostare il giorno 2 identico al giorno 1. Nel primo caso, usare i tasti  e  come già illustrato per il giorno 1, nel secondo è sufficiente premere nuovamente il tasto . Così facendo il giorno 2 viene posto automaticamente uguale al giorno 1 e il sistema si porta all'inizio del giorno 3. Questa procedura può essere ripetuta fino alla programmazione del giorno 7:



Al termine della programmazione del giorno 7, oppure in qualsiasi fase intermedia della programmazione in seguito alla pressione del tasto , si accede alla fase di conferma e salvataggio del programma. Sul display appare la scritta "End" e con la successiva pressione del tasto  si memorizza il programma appena definito:

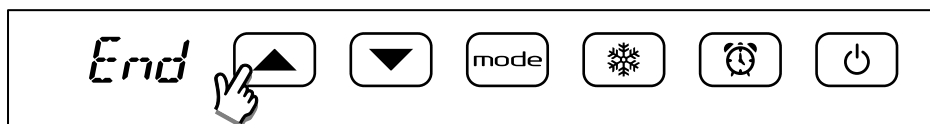

La visualizzazione sul display della scritta "donE" per alcuni secondi conferma che la procedura si è conclusa correttamente. Il prodotto si porta nello stato di funzionamento programmato per l'ora ed il giorno correnti.

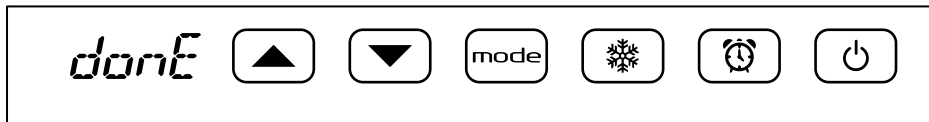

**Nota bene:**



- In ogni momento è possibile abbandonare la procedura di visualizzazione/modifica cancellando le modifiche non ancora salvate premendo il tasto stand-by;
- Durante la programmazione gli elementi riscaldanti vengono disattivati ed il radiatore non scalda.

**MODALITÀ ANTIGELO**

Per attivare la modalità Antigelo premete il pulsante per 3". Il termostato viene in questo modo impostato per mantenere  $7^{\circ}\pm 3^{\circ}\text{C}$ . Per disattivare la funzione Antigelo è sufficiente premere il pulsante o .



La modalità Antigelo si attiva automaticamente quando non viene rilevata alcuna presenza per almeno 36 ore. In questo caso, non appena verrà nuovamente rilevata una presenza, il prodotto imposterà automaticamente la modalità automatica con temperatura Comfort.

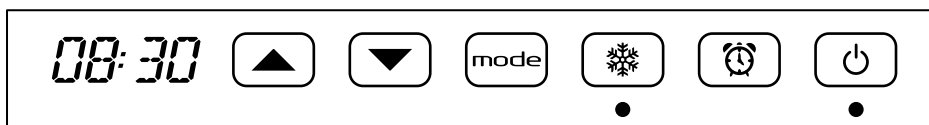
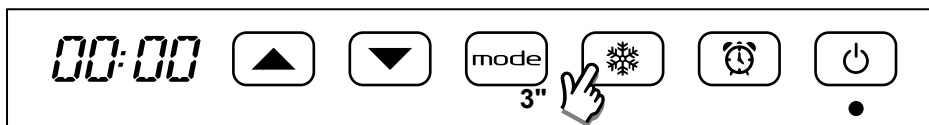

## 8. RISOLUZIONE DEI PROBLEMI

- In caso di surriscaldamento, il protettore di sicurezza all'interno del prodotto disattiva sia la resistenza che il motore. In questo caso:
  - Spegner il termoventilatore e lasciarlo raffreddare per circa 15/20 minuti;
  - Assicurarsi che il filtro antipolvere non sia ostruito e pulire se necessario. Ricordarsi di ricollocarlo nella sua posizione originaria prima di riattivare il prodotto;
  - Eliminare ogni possibile causa di surriscaldamento (es.: ostruzioni in corrispondenza della griglia di uscita dell'aria, residui di sporcizia sul prodotto);
  - Riaccendere il termoventilatore e controllare il corretto funzionamento.
- Se i comandi touch screen del prodotto non rispondono alla pressione digitale o non funzionano correttamente, spegnere il termoventilatore per almeno 10 secondi tramite l'interruttore elettromeccanico posto sul lato sinistro del prodotto.

## 9. MANUTENZIONE

- Questo prodotto non richiede manutenzione speciale.
- Pulire il prodotto con un panno asciutto almeno una volta ogni 6 mesi.
- In caso il prodotto debba essere riparato, rivolgersi ad un centro di assistenza qualificato.
- In caso di sostituzione del cavo di alimentazione, utilizzare un tipo 2x1,00mm<sup>2</sup> H05VV-F <HAR>. Tale sostituzione deve essere effettuata da personale tecnico qualificato e mai dall'utente finale per evitare un danneggiamento del prodotto e ogni rischio per la persona.

## 10. COMUNICAZIONI DI LEGGE



### Tutela dell'ambiente e riciclaggio

Affinché il vostro apparecchio non subisca danni durante il trasporto, esso è stato imballato con cura. Per contribuire alla tutela del nostro ambiente, vi chiediamo di smaltire in modo appropriato il materiale utilizzato per l'imballaggio dell'apparecchio.

### Smaltimento degli apparecchi usati

Gli apparecchi che recano il contrassegno riportato a fianco non devono essere smaltiti insieme ai rifiuti urbani, ma vanno raccolti e smaltiti separatamente. Lo smaltimento degli apparecchi usati va eseguito a regola d'arte, in conformità con le prescrizioni e leggi vigenti localmente in materia.

### Informazioni obbligatorie per gli apparecchi per il riscaldamento d'ambiente locale elettrici

Identificativo del modello: TOUCH					
Dato	Simbolo	Valore	Unità	Dato	Unità
<b>Potenza termica</b>				<b>Tipo di potenza termica, solo per gli apparecchi per il riscaldamento d'ambiente locale elettrici ad accumulo (indicare una sola opzione)</b>	
Potenza termica nominale	$P_{nom}$	1,8	kW	controllo manuale del carico termico, con termostato integrato	no
Potenza termica minima (indicativa)	$P_{min}$	1,0	kW	controllo manuale del carico termico con riscontro della temperatura ambiente e/o esterna	no
Massima potenza termica continua	$P_{max,c}$	1,8	kW	controllo elettronico del carico termico con riscontro della temperatura ambiente e/o esterna	no
<b>Consumo ausiliario di energia elettrica</b>				potenza termica assistita da ventilatore	no
Alla potenza termica nominale	$eI_{max}$	1,800	kW	<b>Tipo di potenza termica/controllo della temperatura ambiente (indicare una sola opzione)</b>	
Alla potenza termica minima	$eI_{min}$	1,000	kW	potenza termica a fase unica senza controllo della temperatura ambiente	no
In modo stand-by	$eI_{SB}$	0,00076	kW	due o più fasi manuali senza controllo della temperatura ambiente	no
				con controllo della temperatura ambiente tramite termostato meccanico	no
				con controllo elettronico della temperatura ambiente	no
				con controllo elettronico della temperatura ambiente e temporizzatore giornaliero	no
				con controllo elettronico della temperatura ambiente e temporizzatore settimanale	si
				<b>Altre opzioni di controllo (è possibile selezionare più opzioni)</b>	
				controllo della temperatura ambiente con rilevamento di presenza	si
				controllo della temperatura ambiente con rilevamento di finestre aperte	si
				con opzione di controllo a distanza	no
				con controlli di avviamento adattabile	no
				con limitazione del tempo di funzionamento	no
				con termometro a globo nero	no
Contatti	Vedere dettagli sulla targa dati del prodotto				

**Before operating the heater, please read these instructions thoroughly to avoid damage and hazardous situations. Any use of this heater other than that stipulated in this instruction manual may cause fire, electric shock or injury, and voids all warranties.**

Warranty does not apply to any defect, deterioration, loss, injury or damage caused by, or as a result of, the misuse or abuse of this heater. The rights dictated by State law are not prejudiced. None of the terms of this warranty are to be taken as excluding any conditions or warranties implied by State law, which cannot be excluded or modified.

Before any operation remove the packaging and check product integrity. In case of defects or damages do not try to repair it yourself but contact your dealer.

Do not let children play with the packaging and protect the environment by disposing of the packaging in accordance with the national regulations for waste processing.

## 1. FOR YOUR SAFETY

- This appliance is intended for normal household use and not for use in vehicles or on board ships or aircrafts.
- This appliance can be used by children aged from 8 years and above and persons with reduced physical, sensory or mental capabilities or lack of experience and knowledge if they have been given supervision or instruction concerning use of the appliance in a safe way and understand the hazards involved. Children shall not play with the appliance. Cleaning and user maintenance shall not be made by children without supervision.
- Children of less than 3 years should be kept away unless continuously supervised.
- Children aged from 3 years and less than 8 years shall only switch on/off the appliance provided that it has been placed or installed in its intended normal operating position and they have been given supervision or instruction concerning use of the appliance in a safe way and understand the hazards involved. Children aged from 3 years and less than 8 years shall not plug in, regulate and clean the appliance or perform user maintenance.
- **CAUTION — Some parts of this product can become very hot and cause burns. Particular attention has to be given where children and vulnerable people are present.**
- Make sure that your supply rating corresponds to what specified on the rating plate: 230V~, 50Hz.
- This heater is water resistant to IPX4. It can therefore be used in bathrooms or other areas subject to humidity AS LONG AS IT IS NOT INSTALLED WITHIN THE PERIMETER OF BATH TUBS

OR SHOWERS. This means that it cannot be installed in the areas marked as VOLUME 1 in picture 1.

- During function, place the heater in a safe position:
  - at least 1m far from inflammable objects or furnitures;
  - leaving not less than 1m of free space in front of the heater;
  - not located immediately below a socket-outlet.
- Do not leave animals or children touch or play with the appliance. Pay attention! The air outlet grille gets hot during operation (more than 90°C)
- **WARNING: In order to avoid overheating, do not cover the heater.** Do not hang anything on the heater and do not cover it while it's working. This is clearly written on the cover of the product or shown by the symbol



- Do not use the heater in rooms with explosive gas or while using inflammable solvents or varnish or glues.
- If the cordset is damaged and you have to change it, do not do the job yourselves! Take the product to an after sales authorised repair centre or to a person with similar skill and knowledge, in order to avoid any risk of danger.
- The appliance must be positioned so that the plug is always accessible.
- Do not mount the product on walls made of synthetic material.

## 2. WALL MOUNTING

- Only fix the heater in vertical position with the air outlet grid downward;
- This heater is fitted with a double electrical insulation circuit (class II) and therefore does not require an earth connection.
- This heater must be correctly installed in compliance with the regulations in force in the country of installation.
- In wet spaces like bathrooms or kitchens, the connection terminal must be installed at least 25 cm above the floor. The electrical connection to the power supply must also be fitted with a two-pole switch with a minimum gap between the contacts that allows complete disconnection according to excess voltage III category conditions.
- To choose the best installation position please consider that the sensor is able to detect movements in the areas shown in picture 2. Place the heater in the best position to detect people inside the room and to be clear from any object that may interfere with the sensor's beam. Detection is more efficient when people move in front of the product instead towards it.
- Always make observe the minimum distances from walls, furniture and/or objects, as indicated in picture 3. Never install the product so that the distance between the floor and the lower side of the product is less than 600 mm:
  - Drill three 6 mm diameter holes in the wall, as shown in picture 4
  - Insert the three wall plugs supplied with the product



- Insert the 2 upper screws, contained in the same bag, taking care to leave a distance of 8 mm between the head of the screws and the wall;
- Gripping the heater firmly, hook it onto the two screws; CAUTION! Before releasing the heater make sure it is attached to the 2 screws.
- Then secure the product with the lower screw.

### 3. FILTER

- This product is fitted with a filter to protect the heating element from dust and dirt.
- The filter is removable to be easily cleaned with water (picture 5).
- To keep the heater in perfect condition, clean the filter once every six months REMEMBERING TO PUT IT BACK AGAIN AFTERWARDS.
- Every 120 working hours, the user is notified of the need to clean the filter on the back of the product. The warning is given in the form of a running message on the display that reads:  
*" PULIRE FILTRO - CLEAN FILTER - NETTOYER FILTRE "*.
- Even when the display is showing the message indicated above, the product continues to work in the mode active at the time the notification appears.
- If any key is pushed the text is removed from the display. It will once again be displayed when the fan heater has been running for another hour.
- By holding the **(mode)** key down when the notification is displayed, the built-in counter is reset and the notification will be displayed again after another 120 working hours. Confirmation of resetting is given by a message on the display for 5 seconds that reads *" done "*.

### 4. TOWELS

- The product is equipped with a towel rail and n. 4 additional hooks placed on rail's back side.
- Please do not push or embed towel close to the air outlet grid (picture 6) but place them as shown in picture 7.

### 5. COMMAND DESCRIPTION AND FUNCTIONING

- The heater is fitted with a double pole electromechanical ON/OFF switch on its left side. Switching off the product the supply voltage is disconnected from all the internal components.
- The following controls are available on the front panel (picture 8):
  - A - Presence Sensor
  - B - Display
  - C - Show and increase
  - D - Show and decrease
  - E - Settings
  - F - Frost free mode
  - G - Programmed mode
  - H - Stand-by
  - I - Frost free mode led indicator
  - J - Programmed mode led indicator
  - K - Functioning led indicator

This bathroom fan heater features a presence sensor and an automatic power management function.

The presence sensor allows a reduced energy consumption, lowering automatically the ambient temperature when no one is detected in the room, while it comes back to the set comfort temperature, maintaining it throughout the time of someone's detection.

The automatic electronic power selection, instead, manages the consumption through an accurate and comfortable regulation in order to automatically keep constant the selected temperature, according to what has previously been set on the electronic thermostat.

The operation of the presence sensor cannot be disabled and the product can be used in two distinct modes: automatic or programmed.

#### Automatic Mode

The product is set to work at a comfort temperature whenever someone is detected in the room. Should no one be detected in the room for at least 10 minutes, the heater will automatically set the Eco mode (3,5°C less than the set Comfort temperature). Should no one be detected in the room for more than 36 hours, the heater will automatically set the Frost free mode (7°C). In case someone should be detected again for at least 2 minutes, the product will automatically increase the temperature to the comfort level.

In automatic mode is also available a special feature, which is activated at user's choice, which allows to detect the possible opening of a window and force the functioning to the Frost free mode to minimize energy waste.

### **Programmed Mode**

The product can be programmed, on hour base, for each day of the week. For each hour of the day it is possible to define the reference temperature to be reached/maintained, choosing between Comfort, Eco or Frost free.



In programmed mode the presence detector and the open window detection functions are disabled so that the product can correctly follow the temperature profile defined by the user.

## **6. LEDS COLOR**

- There are 3 different led lights on the product:
- Led light under the frost free button (picture 8, item I)
  - The led is red when the frost free mode is activated. It is switched off when the frost free mode is disabled.
  - Blinks when the Frost free mode was activated by the open window detection function.
- Led light under the Programmed mode button (picture 8, item J)
  - The led is red when the Programmed mode is activated. It is switched off when the Programmed mode is disabled.
- Led light under the stand-by button (picture 8, item K)
  - The led is red when the product is in the Comfort mode;
  - The led is green when the product is in the Eco mode;
  - The led is switched off when the product is in Stand-by.

## **7. USING THE FAN HEATER**

### **MAIN ON/OFF SWITCH**

The power supply of the product is controlled by an electromechanical ON/OFF switch. Switching off the fan heater will cut off the power to the electronic board and this will cause the loss of every stored information, after 30 minutes of absence of the power supply. We recommend to use this switch only when you are not using the product for long periods and instead to use the on / stand-by control for any short-term interruptions. In this way you will not lose the stored settings.

For the first use of the product or in case of power loss for over 30 minutes, when on ON position, the display shows 00:00 and begins counting the time starting from this value.



Should no adjustment be made within 15min after power up, the product will automatically switch in Frost free mode with the lighting of the corresponding led.

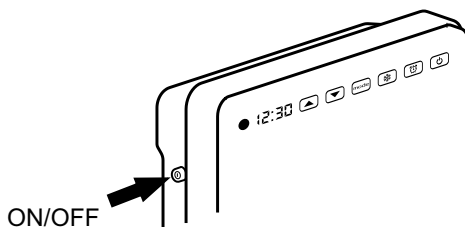

### **STAND-BY BUTTON**

Use this button  to switch ON or put the product in Stand-by mode. The led beneath the Stand-by button will light on in green color.

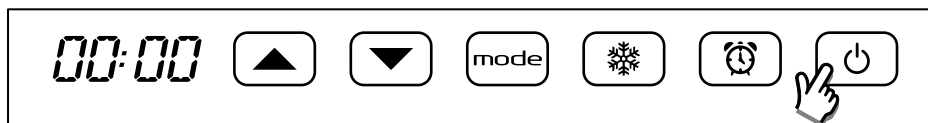

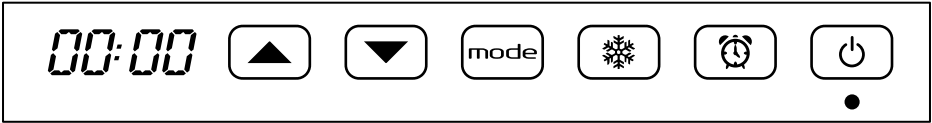

**SETTINGS**

The following keys (mode), (▲) and (▼), will allow you to adjust the current hour and day of the week (1 = Monday), the Comfort temperature and to activate or deactivate the open window detection function.  
 E.g.: To set 08:30, Tuesday, Comfort temperature of 25°C and enable the open window detection previously disabled, proceed as follows:

Press and hold the (mode) button for 3 seconds to enter the settings menu:

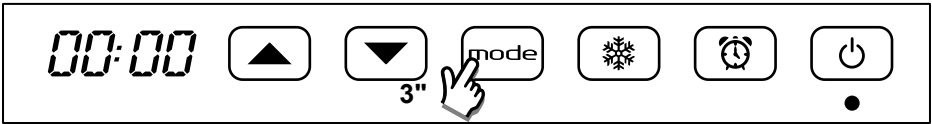

Set the time:

The 2 digits of the hour start blinking: set the current hour using (▲) and (▼) buttons

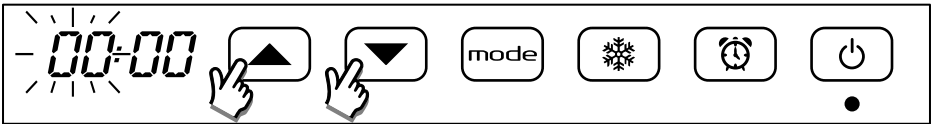

Press (mode) to confirm

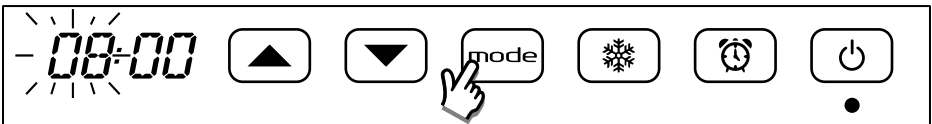

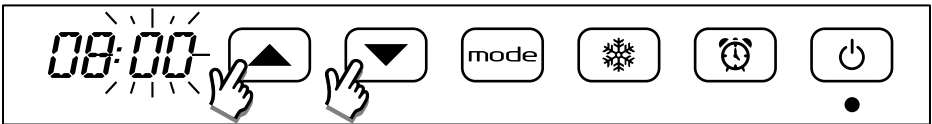

The 2 digits of the minutes start blinking: set the current minutes using (▲) and (▼) buttons

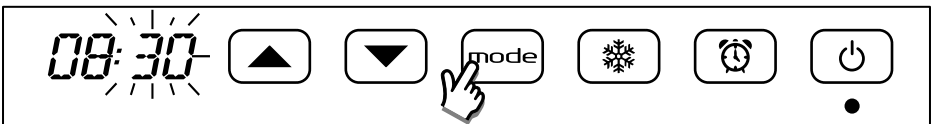

Press (mode) to confirm



Set the day of the week (1 = Monday)

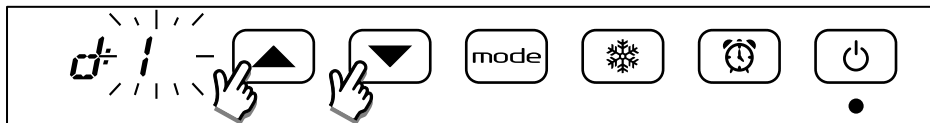

After confirming the time, the day of the week starts blinking: set the current day of the week using  and  buttons

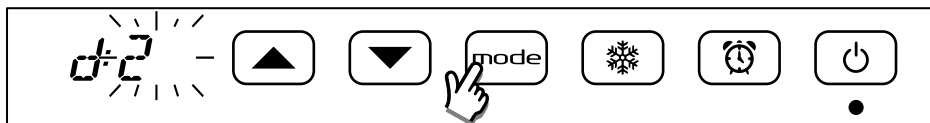

Press  to confirm



Set the Comfort temperature (Eco = Comfort - 3,5°C)

After confirming the day, the comfort temperature value starts blinking: set the desired temperature using  and  buttons

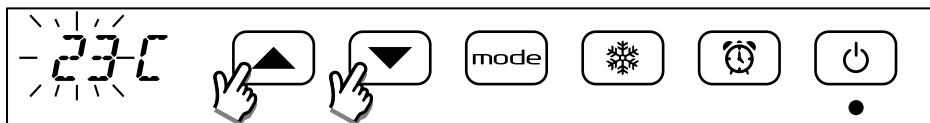

Press  to confirm

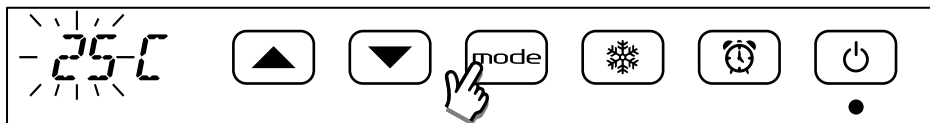

### OPEN WINDOW DETECTION

This function makes it possible to detect an open window and automatically activate the Anti-freeze operating mode. When the function is enabled and ready to set the Frost-free mode if an open windows is detected, a red dot lights up on the upper right area of the display between the 3<sup>rd</sup> and the 4<sup>th</sup> digit.





If a temperature drop is observed in the room during the normal functioning, the Frost-free mode is automatically activated to save energy consumption. The red light under the Frost-free button flashes to show that the open window function operates.

The reset of the normal functioning is not automatic but is achieved by pressing one of the five buttons of the product.



Correct operation of this function may depend on where the radiator is positioned in the room, the presence of draughts, the outside temperature, and how long the window stays open.

### Activate the open window detection function

After confirming the comfort temperature, window detection mode starts blinking. the display shows 88:on if the mode is activated and 88:0f if it is deactivated. Set the desired mode using  and  buttons.

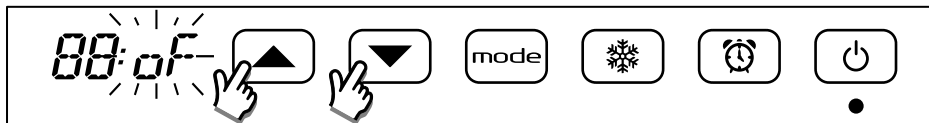

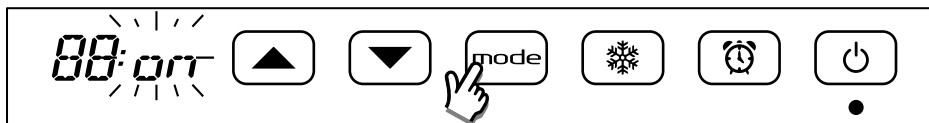

Press  to confirm



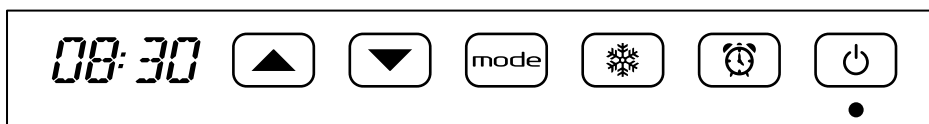

End of settings:



### DISPLAY / CHANGE THE COMFORT TEMPERATURE

You can check the set Comfort temperature at any time by pressing a single time the  or  key. A further press will modify the set temperature.

When in Eco mode, by pressing the  key the product will automatically turn back on Comfort temperature, without having to wait until the sensor detects the presence in the room for at least 2min.

Should you wish to view and / or change the temperature of comfort without leaving the ECO mode first press the  key. The Eco mode is always indicated by the green power light.

**Note:** The temperature measured by the inner sensor of the product is representative of the ambient temperature nearby it and it may differ from the temperature measured using other instruments in other areas of the room. That difference may depend on many factors including, for example:

- the installation position: some areas of the room may be affected by drafts or hot air sacs that modify the sensor measurement;
- the fixation to an external wall that, being normally colder than internal walls, may imply the measurement of a temperature lower than the real room temperature;
- a full load of towels on the support bar may obstruct the airflow. As a result the sensor may measure a temperature higher than the real room temperature;
- unstable conditions: any evaluation must be done in stable working conditions. For this purpose comfort temperature should be changed only 60min after a previous change. It is not possible, indeed, to evaluate the room temperature maintained by the product correctly if the comfort level temperature is continually changed in a short time.

If a difference between set temperature and room temperature is detected in stable working conditions, measure the difference and then increase or decrease the comfort temperature on the product of the exact value of measured difference.

### WEEKLY PROGRAM

The Programmed mode  allows to set, for every hour of day and for every day of the week independently, the desired temperature choosing between the Comfort, Eco (equal to that of Comfort decreased by 3.5 ° C) or Antifreeze.

A short press of the button  allows to activate/deactivate the programmed functioning. A long press (> 3") allows to enter the view/change menu. If the product is brand new the default program is the following:

Always Frost-free mode except Comfort mode in the following hours:

- from 06:00 to 08:00 on Monday-Friday;
- from 08:00 to 10:00 on Saturday-Sunday.





Press the dedicated button to quickly activate the program mode!

To view/change the program proceed as follows:

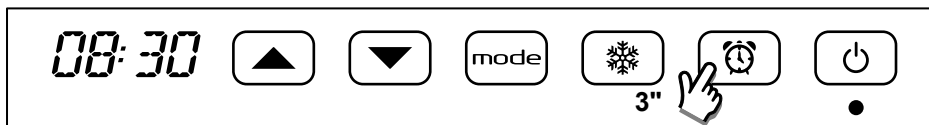
Press and hold the  button for 3 seconds to enter the menu:



The display shows the day 1 (Monday). By pressing the buttons  and  the different hours of the day are shown starting from "00" (hour between 00:00 e le 00:59):

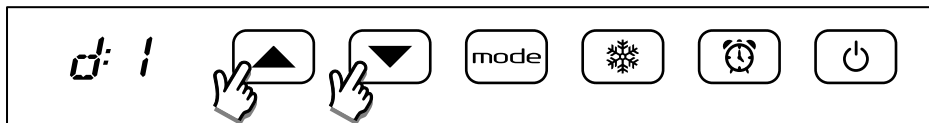

The reference temperature set for the selected hour is shown by the Frost-free led (temperature of 7°C), The green led under the Stand-by button (temperature Eco = Comfort - 3,5°C) or the red led under the Stand-by button (Comfort temperature set by the user):

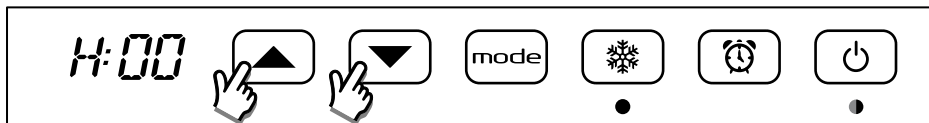

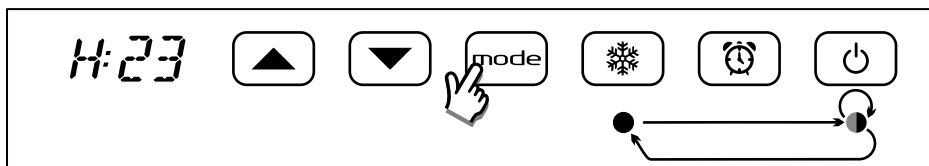

The reference temperature can be changed by pressing the  button. The led light corresponding to each different temperature (Comfort, Eco or Frost free) will light up in sequence to show the selected reference temperature:



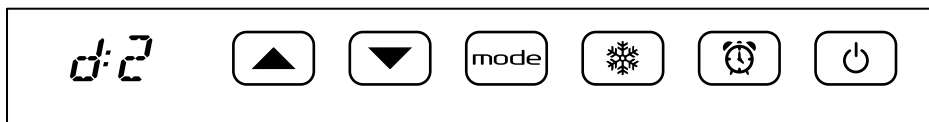
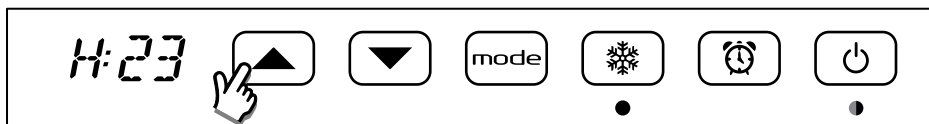

Use the buttons  and  to show/change the set temperature for each one of the hours of day 1. Once reached the last hour of the day (23) the next press of the button  allows to enter the programming for day 2:

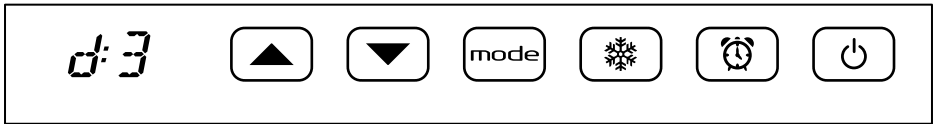
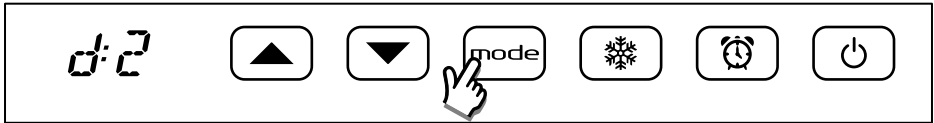

At this time it is possible to show/change the reference temperature for all the hours of the Day 2 or directly set the Day 2 identical to Day 1. In the first case just use the buttons  and  as already described for the day 1; in the second case just press the button  once. In this way the day 2 is automatically set equal to Day 1 and the system automatically goes at the beginning of Day 3. This procedure can be repeated until Day 7 programming:



At the end of Day 7 programming, or in any other intermediate step by pressing the button , the final confirm and save step is activated. The display shows "End" and the next press of the button  saves the program just shown/modified:

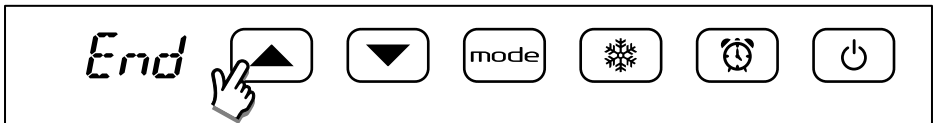

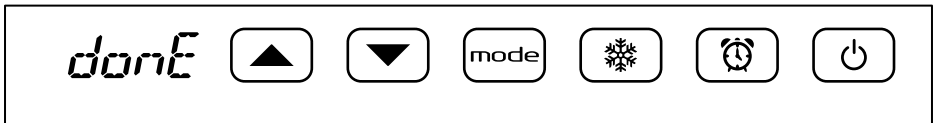

The display shows "donE" for some second to confirm that the program is correctly saved. The product goes in the mode programmed for the current time and day of the week.



**Note:**

-  -At any time you can abandon the procedure for viewing / editing the program deleting unsaved changes by pressing the Stand-by button;
- During the programming the heating elements are disconnected and the product doesn't heat.

**FROST FREE MODE**

To activate the Frost free Mode hold the  key for 3". The thermostat is now set to maintain  $7\pm 3^{\circ}\text{C}$ . To deactivate the Frost free position just press the  or the  button.

 Frost free mode will activate automatically when no one has been detected for at least 36 hours. In this case, the Comfort temperature will be automatically activated once a presence will have been detected.

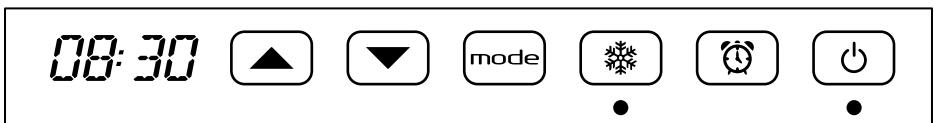
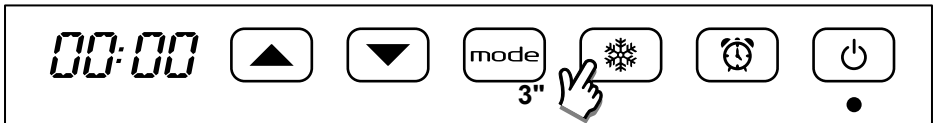

## 8. TROUBLESHOOTING

- In the event of overheating, the safety device on the appliance automatically disabled the heating elements and motor. In this case:
  - Turn off the fan heater and allow it to cool down for about 15/20 minutes.
  - Make sure the dust filter is not totally obstructed and clean if necessary. Remember to put it back again afterwards.
  - Eliminate any other possible reasons for overheating (e.g.: obstructions in front of the air inlet/outlet grilles, build-ups of dirt).
  - Turn on the fan heater again and check it works correctly.
- If the touch control commands are blocked or don't properly answer to digital pressure, turn off the heater using the electromechanic switch on the left side of the heater. Then turn on the heater using the same switch.

## 9. MAINTENANCE

- This product does not require any special maintenance.
- Clean the product with a dry cloth once every 6 months.
- If the product requires repairing, contact an authorised technical service centre.
- When replacing the power cable, use a 2x1,00mm<sup>2</sup> H05VV-F HAR type. This operation must be performed by qualified personnel and never by the end user in order to avoid damaging the appliance and jeopardising personal safety.

## 10. LEGAL NOTICE



### **Environment and recycling**

Please help us to protect the environment by disposing of the packaging in accordance with the national regulations for waste processing.

### **Recycling of obsolete appliances**

Appliances with this label must not be disposed off with the general waste. They must be collected separately and disposed off according to local regulations.



**Information requirements for electric local space heaters**

Model identifier(s): TOUCH					
Item	Symbol	Value	Unit	Item	Unit
<b>Heat output</b>				<b>Type of heat input, for electric storage local space heaters only (select one)</b>	
Nominal heat output	$P_{nom}$	1,8	kW	manual heat charge control, with integrated thermostat	no
Minimum heat output (indicative)	$P_{min}$	1,0	kW	manual heat charge control with room and/or outdoor temperature feedback	no
Maximum continuous heat output	$P_{max,c}$	1,8	kW	electronic heat charge control with room and/or outdoor temperature feedback	no
<b>Auxiliary electricity consumption</b>				fan assisted heat output	no
At nominal heat output	$eI_{max}$	1,800	kW	<b>Type of heat output/room temperature control (select one)</b>	
At minimum heat output	$eI_{min}$	1,000	kW	single stage heat output and no room temperature control	no
In standby mode	$eI_{SB}$	0,00076	kW	Two or more manual stages, no room temperature control	no
				with mechanic thermostat room temperature control	no
				with electronic room temperature control	no
				electronic room temperature control plus day timer	no
				electronic room temperature control plus week timer	yes
				<b>Other control options (multiple selections possible)</b>	
				room temperature control, with presence detection	yes
				room temperature control, with open window detection	yes
				with distance control option	no
				with adaptive start control	no
				with working time limitation	no
				with black bulb sensor	no
Contact details	See details on the rating plate of the product				

Lees deze instructies zorgvuldig door voordat u het verwarmingstoestel gebruikt. Zo voorkomt u schade en gevaarlijke situaties. Enig gebruik anders dan beschreven in deze handleiding kan brand, elektrische schokken of letsel veroorzaken en leidt ertoe dat de garantie vervalt.

De garantie geldt niet voor eventuele defecten, verslechtering, verlies, letsel of schade veroorzaakt door of als gevolg van het verkeerde gebruik of misbruik van dit toestel. Aan rechten die voortvloeien uit nationale wetgeving wordt geen afbreuk gedaan. Geen van de garantiebepalingen sluit voorwaarden of garanties uit die in nationale wetgeving vastgelegd zijn en niet uitgesloten of gewijzigd mogen worden.

Verwijder vóór het gebruik de verpakking en controleer of het apparaat intact is. Neem in geval van defecten of schade contact op met de dealer. Probeer het apparaat niet zelf te repareren.

Laat kinderen niet met de verpakking spelen en bescherm het milieu door de verpakking overeenkomstig de nationale voorschriften voor afvalverwerking te verwijderen.

## 1. VOOR UW VEILIGHEID

- Dit apparaat is bedoeld voor normaal huishoudelijk gebruik en niet voor gebruik in voertuigen of aan boord van schepen of vliegtuigen.
- Dit apparaat kan worden gebruikt door kinderen vanaf 8 jaar en personen met verminderde lichamelijke, zintuiglijke of verstandelijke vermogens of een gebrek aan ervaring en kennis, mits ze onder toezicht staan of instructies hebben gekregen over hoe ze het apparaat op een veilige manier kunnen gebruiken en de risico's begrijpen. Kinderen mogen niet met het apparaat spelen. Reiniging of onderhoud mag niet door kinderen worden uitgevoerd, tenzij onder toezicht.
- Kinderen jonger dan 3 jaar moeten uit de buurt van het apparaat worden gehouden, tenzij er voortdurend toezicht is.
- Kinderen vanaf 3 jaar en jonger dan 8 jaar mogen het apparaat alleen in-/uitschakelen indien het op de beoogde, normale plek van gebruik is geplaatst of geïnstalleerd, en ze onder toezicht staan of instructies hebben gekregen over hoe ze het apparaat op een veilige manier kunnen gebruiken en de risico's begrijpen. Kinderen vanaf 3 jaar en jonger dan 8 jaar mogen het apparaat niet aansluiten, instellen of schoonmaken, of onderhoud uitvoeren.
- **LET OP — Sommige delen van dit apparaat kunnen zeer heet worden en brandwonden veroorzaken. Let vooral op wanneer kinderen en kwetsbare personen aanwezig zijn.**
- Controleer of de netvoeding overeenkomt met de gegevens op het typeplaatje. 230 V~, 50 Hz.

- Dit verwarmingstoestel is waterbestendig (IP24) en kan daarom in badkamers of andere vochtige ruimtes worden gebruikt, **MITS HET NIET IN DE ZONE VAN BADKUIPEN OF DOUCHES WORDT GEÏNSTALLEERD**. Dit betekent dat het toestel niet in de zone aangeduid als VOLUME 1 (afbeelding 1) mag worden geïnstalleerd.
- Als u het apparaat inschakelt, moet het op een veilige plek zijn gemonteerd:
  - op minstens 1 m van ontvlambare objecten of meubilair;
  - 1 m vóór het apparaat mogen zich geen objecten bevinden;
  - niet direct onder een stopcontact.
- Laat dieren of kinderen niet met het apparaat spelen; ze mogen het bovendien niet aanraken.
- Let op! Het luchtuitlaatrooster kan erg warm worden als het apparaat in werking is ( $> 90\text{ }^{\circ}\text{C}$ ).
- **WAARSCHUWING: Om oververhitting te voorkomen, mag het apparaat niet worden bedekt.** Hang geen voorwerpen over het verwarmingstoestel en bedek het niet terwijl het in werking is. Dit is duidelijk op het apparaat vermeld of wordt aangegeven door het symbool:



- Gebruik het apparaat niet in ruimtes met explosieve gassen of terwijl u ontvlambare oplosmiddelen, lak of lijm gebruikt.
- Indien het netsnoer beschadigd is en vervangen moet worden, mag u dit niet zelf doen! Breng het apparaat naar een bevoegd reparatiecentrum of een persoon met vergelijkbare kennis en vaardigheden. Zo voorkomt u gevaarlijke situaties.
- Het apparaat moet zodanig worden gemonteerd dat het stopcontact altijd bereikbaar is.
- Bevestig het apparaat niet op wanden van synthetisch materiaal.

## 2. WANDMONTAGE

- Het verwarmingstoestel uitsluitend verticaal (met het luchtuitlaatrooster naar onderen gericht) monteren.
- Dit toestel beschikt over een dubbel elektrisch isolatiecircuit (klasse II). Een aardverbinding is daarom niet nodig.
- Dit toestel moet correct en conform de in uw land geldende voorschriften worden geïnstalleerd.
- In vochtige ruimtes (bijv. badkamer of keuken) moet het aansluitblok ten minste 25 cm boven de vloer worden geïnstalleerd. Voor de elektrische aansluiting op de netvoeding moet ook een 2-polige schakelaar met een

minimale contactopening worden gebruikt, zodat volledige ontkoppeling overeenkomstig de voorwaarden van overspanningscategorie III mogelijk is.

- Bij het kiezen van de beste installatiepositie moet u er rekening mee houden dat de sensor bewegingen detecteert in de zones die in afbeelding 2 te zien zijn. Positioneer het apparaat zodanig dat het zonder problemen mensen in de ruimte kan detecteren en de straal van de sensor niet wordt belemmerd. Detectie is bovendien effectiever wanneer personen voor de sensor langs lopen in plaats van ernaartoe.
- Neem altijd de minimumafstanden tot wanden, meubels en/of objecten in acht (zie afbeelding 3). De afstand tussen de vloer en de onderkant van het apparaat mag niet minder dan 600 mm bedragen:
  - Boor drie gaten met een diameter van 6 mm in de wand (zie afbeelding 4);
  - Steek de drie bij het apparaat meegeleverde wandpluggen in de wand;
  - Steek de twee bovenste schroeven (in hetzelfde zakje) in de pluggen en zorg ervoor dat de afstand tussen de kop van de schroeven en de wand 8 mm bedraagt;
  - Pak het verwarmingstoestel goed vast en haak het op de twee schroeven. LET OP! Voordat u het toestel loslaat, moet u controleren of het op de twee schroeven gehaakt is;
  - Maak het toestel vervolgens vast met de onderste schroef.

## 3. FILTER

- Dit apparaat heeft een filter dat het verwarmingselement tegen stof en vuil beschermt.
- Het filter kan verwijderd worden (afbeelding 5). Hierna kunt u het eenvoudig met water reinigen.
- Om ervoor te zorgen dat het apparaat in perfecte staat blijft, moet het filter elke zes maanden worden schoongemaakt. VERGEET NIET HET FILTER NADERHAND TERUG TE PLAATSEN.
- Elke 120 bedrijfsuren, wordt de gebruiker geïnformeerd over de noodzaak om het filter te reinigen aan de achterzijde van het product. De waarschuwing wordt gegeven in de vorm van een lopend bericht op het scherm dat luidt:

“PULVERE FILTER - CLEAN FILTER - REPLACE FILTER”

- Zelfs als de display de boodschap hierboven aangeeft, blijft het product werken in de actief modus op het moment dat deze melding verschijnt.
- Als een willekeurige toets wordt ingedrukt wordt de tekst verwijderd uit het display. Deze zal opnieuw worden weergegeven wanneer de fan heater opnieuw een uur in bedrijf is.
- Door de mode-toets  ingedrukt vast te houden wanneer deze melding wordt weergegeven, wordt de ingebouwde teller gereset en de melding opnieuw weergegeven na nog eens 120 bedrijfsuren. De bevestiging van de reset wordt gegeven door het bericht op het display gedurende 5 seconden “done”.

## 4. HANDDOEKEN

- Het apparaat is voorzien van een handdoekhouder en biedt 4 extra haken op de achterkant van de houder.
- Plaats handdoeken niet zoals in afbeelding 6 (uitlaatrooster wordt geblokkeerd), maar hang ze op zoals in afbeelding 7.

## 5. BESCHRIJVING BEDIENING EN GEBRUIK

- Het apparaat beschikt aan de linkerkant over een 2-polige elektromechanische AAN-UITSCHAKELAAR. Als u het toestel uitzet, worden alle interne componenten spanningsvrij geschakeld.
- De volgende bedieningselementen zijn beschikbaar op het voorpaneel (afbeelding 8):
  - A - Aanwezigheidssensor
  - B - Display
  - C - Toets tonen en verhogen
  - D - Toets tonen en verlagen
  - E - Mode instellingen
  - F - Toets vorstvrije modus
  - G - Weekprogramma modus
  - H - Toets standby
  - I - Ledindicatorlampje vorstvrije modus
  - J - Ledindicatorlampje weekprogramma modus
  - K - Ledindicatorlampje functie

Deze fan heater voor de badkamer beschikt over een aanwezigheidssensor en automatische energiebeheerfunctie. De aanwezigheidssensor zorgt voor een lager energieverbruik door automatisch de omgevingstemperatuur te verlagen wanneer er geen personen in de ruimte gedetecteerd worden. Indien de sensor wel een persoon detecteert, wordt de temperatuur tot de ingestelde comforttemperatuur verhoogd.

De automatische elektronische vermogensselectie beheert daarentegen het verbruik door middel van een nauwkeurige en comfortabele instelling om zo de geselecteerde temperatuur te handhaven (op basis van de gekozen instelling op de elektronische thermostaat).

De aanwezigheidssensor kan niet worden uitgeschakeld en heeft twee verschillende modi: automatisch of geprogrammeerd.

### **Automatische modus**

Het apparaat handhaaft de handmatig ingestelde comforttemperatuur wanneer een persoon in de ruimte gedetecteerd wordt. Indien de sensor ten minste 10 minuten lang niemand in de ruimte detecteert, schakelt de verwarming automatisch over naar de ECO temperatuur/modus (ECO temperatuur/modus = 3,5°C lager dan de ingestelde COMFORT temperatuur/modus). Wanneer langer dan 36 uur niemand in de ruimte gedetecteerd wordt, schakelt de verwarming automatisch in de vorstrijke modus (7 °C). Als een persoon weer ten minste 2 minuten gedetecteerd wordt, verhoogt het apparaat vervolgens automatisch de temperatuur naar COMFORT niveau.

In de automatische modus is tevens een speciale functie beschikbaar, die door de gebruiker geactiveerd kan worden. Deze functie detecteert of een raam openstaat en schakelt het apparaat automatisch naar de vorstvrije modus om energieverstopping te beperken.



### **Weekprogramma modus**

Het apparaat kan op uurbasis worden geprogrammeerd, voor elke dag van de week. Voor elk uur van de dag kan de keuzetemperatuur worden ingesteld die moet worden bereikt/gehandhaafd. U heeft daarbij keuze uit de temperaturen, COMFORT, ECO of VORSTVRIJ.



In de weekprogramma modus zijn de aanwezigheidssensor en de openraamdetectie uitgeschakeld, zodat het apparaat het door de gebruiker ingestelde temperatuurprofiel correct kan volgen.

## **6. KLEUR LEDS**

- Het apparaat is voorzien van 3 verschillende leds:
- Led onder de VORSTVRIJ toets  (afbeelding 8, item I)
  - De led is rood wanneer de VORSTVRIJ modus geactiveerd is,
  - De led brandt niet wanneer de VORSTVRIJ modus uitgeschakeld is.
  - De led knippert als de VORSTVRIJ modus geactiveerd is door de OPEN-RAAM-DETECTIE.
- Led onder de knop WEEKPROGRAMMA  (afbeelding 8, item J)
  - De led is rood wanneer de WEEKPROGRAMMA modus geactiveerd is,
  - De led brandt niet wanneer de WEEKPROGRAMMA modus uitgeschakeld is.
- Led onder de STANDBY toets  (afbeelding 8, item K)
  - De led is rood wanneer de COMFORT modus geactiveerd is;
  - De led is groen wanneer de ECO modus geactiveerd is;
  - De led brandt niet wanneer het apparaat op STANDBY staat.

## **7. DE FAN HEATER GEBRUIKEN**

AAN-/UITSCHAKELAAR (witte ronde knop op de linkerzijkant)

De voeding van het apparaat wordt geregeld door een elektromechanische AAN-/UITSCHAKELAAR. Als u de fan heater uitschakelt, wordt de stroomtoevoer naar de printplaat onderbroken. Na 30 minuten van onderbreking gaat alle opgeslagen informatie verloren. Wij raden aan deze schakelaar alleen te gebruiken wanneer u het apparaat lange tijd niet gebruikt. Gebruik in plaats daarvan de aan/STANDBY toets  voor korte onderbrekingen; zo verliest u de opgeslagen instellingen niet.

Als het apparaat voor het eerst wordt gebruikt of de voeding langer dan 30 minuten onderbroken is, toont het display (indien AAN) 00:00 en begint de tijd vanaf deze waarde te tellen.



Indien binnen 15 minuten na inschakeling geen aanpassing wordt gedaan, schakelt het apparaat automatisch naar de vorstvrije modus  (de bijbehorende led gaat branden).

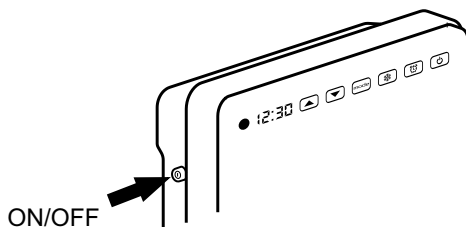

## STANDBY toets

Gebruik de STANDBY toets  om het apparaat AAN te zetten of de Standby-modus in te schakelen.

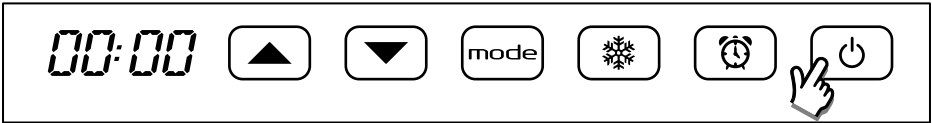

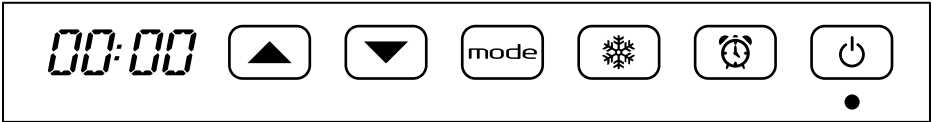

De led onder de STANDBY toets  wordt groen.



LED=GROEN

## START: BASIS INSTELLINGEN

Met de ,  en -toetsen moet u **ALTIJD EERST DE HUIDIGE TIJD EN DAG VAN DE WEEK INSTELLEN:** (d:1 = maandag, d:2 = dinsdag, d:3 = woensdag, etc.), alsmede de COMFORT temperatuur (gewenste ruimte-temperatuur) aanpassen en de OPEN-RAAM-DETECTIE functie aanzetten (88:ON) of uitzetten (88:OF).

**VOORBEELD BASIS INSTELLING:** Stel het is nu dinsdag 08.30 's morgens en u wilt de basisinstellingen programmeren met de vaste COMFORT temperatuur van 25 °C en met de OPEN-RAAM-DETECTIE aan, dan moet u het volgende doen:

Houd de -toets 3 seconden ingedrukt om het instellingenmenu te openen:

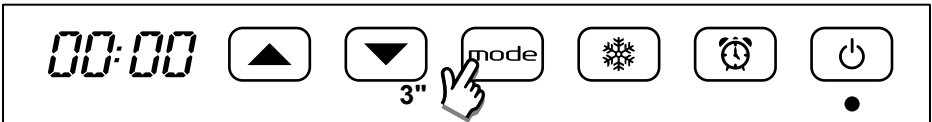

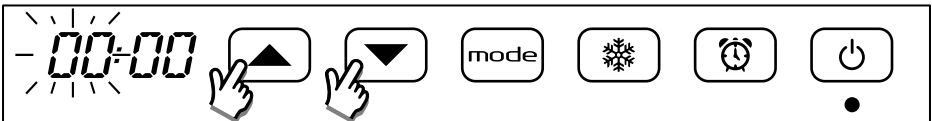

**STEL DE HUIDIGE TIJD IN** (volgens dit voorbeeld 08.30, in werkelijkheid de huidige tijd instellen!):

De 2 urrecijfers beginnen te knipperen: stel het huidige uur in met de  en -toetsen.

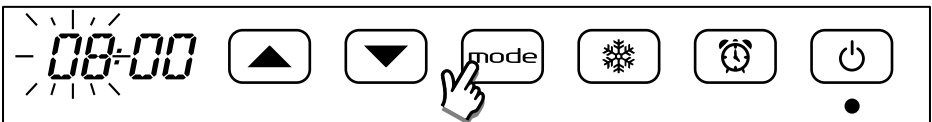

Druk op  om te bevestigen (volgens dit voorbeeld **08.30**, in werkelijkheid de huidige tijd, instellen!):



De 2 minutencijfers beginnen te knipperen: stel de huidige minuten in met de  en -toetsen.

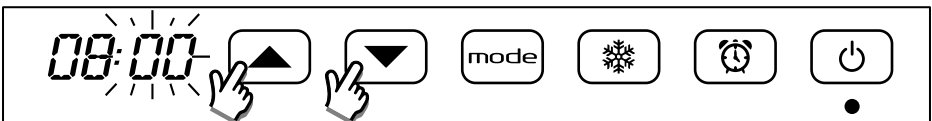

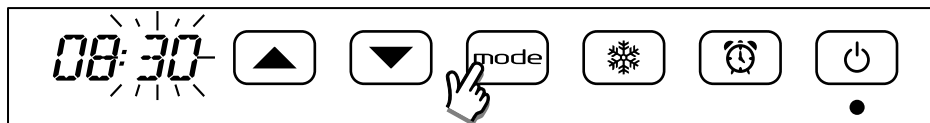

Druk op  om te bevestigen (volgens dit voorbeeld **08.30**, in werkelijkheid de huidige tijd, instellen!):



**STEL DE HUIDIGE DAG VAN DE WEEK IN** (d:1 = maandag, d:2 = dinsdag, d:3 = woensdag etc.)

Volgens het voorbeeld is het nu dinsdag, d:2.

Nadat u de tijd heeft bevestigd, gaat de dag van de week knippen: **STEL DE HUIDIGE DAG VAN DE WEEK IN** met de  en -toetsen.

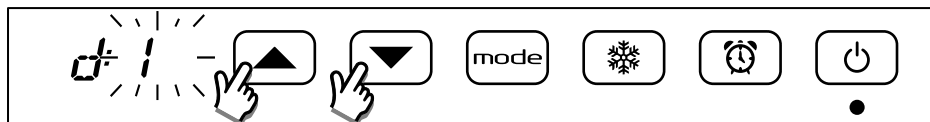

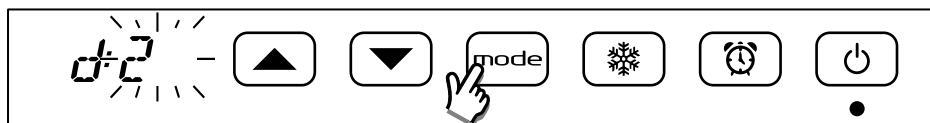

Druk op  om te bevestigen (volgens dit voorbeeld dinsdag **d:2**, in werkelijkheid de huidige dag, instellen!):



**STEL NU DE GEWENSTE COMFORT TEMPERAATUUR IN** (=gewenste ruimtetemperatuur, **IN DIT VOORBEELD 25 °C**)  
Hierdoor wordt nu ook automatisch de ECO temperatuur bepaald.

(ECO temperatuur = COMFORT temperatuur - 3,5 °C)

Nadat u de dag heeft bevestigd, gaat de COMFORT temperatuurwaarde knippen: stel de gewenste temperatuur in met de  en -toetsen.

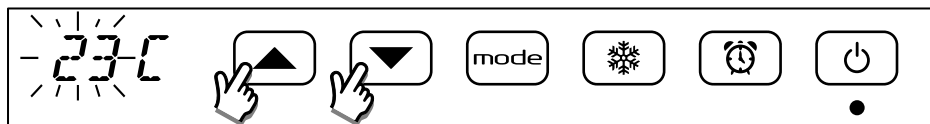

Druk op  om te bevestigen (volgens dit voorbeeld **25.°C**, in werkelijkheid de huidige temperatuur instellen!):

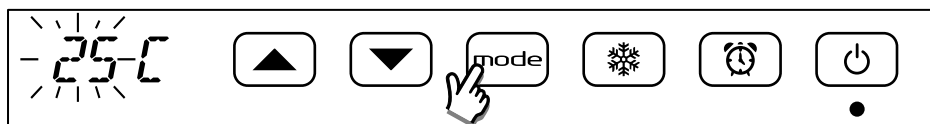

**OPEN-RAAM-DETECTIE** (functie aanzetten **88:0n**) of uitzetten (**88:0F**)

Deze functie maakt het mogelijk een open raam te detecteren en automatisch de vorstvrije modus te activeren. Indien de functie ingeschakeld en gereed is om de vorstvrije modus te activeren als er een open raam gedetecteerd wordt, licht er rechtsboven op het display een rode punt tussen het 3e en 4e cijfer op:



Indien de temperatuur in de ruimte daalt tijdens de normale werking, wordt automatisch de VORSTVRIJ modus geactiveerd om energie te besparen. De rode led onder de VORSTVRIJ-toets knippert om aan te geven dat de OPEN-RAAM-DETECTIE actief is.

De normale werking wordt niet automatisch gereset; druk hiervoor op een van de vijf toetsen van het apparaat.



De correcte werking van deze functie is afhankelijk van de plaats waar het toestel in de ruimte geïnstalleerd is, de aanwezigheid van tocht, de buitentemperatuur en hoe lang het raam open blijft.

### OPEN-RAAM-DETECTIE ACTIVEREN

Nadat u de COMFORT temperatuur heeft bevestigd, begint de OPEN-RAAM-DETECTIE modus te knipperen. Het display toont **88:oN** als de modus aan staat en **88:oF** als deze gedeactiveerd is. Stel de gewenste modus in met de en -toetsen.

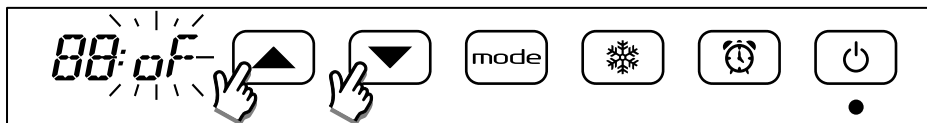

Druk op om te bevestigen.

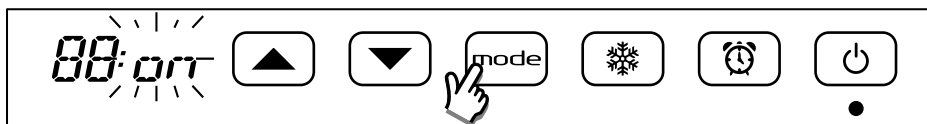

### EINDE: BASIS INSTELLINGEN

U heeft nu de juiste TIJD, DAG, COMFORT temperatuur en OPEN-RAAM-DETECTIE vast ingesteld.

(al deze basisinstellingen gelden nu voor **ALLE DAGEN VAN DE WEEK d:1 T/M d:7** en voor de gehele verdere werking van de fanheater)

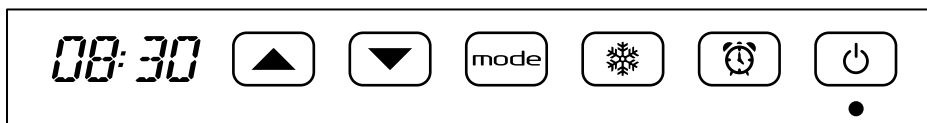

### COMFORTTEMPERATUUR TONEN/WIJZIGEN

U kunt de ingestelde comforttemperatuur op elk moment bekijken door één keer op de of -toets te drukken.

Als u nogmaals drukt, kunt u de ingestelde temperatuur naar boven met de -toets of met de naar beneden -toets aanpassen.

Wanneer de ECO modus actief is en u op de -toets drukt, schakelt het apparaat automatisch de COMFORT temperatuur weer in. U hoeft niet te wachten tot de sensor ten minste 2 minuten lang iemand in de ruimte detecteert. Indien u de COMFORT temperatuur wilt bekijken/aanpassen zonder de ECO modus te verlaten, drukt u eerst op de -toets. Indien de ECO modus actief is, brandt de led groen.

**OPMERKING:** De temperatuur die door de binnensensor van het apparaat wordt gemeten, is de omgevingstemperatuur vlakbij het apparaat en kan afwijken van de temperatuur die met andere instrumenten in andere delen van de ruimte wordt gemeten. Het verschil kan van een groot aantal factoren afhankelijk zijn, bijvoorbeeld:

- plaats van installatie: in sommige delen van de ruimte is er sprake van tocht of warme luchtzakken die de meting van de sensor beïnvloeden;
- montage op een externe muur: deze is gewoonlijk kouder dan een interne muur, wat ertoe kan leiden dat een temperatuur gemeten wordt die lager is dan de echte temperatuur in de ruimte.
- veel handdoeken op de handdoekhouder: dit kan de luchtstroom belemmeren. Als gevolg hiervan kan de sensor een temperatuur meten die hoger is dan de echte temperatuur in de ruimte.
- onstabiele omstandigheden: een beoordeling moet plaatsvinden bij stabiele omstandigheden. Hiertoe mag de comforttemperatuur uitsluitend 60 minuten na een eerdere aanpassing worden gewijzigd. Indien de comforttemperatuur in korte tijd vaak wordt aangepast, kan de temperatuur die het apparaat in een ruimte handhaaft niet correct worden beoordeeld.

Als bij stabiele omstandigheden een verschil tussen de ingestelde temperatuur en kamertemperatuur wordt gedetecteerd, moet u het verschil meten en de comforttemperatuur verhogen of verlagen op basis van het exact gemeten verschil.



## WEEKPROGRAMMA OPTIES:

**Optie 1. STANDAARD WEEKPROGRAMMA (FABRIEKINSTELLING)**

of

**Optie 2. BEKIJKEN EN-OF WIJZIGEN VAN HET STANDAARD WEEKPROGRAMMA**



Indien het apparaat nieuw is, is het STANDAARD WEEKPROGRAMMA als volgt:

### Optie 1. WEEKPROGRAMMA STANDAARD

VORSTVRIJ modus is altijd actief, met uitzondering van de COMFORT-modus op de volgende tijden:

- van 06:00 tot 08:00 op maandag-vrijdag;

- van 08:00 tot 10:00 op zaterdag-zondag.

 Druk 1 seconde op de **WEEKPROGRAMMA** -toets om het STANDAARD WEEKPROGRAMMA (FABRIEKINSTELLING) modus te activeren/deactiveren!

### Optie 2. BEKIJKEN EN-OF WIJZIGEN VAN HET STANDAARD WEEKPROGRAMMA

Met behulp van de WEEKPROGRAMMA modus  kunt u voor:

ELK UUR VAN DE DAG en voor

ELKE DAG VAN DE WEEK

AZONDERLIJK DE GEWENSTE TEMPERATUUR instellen, waarbij u keuze heeft uit:

COMFORT (reeds door uzelf ingesteld bij BASIS INSTELLING)



ECO (De ECO temperatuur wordt automatisch bepaald door de COMFORT temperatuur-minus 3,5 °C)

VORSTVRIJ (vaste fabriekinstelling instelling 7 °C)

Als u het STANDAARD WEEKPROGRAMMA wilt BEKIJKEN EN-OF WIJZIGEN, moet u het volgende doen:

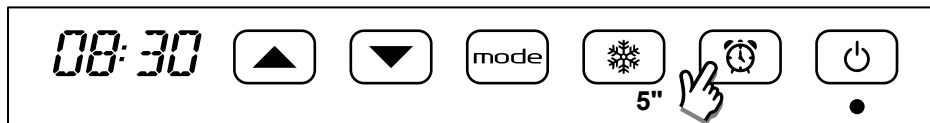
Houd de -toets **5 seconden** ingedrukt om het menu te openen:



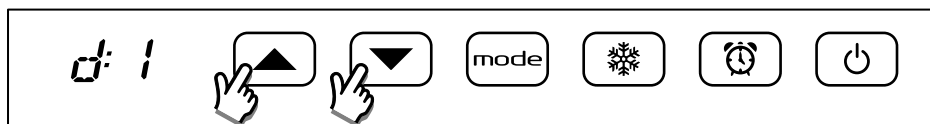

Het display toont dag 1 (d:1 maandag). Als u nu op de  - en -toetsen drukt, worden de VERSCHILLENDE UREN van de dag getoond, beginnende bij H:00 (dit is de tijd vanaf 00:00 tot 01:00 uur) en eindigend bij H:23 (dit is de tijd vanaf 23:00 tot 00:00 uur



De reeds eerder ingestelde referentietemperatuur VORSTVRIJ, ECO of COMFORT kunt u nu voor alle VERSCHILLENDE UREN H:00 t/m H:23 individueel instellen, dit blijkt uit de LEDS die OPLICHTEN ONDER DE:

VORSTVRIJ toets  RODE LED =VORSTVRIJ temperatuur (vast ingestelde temperatuur 7 °C)

STANDBY toets  RODE LED=COMFORT temperatuur (reeds door uzelf ingesteld bij BASIS INSTELLING)

STANDBY toets  GROENE LED=ECO temperatuur

(De ECO temperatuur wordt automatisch bepaald door de COMFORT temperatuur-minus 3,5 °C)

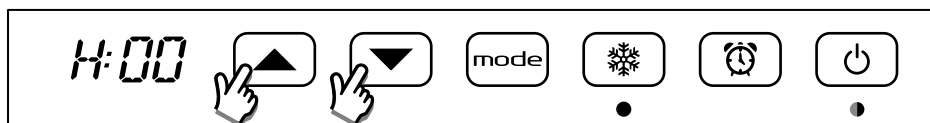

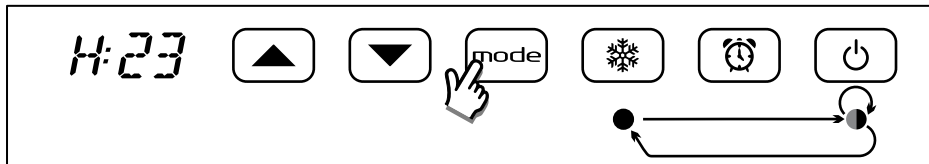

ROOD=VORSTVRIJ GROEN=ECO / ROOD=COMFORT

De referentietemperatuur kan worden aangepast door op de -toets te drukken. De led die overeenkomt met elke verschillende gewenste temperatuur VORSTVRIJ, ECO of COMFORT en licht in volgorde op, en toont hiermee de geselecteerde referentietemperatuur: VORSTVRIJ, ECO of COMFORT.



ROOD=VORSTVRIJ GROEN=ECO / ROOD=COMFORT

Gebruik de  en -toetsen om de ingestelde temperatuur voor elk van de uren van dag 1 te bekijken en/of te wijzigen. Als het laatste uur van de dag (H:23) is bereikt, drukt u nogmaals op de -toets om het programma voor dag 2 te openen:

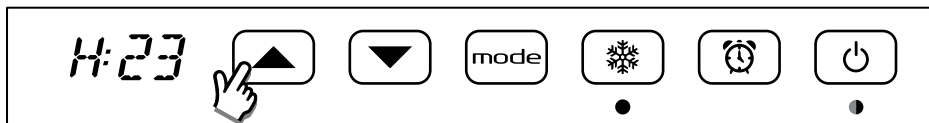

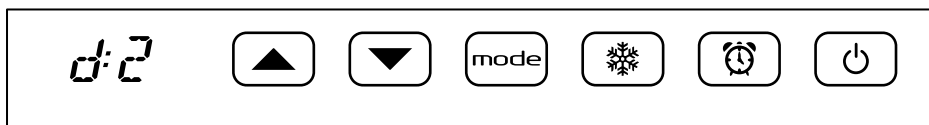

ROOD=VORSTVRIJ GROEN=ECO / ROOD=COMFORT





**Alle dagen identiek:**

Indien u direct dag 2 identiek als dag 1 in wil stellen dan drukt u één keer op de -toets. Zo wordt dag 2 automatisch hetzelfde ingesteld als dag 1 en gaat het systeem automatisch naar het begin van dag 3. Deze procedure kan tot en met dag 7 worden herhaald:

**Alle of meerdere dagen afwijkend:**

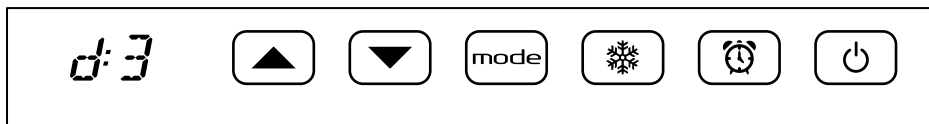
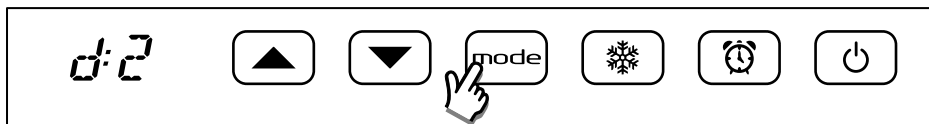
Het is ook mogelijk om de referentietemperaturen voor alle uren van dag 2 te bekijken en/of te wijzigen. In dit geval gebruikt u de  en -toetsen, zoals reeds beschreven voor dag 1.



Nadat dag 7 is geprogrammeerd (of in elke tussenliggende stap), kunt u de laatste stap (BEVESTIGEN EN OPSLAAN) activeren door op de -toets te drukken. Het display toont "End". Door nogmaals op de -toets te drukken, wordt het net bekeken/gewijzigde programma opgeslagen:

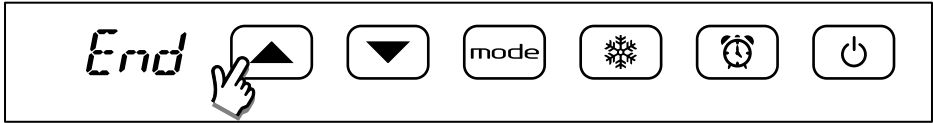

Op het display verschijnt enkele seconden lang "Done" ter bevestiging dat het programma juist is opgeslagen. Het apparaat schakelt over naar de WEEKPROGRAMMA modus voor de huidige tijd en dag van de week.

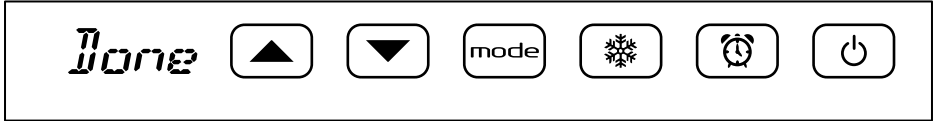

**Opmerking:**



- U kunt de procedure voor het bekijken/wijzigen van het programma op elk moment beëindigen door op de  standby-toets te drukken; niet-opgeslagen wijzigingen worden dan gewist.
- De verwarmingselementen zijn uitgeschakeld tijdens het programmeren en het apparaat verwarmt niet.

**VORSTVRIJ MODUS**

Als u de VORSTVRIJ modus wilt activeren, dient u de  -toets 3 seconden ingedrukt te houden. De thermostaat handhaaft de temperatuur op 7 °C.

Om de VORSTVRIJ modus te deactiveren, drukt u op de  of  -toets.



De VORSTVRIJ modus wordt automatisch geactiveerd indien er gedurende 36 uur geen persoon is gedetecteerd. De COMFORT temperatuur wordt in dit geval automatisch geactiveerd wanneer een persoon wordt gedetecteerd.

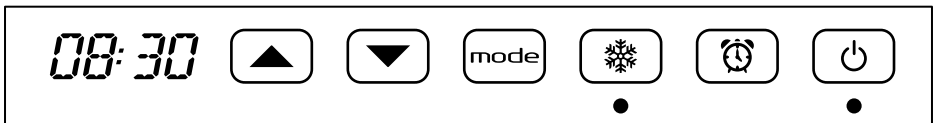
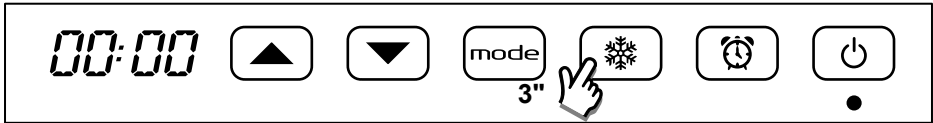

**8. PROBLEEMOPLOSSING**

- In geval van oververhitting schakelt de veiligheidsvoorziening van het apparaat de verwarmingselementen en motor automatisch uit. In dat geval moet u het volgende doen:
  - Schakel de fan heater uit en laat deze gedurende circa 15/20 minuten afkoelen.
  - Controleer of het stoffilter niet te vervuild of geblokkeerd is en maak het indien nodig schoon. Plaats het filter naderhand terug.
  - Controleer of er andere oorzaken van oververhitting zijn (bijv. objecten die zich voor het luchtinlaat-/uitlaatrooster bevinden, vuilophoping).
  - Zet de fan heater weer aan en controleer of deze correct functioneert.
- Indien de toetsen geblokkeerd zijn of niet juist reageren als erop gedrukt wordt, moet u het apparaat uitschakelen met de elektromechanische schakelaar aan de linkerkant. Schakel de verwarming vervolgens weer in met dezelfde schakelaar.

**9. ONDERHOUD**

- Dit apparaat vereist geen specifiek onderhoud.
- Maak het apparaat om de zes maanden met een droge doek schoon.
- Indien het apparaat gerepareerd dient te worden, dient u contact op te nemen met een erkend technisch servicecentrum.

- Als het netsnoer vervangen moet worden, dient een 2 x 1,00 mm<sup>2</sup>-kabel (type H05VV-F HAR) te worden gebruikt. Dit mag uitsluitend door gekwalificeerd personeel en nooit door de eindgebruiker zelf worden gedaan om schade aan het apparaat en persoonlijk letsel te voorkomen.

## 10. JURIDISCHE MEDEDELING



### Milieu en recycling

Help ons mee het milieu te beschermen. Verwijder de verpakking daarom overeenkomstig de nationale voorschriften voor afvalverwerking.

### Recycling van oude toestellen

Toestellen met dit symbool horen niet thuis in de vuilnisbak. Ze moeten apart worden ingezameld en volgens lokale voorschriften worden verwijderd.

### Informatie-eisen voor elektrische toestellen voor lokale ruimteverwarming

Typeaanduiding(en): TOUCH					
Item	Symbool	Waarde	Eenheid	Item	Eenheid
<b>Warmteafgifte</b>				<b>Type warmte-input, uitsluitend voor elektrische warmteopslagtoestellen (selecteer één)</b>	
Nominale warmteafgifte	$P_{nom}$	1,8	kW	Handmatige sturing van de warmteopslag, met geïntegreerde thermostaat	neen
Minimale warmteafgifte (indicatief)	$P_{min}$	1,0	kW	Handmatige sturing van de warmteopslag, met kamer- en/of buitentemperatuurfeedback	neen
Maximale continue warmteafgifte	$P_{max,c}$	1,8	kW	Elektronische sturing van de warmteopslag, met kamer- en/of buitentemperatuurfeedback	neen
<b>Aanvullend elektriciteitsverbruik</b>				Door een ventilator bijgestane warmteafgifte	neen
Bij nominale warmteafgifte	$eI_{max}$	1,800	kW	<b>Type warmteafgifte/sturing kamertemperatuur (selecteer één)</b>	
Bij minimale warmteafgifte	$eI_{min}$	1,000	kW	Eentrapswarmteafgifte, geen sturing van de kamertemperatuur	neen
In stand-bymodus	$eI_{sb}$	0,00076	kW	Twee of meer handmatig in te stellen trappen, geen sturing van de kamertemperatuur	neen
				Met mechanische sturing van de kamertemperatuur door thermostaat	neen
				Met elektronische sturing van de kamertemperatuur	neen
				Elektronische sturing van de kamertemperatuur plus dag-tijdschakelaar	neen
				Elektronische sturing van de kamertemperatuur plus week-tijdschakelaar	ja
				<b>Andere sturingsopties (meerdere selecties mogelijk)</b>	
				Sturing van de kamertemperatuur, met aanwezigheidsdetectie	ja
				Sturing van de kamertemperatuur, met openraamdetectie	ja
				Met de optie van afstandsbediening	neen
				Met adaptieve sturing van de start	neen
				Met beperking van de werkingstijd	neen
				Met black-bulbsensor	neen
Contactgegevens	Zie details op het typeplaatje van het product				