

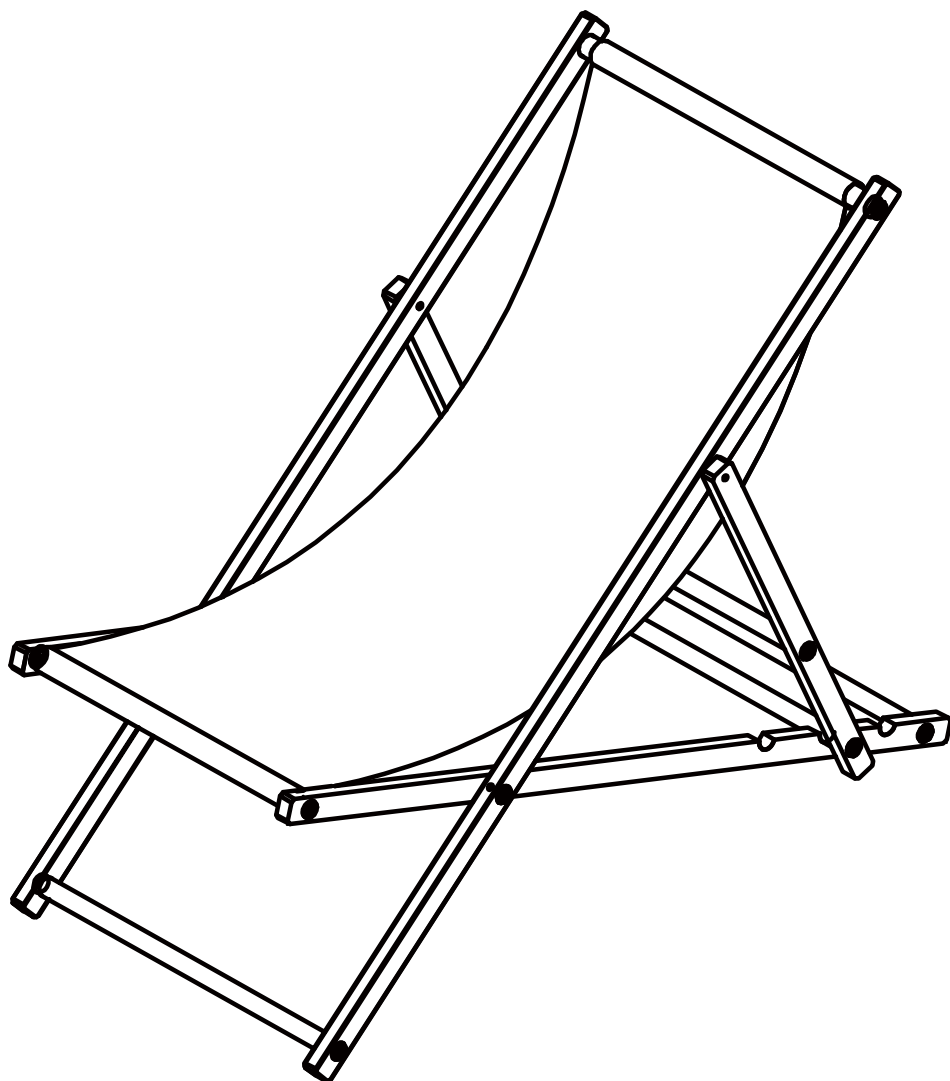









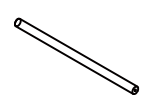
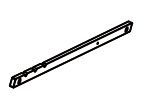

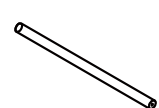
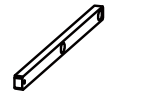
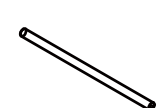
# CHILIENNE

1417\_103777/103778/103779/103780/103781/103782



1417_103777/103778/103779/103780/103781/103782					
<b>A</b>	 1170 X2	1/1	<b>B</b>	 500 X2	1/1
<b>C</b>	 985 X1	1/1	<b>D</b>	 985 X1	1/1
<b>E</b>	 460 X2	1/1	<b>F</b>	 500 X2	1/1
<b>G</b>	 540 X2	1/1	<b>H</b>	 X1	1/1
<b>I</b>	 X1	1/1	<b>J</b>	 X1	1/1
<b>K</b>	 M6.2*50 X12	1/1	<b>L</b>	 X20	1/1
<b>M</b>	 M6 X4	1/1	<b>N</b>	 M6*50 X4	1/1

FR : SAV/INFORMATION /VIDEO/CONTACT

EN: AFTER-SALES SERVICE/INFORMATION/VIDEO/CONTACT

DE : REPARATUR-SERVICE UND ERSATZTEILE /INFORMATIONEN /VIDEO/KONTAKT

ES: SERVICIO POST-VENTA/INFORMACI N/VIDEO/CONTACTO

IT: SERVIZIO ASSISTENZA/INFORMAZIONI/VIDEO/CONTATTO

PT: SERVIÇO P S-VENDA/INFORMAÇÕES/VIDEO/CONTATO

PL: SERWIS TECHNICZNY/INFORMACJE/WIDEO/KONTAKT

NE: AFTER SALES SERVICE/INFORMATIE/VIDEO/CONTACT

HE: סע רשקתל/ואדיווה/ עדימ/תוריקמו תוריש רחאל

**SAV.HABITATETJARDIN.COM**

