

evOLUTION®

www.evolutionpowertools.com

RAGE5-S

Original Instructions



(1.2)

This Instruction Manual was originally written in UK English

(1.3) **IMPORTANT**

Please read these operating and safety instructions carefully and completely.

For your own safety, if you are uncertain about any aspect of using this equipment please access the relevant technical helpline, the number of which can be found on the Evolution Power Tools website. We operate several helplines throughout our worldwide organization, but technical help is also available from your supplier.

WEB: www.evolutionpowertools.com

(1.4)

Congratulations on your purchase of an Evolution Power Tools machine. Please complete your product registration 'online' as explained in the A4 online guarantee registration leaflet included with this machine. We sincerely thank you for selecting a product from Evolution Power Tools.

MACHINE SPECIFICATIONS

MACHINE	METRIC	IMPERIAL
Motor UK/EU: 220-240V ~ 50Hz	S1 1500W S6 40% 1800W	-
Motor UK: 110V ~ 50Hz	1600W	-
Motor US/CAN: 120V ~ 60Hz	-	15A
Minimum Table Surface Area:	745mm x 640mm	29-1/4 x 25-3/16"
Maximum Table Surface Area:	1200mm x 640mm	47-1/4 x 25-3/16"
Dimensions With Leg Assembly (H x W x L):	1050 x 750 x 940mm	41-1/8 x 29-1/2 x 37"
Dimensions Without Leg Assembly (H x W x L):	880 x 730 x 330mm	34-5/8 x 28-3/4 x 13"
Speed (No Load)	2500min ⁻¹	2500rpm
Net Weight	29.5kg	65 lb
Gross Weight	35kg	77.2 lb
CUTTING CAPACITIES		
Mild Steel Plate – Max Thickness	6mm	1/4"
Mild Steel Box Section – Optimal Wall Thickness	3mm	1/8"
Wood - Maximum Depth Of Cut At 90°	83mm	3-1/4"
Wood - Maximum Depth Of Cut At 45°	58 mm	2-1/4"
Rip Capacity - Left Of The Blade	305mm	12"
Rip Capacity - Right Of The Blade	650mm	25-1/2"
Riving Knife Thickness	1.8mm	0 - 5/64"
BLADE		
Diameter	255mm	10"
Bore	25.4mm	1"
Kerf	2mm	.078"
Teeth (UK/EU)	28	
Teeth (USA)	24	
NOISE & VIBRATION DATA		
Sound Pressure L _A	93.2dB(A)	
Sound Power Level L _{WA}	106.2dB(A)	
Uncertainty K	3dB(A)	

WARNING: The noise emissions during actual use of the power tool can differ from the declared values depending on the ways in which the tool is used especially what kind of workpiece is processed.

WARNING: The need to identify safety measures to protect the operator that are based on an estimation of exposure in the actual conditions of use (taking account of all parts of the operating cycle such as the times when the tool is switched off and when it is running idle in addition to the trigger time).

(1.7) VIBRATION

WARNING: When using this machine the operator can be exposed to high levels of vibration transmitted to the hand and arm. It is possible that the operator could develop "Vibration white finger disease" (Raynaud syndrome). This condition can reduce the sensitivity of the hand to temperature as well as producing general numbness. Prolonged or regular users of this machine should monitor the condition of their hands and fingers closely. If any of the symptoms become evident, seek immediate medical advice.

- The measurement and assessment of human exposure to hand-transmitted vibration in the workplace is given in: BS EN ISO 5349-1:2001 and BS EN ISO 5349-2:2002
- Many factors can influence the actual vibration level during operation e.g. the work surfaces condition and orientation and the type and condition of the machine being used. Before each use, such factors should be assessed, and where possible appropriate working practices adopted. Managing these factors can help reduce the effects of vibration:

Handling

- Handle the machine with care, allowing the machine to do the work.
- Avoid using excessive physical effort on any of the machines controls.
- Consider your security and stability, and the orientation of the machine during use.

Work Surface

- Consider the work surface material; its condition, density, strength, rigidity and orientation.

WARNING: The vibration emission during actual use of the power tool can differ from the declared total value depending on the ways in which the tool is used. The need to identify safety measures and to protect the operator are based on an estimation of exposure in the actual conditions of use (taking account of all parts of the operating cycle, such as the times the tool is switched off, when it is running idle, in addition to trigger time).

Warning: Wear hearing protection!

(1.8) LABELS & SYMBOLS

WARNING: Do not operate this machine if warning and/or instruction labels are missing or damaged. Contact Evolution Power Tools for replacement labels.

Note: All or some of the symbols on the next page may appear in the manual or on the product.

(1.9)

Symbol	Description
V	Volts
A	Amperes
Hz	Hertz
min ⁻¹	Speed
~	Alternating Current
n _o	No Load Speed
	Wear Safety Goggles
	Wear Ear Protection
	Do Not Touch
	Wear Dust Protection
	Wear Safety Gloves
	Read Instructions
	CE Certification
	EAC Certification
	Triman - Waste Collection & Recycling
	Waste Electrical & Electronic Equipment
	Warning
	Protection Class II Double Insulated
	(RCM) Regulatory Compliance Mark for electrical and electronic equipment. Australian/New Zealand Standard
	ETL Certification

(1.10) INTENDED USE OF THIS POWER TOOL

WARNING: This product is a table saw and has been designed to be used with special Evolution blades. Only use accessories designed for use in this machine and/or those recommended specifically by **Evolution Power Tools Ltd.**

When fitted with an appropriate blade this machine can be used to cut:

Mild Steel (Max Thickness 6mm / 1/4")
 Aluminium (Max Thickness 6mm / 1/4")
 Wood and wood based materials (Max Thickness 80mm)

Note: Cutting galvanised steel may reduce blade life.

(1.11)

PROHIBITED USE OF THIS POWER TOOL

WARNING: This product is a table saw and must only be used as such. It must not be modified in any way, or used to power any other equipment or drive any other accessories other than those mentioned in this instruction manual.

(1.13) WARNING: This machine is not intended for use by persons (including children) with reduced physical, sensory or mental capabilities, or lack of experience and knowledge, unless they have been given supervision or instruction concerning the safe use of the machine by a person responsible for their safety and who is competent in its safe use.

Children should be supervised to ensure that they do not have access to, and are not allowed to play with, this machine.

SAFETY PRECAUTIONS

(1.14) ELECTRICAL SAFETY

This machine is fitted with the correct moulded plug and mains lead for the designated market. If the mains lead or the plug are damaged in any way, they must be replaced with original replacement parts by a competent technician.

(1.15) OUTDOOR USE

WARNING: For your protection if this tool is to be used outdoors it should not be exposed to rain, or used in damp locations. Do not place the tool on damp surfaces. Use a clean, dry workbench if available. For added protection use a residual current device (R.C.D.) that will interrupt the supply if the leakage current to earth exceeds 30mA for 30ms. Always check the operation of the residual current device (R.C.D.) before using the machine.

If an extension cable is required it must be a suitable type for use outdoors and so labelled.

The manufacturers instructions should be followed when using an extension cable.

(2.1) POWER TOOL GENERAL SAFETY INSTRUCTIONS

WARNING: Read all safety warnings and instructions. Failure to follow the warnings and instructions may result in electric shock, fire and/or serious injury.

Note: This power tool should not be powered on continuously for a long time.

Save all warnings and instructions for future reference.

The term "power tool" in the warnings refers to your mains-operated (corded) power tool or battery-operated (cordless) power tool.

(2.2) 1) General Power Tool Safety Warnings [Work area safety]

- a)** Keep work area clean and well lit. Cluttered or dark areas invite accidents.
- b)** Do not operate power tools in explosive atmospheres, such as in the presence

of flammable liquids, gasses or dust. Power tools create sparks which may ignite the dust or fumes.

- c)** Keep children and bystanders away while operating power tool. Distractions can cause you to lose control.
- d)** Do not use this machine in an enclosed room.

(2.3) 2) General Power Tool Safety Warnings [Electrical Safety]

a) Power tool plugs must match the outlet. Never modify the plug in any way. Do not use any adapter plugs with earthed (grounded) power tools. Unmodified plugs and matching outlets will reduce the risk of electric shock.

b) Avoid body contact with earthed or grounded surfaces, such as pipes, radiators, ranges and refrigerators. There is an increased risk of electric shock if your body is earthed or grounded.

c) Do not expose power tools to rain or wet conditions. Water entering a power tool will increase the risk of electric shock.

d) Do not abuse the cord. Never use the cord for carrying, pulling or unplugging the power tool. Keep cord away from heat, oil, sharp edges or moving parts. Damaged or entangled cords increase the risk of electric shock.

e) When operating a power tool outdoors, use an extension cord suitable for outdoor use. Use of a cord suitable for outdoor use reduces the risk of electric shock.

f) If operating a power tool in a damp location is unavoidable, use a residual current device (RCD) protected supply. Use of an RCD reduces the risk of electric shock.

(2.4) 3) General Power Tool Safety Warnings [Personal Safety].

a) Stay alert, watch what you are doing and use common sense when operating a power tool. Do not use a power tool while you are tired or under the influence of drugs, alcohol or medication. A moment of inattention while operating power tools may result in serious personal injury.

b) Use personal protective equipment. Always wear eye protection to prevent injury from sparks and chippings. Protective equipment such as dust masks, non-skid safety shoes,

hard hat or hearing protection used for appropriate conditions will reduce personal injuries.

c) Prevent unintentional starting. Ensure the switch is in the off-position before connecting to power source and or battery pack, picking up or carrying the tool. Carrying power tools with your finger on the switch or energising the power tools that have the switch on invites accidents.

d) Remove any adjusting key or wrench before turning the power tool on. A wrench or key left attached to a rotating part of a power tool may result in personal injury .

e) Do not overreach. Keep proper footing and balance at all times. This enables better control of the power tool in unexpected situations.

f) Dress properly. Do not wear loose clothing or jewellery. Keep your hair, clothing and gloves away from moving parts. Loose clothes, jewellery or long hair can be caught in moving parts.

g) If devices are provided for the connection of dust extraction and collection facilities, ensure that these are connected and properly used. Use of dust collection can reduce dust-related hazards.

h) When cutting metal, gloves should be worn before handling to prevent from getting burnt from hot metal.

i) Do not let familiarity gained from frequent use of tools allow you to become complacent and ignore tool safety principles. A careless action can cause severe injury within a fraction of a second.

(2.5) 4) General Power Tool Safety Warnings [Power tool use and care].

a) Do not force the power tool. Use the correct power tool for your application. The correct power tool will do the job better and safer at a rate for which it was designed.

b) Do not use the power tool if the switch does not turn it on or off. Any power tool that cannot be controlled with the switch is dangerous and must be repaired.

c) Disconnect the power tool from the power source and/or battery pack from the power tool before making any adjustments, changing accessories, or storing power tools. Such preventative safety measures reduce the

risk of starting the power tool accidentally.

d) Store idle power tools out of the reach of children and do not allow persons unfamiliar with the power tool or these Instructions to operate the power tool. Power tools are dangerous in the hands of untrained users.

e) Maintain power tools. Check for misalignment or binding of moving parts, breakage of moving parts and any other condition that may affect the power tools operation. If damaged, have the power tool repaired before use. Many accidents are caused by poorly maintained power tools.

f) Keep cutting tools sharp and clean. Properly maintained cutting tools with sharp cutting edges are less likely to bind and are easier to control.

g) Use the power tool, accessories and tool bits etc. in accordance with these instructions, taking into account the working conditions and the work to be performed. Use of the power tool for operations different from those intended could result in a hazardous situation.

h) Keep handles and grasping surfaces dry, clean and free from oil and grease. Slippery handles and grasping surfaces do not allow for safe handling and control of the tool in unexpected situations.

(2.6)

5) General Power Tool Safety Warnings [Service]

a) Have your power tool serviced by a qualified repair person using only identical replacement parts. This will ensure that the safety of the power tool is maintained.

(2.7) HEALTH ADVICE

WARNING: When using this machine, dust particles may be produced. In some instances, depending on the materials you are working with, this dust can be particularly harmful. If you suspect that paint on the surface of material you wish to cut contains lead, seek professional advice. Lead based paints should only be removed by a professional and you should not attempt to remove it yourself. Once the dust has been deposited on surfaces, hand to mouth contact can result in the ingestion of lead. Exposure to even low levels of lead can

cause irreversible brain and nervous system damage. The young and unborn children are particularly vulnerable. You are advised to consider the risks associated with the materials you are working with and to reduce the risk of exposure. As some materials can produce dust that may be hazardous to your health, we recommend the use of an approved face mask with replaceable filters when using this machine.

You should always:

- Work in a well-ventilated area.
- Work with approved safety equipment, such as dust masks that are specially designed to filter microscopic particles.

(2.8)

WARNING: the operation of any power tool can result in foreign objects being thrown towards your eyes, which could result in severe eye damage. Before beginning power tool operation, always wear safety goggles or safety glasses with side shield or a full face shield where necessary.

ADDITIONAL SAFETY INSTRUCTIONS - TABLE SAWS

1) Guarding related warnings

- a) Keep guards in place.** Guards must be in working order and be properly mounted. A guard that is loose, damaged, or is not functioning correctly must be repaired or replaced.
- b) Always use saw blade guard, riving knife and anti-kickback device for every through-cutting operation.** For through-cutting operations where the saw blade cuts completely through the thickness of the workpiece, the guard and other safety devices help reduce the risk of injury.
- c) Immediately reattach the guarding system after completing an operation (such as rabbeting, dadoing or resawing cuts) which requires removal of the guard, riving knife and/or anti-kickback device.** The guard, riving knife, and anti-kickback device help to reduce the risk of injury.

d) Make sure the saw blade is not contacting the guard, riving knife or the workpiece before the switch is turned on. Inadvertent contact of these items with the saw blade could cause a hazardous condition.

e) Adjust the riving knife as described in this instruction manual. Incorrect spacing, positioning and alignment can make the riving knife ineffective in reducing the likelihood of kickback.

f) For the riving knife and anti-kickback device to work, they must be engaged in the workpiece. The riving knife and anti-kickback device are ineffective when cutting workpieces that are too short to be engaged with the riving knife and anti-kickback device. Under these conditions a kickback cannot be prevented by the riving knife and anti-kickback device.

g) Use the appropriate saw blade for the riving knife. For the riving knife to function properly, the saw blade diameter must match the appropriate riving knife and the body of the saw blade must be thinner than the thickness of the riving knife and the cutting width of the saw blade must be wider than the thickness of the riving knife.

2) Cutting procedures warnings

- a)  DANGER: Never place your fingers or hands in the vicinity or in line with the saw blade.** A moment of inattention or a slip could direct your hand towards the saw blade and result in serious personal injury.
- b) Feed the workpiece into the saw blade only against the direction of rotation.** Feeding the workpiece in the same direction that the saw blade is rotating above the table may result in the workpiece, and your hand, being pulled into the saw blade.
- c) Never use the mitre gauge to feed the workpiece when ripping and do not use the rip fence as a length stop when cross cutting with the mitre gauge.** Guiding the workpiece with the rip fence and the mitre gauge at the same time increases the likelihood of saw blade

binding and kickback.

- d) When ripping, always apply the workpiece feeding force between the fence and the saw blade. Use a push stick when the distance between the fence and the saw blade is less than 150mm, and use a push block when this distance is less than 50mm.** “Work helping” devices will keep your hand at a safe distance from the saw blade.
- e) Use only the push stick provided by the manufacturer or constructed in accordance with the instructions.** This push stick provides sufficient distance of the hand from the saw blade.
- f) Never use a damaged or cut push stick.** A damaged push stick may break causing your hand to slip into the saw blade.
- g) Do not perform any operation “freehand”. Always use either the rip fence or the mitre gauge to position and guide the workpiece.** “Freehand” means using your hands to support or guide the workpiece, in lieu of a rip fence or mitre gauge. Freehand sawing leads to misalignment, binding and kickback.
- h) Never reach around or over a rotating saw blade.** Reaching for a workpiece may lead to accidental contact with the moving saw blade.
- i) Provide auxiliary workpiece support to the rear and/or sides of the saw table for long and/or wide workpieces to keep them level.** A long and/or wide workpiece has a tendency to pivot on the table’s edge, causing loss of control, saw blade binding and kickback.
- j) Feed workpiece at an even pace. Do not bend or twist the workpiece. If jamming occurs, turn the tool off immediately, unplug the tool then clear the jam.** Jamming the saw blade by the workpiece can cause kickback or stall the motor.
- k) Do not remove pieces of cut-off material while the saw is running.** The material may become trapped between the fence or inside the saw blade guard and the saw blade pulling your fingers into the saw blade. Turn the saw off and wait until the saw blade stops before removing material.
- l) Use an auxiliary fence in contact with**

the table top when ripping workpieces less than 2mm thick. A thin workpiece may wedge under the rip fence and create a kickback.

3) Kickback causes and related warnings

Kickback is a sudden reaction of the workpiece due to a pinched, jammed saw blade or misaligned line of cut in the workpiece with respect to the saw blade or when a part of the workpiece binds between the saw blade and the rip fence or other fixed object.

Most frequently during kickback, the workpiece is lifted from the table by the rear portion of the saw blade and is propelled towards the operator.

Kickback is the result of saw misuse and/or incorrect operating procedures or conditions and can be avoided by taking proper precautions as given below.

- a) Never stand directly in line with the saw blade. Always position your body on the same side of the saw blade as the fence.** Kickback may propel the workpiece at high velocity towards anyone standing in front and in line with the saw blade.
- b) Never reach over or in back of the saw blade to pull or to support the workpiece.** Accidental contact with the saw blade may occur or kickback may drag your fingers into the saw blade.
- c) Never hold and press the workpiece that is being cut off against the rotating saw blade.** Pressing the workpiece being cut off against the saw blade will create a binding condition and kickback.
- d) Align the fence to be parallel with the saw blade.** A misaligned fence will pinch the workpiece against the saw blade and create kickback.
- e) Use a featherboard to guide the workpiece against the table and fence when making non-through cuts such as rabbeting, dadoing or resawing cuts.** A featherboard helps to control the workpiece in the event of a kickback.
- f) Use extra caution when making a**

cut into blind areas of assembled workpieces. The protruding saw blade may cut objects that can cause kickback.

- g) Support large panels to minimise the risk of saw blade pinching and kickback.** Large panels tend to sag under their own weight. Support(s) must be placed under all portions of the panel overhanging the table top.
- h) Use extra caution when cutting a workpiece that is twisted, knotted, warped or does not have a straight edge to guide it with a mitre gauge or along the fence.** A warped, knotted, or twisted workpiece is unstable and causes misalignment of the kerf with the saw blade, binding and kickback.
- i) Never cut more than one workpiece, stacked vertically or horizontally.** The saw blade could pick up one or more pieces and cause kickback.
- j) When restarting the saw with the saw blade in the workpiece, centre the saw blade in the kerf so that the saw teeth are not engaged in the material.** If the saw blade binds, it may lift up the workpiece and cause kickback when the saw is restarted.
- k) Keep saw blades clean, sharp, and with sufficient set. Never use warped saw blades or saw blades with cracked or broken teeth.** Sharp and properly set saw blades minimise binding, stalling and kickback.

4) Table saw operating procedure warnings

- a) Turn off the table saw and disconnect the power cord when removing the table insert, changing the saw blade or making adjustments to the riving knife, anti-kickback device or saw blade guard, and when the machine is left unattended.** Precautionary measures will avoid accidents.
- b) Never leave the table saw running unattended. Turn it off and don't leave the tool until it comes to a complete stop.** An unattended running saw is an uncontrolled hazard.
- c) Locate the table saw in a well-lit and**

level area where you can maintain good footing and balance. It should be installed in an area that provides enough room to easily handle the size of your workpiece. Cramped, dark areas, and uneven slippery floors invite accidents.

- d) Frequently clean and remove sawdust from under the saw table and/or the dust collection device.** Accumulated sawdust is combustible and may self-ignite.
- e) The table saw must be secured.** A table saw that is not properly secured may move or tip over.
- f) Remove tools, wood scraps, etc. from the table before the table saw is turned on.** Distraction or a potential jam can be dangerous.
- g) Always use saw blades with correct size and shape (diamond versus round) of arbour holes.** Saw blades that do not match the mounting hardware of the saw will run off-centre, causing loss of control.
- h) Never use damaged or incorrect saw blade mounting means such as flanges, saw blade washers, bolts or nuts.** These mounting means were specially designed for your saw, for safe operation and optimum performance.
- i) Never stand on the table saw, do not use it as a stepping stool.** Serious injury could occur if the tool is tipped or if the cutting tool is accidentally contacted.
- j) Make sure that the saw blade is installed to rotate in the proper direction. Do not use grinding wheels, wire brushes, or abrasive wheels on a table saw.** Improper saw blade installation or use of accessories not recommended may cause serious injury.

ATTENTION

The equipment is intended for use only in premises having a service current capacity 100A per phase, supplied from a distribution network having a nominal voltage of 230V, and instruct the user to determine in consultation with the supply authority, if necessary, that the service current capacity at the interface point is sufficient for the equipment. The equipment shall be clearly

marked as being suitable for use only in premises having a service current capacity equal to or greater than 100 A per phase.

(4.1)

GETTING STARTED UNPACKING

Caution: This packaging contains sharp objects. Take care when unpacking. Remove the machine, together with the accessories supplied from the packaging. Check carefully to ensure that the machine is in good condition and account for all the accessories listed in this manual. Also make sure that all the accessories are complete. If any parts are found to be missing, the machine and its accessories should be returned together in their original packaging to the retailer. Do not throw the packaging away; keep it safe throughout the guarantee period. Dispose of the packaging in an environmentally responsible manner. Recycle if possible. Do not let children play with empty plastic bags due to the risk of suffocation.

SERIAL NO. / BATCH CODE

The manufacturing date code is the first part of the serial number, found on the motor housing of the machine. Evolution serial numbers begin with the abbreviation of the machine followed by a letter. A = January, B = February and so on. The following 2 numbers are the year of manufacture. 09 = 2009, 10 = 2010, etc. (Example of batch code: XXX-A10)



For instructions on how to identify the batch code, please contact the Evolution Power Tools helpline or go to:
www.evolutionpowertools.com

(4.2) ITEMS SUPPLIED

Description	Quantity
Instruction Manual	1
Multi-material Blade	1
Blade Guard with Extraction Port	1
Dust Extraction Hose	1
Mitre Gauge	1
Anti-Bounce Device	1
Adjustable Rip Fence	1
Push Stick	1
Blade Changing Spanners	2
Assorted fixings	1 Bag

(4.3) ADDITIONAL ACCESSORIES

In addition to the standard items supplied with this machine the following accessories are also available from the Evolution online shop at www.evolutionpowertools.com or from your local retailer

(4.4)

Description	Part No UK/EU
Multi-material Blade UK/EU	RAGEBLADE-255MULTI
Multi-material Blade US	RAGE255BLADE
Wood Blade UK/EU	RAGEBLADE-255WOOD
Wood Blade US	10BLADEWD

MACHINE OVERVIEW

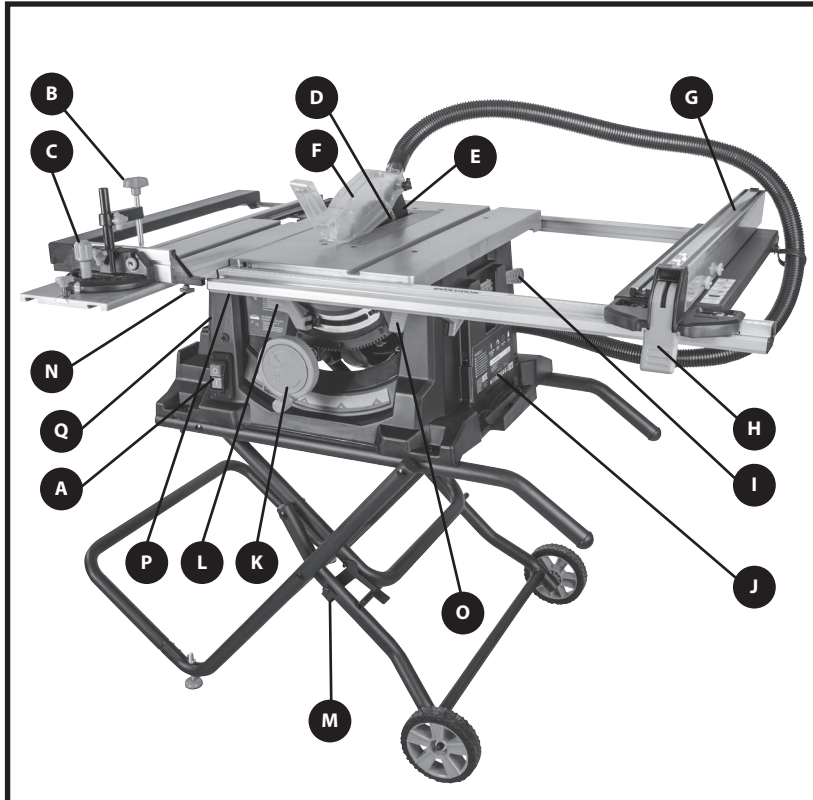

- | | |
|---|---|
| A. ON/OFF SWITCH | J. SERIAL NUMBER / RATING LABEL |
| B. HOLD DOWN CLAMP | K. RISE AND FALL / BEVEL ADJUSTMENT HAND WHEEL |
| C. SLIDING MITRE FENCE / MATERIAL PUSHER | L. BEVEL LOCKING LEVER |
| D. BLADE (NOT VISIBLE) | M. LATCHING PIN |
| E. RIVING KNIFE (NOT VISIBLE) | N. SLIDING CARRIAGE UNLOCKING PIN |
| F. BLADE GUARD | O. RIGHT HAND SIDE TABLE EXTENSION UNLOCKING LEVER |
| G. RIP FENCE | P. LEFT HAND SIDE TABLE EXTENSION UNLOCKING PINS - 1 FRONT, 1 REAR |
| H. RIP FENCE LOCKING HANDLE | |
| I. PUSH STICK STORAGE | |

WHAT'S IN THE BOX

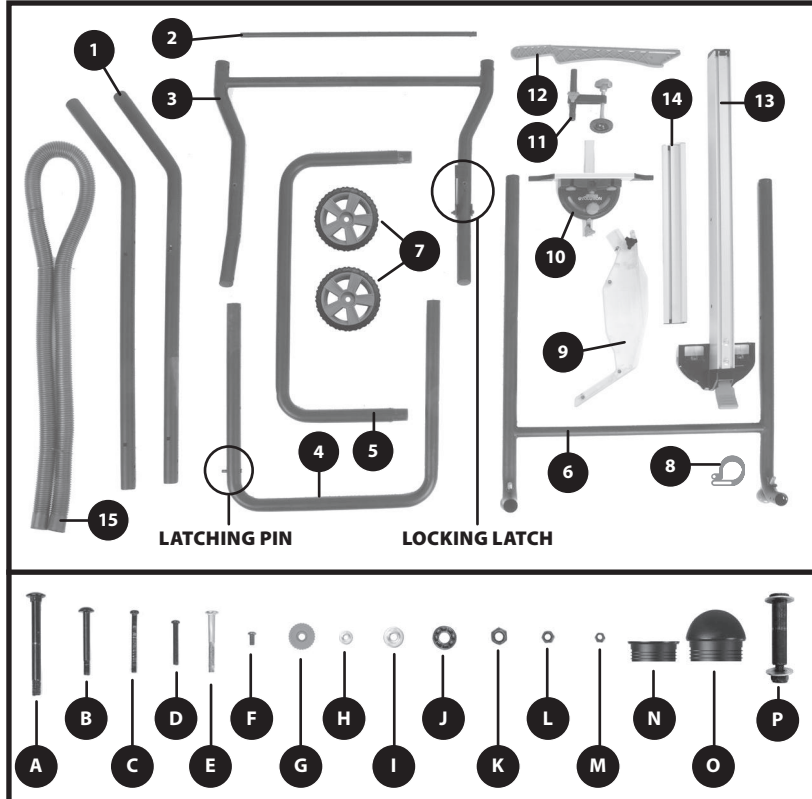

- | | | | |
|------------------------------|----|----------------------|----|
| 1. STAND COMPONENT | X2 | A. M8 X 78MM BOLT | X8 |
| 2. STAND COMPONENT | X1 | B. M6 X 53MM BOLT | X4 |
| 3. STAND COMPONENT | X1 | C. M5 X 50MM BOLT | X2 |
| 4. STAND COMPONENT | X1 | D. M5 X 40MM BOLT | X4 |
| 5. STAND COMPONENT | X1 | E. M6 X 55MM BOLT | X2 |
| 6. STAND COMPONENT | X1 | F. M5 X 10MM BOLT | X1 |
| 7. WHEELS | X2 | G. ORANGE FINGER NUT | X2 |
| 8. DUST EXTRACTION HOSE CLIP | X1 | H. SMALL WASHER | X2 |
| 9. BLADE GUARD | X1 | I. LARGE WASHER | X4 |
| 10. MITRE GAUGE | X1 | J. SPACER | X8 |
| 11. ANTI VIBRATION DEVICE | X1 | K. M8 NUT | X8 |
| 12. PUSH STICK | X1 | L. M6 NUT | X4 |
| 13. RIP FENCE | X1 | M. M5 NUT | X7 |
| 14. RIP FENCE FACE PLATE | X1 | N. FLAT END CAPS | X6 |
| 15. DUST EXTRACTION HOSE | X1 | O. ROUND END CAPS | X2 |
| | | P. WHEEL BOLTS | X2 |

ASSEMBLY

To assemble this saw you will need: Cross head screwdriver, 8mm & 10mm spanner or socket wrench, 13mm Socket wrench, 5mm allen key and a rubber mallet.

Note: This process can be considerably aided by studying the images of the assembled machine and the components found on the machine overview & what's in the box pages. Unpack all components including fixings and familiarise yourself with them before attempting to assemble the machine. Enlist competent help when assembling this machine. Use the rubber mallet to aid assembly.

THE BUILD PROCESS:

WARNING: This machine is heavy. Enlist competent help when moving or lifting this machine.

Step 1

- Align the table extension with the end of the rear slide rail. **(Fig. 1)**
- Adjust the front slide rail until the measuring indicator reads 0 on the ruler.
- Align the height of the table extension with the main table.
- Tighten the 4 screws located on the under side of the table extension.

Step 2

- Invert the main body of the machine and place on a clean, secure and sturdy workbench or similar **(Fig. 2)**.
- Select the two components labelled **1**.
- Attach the two components to the machines main body using fixings **B, I and L (Fig. 3)**.
- Select the two end caps labelled **O** and push them into the angled ends of the components.
- Select two end caps labelled **N** and push them into the straight ends of the components.

Step 3

- Select the components labelled **2** and **3**. Attach **2** to **3** using the fixings **C** and **M (Fig. 4)**.

Step 4

- Select the components labelled **3** and **4**.
- Attach component **4** to **3** using the fixings labelled **A, J** and **K**. Do not over tighten. Repeat on the other side. **(Fig. 5)**. Note the position of the spacers **J** which are required to provide the necessary clearance for the frame to operate.
- Ensure that component **4** is the right way round and that the latch on component **3** engages the latching pin on component **4** correctly **(Fig. 6)**.
- Select two end caps labelled **N** and push them into the ends of component **3**.

Step 5

- Attach component **4** in its service position on the machine. See that the position of the latching lever and pin is on the same side as the rise and fall/bevel adjustment hand wheel. **(Fig.7)**.
- Use fixings labelled **A, J** and **K** ensuring that the spacer **J** is correctly positioned to provide the necessary clearance for the frame to operate. Do not overtighten.
- Repeat on the other side. **(Fig. 8)**.

Step 6

- Select the components labelled **5** and **6**. Attach component **5** to **6** using the fixings labelled **D** and **M (Fig. 9)**.
- Select the remaining two end caps labelled **N** and push them into the straight ends of component **6**.

Step 7

- Attach component **3** to the rest of the leg assembly using the remaining fixings labelled **A, J** and **K (Fig. 10)**. It may help to move component **4** out of the way.
- Manoeuvre component **3** and **6** so the bolt holes line up. **(Fig. 11)**.

Step 8

- Attach the wheels **7** to their service position on component **3** using fixings **P (Fig. 12)**. Do not over tighten the wheels, as this will prevent them from moving freely.
- Enlist competent help in turning the table saw over. The stand assembly is now complete.

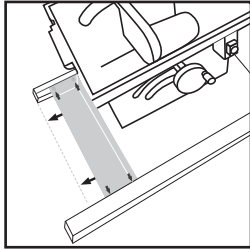

Fig. 1

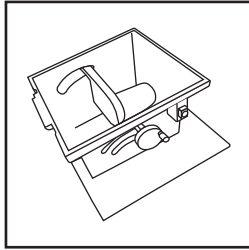

Fig. 2

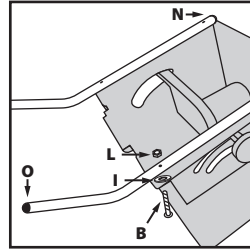

Fig. 3

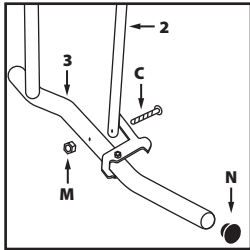

Fig. 4

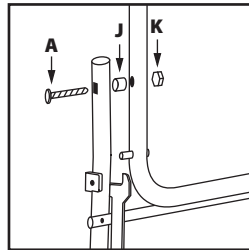

Fig. 5

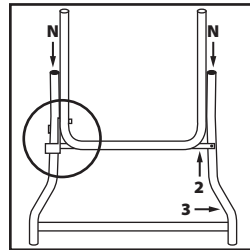

Fig. 6

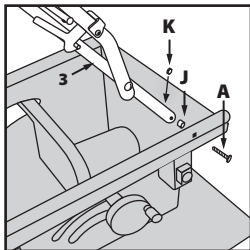

Fig. 7

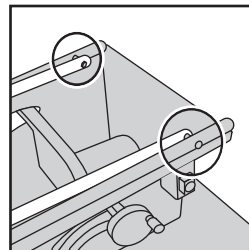

Fig. 8

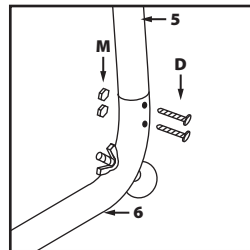

Fig. 9

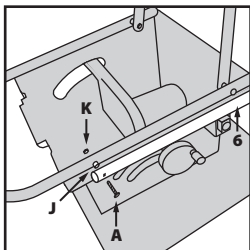

Fig. 10

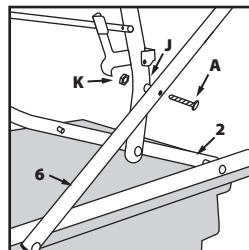

Fig. 11

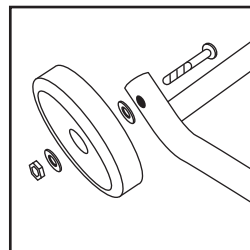

Fig. 12



Fig. 13

Some further minor assembly is required to commission this machine.

WARNING: This machine is heavy. Enlist competent help when removing this machine from its packaging.

DEPLOYING THE LEGS

The legs are stored underneath the machines main body.

- Release the retaining latch (**Fig 13**).
- Deploy the legs.
- Ensure that the legs are secured into their service position.
- The latch must deploy and lock the legs securely in their service position.

Note: This machine is heavy. Competent help should be enlisted when moving this machine. Competent help may also be required when deploying the leg assembly and/or storing the leg assembly underneath the machine.

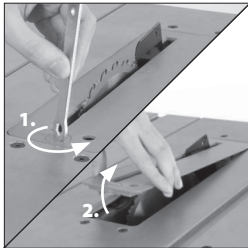

Fig. 14

THE RIVING KNIFE

The Riving Knife is a very important component, and must be fitted correctly.

The Riving Knife has two functions:

- It prevents the work-piece from binding as it passes through the blade.
- It provides a suitable connection point for the blade guard.

To fit and/or check the Riving Knife:

WARNING: Ensure that this procedure is only carried out with the machine disconnected from the mains supply.

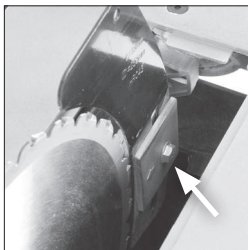

Fig. 15

- Remove the Table Access Plate by turning the fixing screw ¼ of a turn. Lift the Access Plate from the machine (**Fig. 14**). Carefully store this component for later use.
- Raise the blade to its highest position - See page 21 'RAISING/LOWERING THE BLADE' section.
- Loosen the Riving Knife fixing bolt by several turns and raise it to its highest point (**Fig. 15**).
- Slide the Riving Knife (it is slotted for convenience) between the fixing plate and mounting block (**Fig. 15**). Ensure that the mounting blocks projecting lugs engage with the slot in the Riving Knife.
- Adjust the Riving Knife so that it is between 3 – 5mm from the saw blade. The blade guard mounting hole on the riving knife should be at least 10mm higher than the tooth peak. (**Fig. 16**).
- When correct alignment is achieved tighten the fixing bolt.
- Check the saw blade rotates freely and teeth are within 3 - 5mm of the Riving Knife.
- Re-install the Table Access Plate.

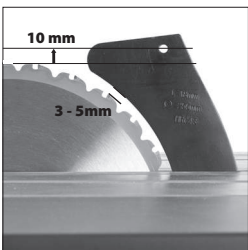

Fig. 16

THE BLADE GUARD

The Blade Guard labelled **9** must be attached to the machines riving knife.

Note: The machine should never be used without this guard in its service position.

WARNING: The machine must be disconnected from the mains supply when installing the blade guard.

To attach the Blade Guard

- Raise the blade to its full height to fully reveal the machines Riving Knife.
- The guards locating pin should be positioned through the hole machined in the Riving Knife and the washer and locking nut fitted to one side. The blade guard must move up and down easily and smoothly, so do not over-tighten this nut (**Fig. 17**).
- Check the operation of the blade guard. Ensure that it is working efficiently and covers the crown of the blade.
- Lower the blade a little and recheck that the blade guard operation.
- When satisfied that the blade guard works throughout the blades height adjustment range, check that the guard works equally well with the blade at a bevel angle (**Fig 18**).
- Check that when the blade is fully lowered, the blade guard is in contact with the table top.

THE RIP FENCE

This machine has a two (2) piece Rip Fence.

The Rip Fence Face Plate labelled **14** must be attached to the Rip Fence labelled **13** using the fixings **E** and **G**.

- Insert the bolts **L** through the holes on the LH side of the Rip Fence and loosely tighten the finger nut **G** on the RH side.
- Slide the Rip Fence Face Plate onto the Rip Fence over the heads of the bolts (**Fig. 19**).
- Tighten the two finger nuts.

To attach the Rip Fence:

- Hook the rear of the Rip Fence Guide over the rear Rip Fence Rail.
- With the handle in its upper position, locate the front of the Rip Fence over the front Rip Fence Rail.
- Push the handle down to lock the Rip Fence in place (**Fig. 20**).

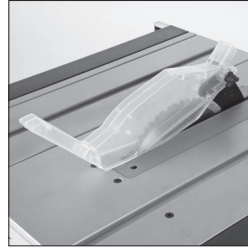

Fig. 17

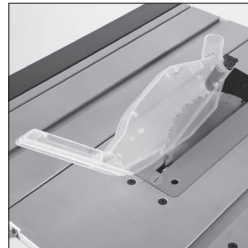

Fig. 18



Fig. 19

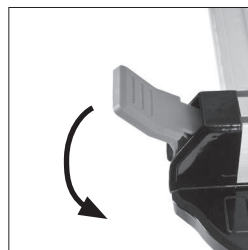

Fig. 20

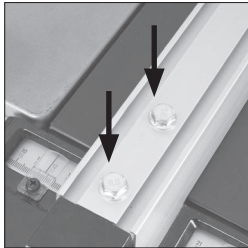

Fig. 21

CHECKING/ADJUSTING THE RIP FENCE

When the Rip Fence has been attached to the machine, the Rip Fence should be checked to ensure that it lies parallel to the blade.

- Raise the blade to its full height.
- Rest a straight-edge or similar against the blade.
- Bring the Rip Fence up to the straight-edge and check for parallelism.
- If adjustment is needed, gain access to the two hex headed screws located on the Rip Fence (**Fig. 21**).
- Loosen these screws slightly using a suitable wrench, and adjust the fence as required.
- Tighten and re-check the Rip Fence when correct alignment has been achieved.
- Lower the blade.

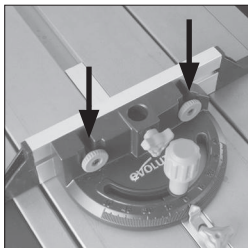

Fig. 22

THE MITRE GAUGE

The Mitre Gauge labelled **10** has an adjustable Face Plate and provision for a Hold Down Clamp labelled **11**.

- Insert the Hold Down Clamp into the socket in the Mitre Gauges main body and tighten the locking screw.
- Attach the Face Plate of the Mitre Gauge.
- Slide the attachment screws through the two (2) holes in Mitre Gauges vertical face and secure in place with the thumb nuts (**Fig. 22**).
- The Mitre Gauge is usually employed on the LH side of the table and runs in an inverted T slot in the table top.
- The Mitre Gauge can be locked onto the Sliding Carriage by screwing the locking screw into a hole located to the front edge of the Sliding Carriage (**Fig 23**).

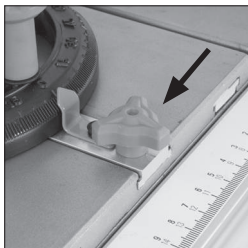

Fig. 23

DUST EXTRACTION

- Attach one end of the hose to the blade guard.
- Attach the dust extraction hose clip to the rear of the RH (right hand) side table extension using the fixings labelled **F, H** and **M** (**Fig. 24**).
- Run the hose through the clip to the port on the rear of the machine.

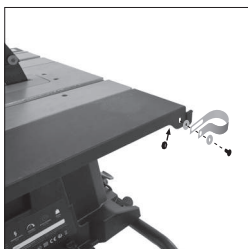

Fig. 24

TRANSPORTING YOUR TABLE SAW

WARNING: Ensure that this procedure is only carried out with the machine disconnected from the mains supply.

- Ensure that the machine is disconnected from the mains supply and that the power cord is securely stored on the machine.
- Release the latching pin.
- Grasp the transportation handle (**Fig. 25**).
- Gently and slowly lift the handle, allowing the machine to maintain balance and stability.
- Wheel the machine to its new location.

OPERATIONS

THE CONTROLS

ON/OFF SAFETY SWITCH

WARNING: Before operating the ON/OFF switch make sure that the blade guard is correctly installed and operating properly.

- Push the 'ON' button to start the machine. **(Fig. 26)**
- Push the 'OFF' button to stop the machine.
- This machine is fitted with a motor overload safety feature. If the motor is overloaded, the overload switch will be triggered causing the motor to stop. If this happens, press the overload button located above the on/off button to reset the machine. **(Fig. 26)**

WARNING: Never start the machine until all safety checks and procedures have been carried out.

RAISING/LOWERING THE BLADE

WARNING: Only make adjustments to the machine when the machine is switched OFF and the blade is stationary.

Note: This machine is equipped with a dual function hand-wheel. In its 'normal' (outer) position the hand-wheel is used to raise or lower the blade. When the hand-wheel is pushed in against its bias spring it engages with the curved toothed rack incorporated in the machines main body. This allows the hand-wheel to be used to adjust the tilt/bevel angle of the blade.

To raise or lower the blade:

- Ensure that the hand-wheel is in its 'normal' position.
- Turn counter clockwise to lower the blade **(Fig. 27)**.
- Turn clockwise to raise the blade.

TILTING THE BLADE

The blade can be tilted up to 45° to the left.

- Loosen the tilt locking mechanism by operating (opening) the tilt locking lever **(Fig. 28)**.
- Push the hand-wheel in against its bias spring until it engages with the tilt rack.
- Use the hand-wheel to set the required angle. An angle gauge to aid setting can be found behind the hand-wheel.
- Operate (close) the tilt locking lever when the required angle is achieved.
- Allow the hand-wheel to return to its 'normal' position.

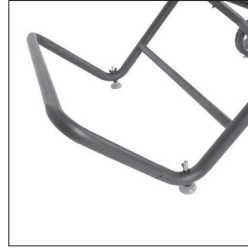

Fig. 25



Fig. 26



Fig. 27



Fig. 28



Fig. 29

THE RIP FENCE

This machine is fitted with a two piece Rip Fence. We recommend that the Rip Fence is normally used in conjunction with its adjustable Face Plate.

The Rip Fence should normally be positioned to the RH side of the blade. It is locked in position by using the locking lever. Push down to lock, and pull up to unlock.

Forwards and backwards adjustment of the Rip Fence Face Plate is possible. Loosen the finger nuts and slide the Rip Fence Face Plate to the desired position. Tighten the wing nuts securely (**Fig. 29**).

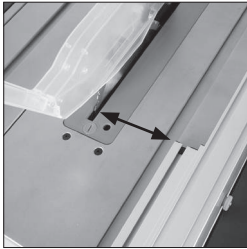

Fig. 30

We recommend you adjust and align the back of the Rip Fence Face Plate level with the front of the saw blade (**Fig. 30**).

THE DUAL READ SCALE

This machine has a dual read scale that shows the distance from the blade to the Rip Fence through a viewing window. This can be used to aid setting the cutting distance from the blade to the Rip Fence. With the Rip Fence Face Plate attached, use the black scale to set the distance of the Rip Fence. If you should need to use the Rip Fence without the Face Plate, use the orange scale.

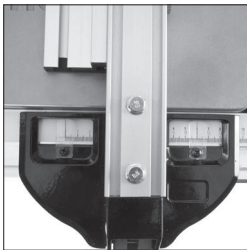

Fig. 31

Note: When using the Rip Fence to the LH side of the blade use the left viewing window to read the scales. When using the Rip Fence to the RH side of the blade, use the right viewing window to view the scale (**Fig. 31**). The scale should be regarded as a useful guide. It is not a substitute for careful and accurate 'marking out'.

THE MITRE GAUGE

The Mitre Gauge can be used on either side of the table and runs in inverted 'T' slots machined into the Sliding Carriage and the table top (RH).

Turn the vertical handle counter-clockwise to unlock the Mitre Gauge, and adjust to the required mitre angle. Turn the handle clockwise to lock the Mitre Gauge at the chosen angle.

The Mitre Gauge can be locked into the Sliding Carriage by tightening the Mitre Gauge Slide Locking Screw (**Fig. 32**).

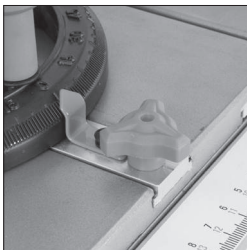

Fig. 32

Note: The face plate of the mitre gauge should be adjusted so that it passes close to, but does not touch the blade guard as it slides past during a cut.

Adjust by loosening the finger nuts and sliding the faceplate to the required position. Securely tighten the finger nuts (**Fig. 33**).

Note: The Mitre Gauge can be set at any angle between 60° Left and 60° Right.

MULTIFUNCTION TABLE TOP

This Table Saw is equipped with a versatile and adaptable table top. The various adjustments are designed to aid operator efficiency and safety.

TABLE EXTENSIONS

The table top can be extended to the RH and to the LH sides creating valuable extra work-piece support when cutting large or wide boards etc. Both sides of the table can be extended at the same time, or just one side at a time as required operationally.

To extend the table to the RH side:

- Pull up the Rip Fence locking lever and ensure that the Rip Fence is free to move.
- Alternatively it may be convenient to temporarily remove the Rip Fence from the machine.
- Pull up the table extension locking lever found under the table on the right. (**Fig. 34**).
- Deploy the table extension to give the required work-piece support.
- Push the locking lever down to lock the table in the required position.
- Re-attach and/or adjust the Rip Fence as required.
- When cutting is completed return the table to its original setting.

To extend the table to the LH side:

- Loosen the two locking screws (one to the front and one to the rear of the machine) underneath the LH side of the machines table (**Fig. 35**).
- Deploy the table extension.
- Tighten the locking screws.
- When cutting is completed return the table to its original setting.

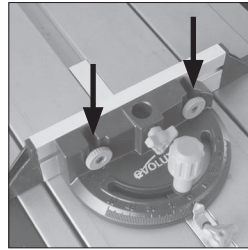

Fig. 33



Fig. 34



Fig. 35

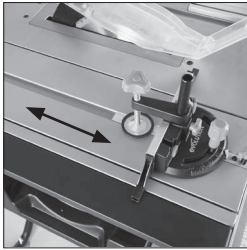

Fig. 36

SLIDING CARRIAGE

This machine is fitted with a Sliding Carriage (**Fig. 36**) to the LH side of the blade. This facility can be particularly useful when cross-cutting small section material such as metal box-section or extrusions etc.

Such material can be clamped to the Sliding Carriage by using the secured Mitre Gauge and its Hold Down Clamp. Operator control and safety are thereby enhanced.

The Sliding Carriage system can also be very useful (when used in conjunction with a secured Mitre Gauge) for repetitive cross-cutting.

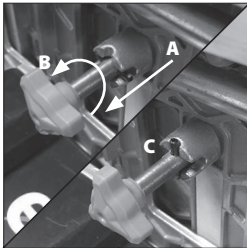

Fig. 37

TO USE THE SLIDING CARRIAGE

WARNING: The machine must be switched off, the blade stationary, and the switch cover plate in the closed (safe) position whenever adjustments etc are being made to the machine or the work-piece.

Lock the Mitre Gauge onto the Sliding Carriage by screwing the locking screw into the locating hole found to the front edge of the carriage (**Fig. 32**).

Adjust the Mitre Gauge Face Plate to ensure that it passes the blade and blade guard as it travels past both during a cut.

Unlock the pin under the Sliding Carriage by pulling out the knob (**Fig. 37 A**) and turning it 90° (**Fig. 37 B**), allowing it to rest in its unlocked position (**Fig. 37 C**). Using the Mitre Gauge as a hand hold, gently push the carriage rearwards to make a cut (**Fig. 38**).

To lock the Sliding Carriage again, reverse the unlocking motion.

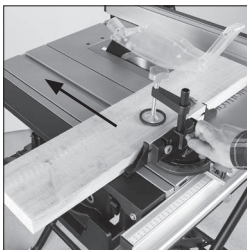

Fig. 38

BASIC TABLE SAW OPERATIONS

WARNING: Never attempt freehand cuts on this machine. Always use the appropriate guide or fence to minimise the possibility of the blade binding and kickback.

We recommend that the saw blade protrudes through the material to be cut by approximately 3mm. Adjust the height of the blade as previously described. This machine is not suitable for cutting rebates or stopped grooves.

A vacuum cleaner or workshop dust extraction device can be connected to the extraction port found at the rear of the machine if required (**Fig. 39**).

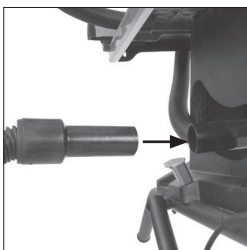

Fig. 39

CROSSCUTTING

Set the Mitre Gauge to 0° and tighten the vertical locking screw.

If employing the Sliding Carriage position the Mitre Gauge in the LH 'T' slot and lock it in place by screwing the locking screw into the locating hole.

Note: The Mitre Gauge can be used on the RH side of the blade if required. If so it will run 'freely' in the inverted 'T' slot found on the RH side of the table.

Adjust the Mitre Gauge Face Plate to ensure clearance as it passes the blade and blade guard during a cut.

Hold the material to be cut against the Mitre Gauge Faceplate. Switch on the saw and allow to reach full operating speed before sliding the mitre gauge and work-piece towards the rear of the table making your cut (**Fig. 40**).



Fig. 40

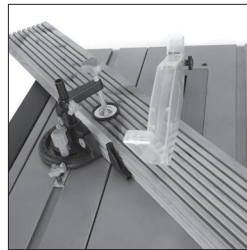

Fig. 41

MITRE CROSSCUTTING

Mitre crosscutting is cutting the work-piece at an angle of other than 90°. Set the Mitre Gauge to the desired angle (**Fig. 41**), tighten and proceed as cross-cutting above.

BEVEL CROSSCUTTING

Bevel crosscutting is the same as crosscutting but with the blade tilted at an angle.

Tilt the blade to the desired angle as previously described, and ensure that it is locked in place.

Set the Mitre Gauge to 0° and adjust the faceplate so that it will not touch or foul the saw blade or blade guard as it travels past.

Hold the work-piece against the Mitre Gauge and make your cut (**Fig. 42**).

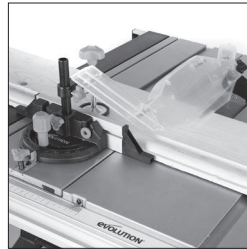

Fig. 42

COMPOUND MITRE CUTTING

Compound mitre cutting is a combination of mitre cutting and bevel crosscutting.

Adjust the mitre gauge and the blade to the desired angles. Lock both in place.

Check that the mitre gauge will pass the saw blade without fouling. Adjust the mitre gauge faceplate if necessary.

Index the material against the mitre gauge and make your cut (**Fig. 43**).



Fig. 43

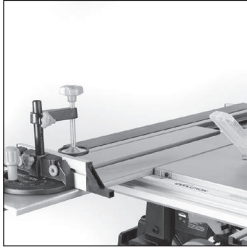

Fig. 44

REPETITIVE CROSS CUTTING

Repetitive Cross Cutting is the process of cutting a number of pieces to the same length without having to mark out each piece separately.

Note: We recommend that repetitive cross-cutting is carried out with the Mitre Gauge positioned on the LH side of the machine, with the Rip Fence on the RH side of the machine (**Fig. 44**).

WARNING: The Rip Fence can be used as a length stop only as long as it is properly set and adjusted.

To set the Rip Fence for Repetitive Cross Cutting:

- Set the Rip Fence at the required distance from the saw blade.
- We recommend you adjust and align the back of the Rip Fence faceplate level with the front of the saw blade (**Fig. 45**).

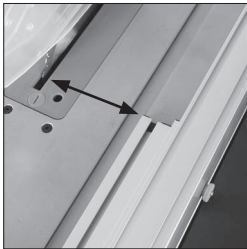

Fig. 45

This setting will afford clearance for the material as it passes through the saw blade. It will allow the cut material to move sideways away from the saw blade, with little risk of any binding or kickback occurring.

Index and hold the material to be cut against the Mitre Gauge faceplate and the also index the material gently against the Rip Fence. Hold the material and Mitre Gauge securely with your left hand. Gently push the workpiece through the saw. Use a push stick, if necessary, in your right hand to guide the workpiece on the RH side of the blade.

RIP CUTTING

Rip cutting is cutting along the length of a piece of material rather than across it.

Rip cutting should always be done with the Rip Fence Face set to the desired width and on the RH side of the machines table.

The Mitre Gauge is not required for this operation, and should be stored safely off the machine for future use.

Note: Check that the Rip Fence is locked in position and is parallel to the saw blade.

Check that the Riving Knife is properly aligned with the saw blade.

When ripping small section material a push stick should be used to feed/guide the final 300mm of the material past the blade. a push stick should always be used when making cuts of less than 300mm.

When ripping long boards or large panels always use a remote work support or enlist trained competent help.

Feed the work-piece through the saw keeping it indexed against the Rip Fence. Use smooth, steady pressure and employ a push stick if necessary (**Fig. 46**).

When the ripping width is greater than 300mm, with care, both hands can be used to guide/feed the material through the saw. The operators left hand will be to the LH side of the saw blade. The operators right hand will be close to the Rip Fence on the RH side of the saw blade. Hands should **never** be in line with the blade.

BEVEL RIPPING

When bevel ripping material 150mm or narrower use the Rip Fence on the RH side of the blade only.

PUSH STICK

A plastic push stick, labelled **14** is provided with the machine and has its own dedicated storage brackets to the RH side of the machines main body (**Fig. 47**). When not in use store the push stick on the machine.

Note: If the push stick becomes damaged it should be replaced. If the operator makes their own push stick, we recommend that it follows the same pattern as that supplied. (Replacement push sticks are available from Evolution Power Tools.)

MAINTENANCE

WARNING: Ensure that the machine is disconnected from the mains supply before any maintenance tasks or adjustments are attempted.

CHANGING THE BLADE

Note: We recommend that the operator considers wearing protective gloves when handling or changing the machines blade.

- Disconnect the machine from the power supply
- Remove the top blade guard. (**refer to BLADE GUARD on page 19**)
- Remove the access plate by turning the locking screw $\frac{1}{4}$ of a turn and gently ease the access plate from the table (**Fig. 48**). Safely store the access plate for future use.
- Raise the blade to its highest position.
- Use the two blade changing tools provided. One to hold the motor arbor, and the other to remove the arbor nut (**Fig. 49**).
- Remove the nut, outer flange and blade.



Fig. 46

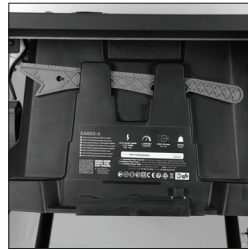

Fig. 47

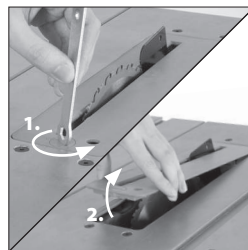

Fig. 48

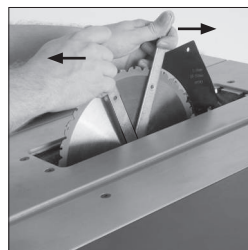

Fig. 49

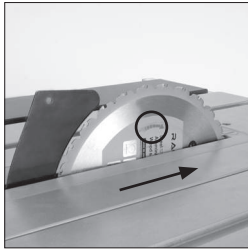

Fig. 50

- Fit the new blade. Ensure that the teeth are facing to the front of the saw, and that the arrow on the blade is in line with the motor direction (**Fig. 50**).
- Replace the outer flange and nut and tighten securely with the spanners provided. Check that both blade flanges are in contact with the blade.
- Replace the access plate and its fixing screw. Ensure that the fixing screw is correctly seated.
- Replace the Blade Guard and check all operational functions of the blade and its guarding system.
- Only connect the machine to its main supply after a complete safety check of the machine has been carried out.

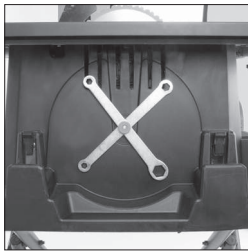

Fig. 51

THE RIVING KNIFE

The riving knife is a very important component and must be fitted correctly aligned and adjusted. The riving knife prevents the work from binding as it passes through the blade.

Inspect the riving knife at regular intervals and replace it if it is worn or damaged.

Note: Use only a genuine **Evolution Riving Knife**, as this is a dedicated component for this machine. Non genuine parts could be dangerous. If in **any doubt**, please contact the **Helpline**.

CLEANING

After each use the machine should be cleaned. Remove all sawdust, etc. from the visible parts of the machine with a vacuum cleaner. A vacuum cleaner can also be connected to the machine dust extraction port at the rear of the machine. This should remove debris from the inside of the machine. Never use solvents to clean plastic parts, as solvents can damage them. Clean only with a soft very slightly damp cloth.

TOOL STORAGE

A tool storage facility is available at the LH side of the machine (**Fig. 51**). Undo the centre hand nut and place the blade changing tools onto the metal flange. Secure the tools with the centre finger nut.



ENVIRONMENTAL PROTECTION

Waste electrical products should not be disposed of with household waste. Please recycle where facilities exist. Check with your local authority or retailer for recycling advice.

EC DECLARATION OF CONFORMITY

In accordance with EN ISO 17050-1:2004



The manufacturer of the product covered by this Declaration is:

UK: Evolution Power Tools Ltd. Venture One, Longacre Close, Holbrook Industrial Estate, Sheffield, S20 3FR.

FR: Evolution Power Tools SAS. 61 Avenue Lafontaine, 33560, Carbon-Blanc, Bordeaux, France.

The manufacturer hereby declares that the machine as detailed in this declaration fulfils all the relevant provisions of the Machinery Directive and other appropriate directives as detailed below. The manufacture further declares that the machine as detailed in this declaration, where applicable, fulfils the relevant provisions of the Essential Health and Safety requirements.

The Directives covered by this Declaration are as detailed below:

2006/42/EC.	Machinery Directive.
2014/30/EU.	Electromagnetic Compatibility Directive.
2011/65/EU. & 2015/863/EU.	The Restriction of the Use of certain Hazardous Substances in Electrical Equipment (RoHS) Directive.
2012/19/EU.	The Waste Electrical and Electronic Equipment (WEEE) Directive.

And is in conformity with the applicable requirements of the following documents:

**EN 62841-1:2015 • EN 62841-3-1: 2014/A11: 2017 • EN 55014-1: 2017
EN55014-2:2015 • EN61000-3-2:2014 • EN61000-3-11: 2000 • AfPS GS 2019:01 PAK**

Product Details

Description: RAGE5-S 255mm (10") MULTI-MATERIAL TABLE SAW
Evolution Model No: 220v-240v: 057-0001 / 057-0003
110v: 057-0002

Brand Name: EVOLUTION
Voltage: 220-240v / 110v~ 50Hz - UK, EU, AU
120v ~ 60Hz - US
Input: S1 1500W S6 40% 1800W (220v-240v) 1600W / 14.5A (110v / 120v)

The technical documentation required to demonstrate that the product meets the requirements of directive has been compiled and is available for inspection by the relevant enforcement authorities, and verifies that our technical file contains the documents listed above and that they are the correct standards for the product as detailed above.

Name and address of technical documentation holder.

Signed:  Print: Barry Bloomer: Supply Chain & Procurement Director

Date: 20.03.19

The place of keeping technical documents:

UK: Evolution Power Tools Ltd. Venture One, Longacre Close, Holbrook Industrial Estate, Sheffield, S20 3FR.

FR: Evolution Power Tools SAS. 61 Avenue Lafontaine, 33560, Carbon-Blanc, Bordeaux, France.

evOLUTION®

evolutionpowertools.com

AUS

Total Tools (Importing) Pty Ltd
20 Thackray Road
Port Melbourne
Vic 3207

T: 03 9261 1900

FR

Evolution Power Tools SAS
61 Avenue Lafontaine
33560, Carbon-Blanc
Bordeaux

T: +33 (0)5 57 30 61 89

UK

Evolution Power Tools Ltd
Venture One, Longacre Close
Holbrook Industrial Estate
Sheffield, S20 3FR

T: +44 (0)114 251 1022

USA

Evolution Power Tools LLC
8363 Research Drive
Davenport, IA
52806

T: 833-MULTI-SAW (Toll Free)

DE +44 (0)114 251 1022

ES +34 91 114 73 85

NL +44 (0)114 251 1022

PL +48 33 821 0922

PT +34 91 114 73 85

RO +44 (0) 114 2050458

RU +7 499 350 67 69

TR +90 (0) 312 9001810



EPT QR CODE

V15 - BK1