

ALBA

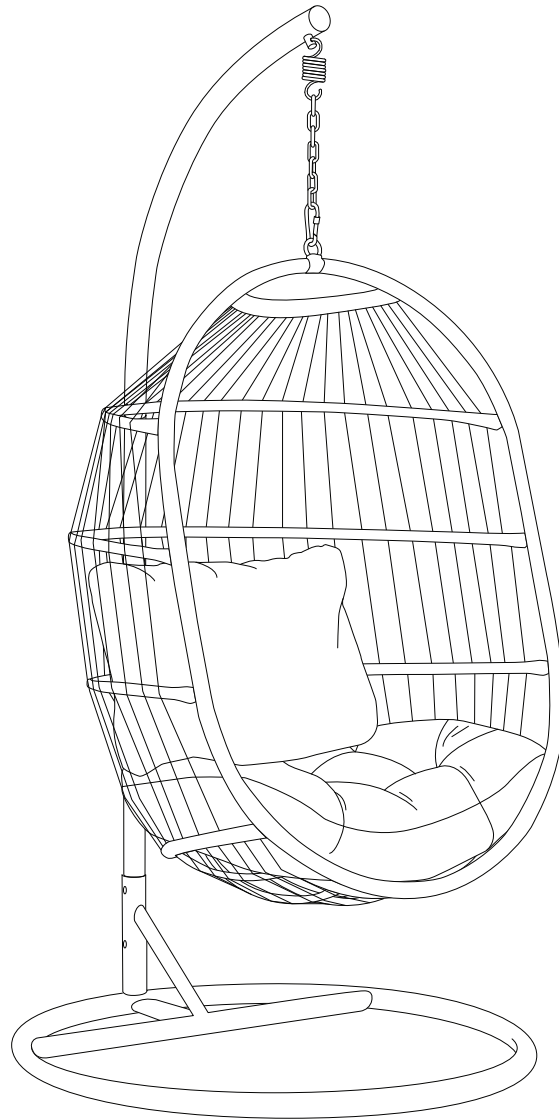

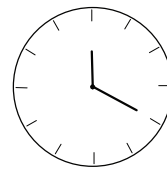

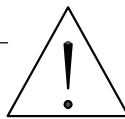

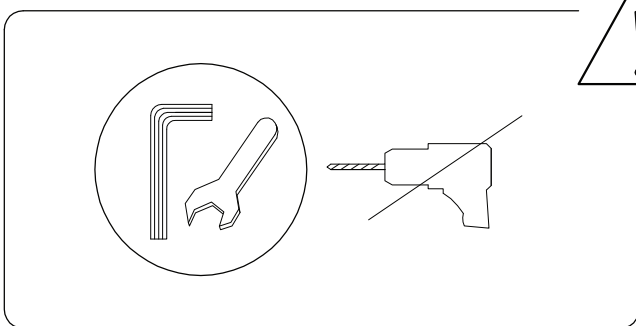
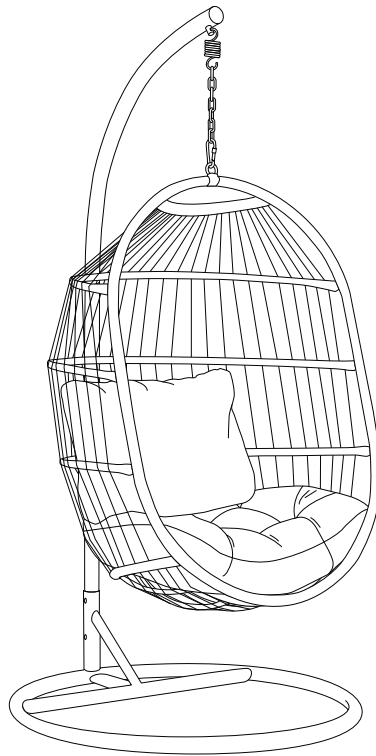
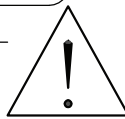
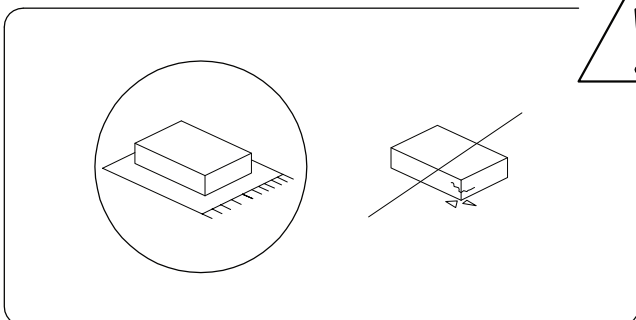

20'

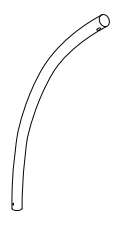

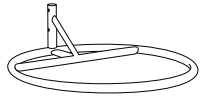
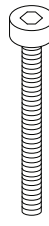
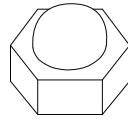
1

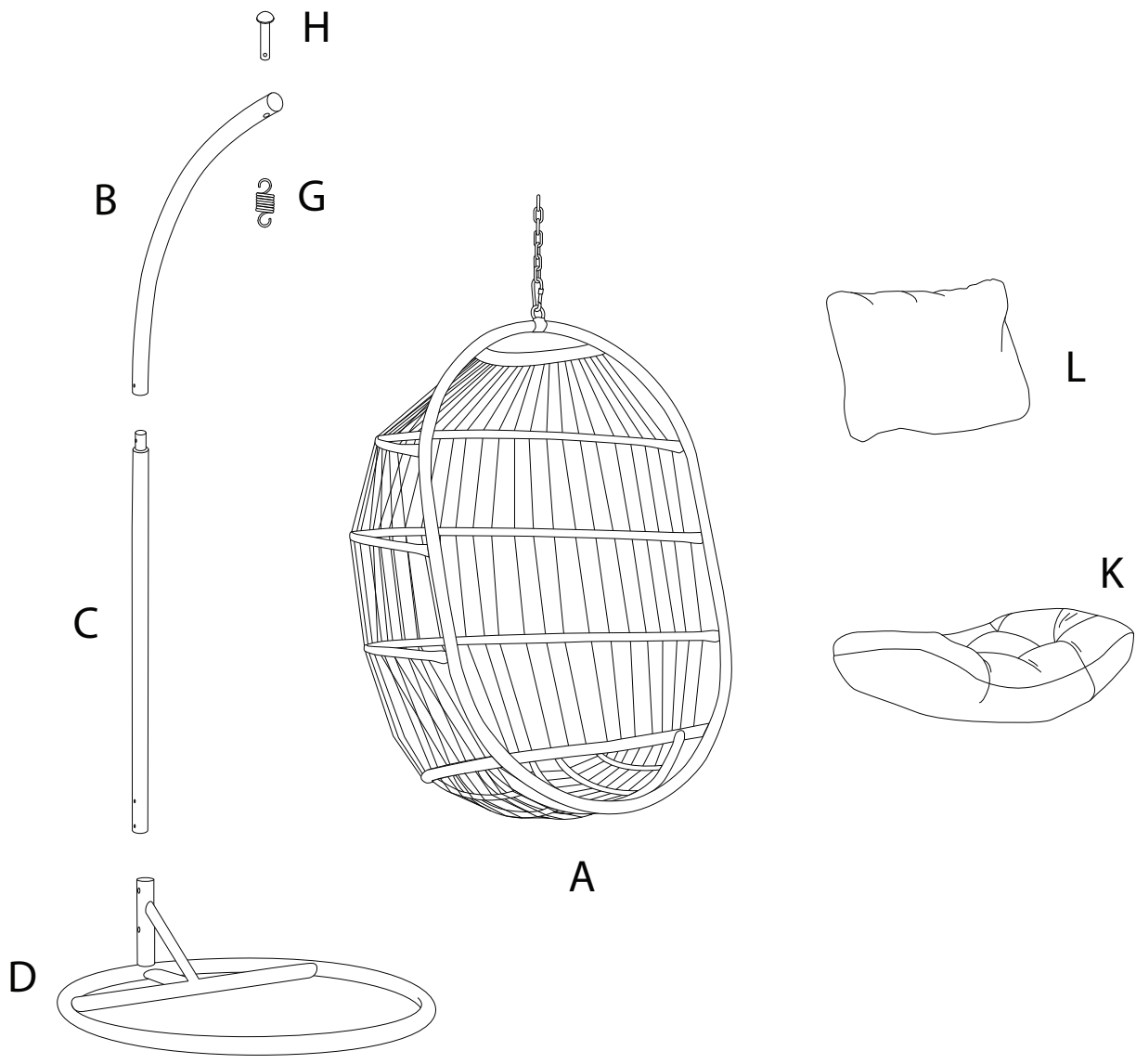
<p>A</p>  <p>x 1</p>	<p>B</p>  <p>x 1</p>	<p>C</p>  <p>x 1</p>	<p>D</p>  <p>x 1</p>	<p>E</p>  <p>M10 x 60</p> <p>x 3</p>	<p>F</p>  <p>x 3</p>
---	---	---	--	---	---

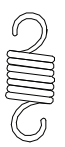

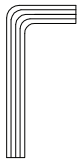
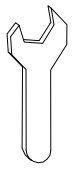
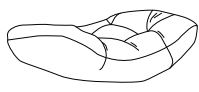
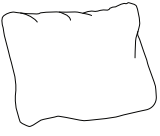
<p>G</p>  <p>x 1</p>	<p>H</p>  <p>x 1</p>	<p>I</p>  <p>x 1</p>	<p>J</p>  <p>x 1</p>	<p>K</p>  <p>x 1</p>	<p>L</p>  <p>x 1</p>
---	---	---	---	---	---

1

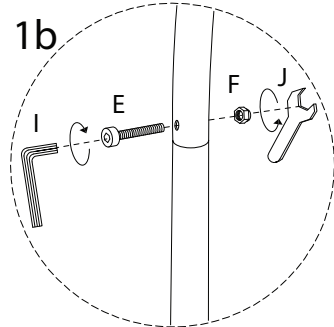
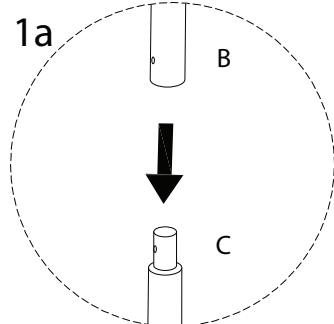
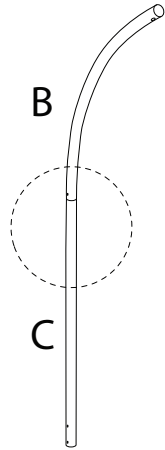
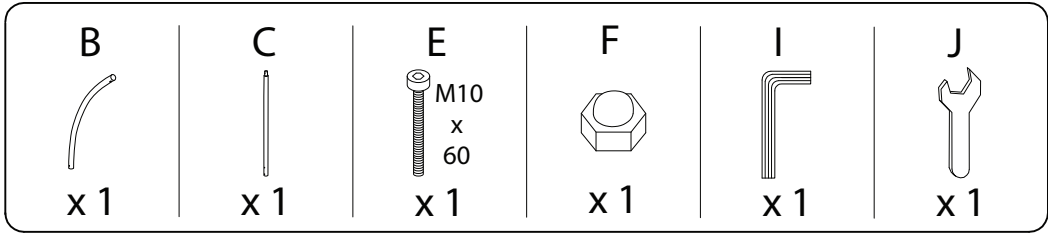

2

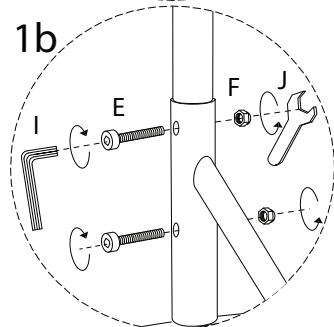
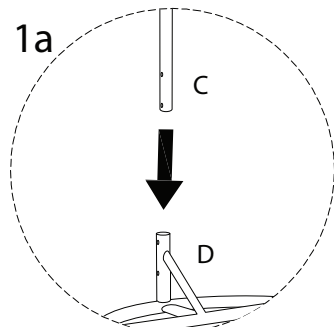
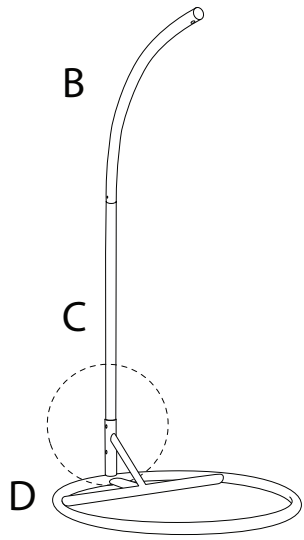
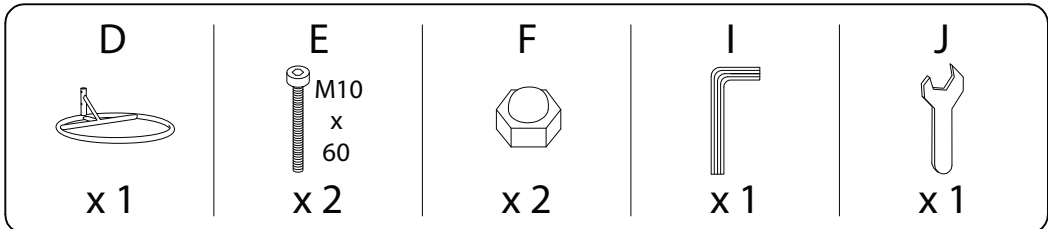

3

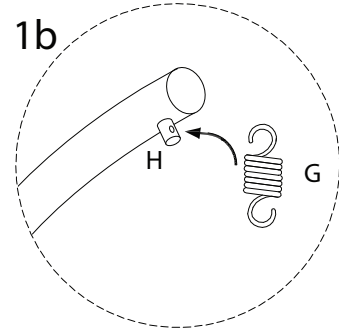
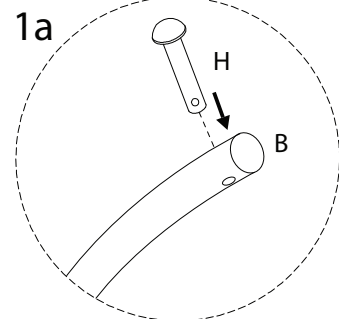
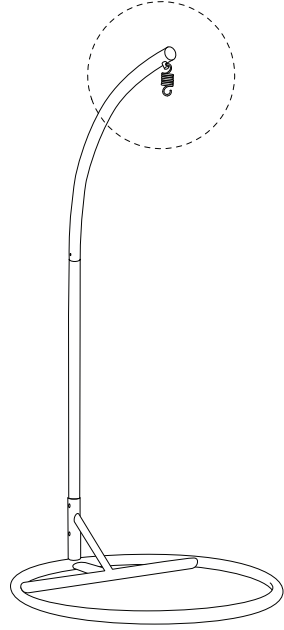
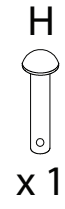

4

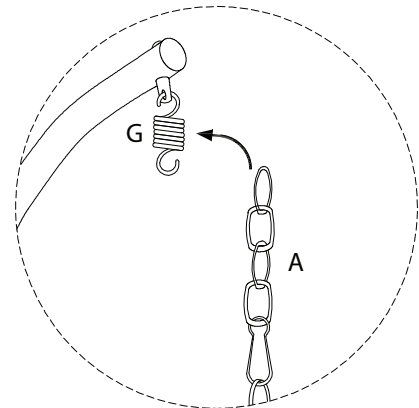
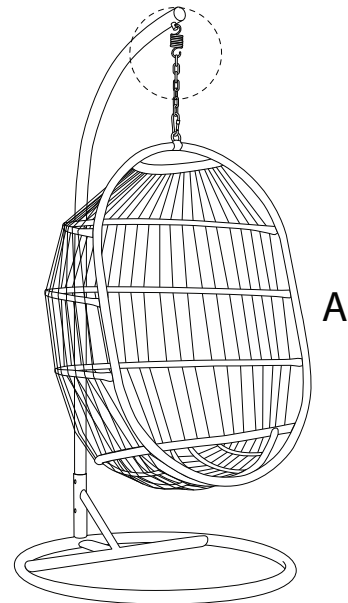

5

K

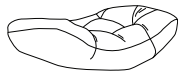

x 1

L



x 1

