

BOUDECH

CARRELLO DA GIARDINO CON RIMORCHIO RIBALTABILE
MDL TC1255 250KG

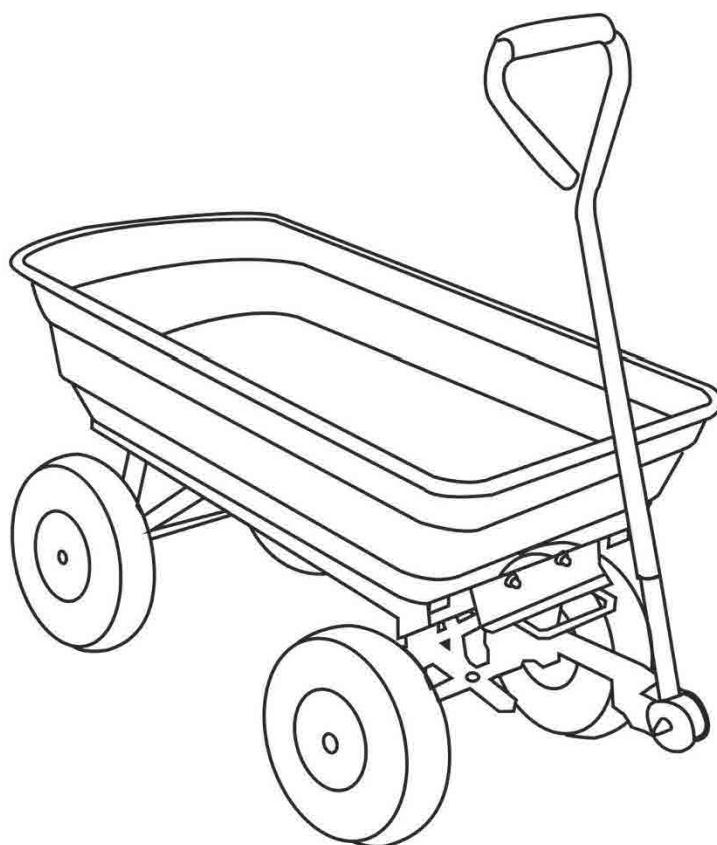

ITALIAN MANUAL



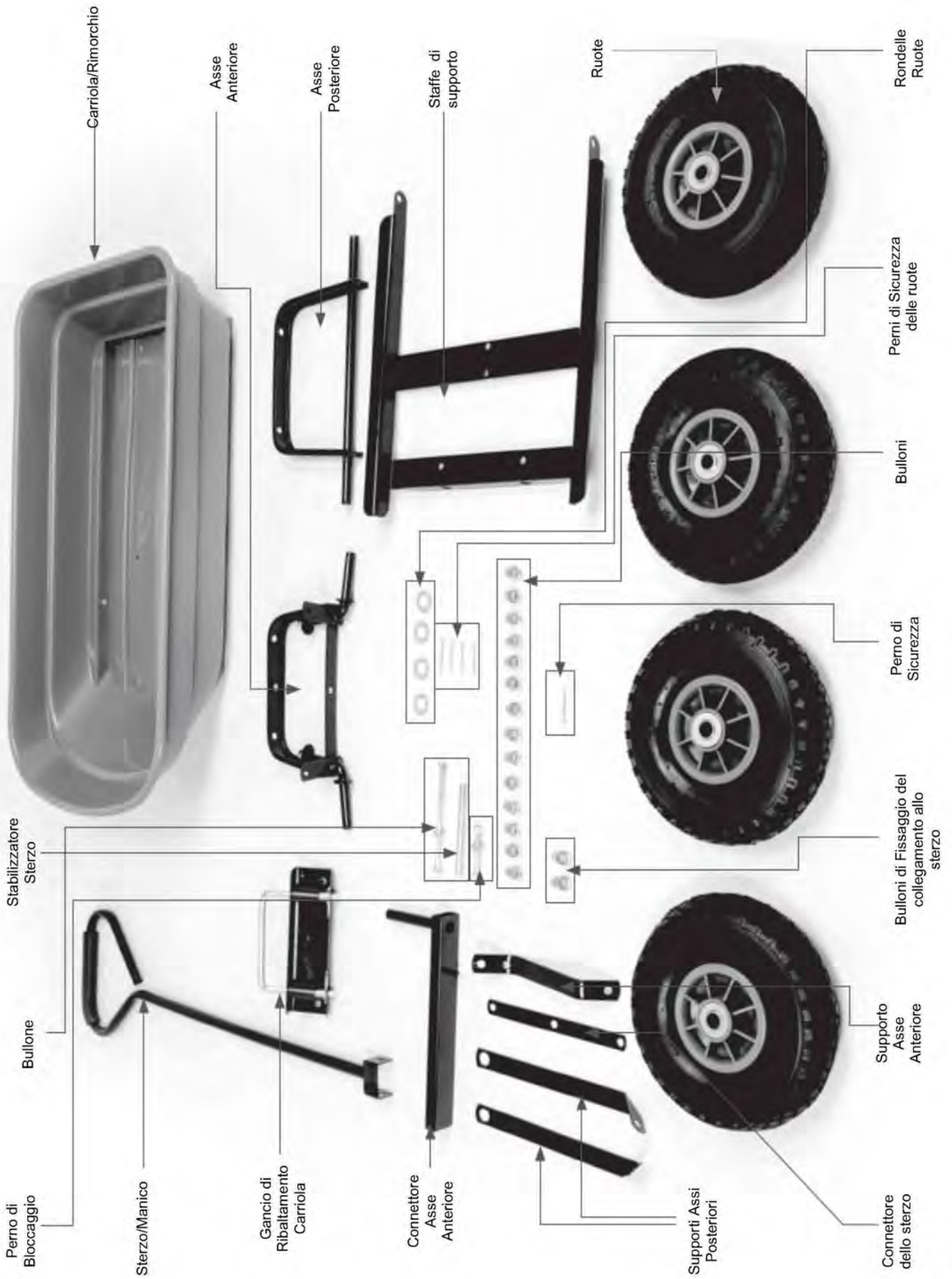

- 1** Inserire lo stabilizzatore dello sterzo nella protuberanza cilindrica del connettore dell'asse anteriore



- 2** Installare il connettore precedentemente assemblato sull'asse anteriore



- 3** Posizionare il supporto dell'asse anteriore sul lato inferiore della leva trasversale dell'asse in corrispondenza della protuberanza cilindrica e fissarla utilizzando il bullone dello sterzo e la rispettiva coppia di rondella e bullone fornita in dotazione

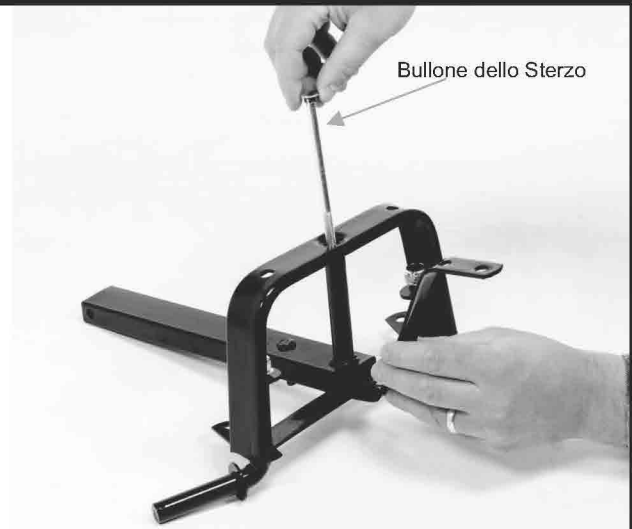

- 4** Posizionare i due fori del connettore dello sterzo in concomitanza dei due fori presenti sugli angolari dell'asse e fissarlo utilizzando rondelle e bulloni forniti in dotazione

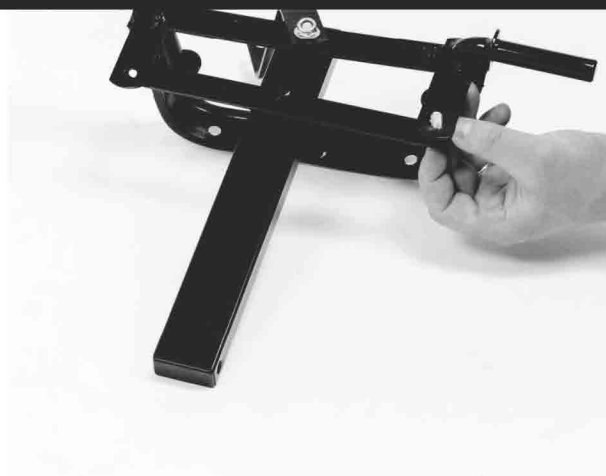
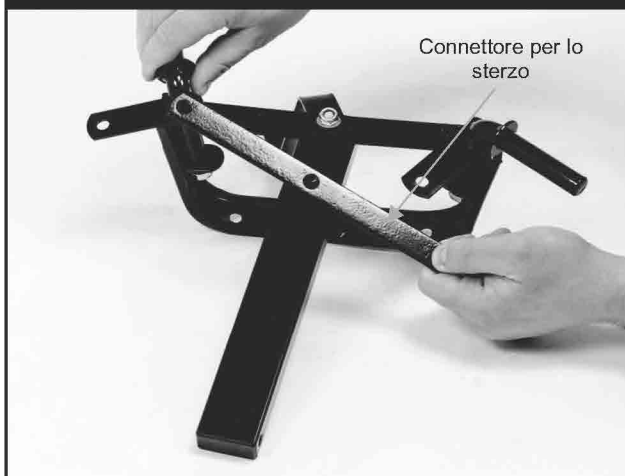

- 5** Posizionare il perno di sicurezza tra il connettore dell'asse ed il connettore dello sterzo



- 6** Dilatare le estremità del perno di sicurezza utilizzando una pinza ed assicurandone il bloccaggio.



7

Posizionare l'asse posteriore sul rimorchio e fissarlo utilizzando i bulloni in dotazione

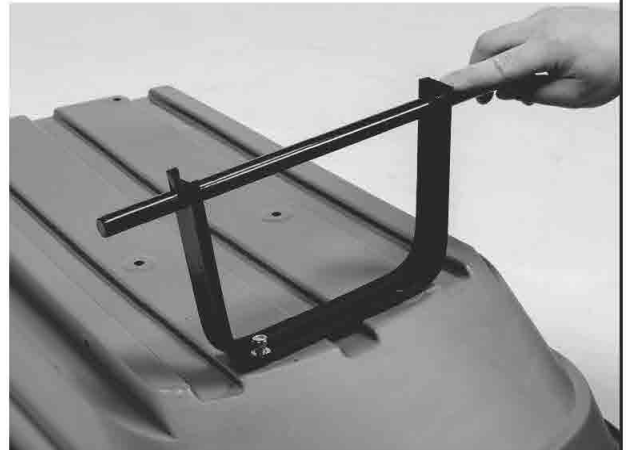
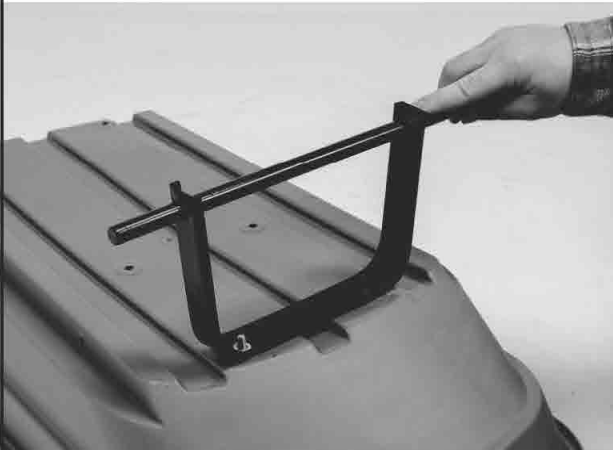
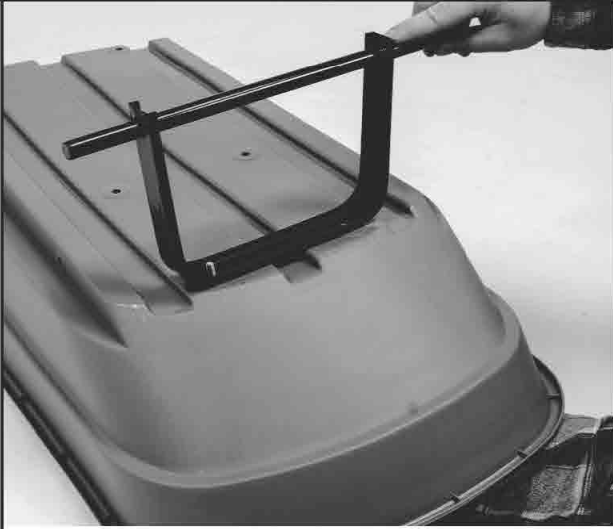

8

Installare i supporti all'asse posteriore utilizzando i bulloni e le rondelle in dotazione

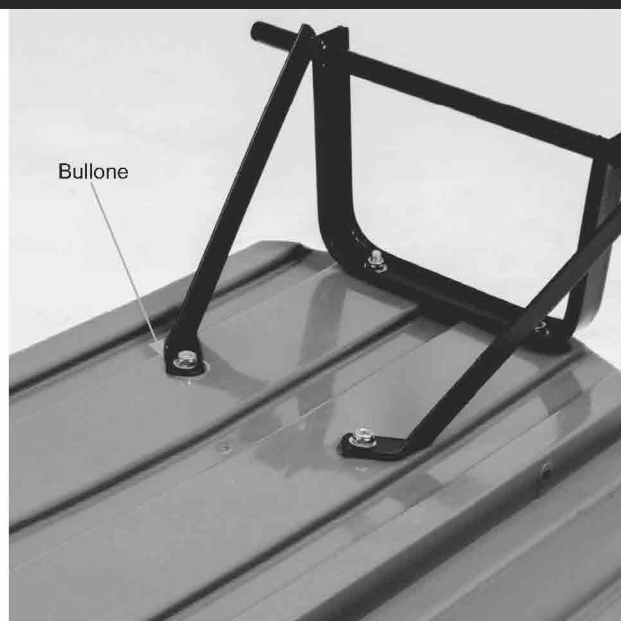
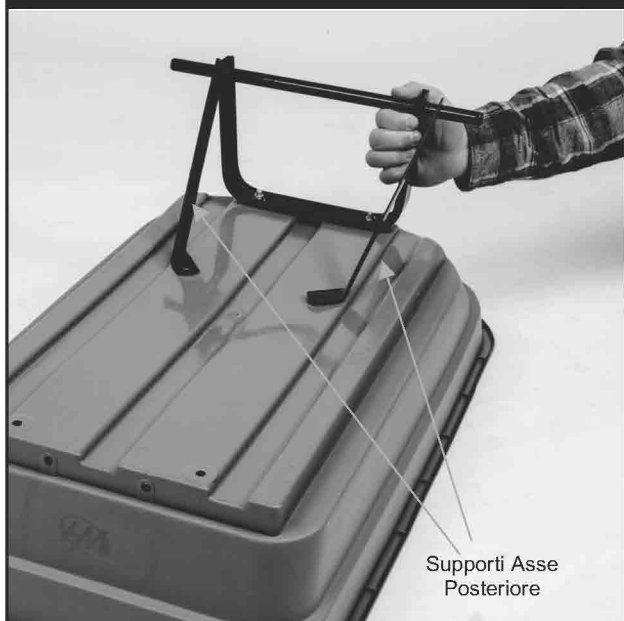

9

Riprendere l'asse anteriore assemblato precedentemente e fissarlo alle staffe di supporto utilizzando i bulloni e le rondelle in dotazione

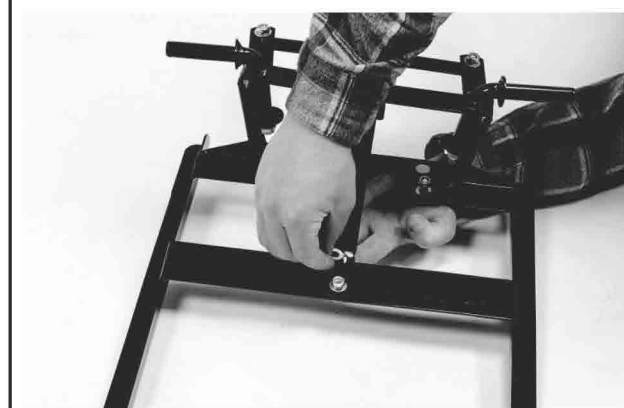
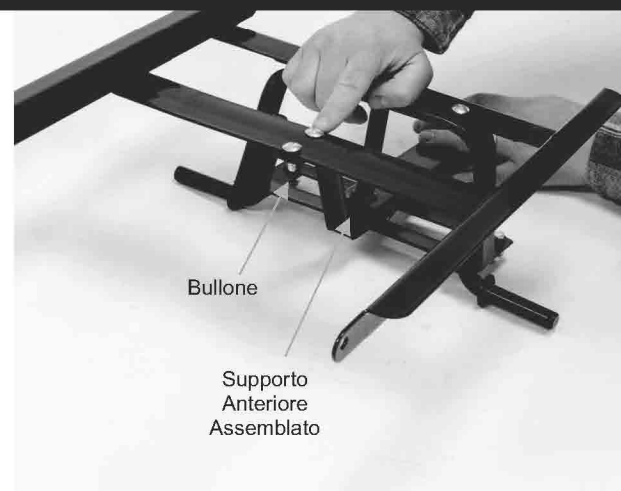
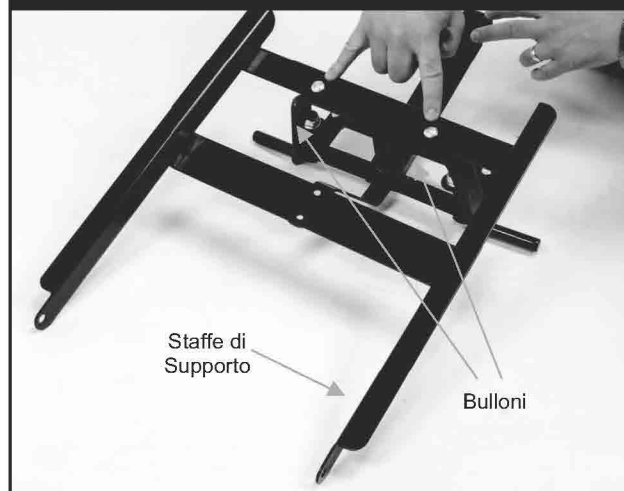

10

Stringere bene tutti i bulloni per fissare l'asse anteriore ad ogni componente dell'assemblato

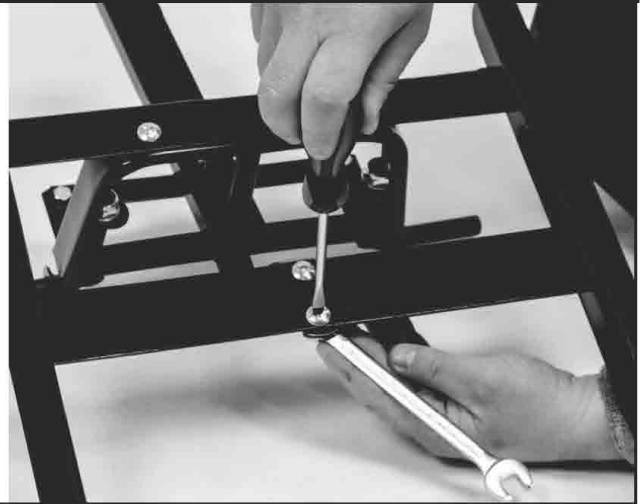
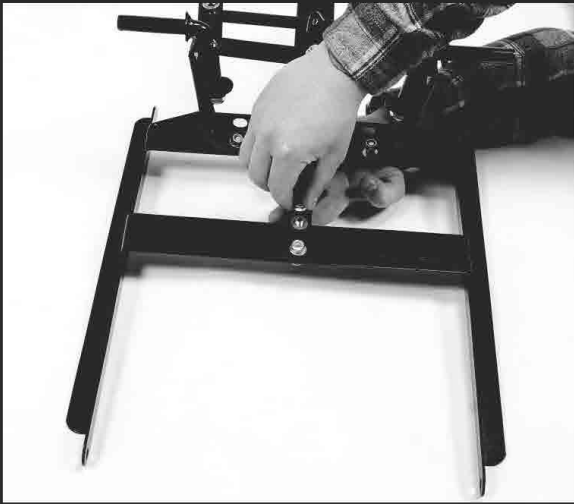

11

Utilizzando i bulloni in dotazione installare il gancio di ribaltamento frontale

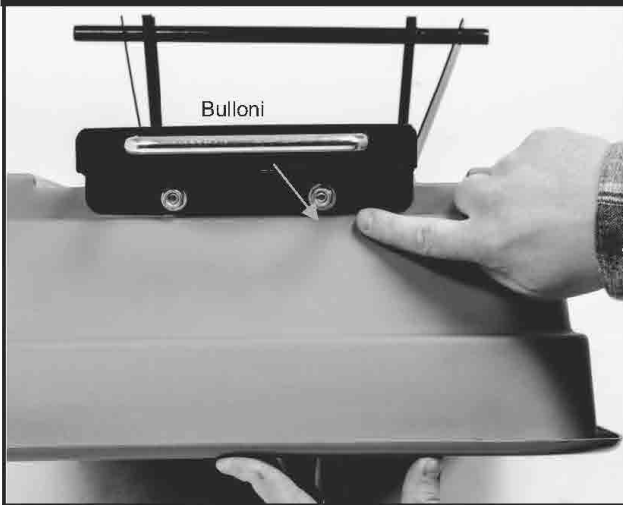

12 Controllare che tutte le viti e bulloni dell'asse inferiore siano ben stretti prima di procedere con i passi successivi.



13 Allineare le staffe di supporto assemblate precedentemente con i relativi binari nel carrello e fissarle con le relative rondelle e bulloni.

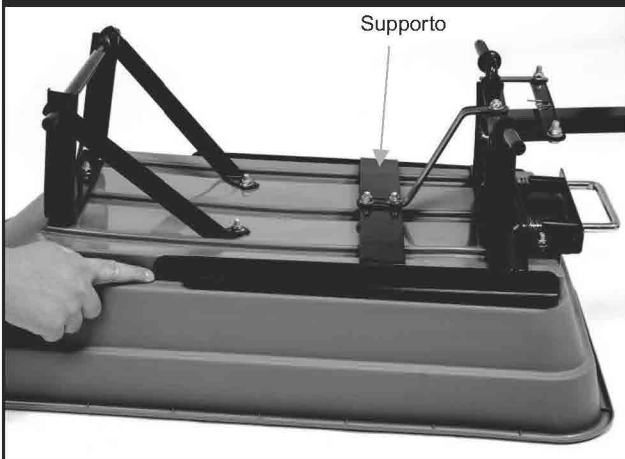

14 Coricare l'assemblato su uno dei due lati ed installare le 4 ruote utilizzando le apposite rondelle ed i perni di sicurezza delle ruote. Utilizzare una pinza per piegare bene i perni e garantire il fissaggio.

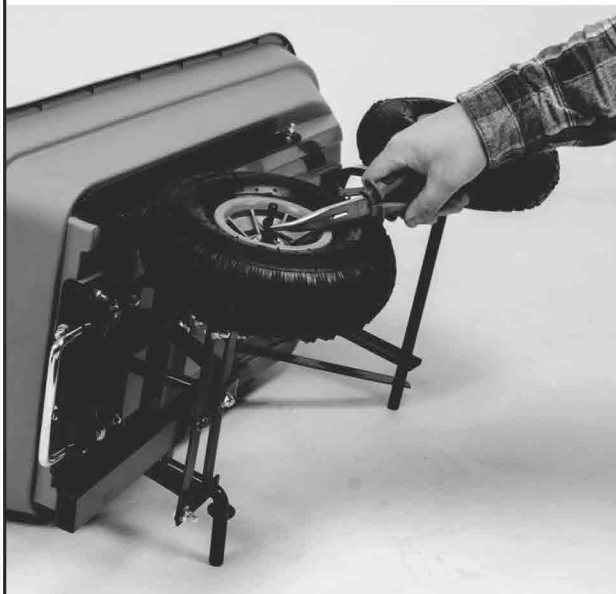
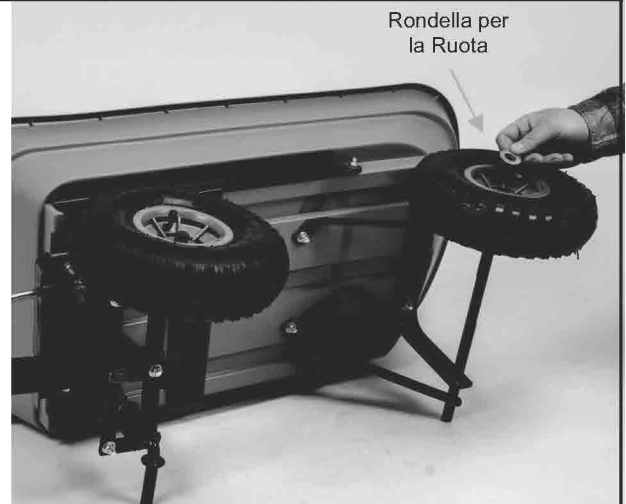
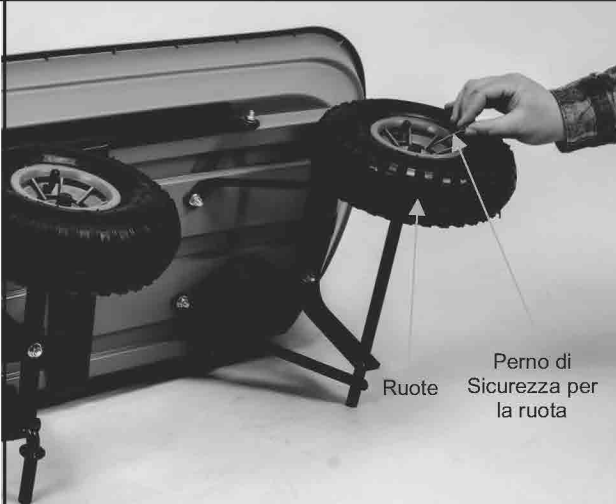

15 Installare il connettore manico/asse e successivamente agganciare il manico allo stesso utilizzando il bullone di fissaggio. Stringere bene tutte le viti prima di procedere all' utilizzo.

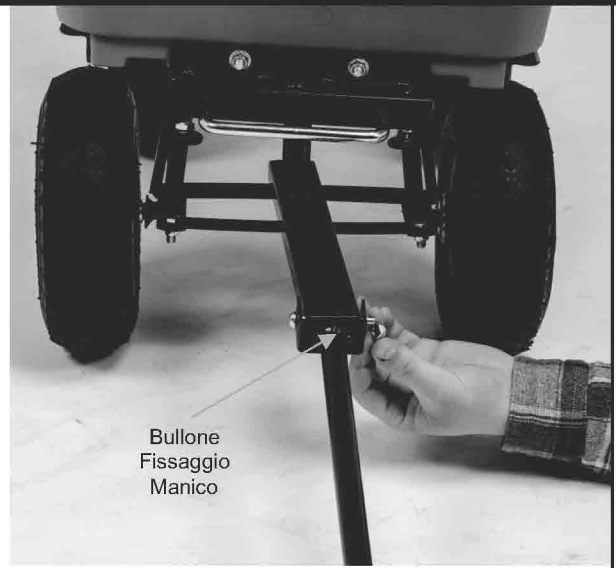
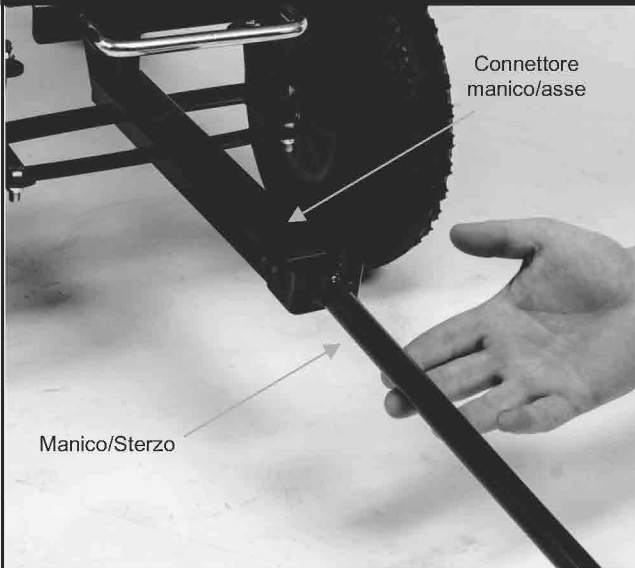

BOUDECH

GARDEN TROLLEY WITH TIPPER TRAILER
MDL TC1255 250KG



ENGLISH MANUAL





- 1** Insert the steering stabilizer into the cylindrical protuberance of the front axle connector.



- 2** Install the previously assembled connector on the front axle.

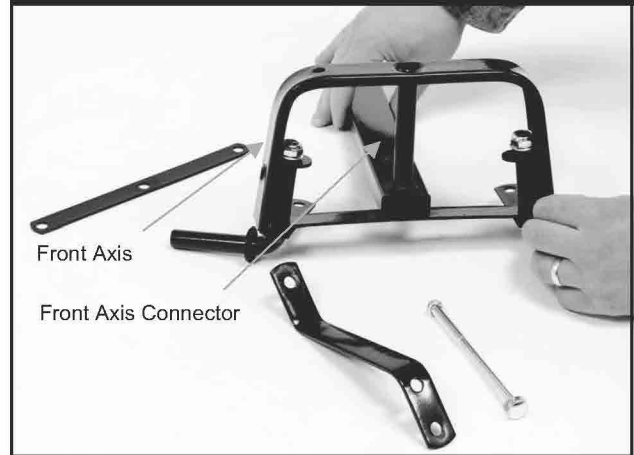

- 3** Position the front axle support on the underside of the axle transverse lever at the cylindrical protuberance and secure it using the steering bolt and the respective pair of washer and bolt supplied.

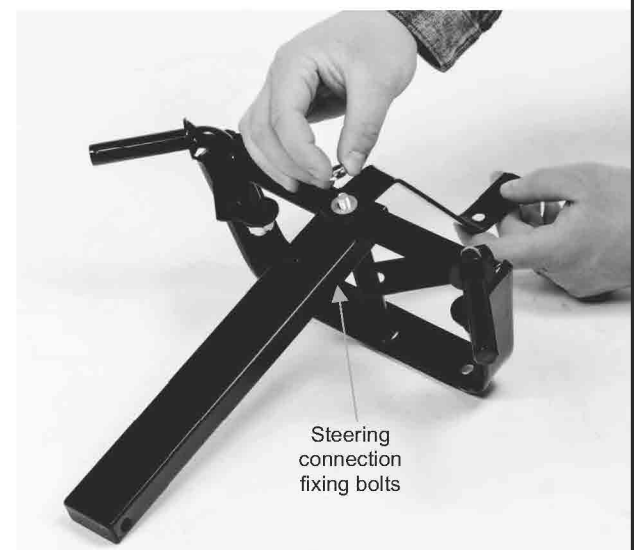
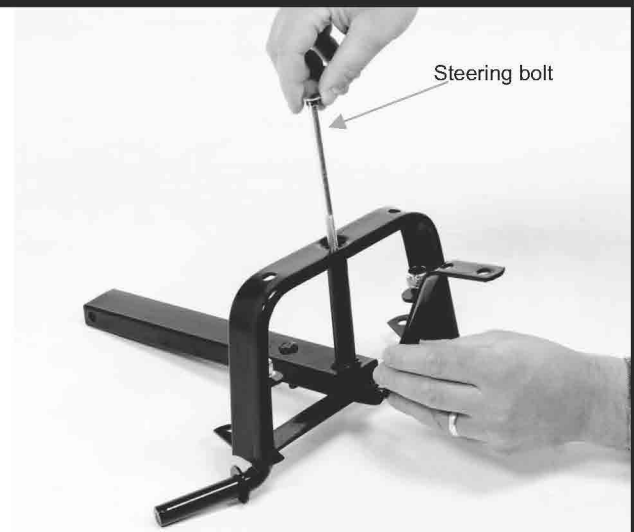

- 4** Position the two holes in the steering connector in line with the two holes on the axle angles and secure it using the washers and bolts supplied.

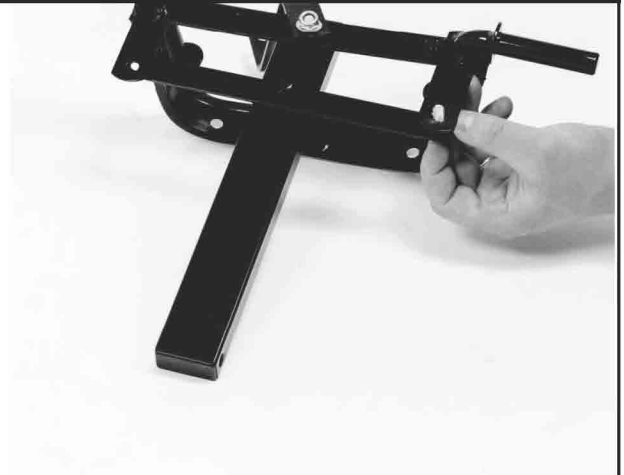
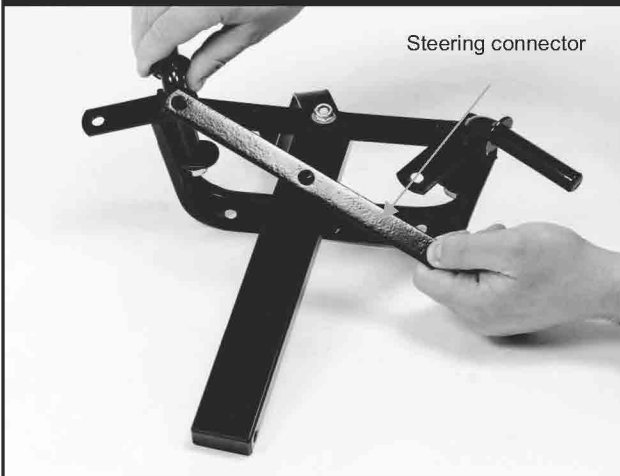

- 5** Place the safety pin between the axle connector and the steering connector.



- 6** Open up the ends of the safety pin and secure it.



7

Position the rear axle on the trailer and secure it using the bolts provided.

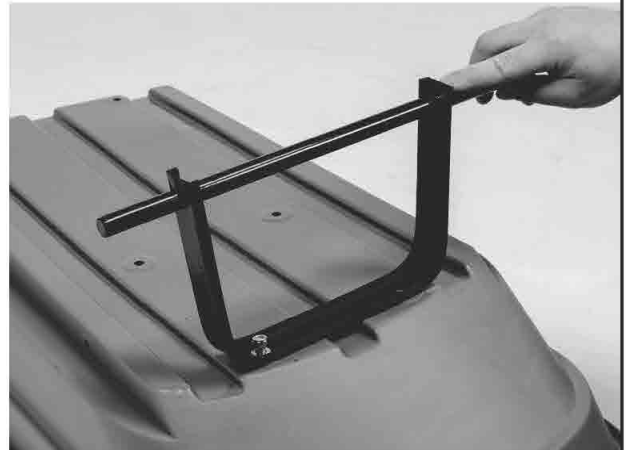
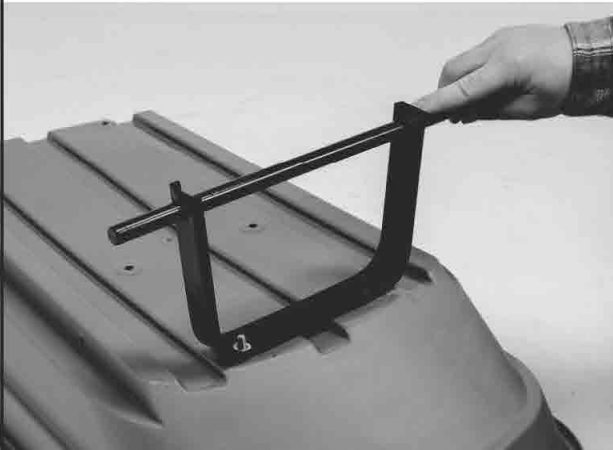
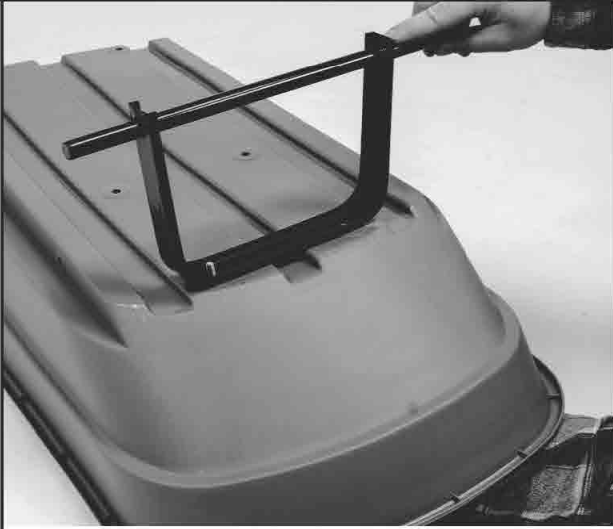

8

Install the supports to the rear axle using the bolts and washers provided.

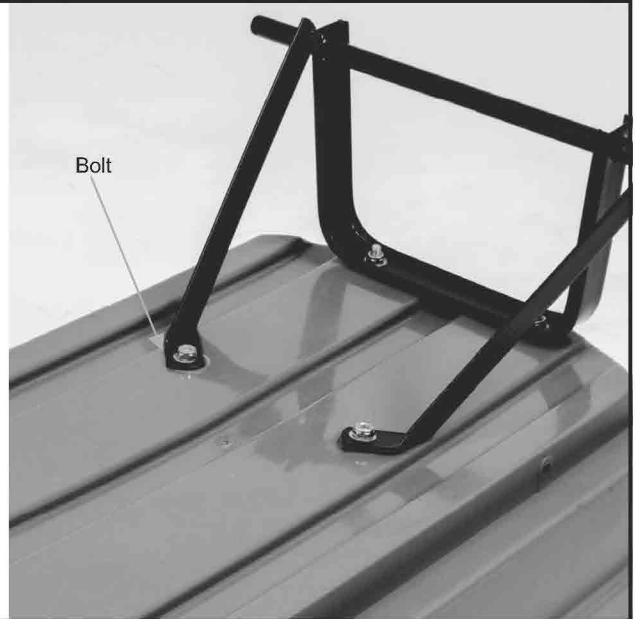

9

Take the previously assembled front axle and fasten it to the support brackets using the bolts and washers provided.

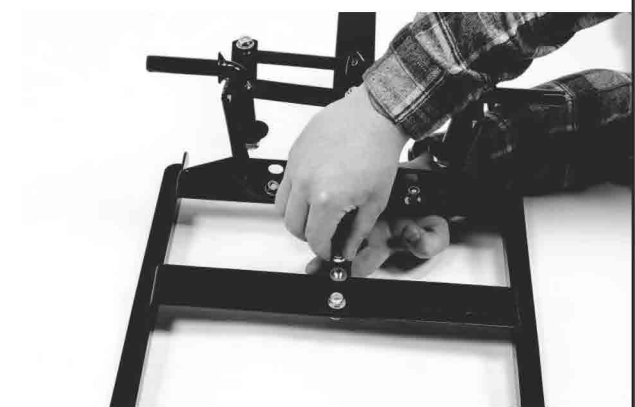
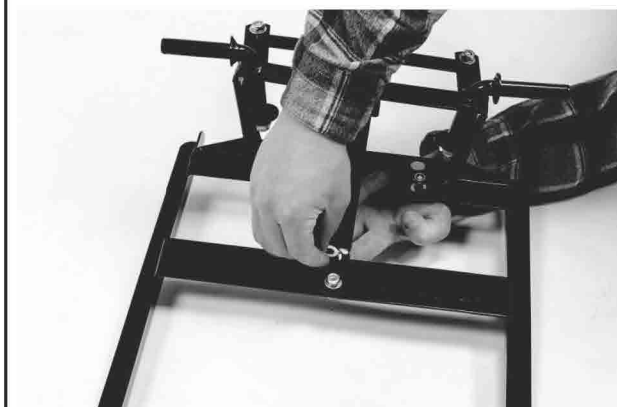
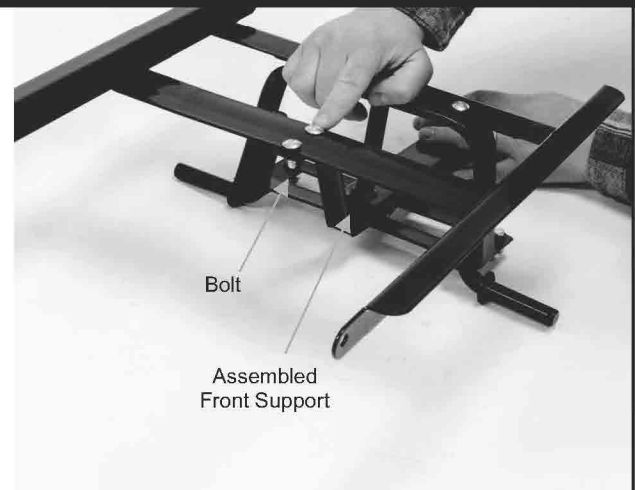
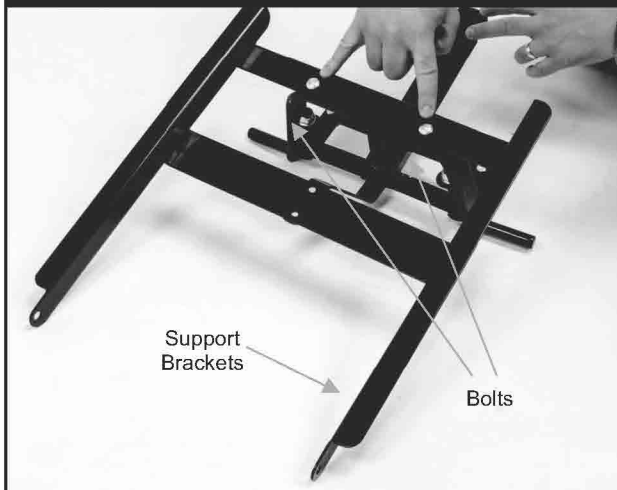

10 Tighten all bolts to secure the front axle to each component of the assembly.

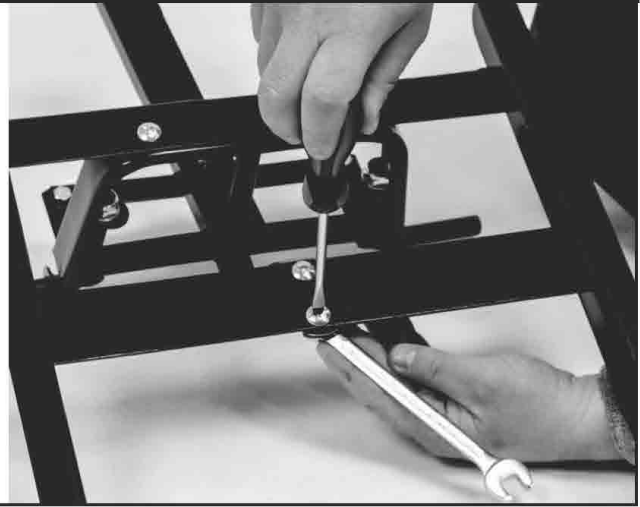
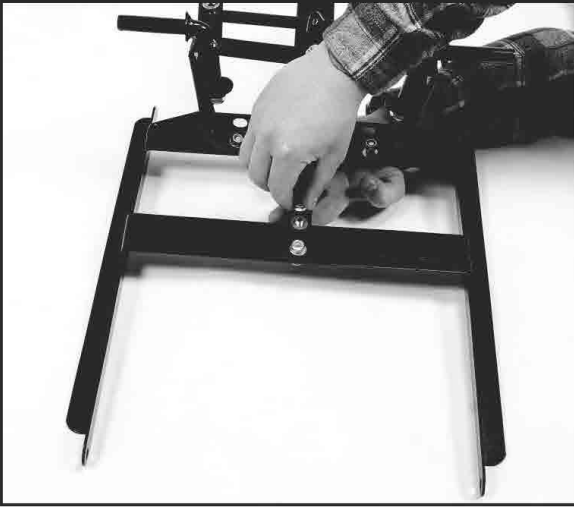

11 Using the supplied bolts install the front tilting hook

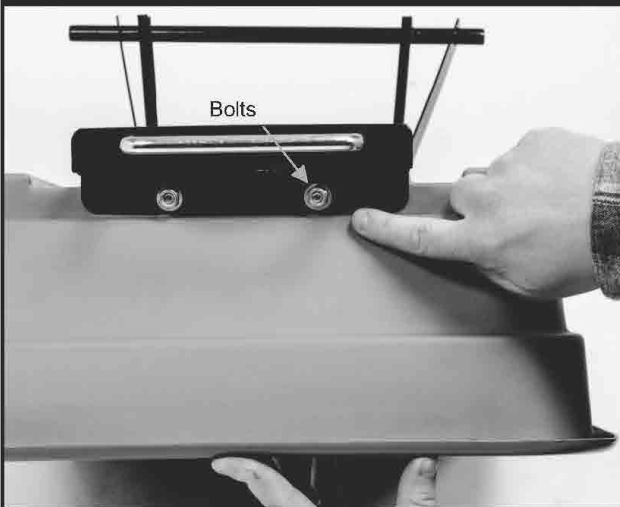

12 Check that all screws and bolts on the lower axle are tight before proceeding with the next steps.



13 Align the previously assembled support brackets with the corresponding rails in the carriage and secure them with the corresponding washers and bolts.

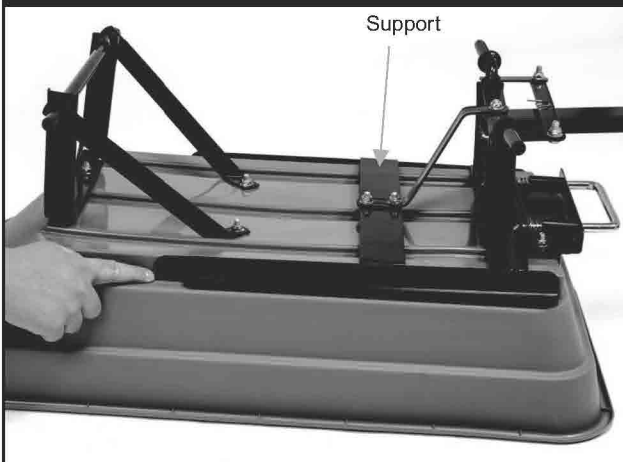

14 Lay the assembled unit on one of the two sides and install the 4 wheels using the appropriate washers and wheel safety pins. Use a clamp to bend the pins well and secure them.

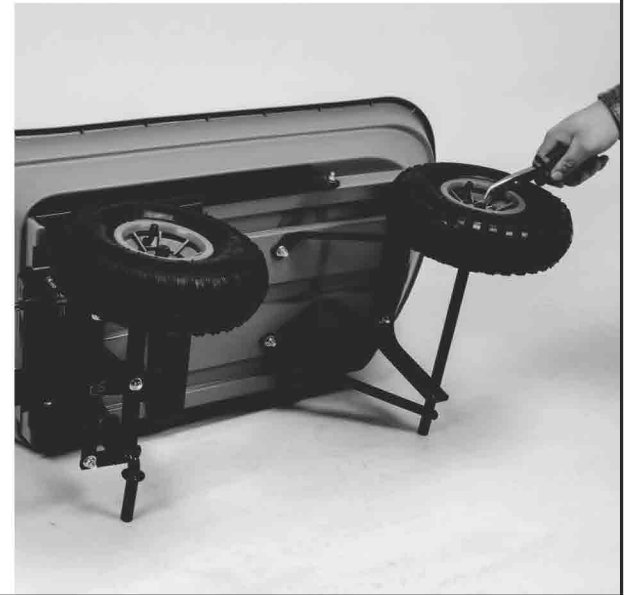
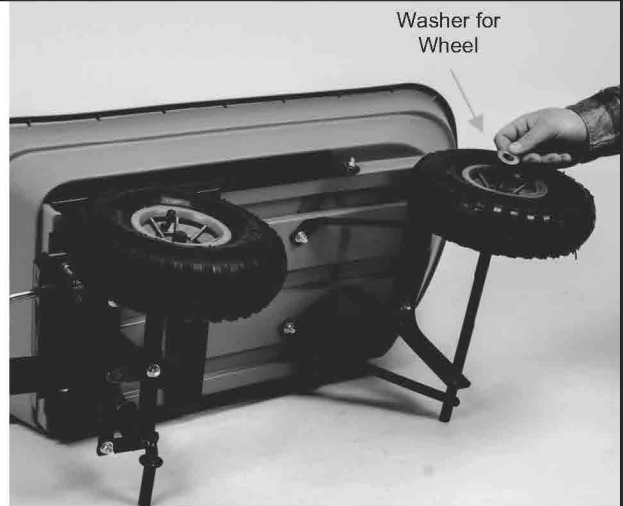

15 Install the handle/axis connector and then attach the handle to it using the fixing bolt. Tighten all screws well before use.

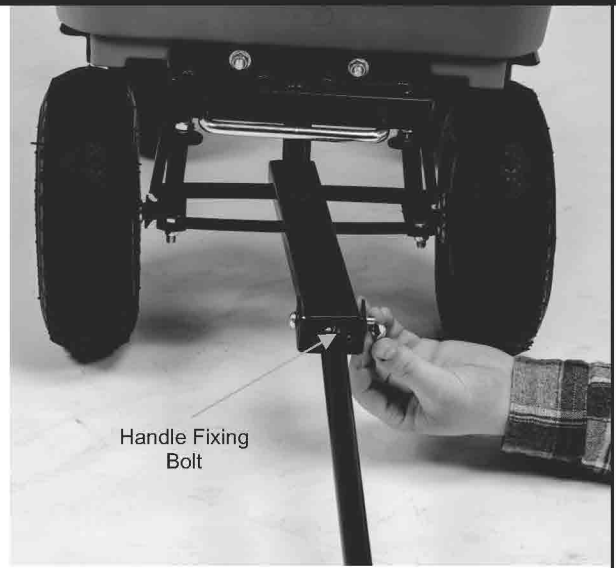
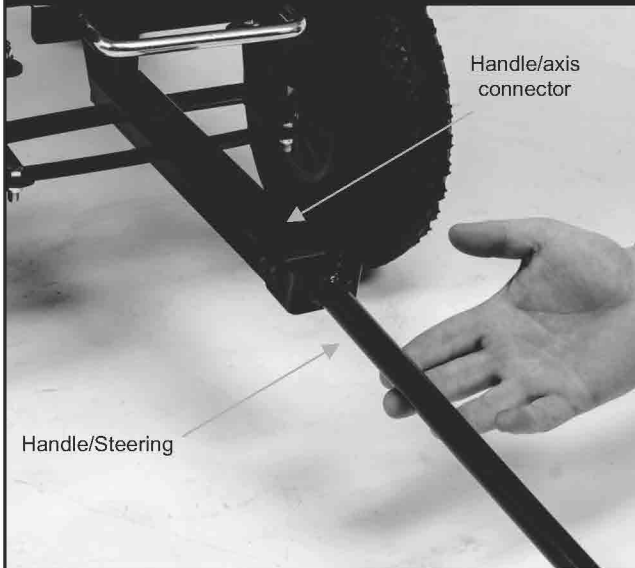

BOUDECH

CHARIOT DE JARDIN AVEC REMORQUE À BENNE BASCULANTE
MDL TC1255 250KG

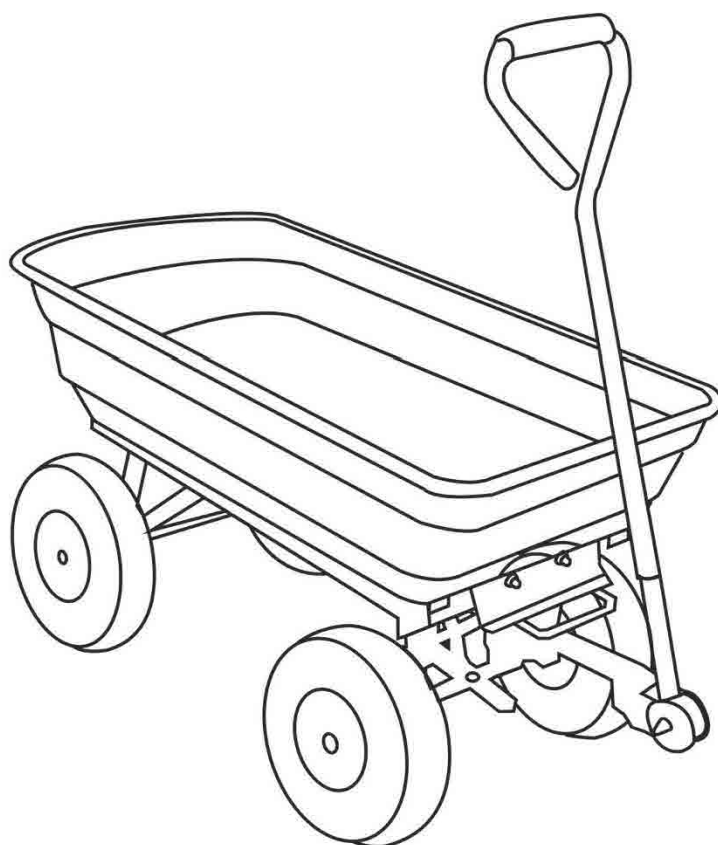

FRENCH MANUAL



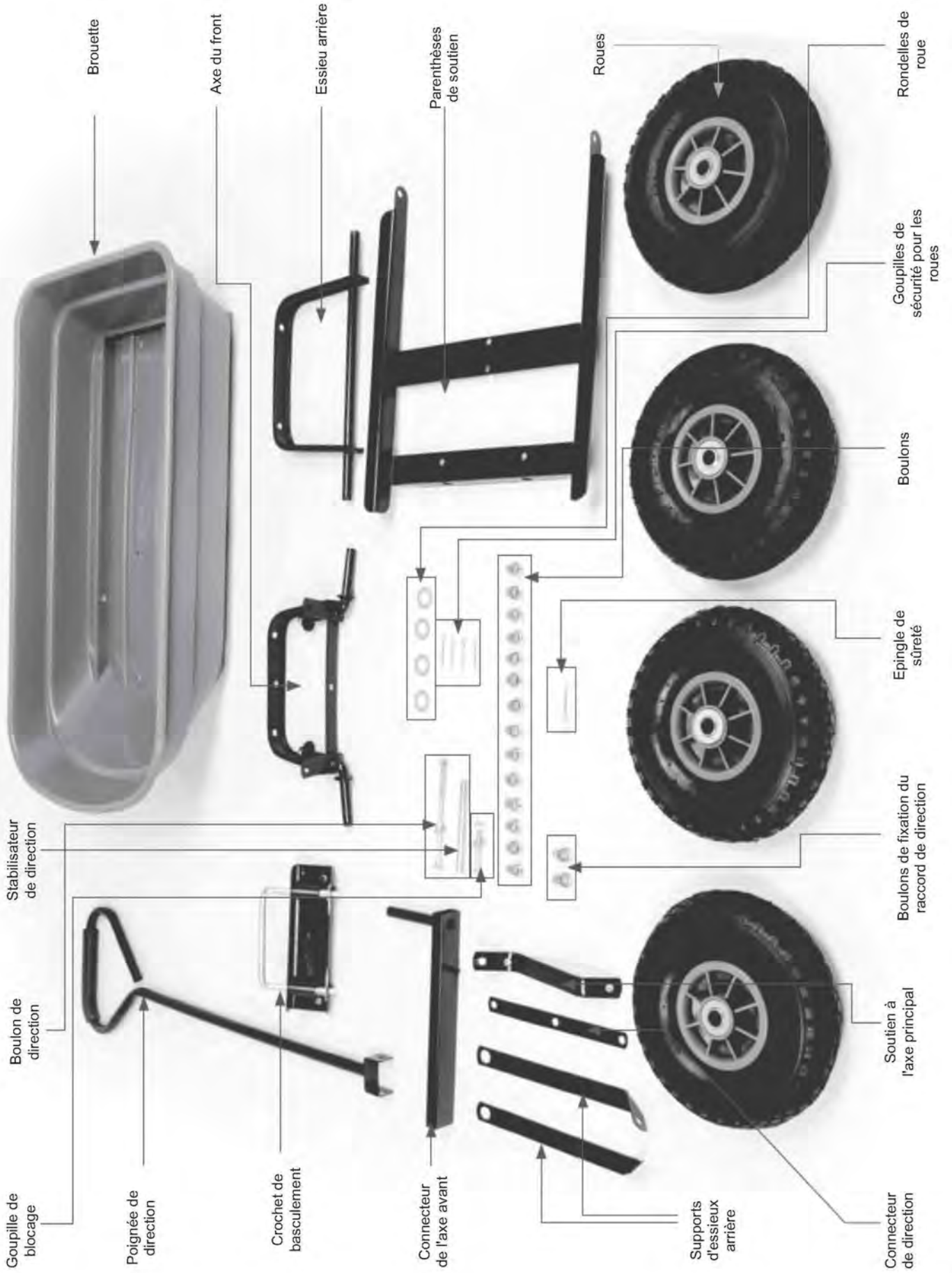

- 1** Insérez le stabilisateur de direction dans la protubérance cylindrique du connecteur de l'essieu avant.

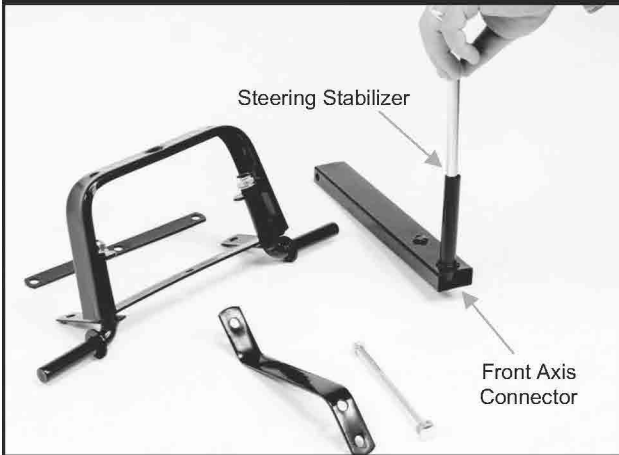

- 2** Installez le connecteur préalablement assemblé sur l'essieu avant.

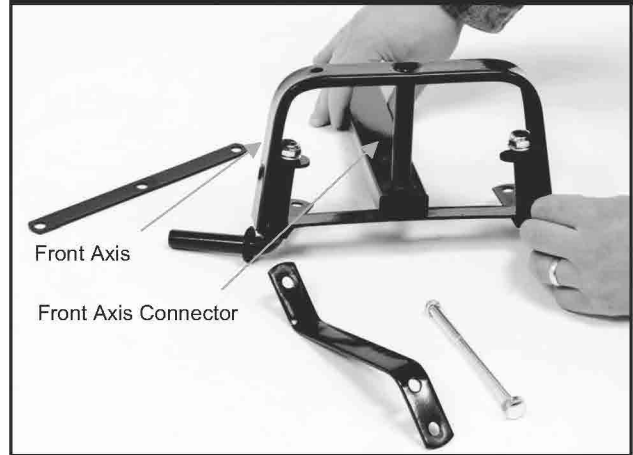

- 3** Positionner le support de l'essieu avant sur la face inférieure du levier transversal de l'essieu au niveau de la protubérance cylindrique et le fixer à l'aide du boulon de direction et de la paire respective de rondelle et de boulon fournis.

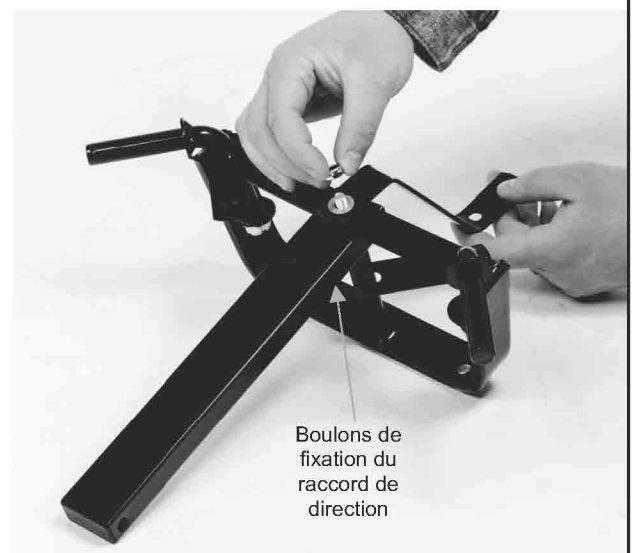
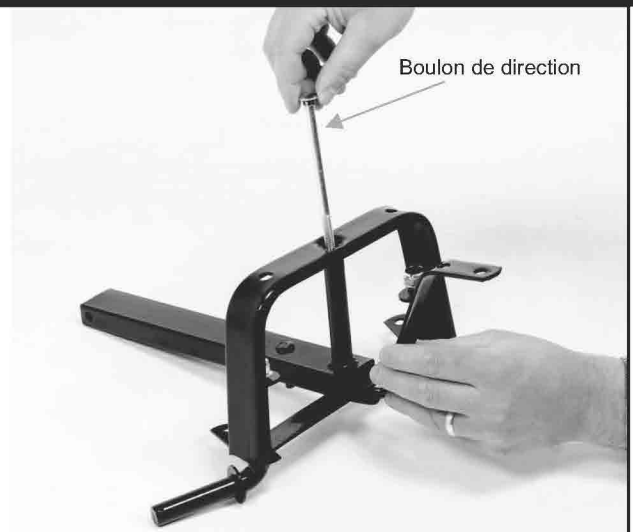
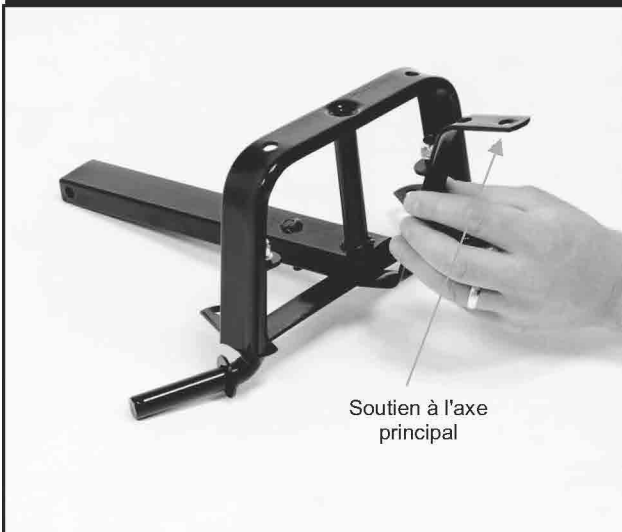

- 4** Positionnez les deux trous du connecteur de direction dans l'alignement des deux trous sur les angles d'essieu et fixez-le à l'aide des rondelles et des boulons fournis.

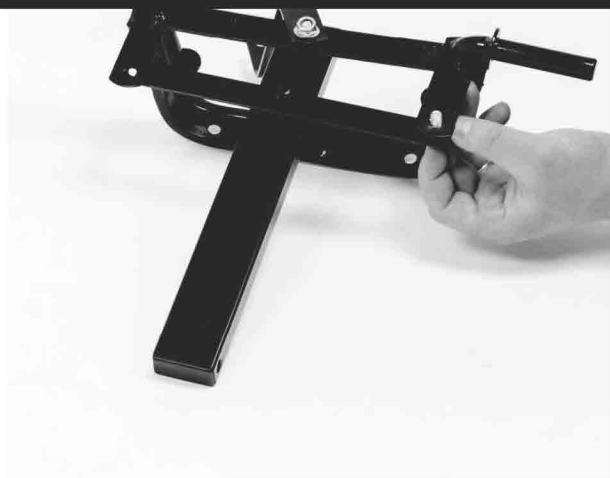
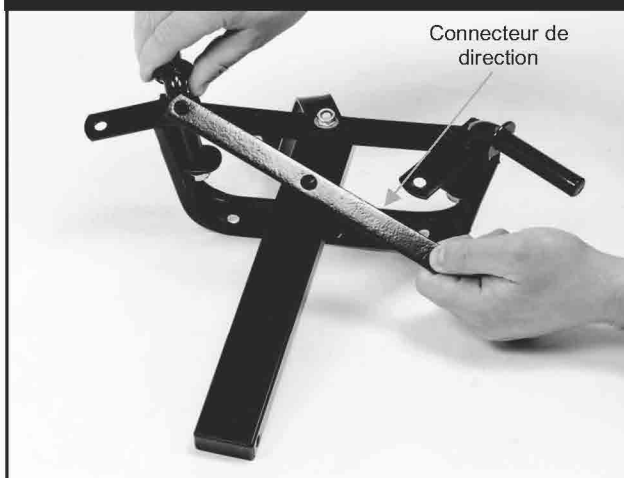

- 5** Placez la goupille de sécurité entre le connecteur d'essieu et le connecteur de direction.



- 6** Ouvrez les extrémités de l'épingle de sûreté et sécurisez-la.



7

Positionnez l'essieu arrière sur la remorque et fixez-le à l'aide des boulons prévus à cet effet.

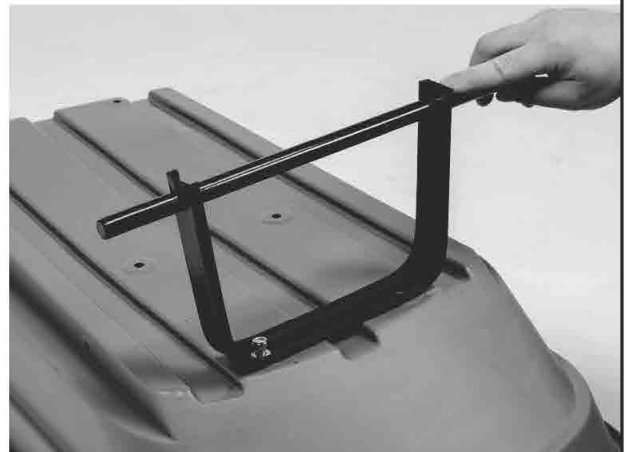
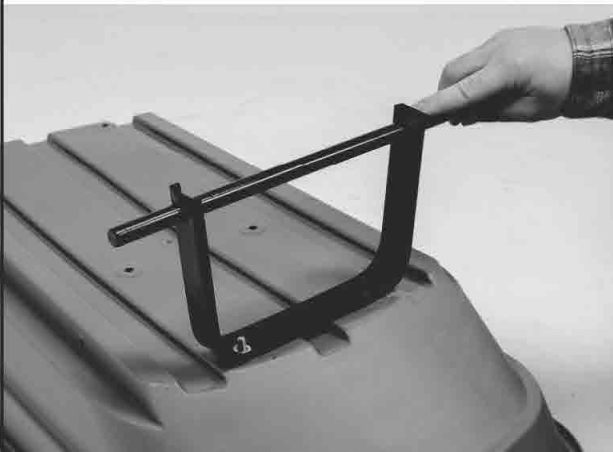
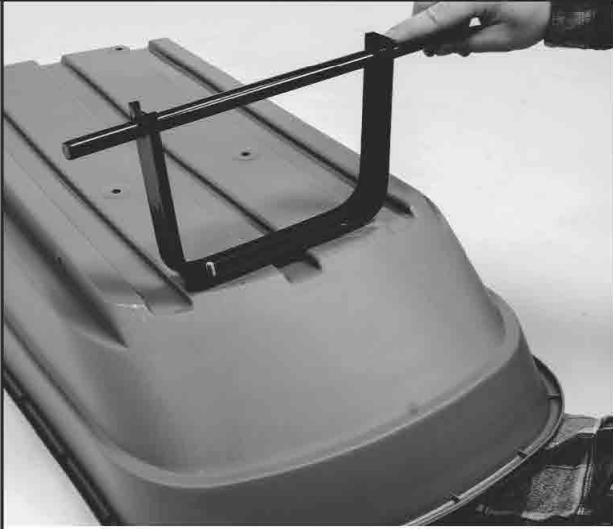

8

Installez les supports sur l'essieu arrière à l'aide des boulons et des rondelles fournis.

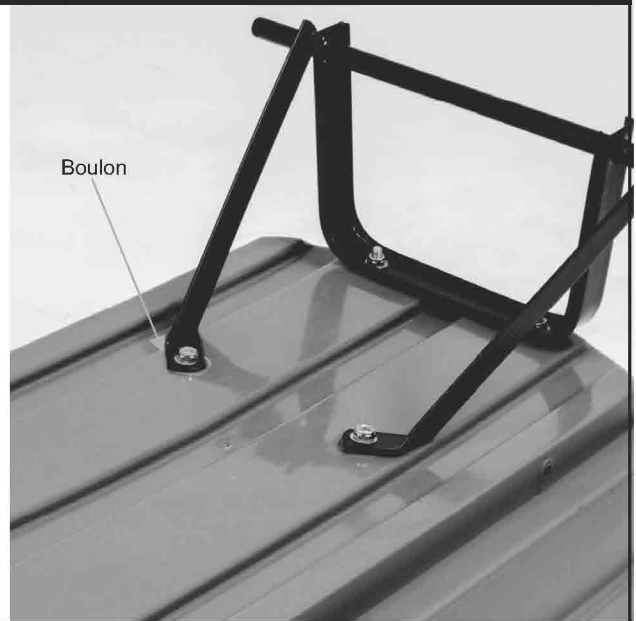
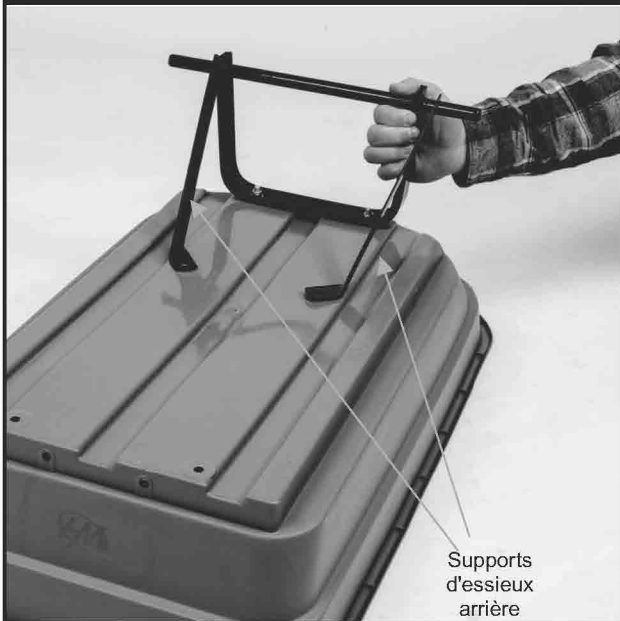

9

Prenez l'essieu avant préalablement assemblé et fixez-le aux supports à l'aide des boulons et des rondelles fournis.

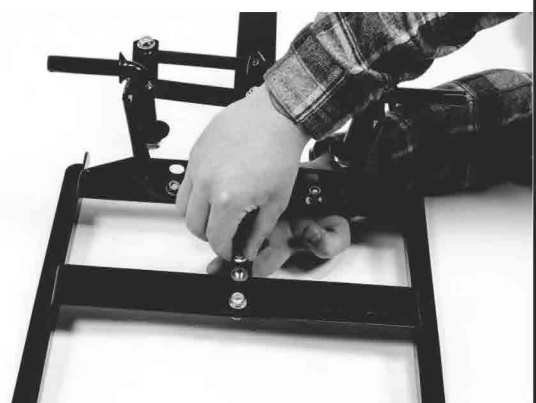
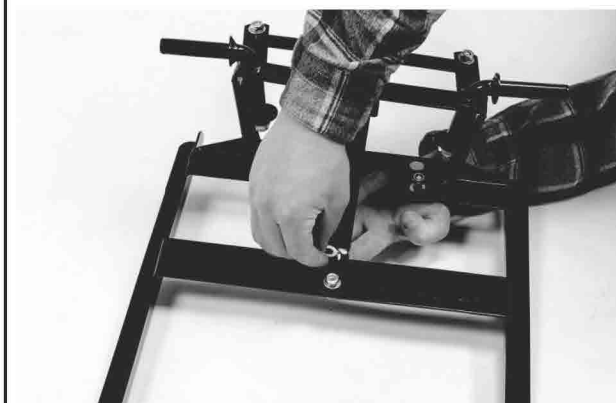
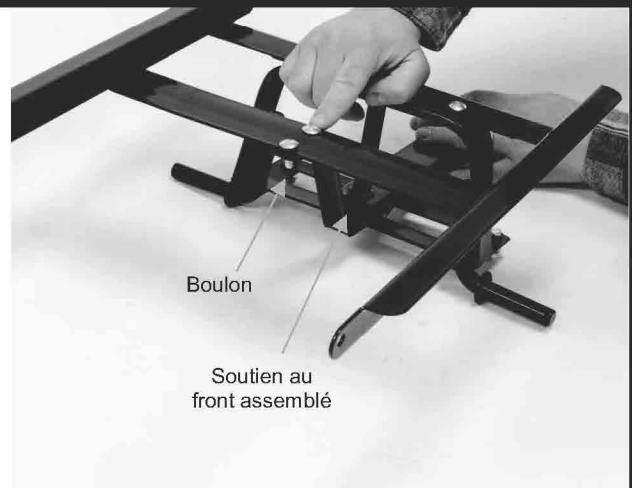
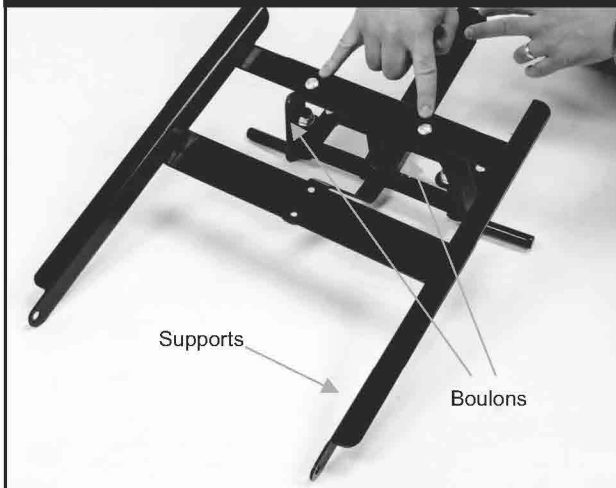

10 Serrez tous les boulons pour fixer l'essieu avant à chaque élément de l'ensemble.

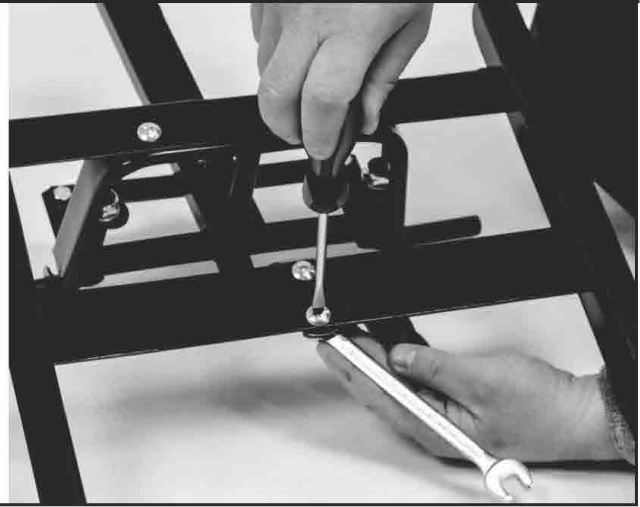
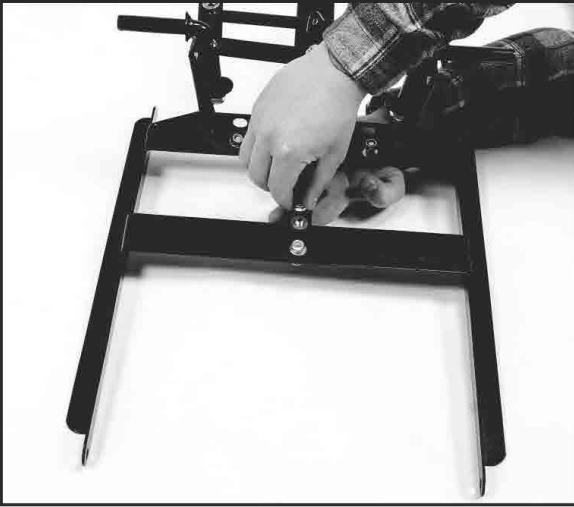

11 À l'aide des boulons fournis, installez le crochet basculant avant

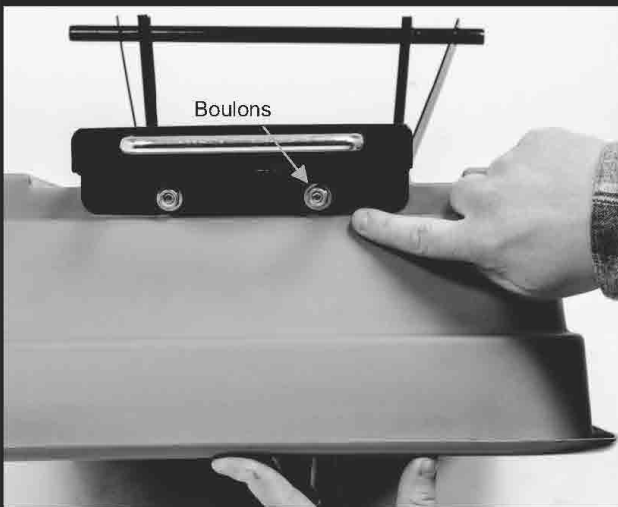

12 Vérifiez que toutes les vis et tous les boulons de l'essieu inférieur sont bien serrés avant de passer aux étapes suivantes.



13 Alignez les supports préalablement assemblés avec les rails correspondants du wagon et fixez-les avec les rondelles et les boulons correspondants.

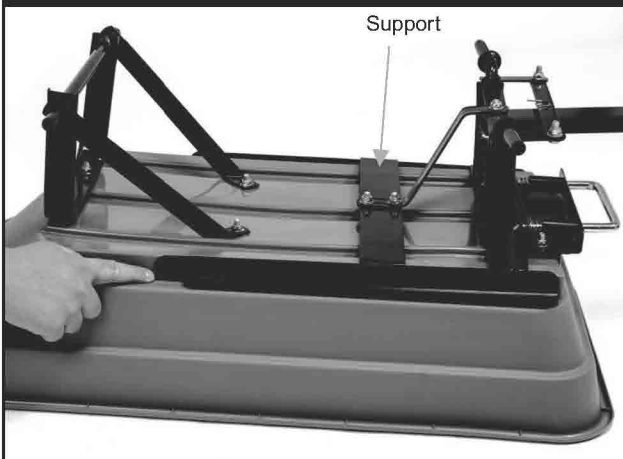

14 Posez l'unité assemblée sur l'un des deux côtés et installez les 4 roues en utilisant les rondelles et les goupilles de sécurité de roue appropriées. Utilisez une pince pour bien plier les épingles et les fixer.

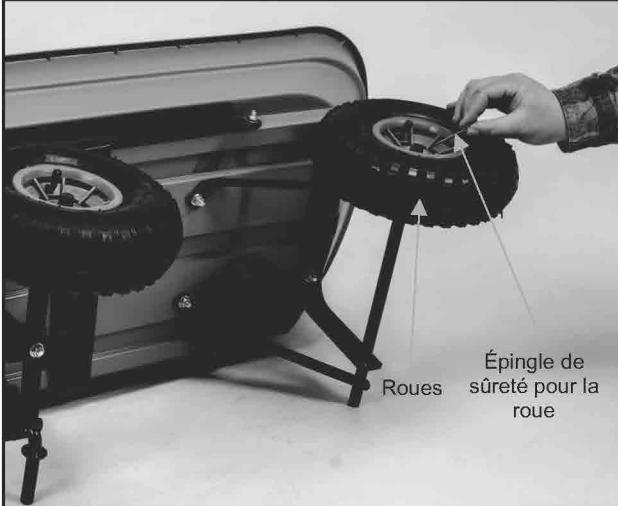

15 Installez le connecteur poignée/axe, puis fixez la poignée à l'aide du boulon de fixation. Serrez bien toutes les vis avant l'utilisation.

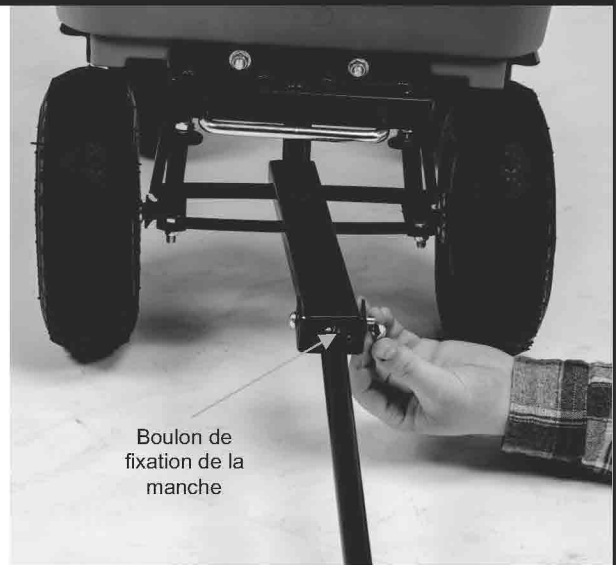
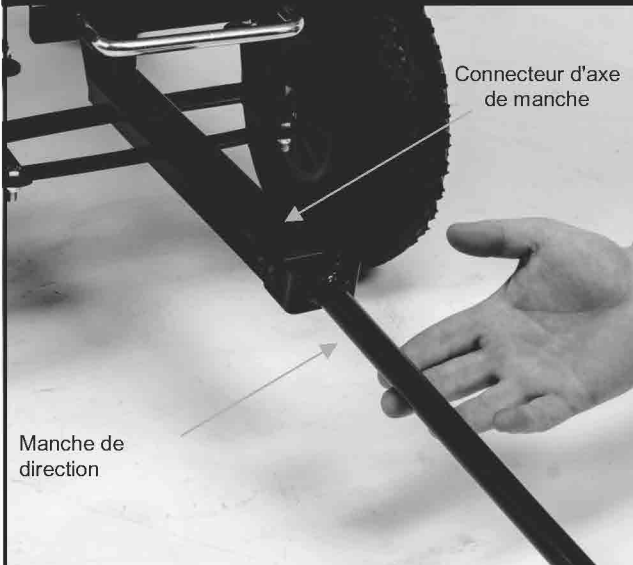

BOUDECH

CARRO DE JARDÍN CON REMOLQUE DE VOLQUETE
MDL TC1255 250KG

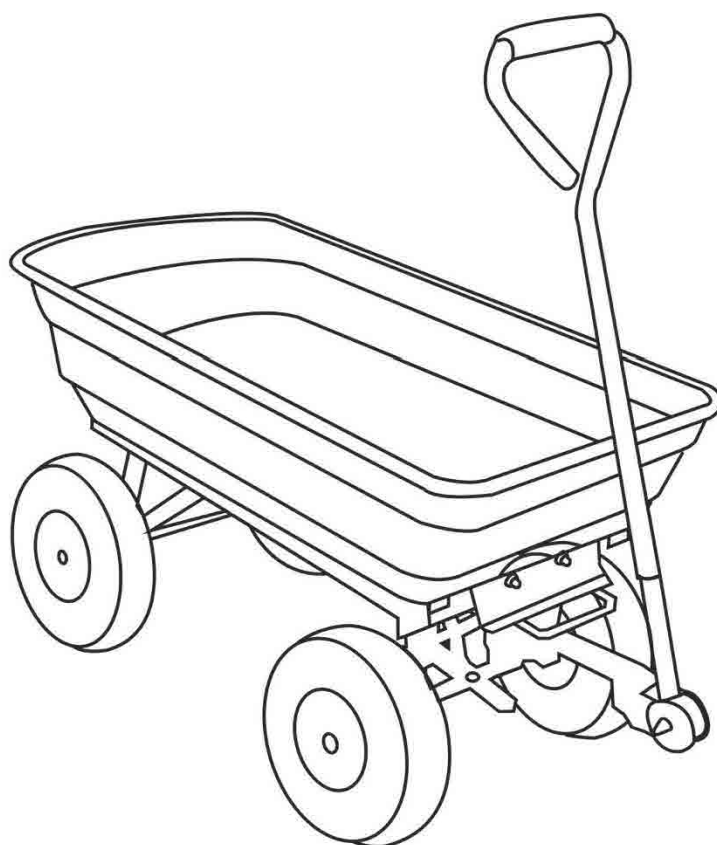

SPANISH MANUAL



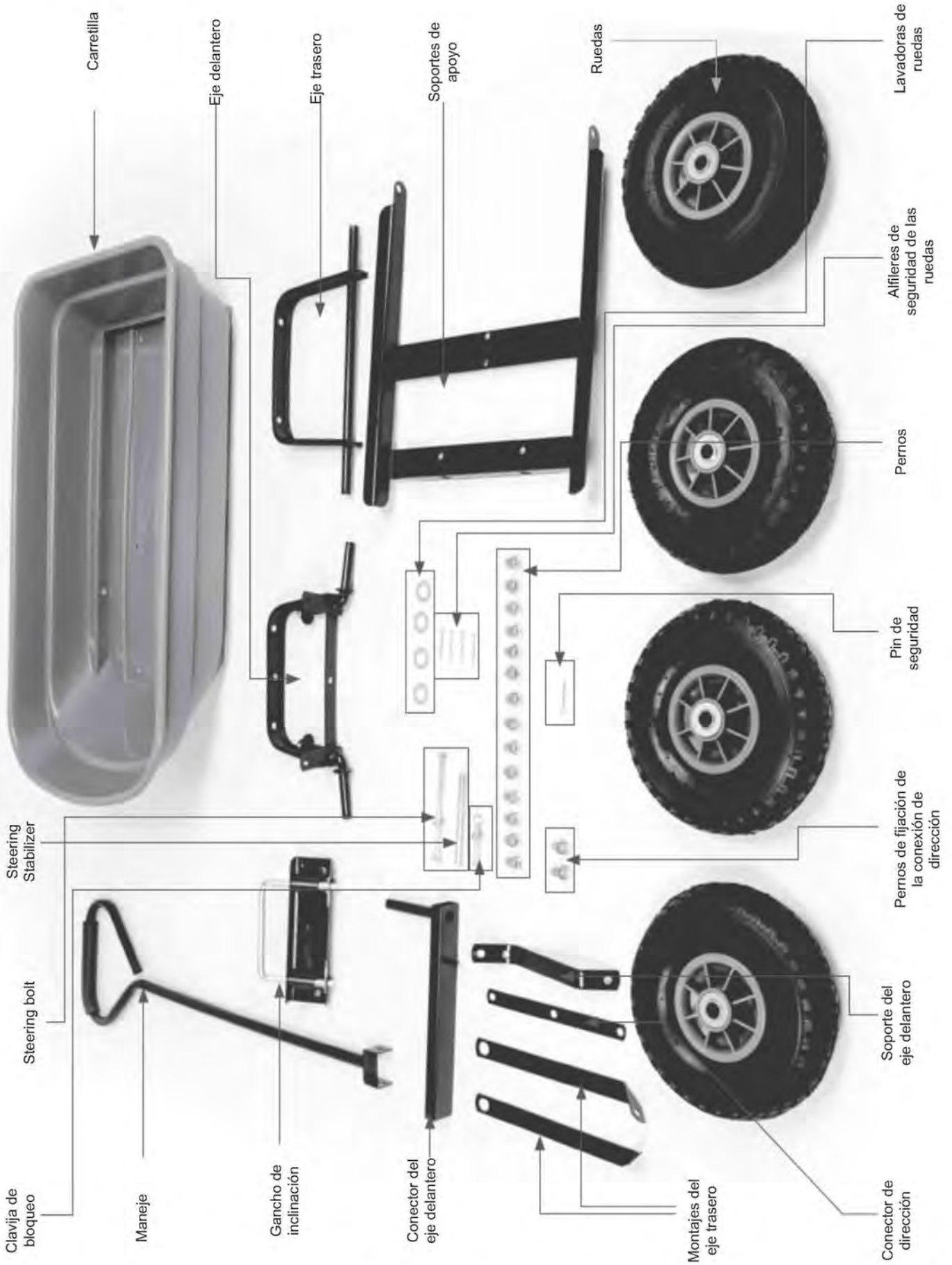

- 1** Inserte el estabilizador de dirección en la protuberancia cilíndrica del conector del eje delantero.



- 2** Instale el conector previamente ensamblado en el eje delantero.



- 3** Coloque el soporte del eje delantero en la parte inferior de la palanca transversal del eje en la protuberancia cilíndrica y fíjelo con el perno de dirección y el respectivo par de arandelas y pernos suministrados.

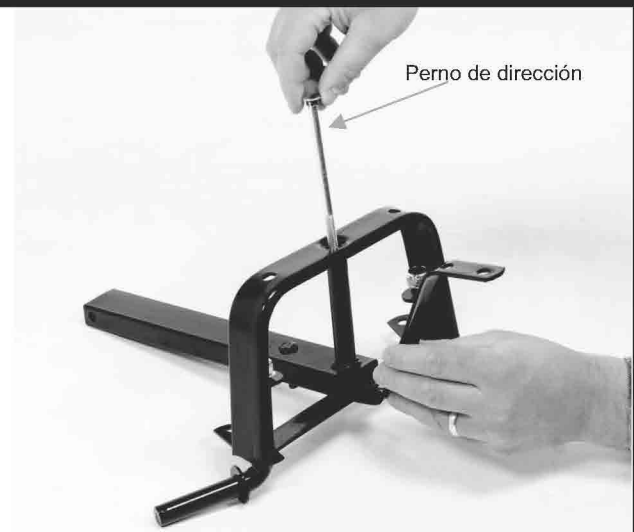

- 4** Coloca los dos agujeros del conector de dirección en línea con los dos agujeros de los ángulos del eje y fíjalo con las arandelas y los pernos suministrados.

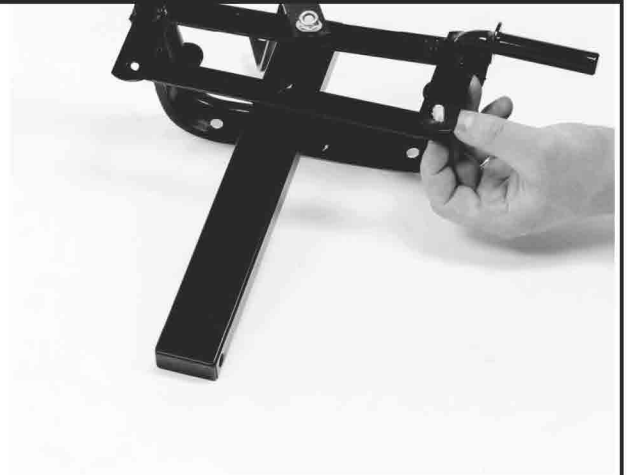
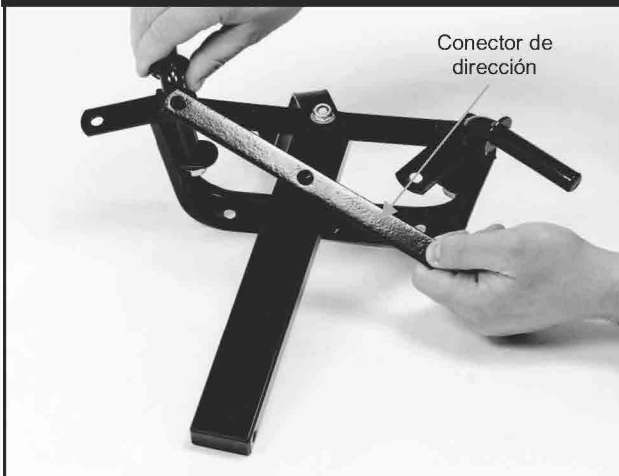

- 5** Coloca el pasador de seguridad entre el conector del eje y el conector de la dirección.



- 6** Abre los extremos del imperdible y asegúralo.



7

Coloque el eje trasero en el remolque y asegúrelo con los pernos suministrados.

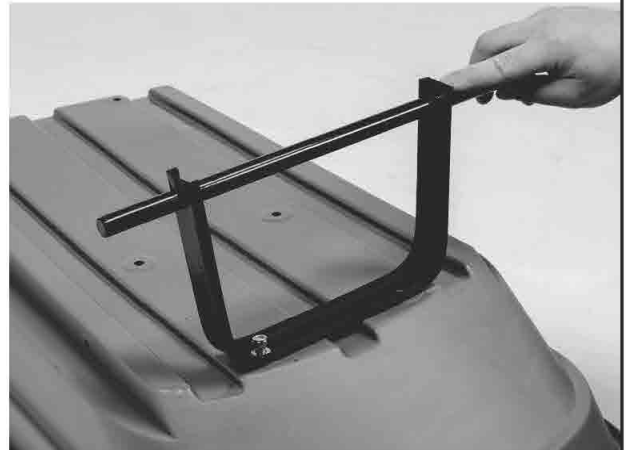
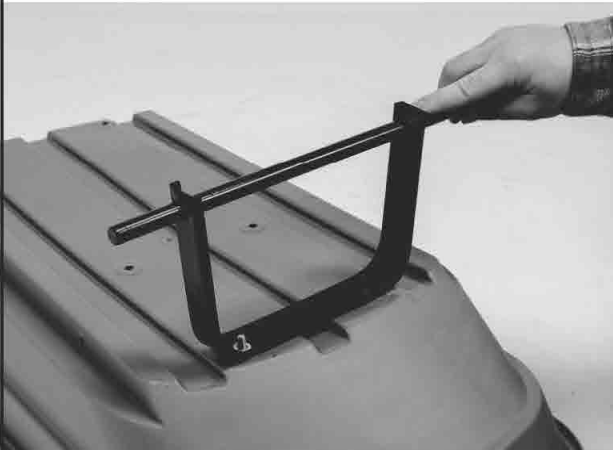
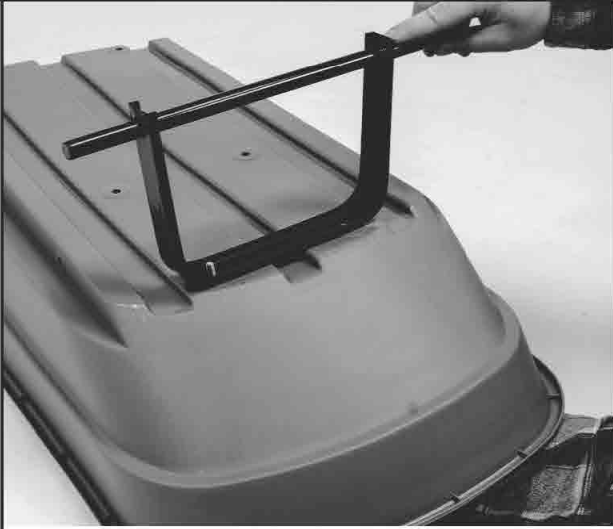

8 Instale los soportes en el eje trasero usando los pernos y arandelas provistos.

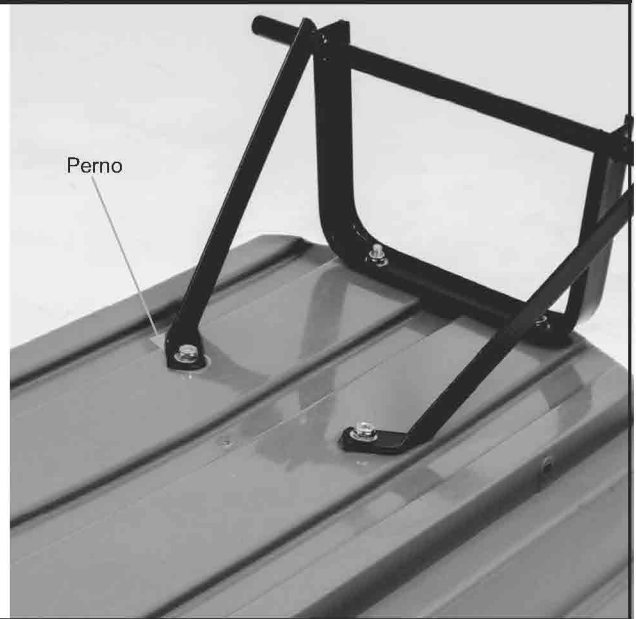

9 Tome el eje delantero previamente ensamblado y sujételo a los soportes de apoyo con los pernos y arandelas suministrados.

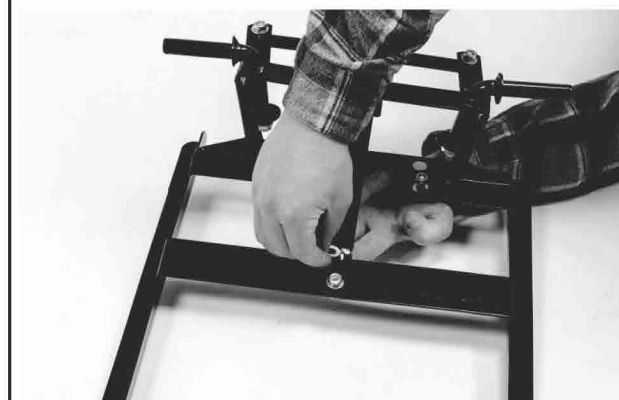
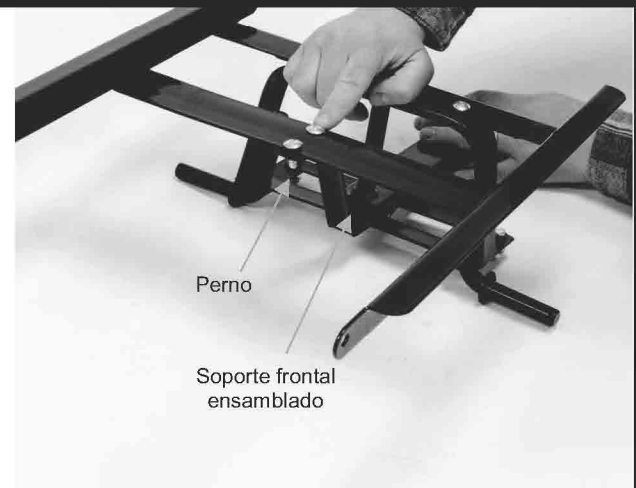
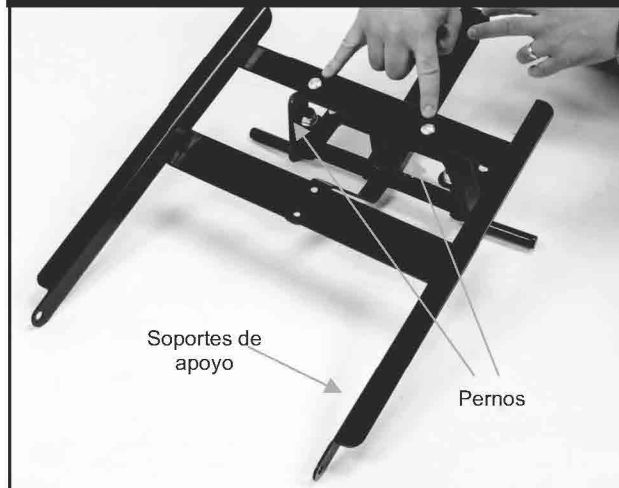

10

Apriete todos los pernos para asegurar el eje delantero a cada componente del conjunto.

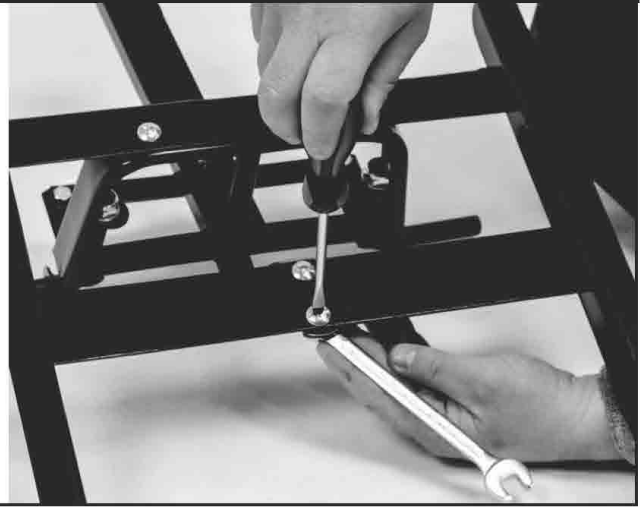
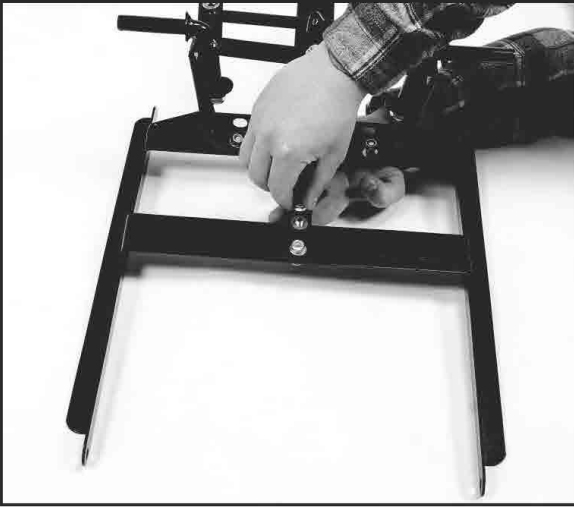

11

Usando los pernos suministrados instale el gancho basculante delantero

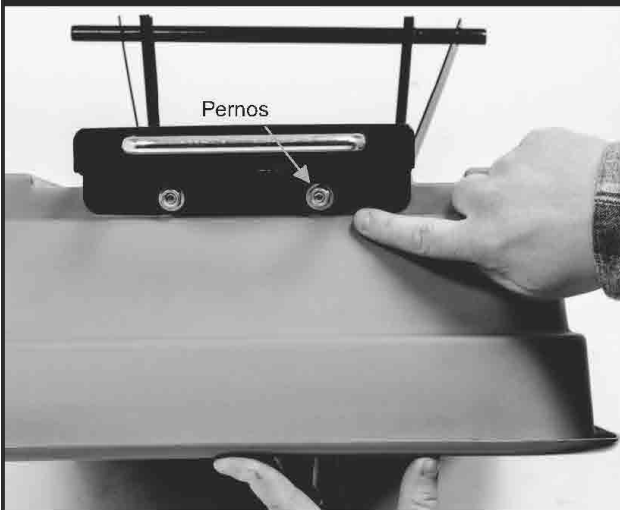

12 Compruebe que todos los tornillos y pernos del eje inferior estén apretados antes de continuar con los siguientes pasos.



13 Alinee los soportes de apoyo previamente ensamblados con los rieles correspondientes en el carro y asegúrelos con las arandelas y pernos correspondientes.

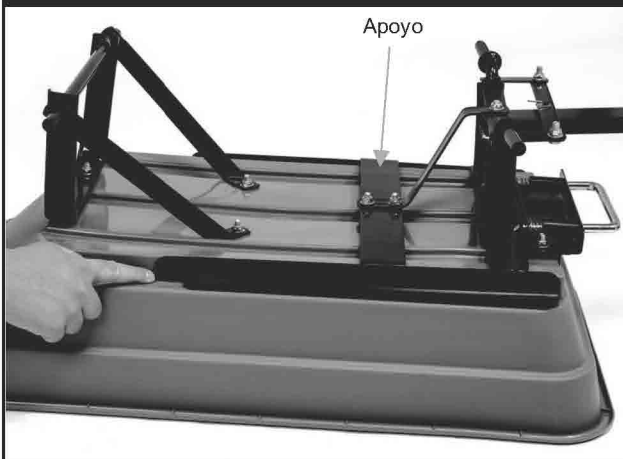

14 Coloca la unidad ensamblada en uno de los dos lados e instala las 4 ruedas usando las arandelas y los pasadores de seguridad de la rueda apropiados. Use una abrazadera para doblar bien los pasadores y asegurarlos.



15

Instale el conector del mango/eje y luego fije el mango a él con el perno de fijación. Apriete bien todos los tornillos antes de usarlos.

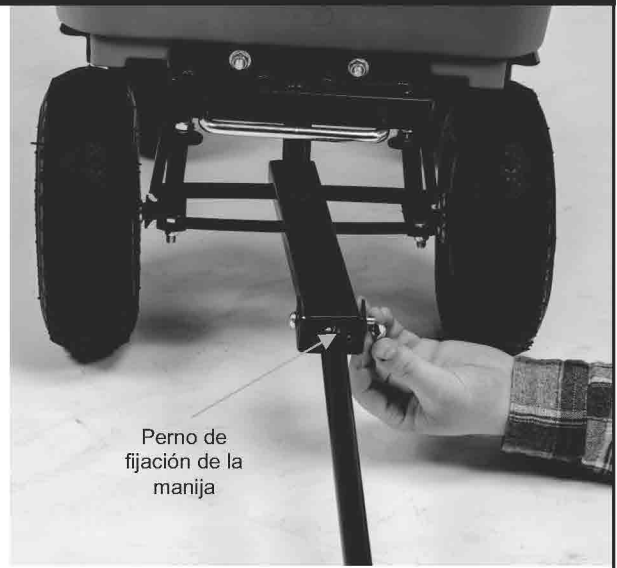
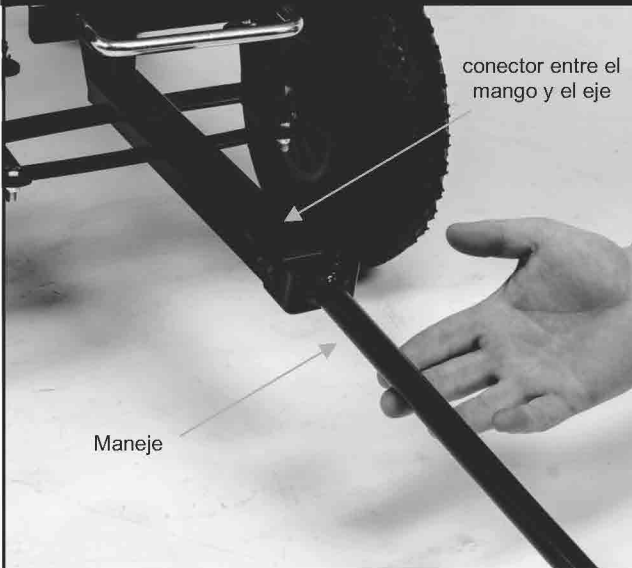

BOUDECH
EMPOWERING EQUIPMENTS