

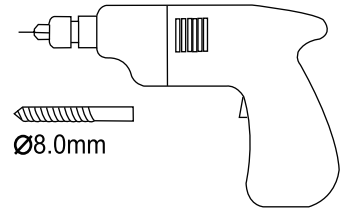

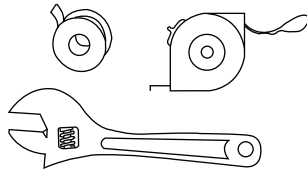

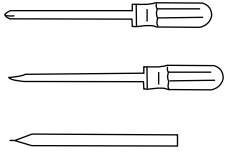

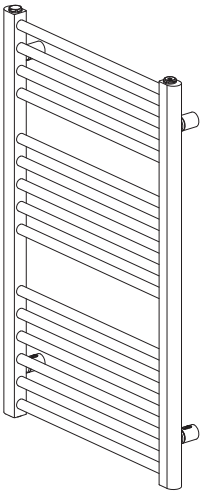



Towel Rail Installation

- review instructions carefully before installation
- installation should be completed by a suitably qualified person
- please dispose of packaging in a responsible manner

tools required

	Blanking Plug	x1
	Air Vent	x1
	Washer	x4
	Long Screw	x4
	Masonry Wall Plug	x4
	Spacer	x4
	Wall Support	x4
	M5X12Cross Screw	x4
	M6X25CrossScrew	x4

1

Apply PTFE tape(not supplied) to the blanking plug and insert them into the top left threaded holes. Apply PTFE tape(not supplied) to air vent plug and insert them into the top right threaded holes.

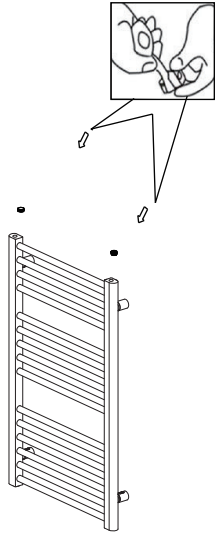

2

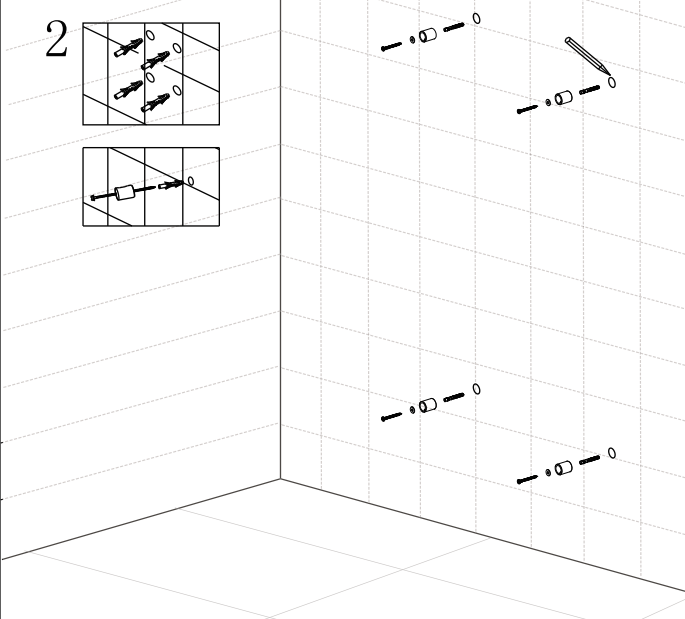

3

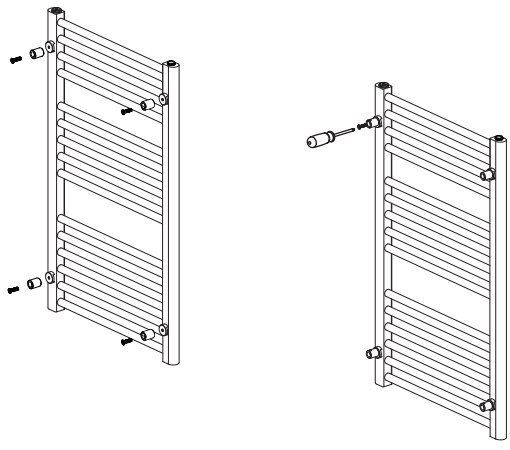

4

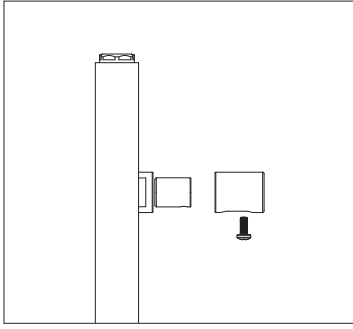

5

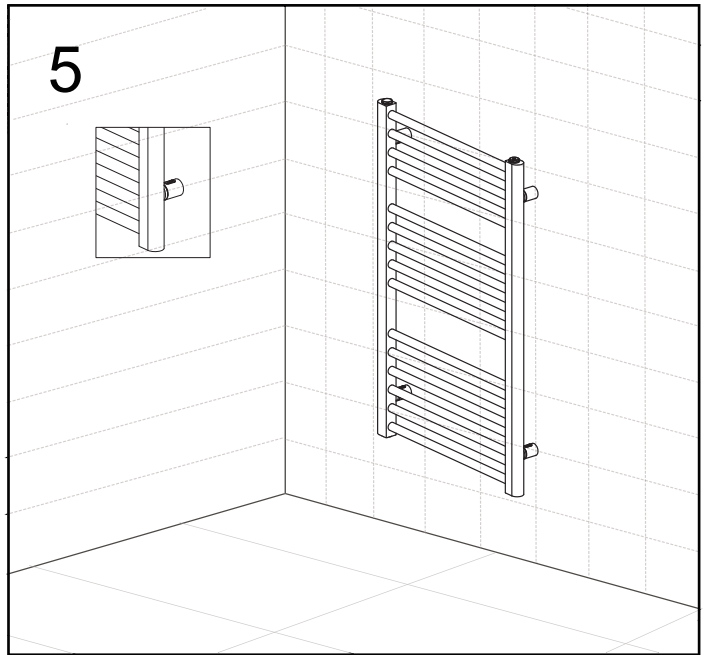

6

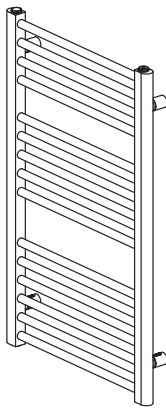

After installation . . .

- Use a screwdriver to open the air vent, open the valve and let the water rush into the towel warmer. Check all connections for leaks.
- Once water overflows from the air vent, there is no air in the tube.
- Use a screwdriver to close the air vent, turn on the valve and the towel warmer is ready for use.

After care . . .

- Classic towel warmers are made from steel with chrome plating, and should not be cleaned with corrosive or scouring cleaning agents.

Please note . . .

· This product can only be used at PN ≤ 1MPa (10g/cm², 10Bar), It should only be filled with water, and at a temperature below 100°C (212°F). See table below for installation requirements.
 If the temperature exceeds 48°C (or 120°F), please install a warning sign near the product to avoid burning and scolding accidents.

Fill ³ / ₄ Full	Pressure	Temperature	Comments
water only	PN ≤ 1 Mpa	0° C < t ≤ 100°C	If ambient temperature drops below 1°C, drain out the water to prevent freezing.