

591980

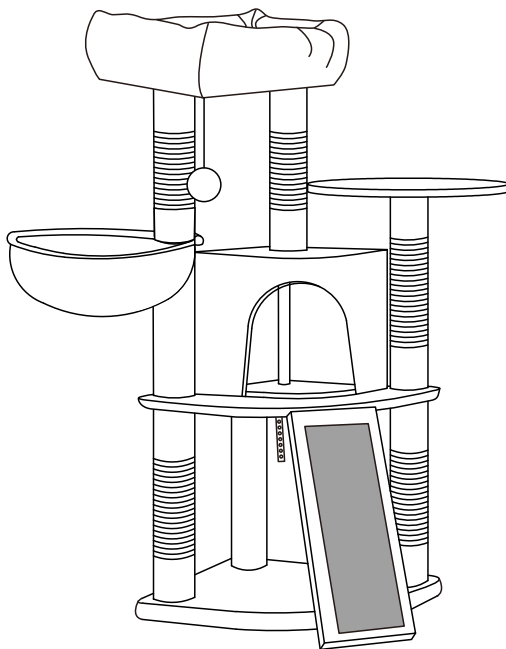

- EN** - Please read this instruction manual carefully before attempting to install.
DE - Bitte lesen Sie diese Bedienungsanleitung vor der Montage gründlich durch.
ES - Por favor lea con atención el manual de instrucciones antes de llevar a cabo el ensamble.
FR - Lisez attentivement cette notice avant de commencer le montage.
IT - Si prega di consultare il libretto delle istruzioni prima del montaggio.

IMPORTANT/WICHTIG/ATENCIÓN

IMPORTANT/IMPORTANTE



EN - We recommend **1** or more people to install.
DE - Wir empfehlen, dass die Montage von **1** oder mehreren Personen durchgeführt werden sollte.
ES - Recomendamos realizar el ensamble con **1** o más personas.
FR - Il est recommandé d'effectuer le montage à **1** personne(s) ou plus.
IT - È necessaria la presenza di **1** o più persone per il montaggio di questo prodotto.



EN - The expected assembly time is **1 h**.
DE - Die Montagezeit beträgt durchschnittlich **1 h**.
ES - El tiempo aproximado de ensamble es de **1 h**.
FR - Le temps nécessaire est estimé à **1 h**.
IT - Il tempo previsto per il corretto assemblaggio è di **1 h**.



EN - Not intended for use by children.
DE - Nicht geeignet für Kinder.
ES - Producto no apto para niños.
FR - Produit non destiné à être utilisé par des enfants.
IT - Questo prodotto non è destinato all'uso da parte dei bambini.



EN - Keep away from fire or other heat sources.
DE - Bitte von Feuer und Hitzequellen fernhalten.
ES - Manténgase alejado de las llamas y otras fuentes de calor.
FR - Tenir à distance des flammes et autres sources de chaleur.
IT - Tenere lontano dal fuoco o da altre fonti di calore.



EN - We recommend wearing protective gloves.
DE - Wir empfehlen das Tragen von Schutzhandschuhen.
ES - Recomendamos el uso de guantes de seguridad.
FR - Il est recommandé de porter des gants de protection.
IT - Per il processo di assemblaggio, consigliamo fortemente l'utilizzo di guanti protettivi.



EN - Please contact us via **help@yaheetech.shop** if you need assistance.
DE - Bitte kontaktieren Sie unseren Kundenservice per E-Mail: **help@yaheetech.shop** für weitere Hilfe.
ES - Si necesita ayuda, por favor póngase en contacto con nosotros a través de **help@yaheetech.shop**.
FR - Besoin d'aide? Contactez-nous via **help@yaheetech.shop**.
IT - Per assistenza o maggiori informazioni, puoi contattarci all'indirizzo mail **help@yaheetech.shop**.

EN - Please follow the instruction manuals and use a pad to avoid damage during assembly.









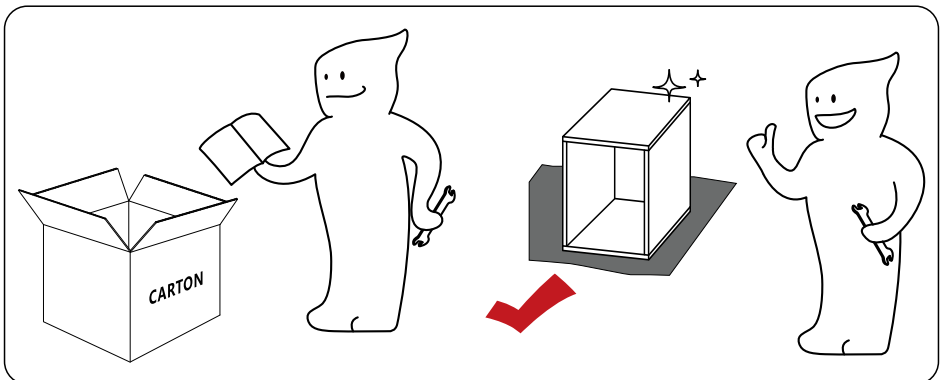
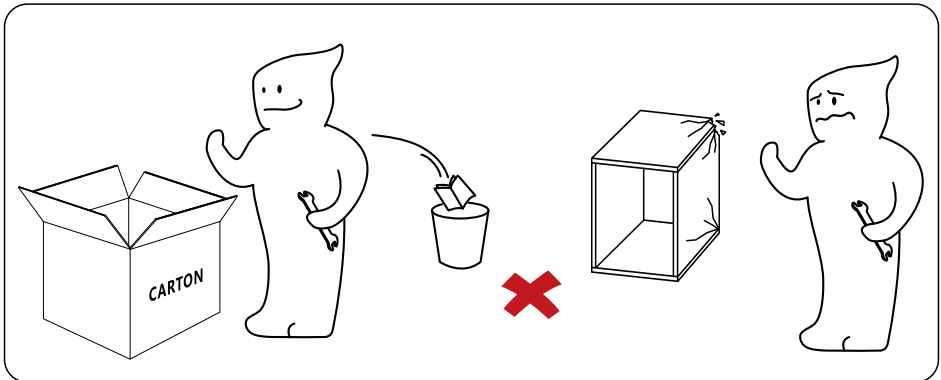

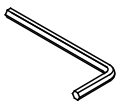
DE - Bitte folgen Sie der Anleitung und verwenden Sie eine Unterlage, um Beschädigungen bei der Montage zu vermeiden.

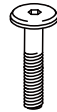
ES - Por favor siga las instrucciones del manual y utilice una cubierta o lona para proteger el producto y los suelos durante la instalación.

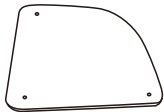
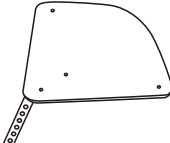
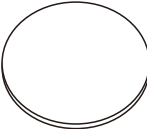
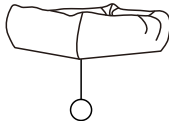

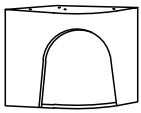
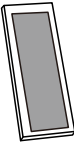
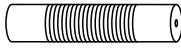
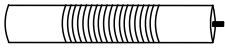
FR - Suivez les instructions de la notice et utilisez une couverture ou une bâche pour protéger le produit et les sols pendant le montage.

IT - Si prega di consultare il manuale illustrativo durante il montaggio e di utilizzare un cuscinetto per evitare possibili danni.

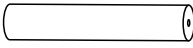
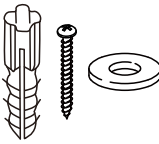



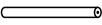

<p>① × 1</p> 	<p>② × 4</p> 	<p>③ × 1</p>  <p>25mm</p>	<p>④ × 13</p>  <p>35mm</p>	<p>⑤ × 3</p> 
<p>⑥ × 2</p> 		<p>⑦ × 1</p> 	<p>⑧ × 1</p> 	
<p>⑨ × 1</p> 	<p>⑩ × 1</p> 	<p>⑪ × 1</p> 		
<p>⑫ × 1</p> 	<p>⑬ × 1</p> 	<p>⑭ × 2</p>  <p>34CM</p>		
<p>⑮ × 1</p> 	<p>⑯ × 1</p>  <p>31CM</p>	<p>⑰ × 1</p>  <p>26.5CM</p>		
<p>⑱ × 3</p> 	<p>⑲ × 2</p>  <p>34CM</p>	<p>⑳ × 1</p> 		

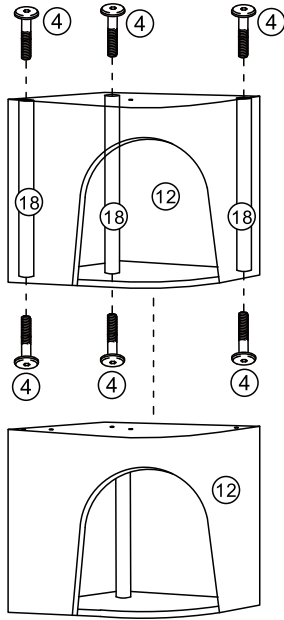
1

(4)		x6
(12)		x1
(18)		x3





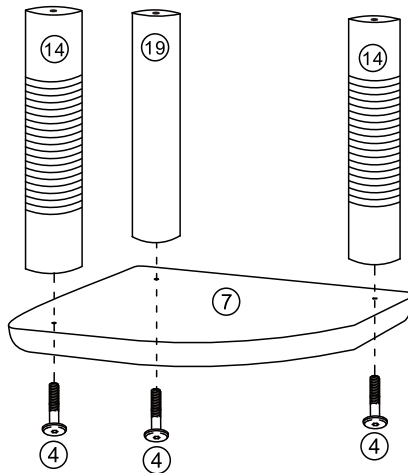

2

(4)		x3
(7)		x1
(14)		x2
(19)		x1





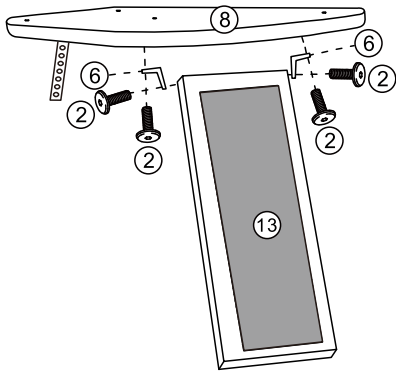

3

②		x4
⑥		x2
⑧		x1
⑬		x1





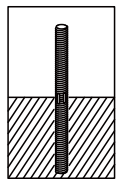
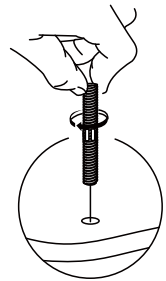
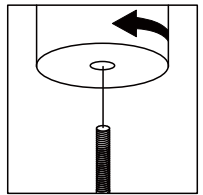
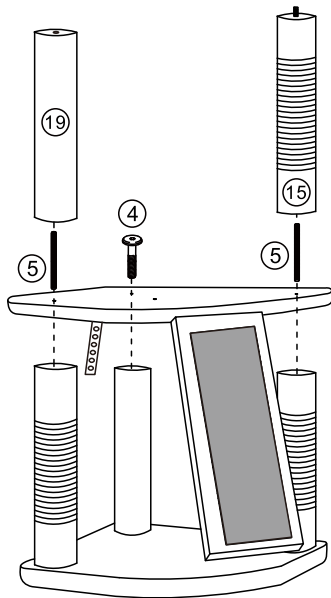

4

④		x1
⑤		x2
⑮		x1
⑲		x1



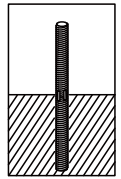
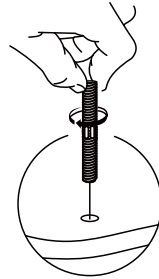
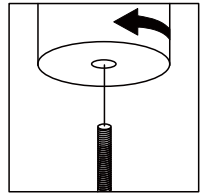
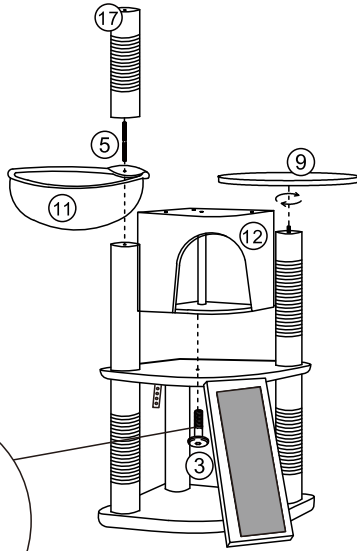
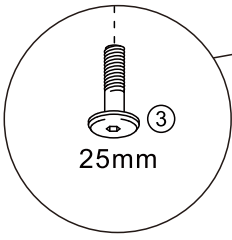

5

③		x1
⑤		x1
⑨		x1
⑪		x1
⑰		x1



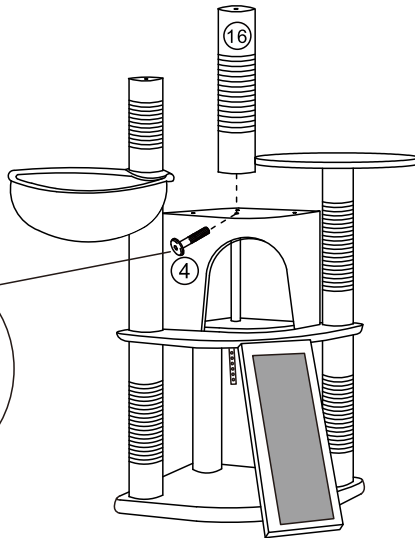
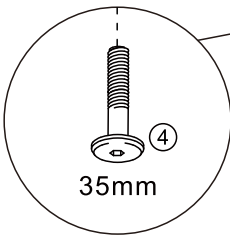

6

④		x1
⑰		x1



7

④		x2
⑩		x1

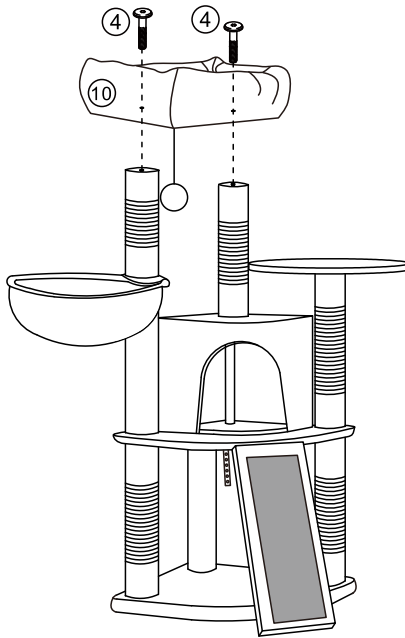

8

⑳		x1
---	-----------------------------------------------------------------------------------	----

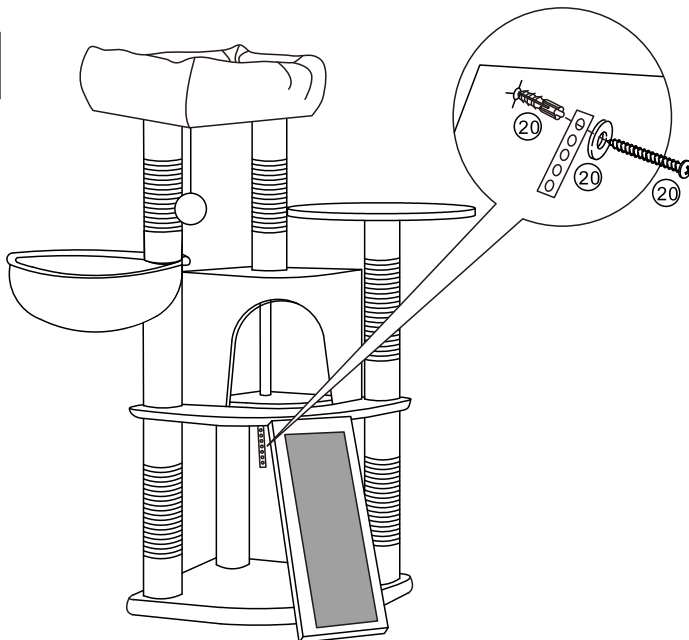

EN



Good job. Would you like to share your experience to assist others with their shopping decisions?



Not good. If you are not satisfied with this shopping experience, please contact us via **help@yaheetech.shop**.

DE



Gut. Wollen Sie Ihre Erfahrungen teilen, um anderen Kunden bei ihrer Kaufentscheidung zu helfen?



Nicht gut. Wenn Sie mit diesem Einkaufserlebnis nicht zufrieden sind, kontaktieren Sie unseren Kundenservice per E-Mail: **help@yaheetech.shop** für weitere Hilfe.



Hergestellt in PRC für Yahee GmbH

Importeur: Yahee GmbH

Hans-Grüninger-Weg 11

71706 Markgröningen

Willkommen auf unserer Webseite, Web: www.yaheetech.de

ES



Satisfecho. ¿Le gustaría compartir su experiencia para ayudar a otros clientes en su compra?



Insatisfecho. Si no está satisfecho con su compra, póngase en contacto con nosotros a través de **help@yaheetech.shop**.

FR



Satisfait. Souhaitez-vous partager votre expérience pour aider d'autres potentiels clients dans leur choix ?



Mécontent. Si vous n'êtes pas satisfait de votre achat, contactez-nous via **help@yaheetech.shop**.

IT



Soddisfatto. Ti piacerebbe condividere la tua esperienza con gli altri utenti?



Insoddisfatto. Se non sei soddisfatto della tua esperienza, si prega di contattarci all'indirizzo mail: **help@yaheetech.shop**.

EN - You can also get a downloadable user manual by scanning the QR code below.

DE - Sie können auch ein herunterladbares Benutzerhandbuch erhalten, indem Sie den QR-Code unten scannen.

ES - Puede descargar una versión digital escaneando el siguiente código QR.

FR - Vous pouvez télécharger une version digitale en scannant le code QR ci-dessous.

IT - Puoi scaricare il libretto delle istruzioni scannerizzando il codice QR in fondo alla pagina.



591980

www.yaheeshop.com/pdf/all-2-5012289.pdf