

591745

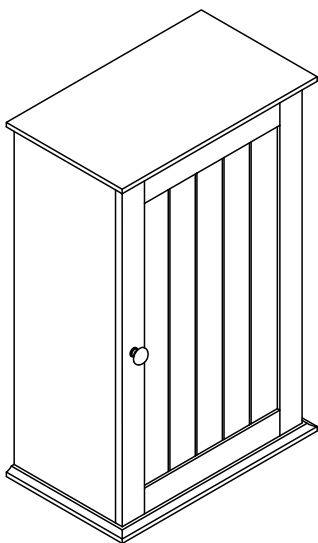

**EN** - Please read this instruction manual carefully before attempting to install.

**DE** - Bitte lesen Sie diese Bedienungsanleitung vor der Montage gründlich durch.

**ES** - Por favor lea con atención el manual de instrucciones antes de llevar a cabo el ensamble.

**FR** - Lisez attentivement cette notice avant de commencer le montage.

**IT** - Si prega di consultare il libretto delle istruzioni prima del montaggio.

# IMPORTANT/WICHTIG/ATENCIÓN

## IMPORTANT/IMPORTANTE



**EN** - We recommend **1** or more people to install.  
**DE** - Wir empfehlen, dass die Montage von **1** oder mehreren Personen durchgeführt werden sollte.  
**ES** - Recomendamos realizar el ensamble con **1** o más personas.  
**FR** - Il est recommandé d'effectuer le montage à **1** personne(s) ou plus.  
**IT** - È necessaria la presenza di **1** o più persone per il montaggio di questo prodotto.



**EN** - The expected assembly time is **1 h**.  
**DE** - Die Montagezeit beträgt durchschnittlich **1 h**.  
**ES** - El tiempo aproximado de ensamble es de **1 h**.  
**FR** - Le temps nécessaire est estimé à **1 h**.  
**IT** - Il tempo previsto per il corretto assemblaggio è di **1 h**.



**EN** - Not intended for use by children.  
**DE** - Nicht geeignet für Kinder.  
**ES** - Producto no apto para niños.  
**FR** - Produit non destiné à être utilisé par des enfants.  
**IT** - Questo prodotto non è destinato all'uso da parte dei bambini.



**EN** - Keep away from fire or other heat sources.  
**DE** - Bitte von Feuer und Hitzequellen fernhalten.  
**ES** - Manténgase alejado de las llamas y otras fuentes de calor.  
**FR** - Tenir à distance des flammes et autres sources de chaleur.  
**IT** - Tenere lontano dal fuoco o da altre fonti di calore.



**EN** - We recommend wearing protective gloves.  
**DE** - Wir empfehlen das Tragen von Schutzhandschuhen.  
**ES** - Recomendamos el uso de guantes de seguridad.  
**FR** - Il est recommandé de porter des gants de protection.  
**IT** - Per il processo di assemblaggio, consigliamo fortemente l'utilizzo di guanti protettivi.

**EN** - Please follow the instruction manuals and use a pad to avoid damage during assembly.









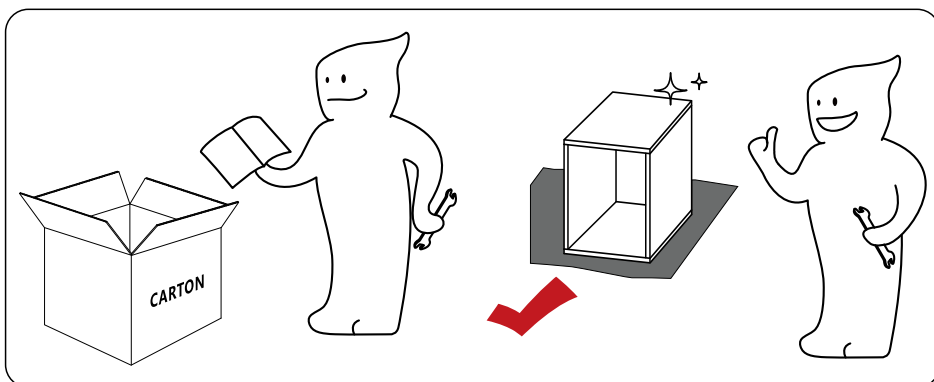
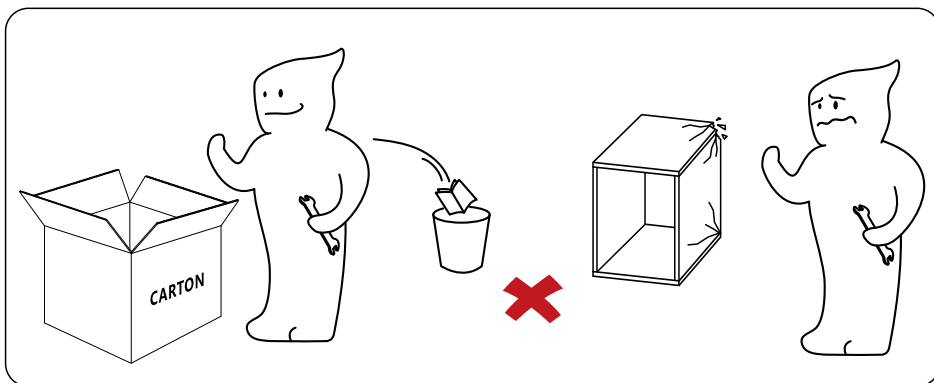

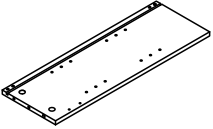
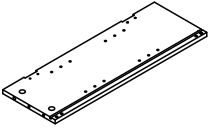
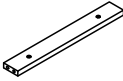
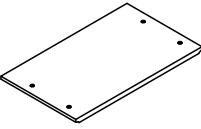
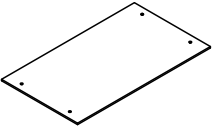
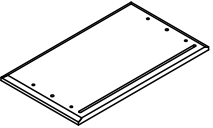
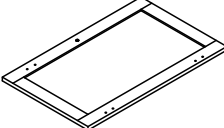
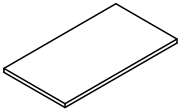
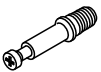

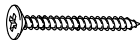
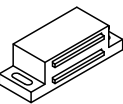
**DE** - Bitte folgen Sie der Anleitung und verwenden Sie eine Unterlage, um Beschädigungen bei der Montage zu vermeiden.

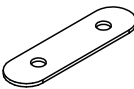
**ES** - Por favor siga las instrucciones del manual y utilice una cubierta o lona para proteger el producto y los suelos durante la instalación.

**FR** - Suivez les instructions de la notice et utilisez une couverture ou une bâche pour protéger le produit et les sols pendant le montage.

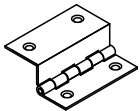
**IT** - Si prega di consultare il manuale illustrativo durante il montaggio e di utilizzare un cuscinetto per evitare possibili danni.

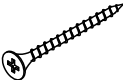

① x1 	② x1 	③ x2 	④ x1 	
⑤ x1 	⑥ x1 	⑦ x1 	⑧ x2 	
Ⓐ x4 	Ⓑ x4 	Ⓒ x12 	Ⓓ x4 	
Ⓔ x1 	Ⓕ x2 	Ⓖ x1 	Ⓗ x10 	
Ⓘ x1 	Ⓙ x1 	Ⓚ x2 	Ⓛ x8 	Ⓜ x4 
Ⓝ x4 				

**EN** - Extra accessories are included. Please use the extra accessories if the original accessories are missing or damaged.

**DE** - Zusätzliches Zubehör ist im Lieferumfang enthalten. Bitte verwenden Sie das zusätzliche Zubehör, wenn das Originalzubehör fehlt oder beschädigt ist.

**ES** - Se incluyen accesorios adicionales. Utilice los accesorios adicionales si los accesorios originales faltan o están dañados.

**FR** - Des éléments supplémentaires sont inclus. Veuillez les utiliser si les éléments d'origine sont manquants ou défectueux.

**IT** - Gli accessori extra sono inclusi. Si prega di utilizzare gli accessori extra se gli accessori originali risultano mancanti o danneggiati.

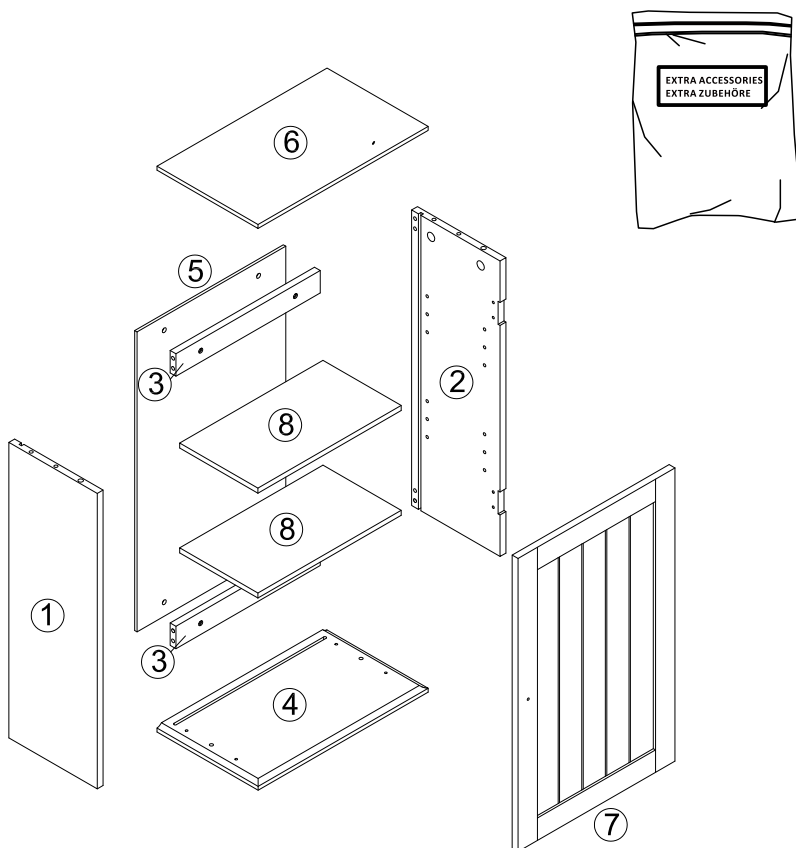

1

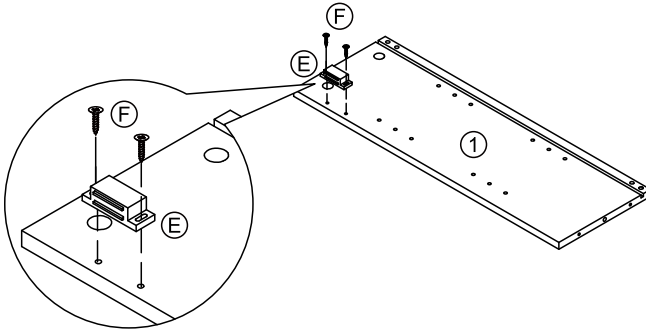
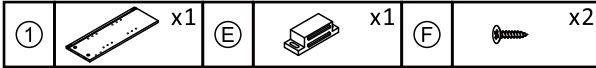

2

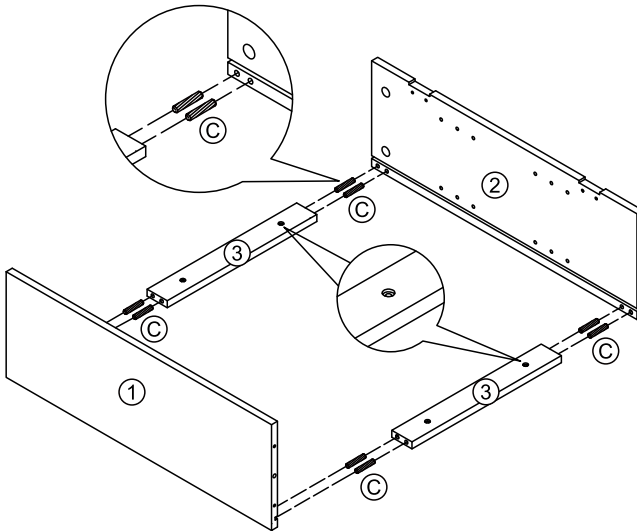
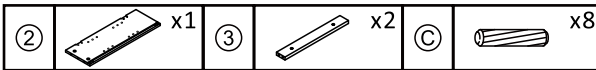

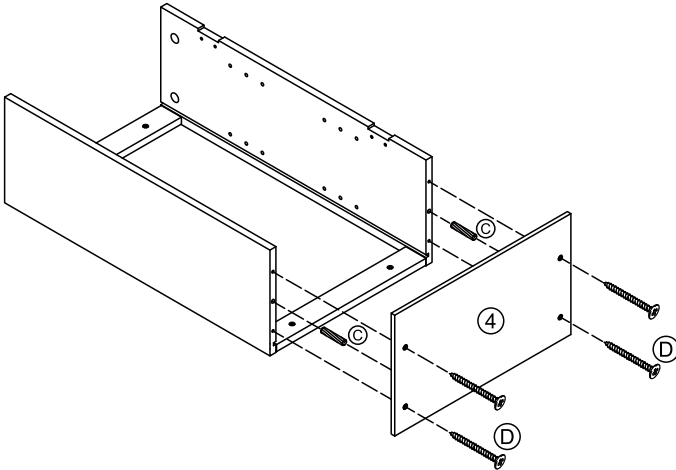
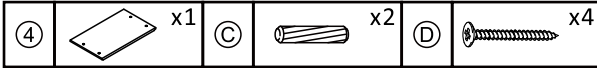

3

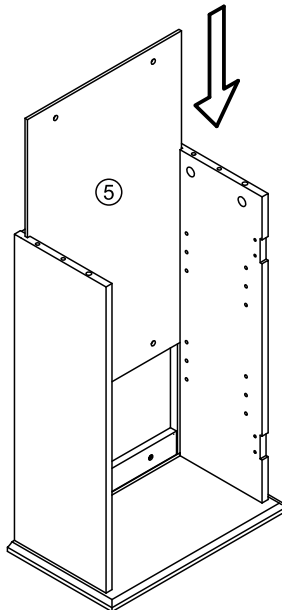
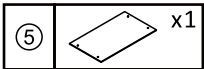

4



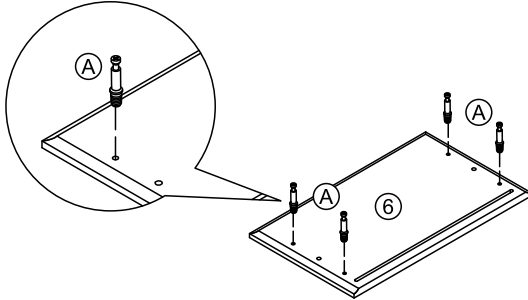

5

⑥		x1	Ⓐ		x4
---	---	----	---	---	----







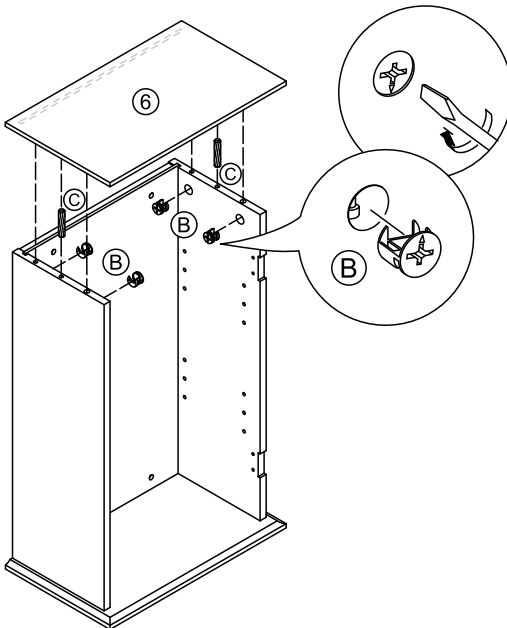

6

Ⓑ		x4
Ⓒ		x2





7

⑦	 x1	⑥	 x1	④	 x6	①	 x1
②	 x1	③	 x2				

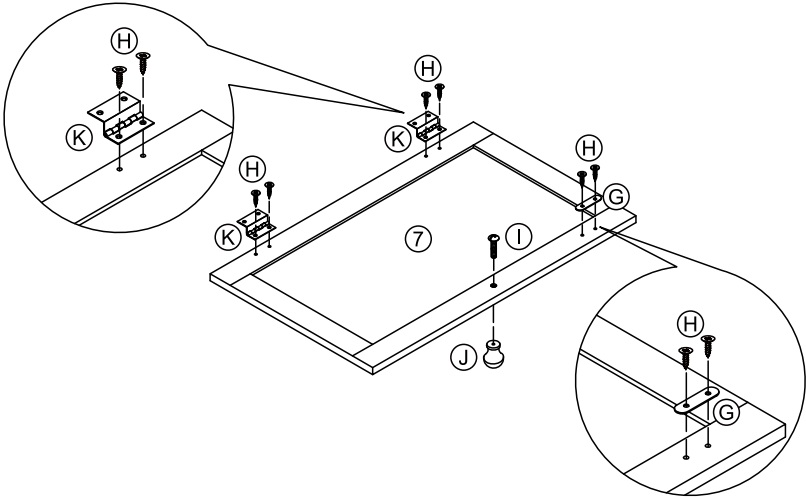

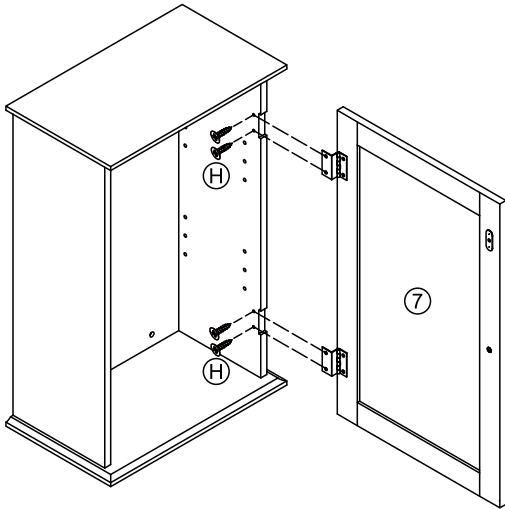

8

④	 x4
---	--



9

⑧		x2
Ⓛ		x8

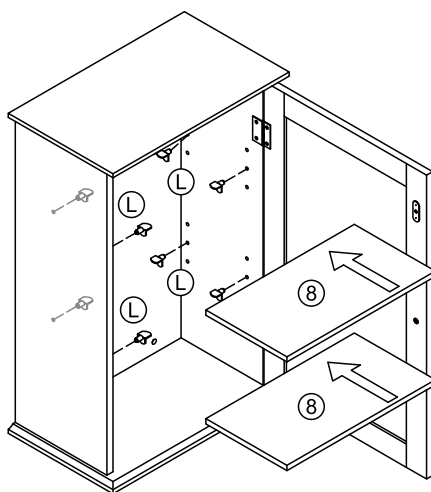

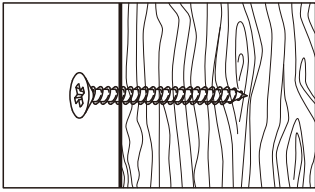

**Drywall or plaster with available wood stud:**

- Mark the attachment point(s) with a pencil at the appropriate height and positioned over wood stud(s).
- Drill a pilot hole(s) with a diameter that matches the screw into the wood stud(s), at the height you marked with pencil.
- Secure the screw to the wood firmly as the picture shows.

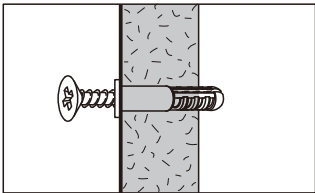

**Drywall without available wood stud:**

- Mark the attachment point(s) with a pencil at the appropriate height.
- Drill a hole(s) with a diameter that matches the plastic anchor through the wall at the height you marked with pencil.
- Drive the plastic plug(s) into the hole(s), using a hammer if needed.
- Insert the screw into the plastic plug firmly as the picture shows. Do not over-tighten.

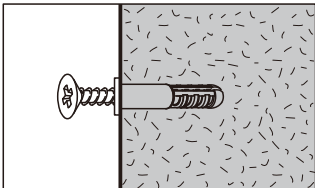

**Masonry:**

- Mark the attachment point(s) with a pencil at the appropriate height.
- Drill a hole(s) with a diameter and depth that match the plastic anchor through the wall at the height you marked with pencil.
- Drive the plastic plug(s) into the hole(s), using a hammer if needed.
- Insert the screw into the plastic plug firmly as the picture shows. Do not over-tighten.

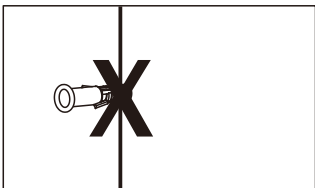

**If the screw can't be secured to the wall, please keep the product away from children.**

**If your wall material is not listed here, or if you have any questions, consult your local hardware store.**

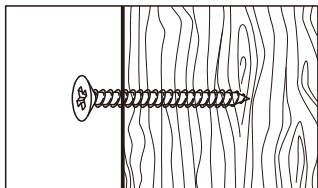

#### Trockenbau mit zugänglicher Holzstruktur:

- Markieren Sie den (die) Befestigungspunkt (e) mit einem Bleistift in der entsprechenden Höhe und über dem (den) Holzständer(n).
- Bohren Sie ein Vorbohrloch bzw. Vorbohrlöcher mit einem zur Schraube passenden Durchmesser in der von Ihnen mit Bleistift markierten Höhe in den/die Holzpfosten.
- Befestigen Sie die Schraube fest im Holz, wie auf dem Bild gezeigt.

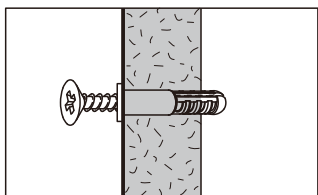

#### Trockenbauwand mit Hohlraum:

- Markieren Sie den (die) Befestigungspunkt(e) mit einem Bleistift in der entsprechenden Höhe.
- Bohren Sie ein Vorbohrloch bzw. Vorbohrlöcher mit einem zum Dübel passenden Durchmesser in der von Ihnen mit Bleistift markierten Höhe in die Trockenbauwand.
- Drücken Sie den/die Kunststoffdübel in das/die Loch/Löcher, wenn nötig mit leichten Hammerschlägen.
- Drehen Sie die Schraube fest in den Kunststoffdübel ein, wie in der Abbildung gezeigt. Nicht zu fest anziehen.

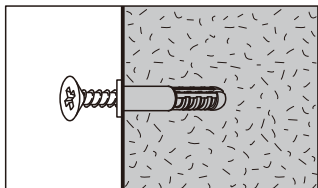

#### Mauerwerk:

- Markieren Sie den (die) Befestigungspunkt(e) mit einem Bleistift in der entsprechenden Höhe.
- Bohren Sie ein Vorbohrloch bzw. Vorbohrlöcher mit einem zum Dübel passenden Durchmesser in der von Ihnen mit Bleistift markierten Höhe in das Mauerwerk.
- Drücken Sie den/die Kunststoffdübel in das/die Loch/Löcher, wenn nötig mit Hammerschlägen.
- Drehen Sie die Schraube fest in den Kunststoffdübel ein, wie in der Abbildung gezeigt. Nicht zu fest anziehen.

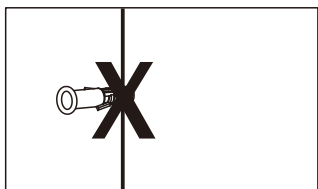

Bitte das Produkt von Kindern fernhalten.

Wenn die Schraube nicht an der Wand befestigt werden kann, oder Ihr Wandmaterial hier nicht aufgeführt ist oder wenn Sie Fragen haben, wenden Sie sich an Ihren örtlichen Eisenwarenhändler.

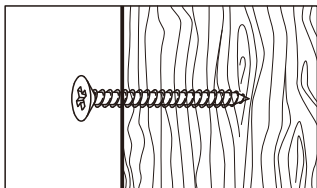

**Paneles de yeso o yeso con montante de madera disponibles:**

- Haga los puntos de fijación con un lápiz a la altura adecuada y coloque sobre los clavos de madera.
- A la altura que marca con un lápiz, taladre un orificio piloto en la clavija con un diámetro que coincida con el tornillo.
- Asegure el tornillo a la madera firmemente como se muestra en la foto.

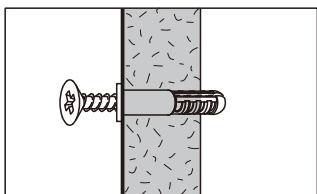

**Panel de yeso sin montante de madera disponible:**

- Haga los puntos de fijación con un lápiz a la altura adecuada.
- Taladre un agujero con un diámetro que coincida con el ancla de plástico a la altura marcada con un lápiz en la pared.
- Introduzca el tapón de plástico en el orificio, utilizando un martillo si es necesario.
- Inserte el tornillo en el tapón de plástico firmemente como se muestra en la imagen. No apriete demasiado.

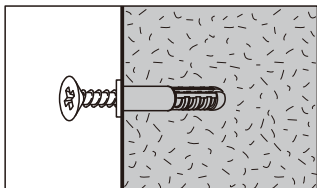

**Albañilería:**

- Haga los puntos de fijación con un lápiz a la altura adecuada.
- Taladre un agujero en la pared con un diámetro y profundidad que coincida con el ancla de plástico a la altura que marca.
- Introduzca el tapón de plástico en el orificio, utilizando un martillo si es necesario.
- Inserte el tornillo en el tapón de plástico firmemente como se muestra en la imagen. No apriete demasiado.

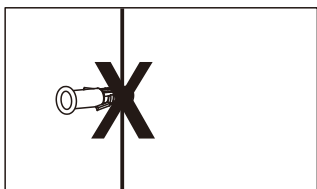

Si el tornillo no se puede fijar a la pared, mantenga el producto alejado de los niños.

Si el material de su pared no figura aquí, o si tiene alguna pregunta, consulte con su ferretería local.

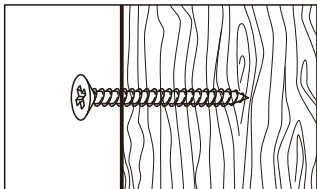

#### Cloison sèche ou plâtre avec du bois:

- Marquez le/les repère(s) de fixation au crayon à la hauteur qui convient sur le/les montants de bois.
- Percez un/des avant-trou(s) d'un diamètre correspondant à celui de la vis sur le repère.
- Fixez fermement la vis dans le bois comme sur le dessin.

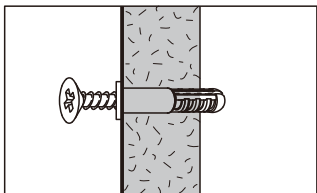

#### Cloison sèche (sans bois):

- Marquez le/les repère(s) de fixation au crayon à la hauteur qui convient.
- Percez un/des trou(s) d'un diamètre correspondant à celui de la cheville en plastique sur le repère.
- Introduisez la/les cheville(s) en plastique dans le/les trou(s), au besoin avec un marteau.
- Insérez la vis dans la cheville fermement, comme sur le dessin. Ne vissez pas trop loin.

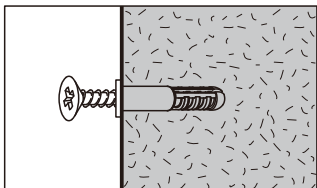

#### Mur plein (béton, pierre...):

- Marquez le/les repère(s) de fixation au crayon à la hauteur qui convient.
- Percez un/des trou(s) d'un diamètre et d'une profondeur correspondant à la cheville en plastique sur le repère.
- Introduisez la/les cheville(s) en plastique dans le/les trou(s), au besoin avec un marteau.
- Insérez la vis dans la cheville fermement, comme sur le dessin. Ne vissez pas trop loin.

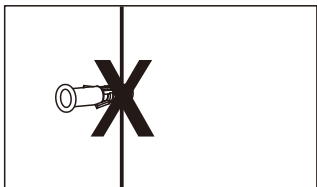

S'il n'est pas possible de fixer le meuble au mur avec une vis, tenir le produit éloigné des enfants.

Si le matériau de votre mur n'est pas listé ici ou si vous avez des questions, renseignez-vous auprès de votre magasin de bricolage.

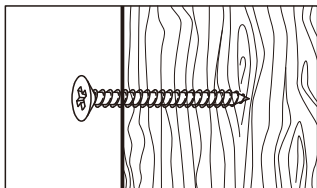

#### **Cartongesso o intonaco con perno di legno disponibile:**

- Con una matita, segnare il punto di fissaggio nell'altezza appropriata e posizionarlo sui perni di legno.
- Forare un punto pilota con un diametro che si accordi con la vite nei perni di legno, nell'altezza segnalata in precedenza con la matita.
- Fissare saldamente la vite come mostra l'immagine.

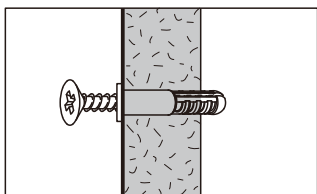

#### **Cartongesso senza perchio di legno disponibile:**

- Segnala un punto di fissaggio con una matita nell'altezza appropriata.
- Forare un punto con un diametro che abbinati la plastica per il fissaggio nel muro, nell'altezza segnalata con la matita.
- Spingere il tappo di plastica attraverso il muro. Usare un martello se necessario.
- Inserire saldamente la vite nel tappo di plastica, come mostrato nell'immagine. Non stringere più del necessario.

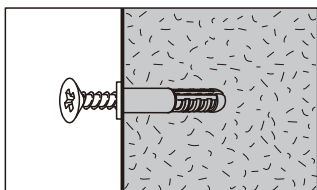

#### **Muratura:**

- Segnala un punto di fissaggio con una matita nell'altezza appropriata.
- Forare un punto con diametro e profondità che si abbinano alla plastica per il fissaggio attraverso il muro, nell'altezza segnalata con la matita.
- Spingere il tappo di plastica nel muro, se necessario utilizzare un martello.
- Inserire saldamente la vite nel tappo di plastica, come mostrato nell'immagine. Non stringere più del necessario.

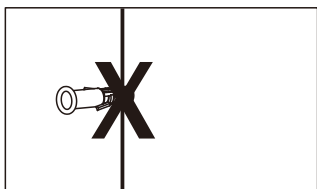

**Se la vite non può essere fissata regolarmente al muro, tenere il prodotto lontano dai bambini.**

**Se il materiale del muro non è presente in questa lista, o in caso di altre domande, consultare il ferramenta della tua zona.**

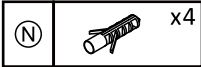

**EN - WALL ANCHORING GUIDE:** Using the guide above, identify your wall material and the appropriate steps to take for that wall material.

**DE - Anleitung zur Wandverankerung:** Ermitteln Sie anhand des folgenden Leitfadens Ihr Wandmaterial und führen Sie dann die entsprechenden Schritte für die Befestigung aus.

**ES - Guía de anclaje a la pared :** utilizando la guía a continuación, identifique el material de la pared y los pasos apropiados a seguir para ese material.

**FR - Guide de fixation murale :** à l'aide du guide plus haut, identifiez la nature du matériau et ainsi les étapes appropriées pour votre mur.

**IT - Guida per il fissaggio a muro:** Consultare la guida qui sopra, identificare il materiale della tua parete e i passaggi più appropriati alle proprie esigenze.

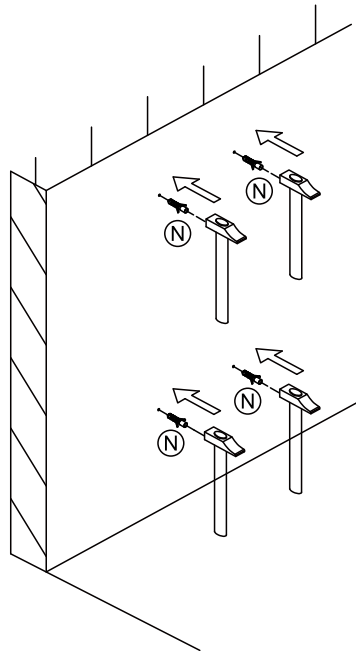
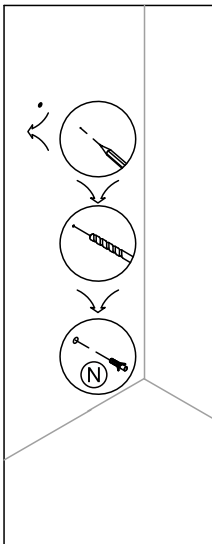



11

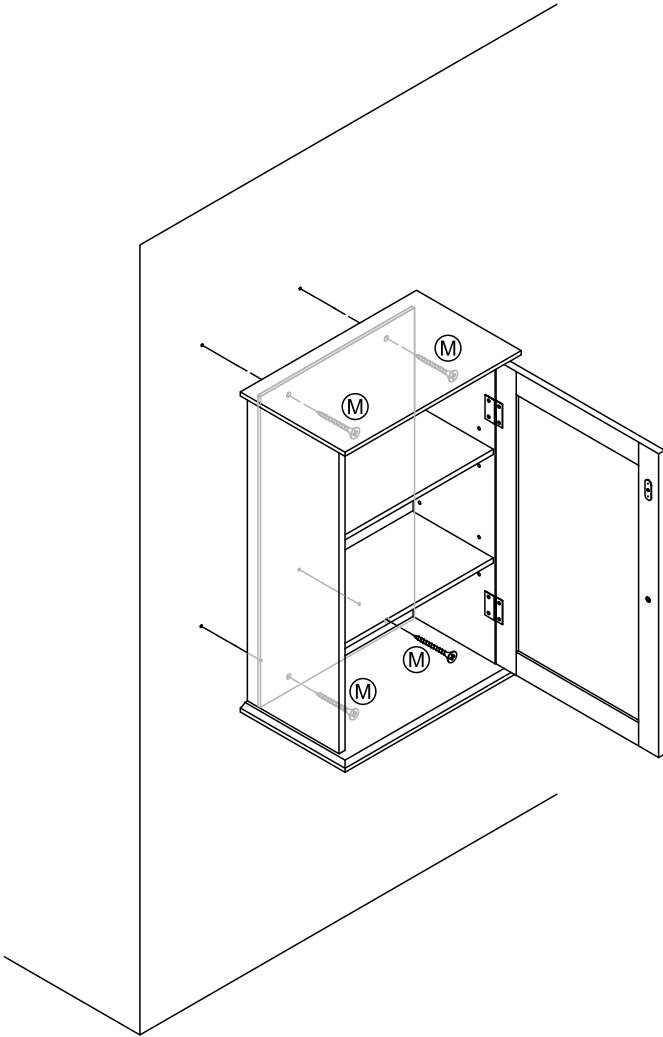
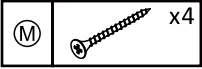

EN



If you are not entirely satisfied with your purchase, please feel free to contact us using the following steps:

1. Go to Your Orders.
2. Find your order in the list.
3. Select Problem with order.
4. Choose your topic from list displayed.
5. Select Contact seller.

DE



Sollten Sie mit Ihrem Kauf nicht zufrieden sein, nehmen Sie bitte in folgenden Schritten mit uns Kontakt auf:

1. Gehen Sie auf die Bestellseite
  2. Suchen Sie Ihre Bestellung in der Bestellliste
  3. Schildern Sie das Problem mit der Bestellung
  4. Thema aus der angezeigten Liste auswählen
  5. Kontakt mit dem Verkäufer aufnehmen.
- Hergestellt in PRC für Yahee GmbH  
Importeur: Yahee GmbH  
Hans-Grüniger-Weg 11  
71706 Markgröningen

ES



Si no está totalmente satisfecho con su compra, no dude en ponerse en contacto con nosotros siguiendo las siguientes instrucciones:

1. Vaya a la lista de sus ordenes de compra.
2. Localice su pedido en la lista.
3. Seleccione el problema en el pedido.
4. Elija un tema de la lista que se muestra.
5. Seleccione Contactar con el vendedor.

FR



Si vous n'êtes pas satisfait de votre achat, veuillez nous contacter en procédant comme suit :

1. Allez sur "Vos commandes"
2. Trouvez votre commande dans la liste.
3. Cliquez sur "Signaler un problème"
4. Sélectionnez une catégorie dans la liste déroulante.
5. Cliquez sur "Contactez le vendeur"

IT



Se non siete soddisfatti di questa esperienza dello shopping, non esitate a contattarci per i seguenti passaggi:

1. Vai ai tuoi ordini.
2. Selezionare "l'ordine interessato".
3. Selezionare il problema con l'ordine.
4. Scegli il tuo argomento dalla lista visualizzata.
5. Selezionare "contatta il venditore".

**EN** - You can also download the electronic Installation Manual from the Product guides and documents section of the advertising page.

**DE** - Das elektronische Installationshandbuch können Sie auch im Bereich Produktführungen und Dokumente der Werbeseite herunterladen.

**ES** - También puede descargar el Manual de instalación electrónica de la Guía del producto y la Sección de documentación de la página de anuncios.

**FR** - Vous pouvez également télécharger le manuel d'installation électronique à partir de la section Guide produit et documentation de la page publicitaire.

**IT** - È inoltre possibile scaricare il manuale di installazione elettronico dalla guida del prodotto e dai documenti nella pagina pubblicitaria.