

INFORMACIÓN

INFORMAÇÃO

BISAGRAS NECESARIAS PARA CADA PUERTA

DOBRADIÇAS NECESSÁRIAS PARA CADA PORTA

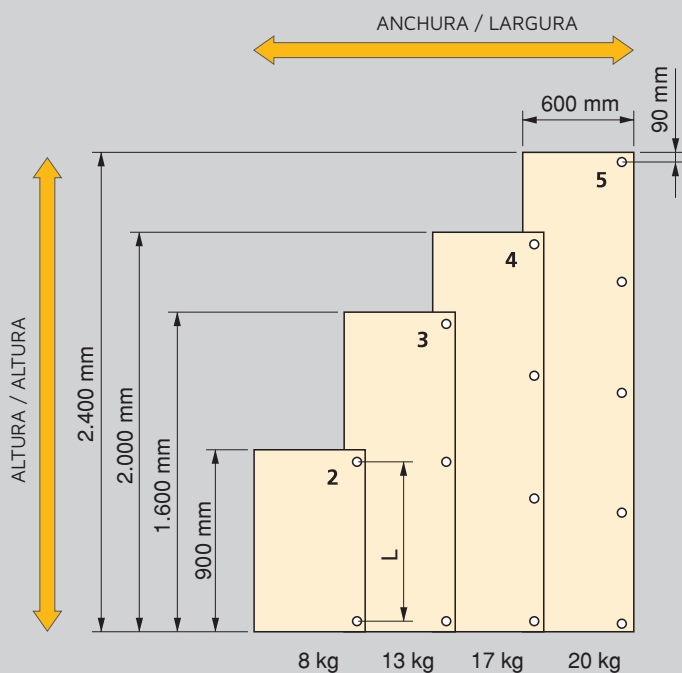

REGULACIONES / REGULAÇÕES

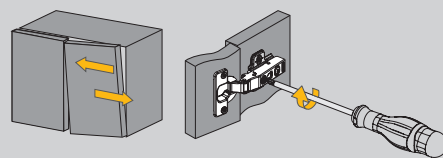

Lateral / Lateral

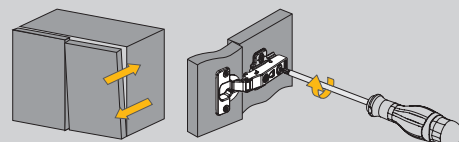

Profundidad / Profundidade

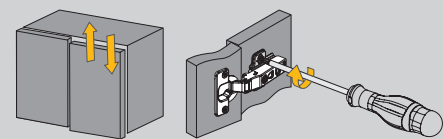

Altura / Altura

CÁLCULO ELECCIÓN DE BASE (B)

¿Qué significa una fórmula $B = 14 + D - S$?

En primer lugar, debemos conocer sus variables:

B = Altura del suplemento
 D = Distancia de taladro de la cazoleta
 S = Solape puerta-costado
 L = Luz mínima
 T = Grosor de la puerta
 M = Grosor del costado
 F = Luz mínima (para puerta sin solape)

REALICEMOS UN EJEMPLO

Un cliente desea localizar una bisagra para conseguir la apertura de una puerta de grosor 16 mm, solapando el costado 15 mm. La distancia de taladro no se puede cambiar y es de 3 mm.

SOLUCIÓN

Como el solape es grande, utilizaremos la bisagra recta.
 La fórmula de la bisagra recta es: $B = 14 + D - S$.
 Conocemos los valores: $D = 3$ y $S = 15$

Substituyendo en la fórmula:
 $B = 14 + 3 - 15 = 17 - 15 = 2$ **B = 2**
 Así pues, con la bisagra recta y la base de 2mm el problema queda resuelto.

CÁLCULO DE ESCOLHA DA BASE (B)

¿O que significa uma fórmula $B = 14 + D - S$?

Em primeiro lugar, devemos conhecer as suas variáveis:

B = Altura do calço
 D = Distância do furo do copo
 S = Sobreposição da porta sobre a ilharga
 L = Luz mínima
 T = Grossura da porta
 M = Grossura da ilharga
 F = Luz mínima (para porta sem sobreposição na ilharga)

FAÇAMOS UM EXEMPLO

Um cliente deseja colocar uma dobradiça para conseguir a abertura de uma porta de grossura 16 mm, sobrepondo a ilharga 15 mm. A distância do furo não se pode mudar e é de 3 mm.

SOLUÇÃO

Como a sobreposição é grande, utilizaremos a dobradiça recta.
 A fórmula da dobradiça recta é: $B = 14 + D - S$.
 Conhecemos os valores: $D = 3$ e $S = 15$

Substituindo na fórmula obtemos:
 $B = 14 + 3 - 15 = 17 - 15 = 2$ **B = 2**
 Assim sendo, com a dobradiça recta e a base de 2mm o problema fica resolvido.

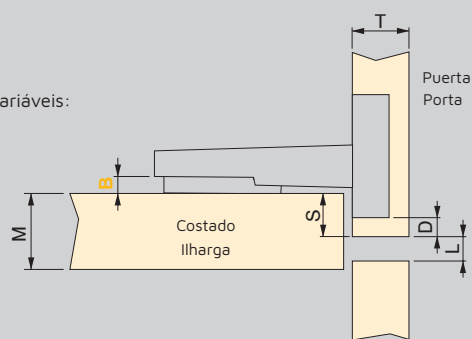

INFORMAZIONI INFORMATION

NUMERO DI CERNIERE NECESSARIE PER OGNI PORTA CHARNIÈRES NÉCESSAIRES POUR CHAQUE PORTE

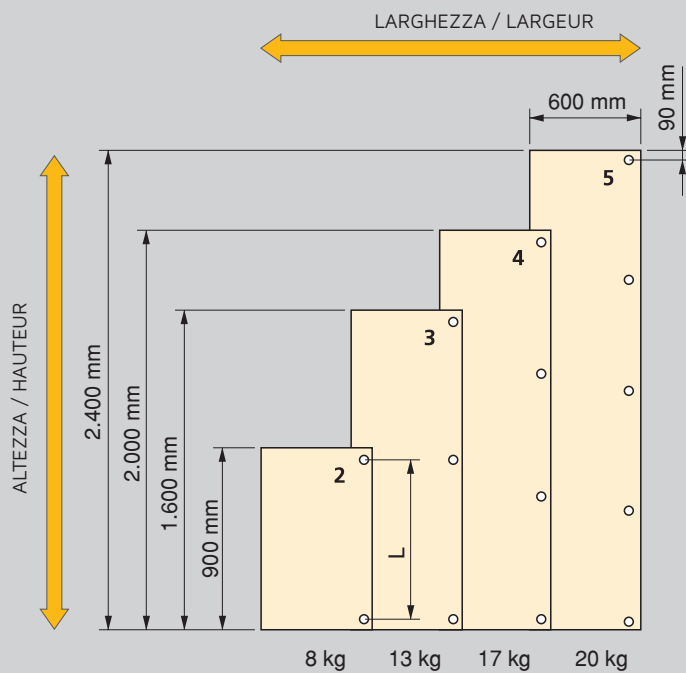

REGOLAZIONI / RÉGLAGES

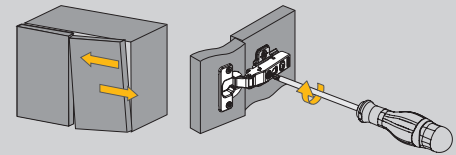

Laterale / Latéral

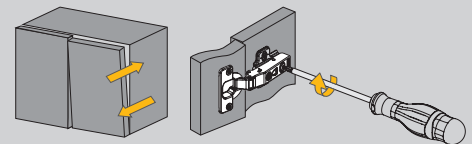

Profondità / Profondeur

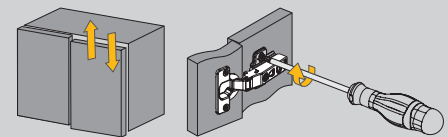

Altezza / Hauteur

CALCOLO PER SCELTA DELLA BASETTA (B)

Cosa significa una formula del tipo $B = 14 + D - S$?

Come prima cosa, per conoscere una formula dobbiamo conoscere le variabili:

B = Altezza della basetta
D = Distanza di foratura dello scodellino
S = Sormonto porta -fianco
L = Luce minima
T = Spessore della porta
M = Spessore del fianco
F = Luce minima (per porta in sormonto)

REALIZZIAMO UN ESEMPIO:

Un cliente desidera mettere una cerniera per ottenere una apertura di una porta di spessore 16 mm, con sormonto al fianco di 15 mm. La distanza di foratura dello scodellino non può essere cambiata ed è di 3 mm.

SOLUZIONE:

Dato che il sormonto è grande, utilizziamo una cerniera collo dritto .
La formula della cerniera dritti è $B = 14 + D - S$.
Conosciamo i valori $D = 3$ e $S = 15$

Sostituiamo nella formula:

$B = 14 + 3 - 15 = 17 - 15 = 2$ **B = 2**
In tal caso, con la cerniera dritta e la base da 2mm il problema rimane risolto.

CALCUL POUR CHOISIR LES CHARNIÈRES DE BASE (B)

Que signifie une formule type $B = 14 + D - S$?

Pour connaître une formule il faut tout d'abord connaître ses variables:

B = Hauteur de la Base
D = Distance de perçage du boîtier
S = Recouvrement porte-côté
L = Éclairage minimum
T = Épaisseur de la porte
M = Épaisseur du côté
F = Éclairage minimum (pour porte sans recouvrement)

VOYONS UN EXEMPLE:

Un client a besoin d'une charnière pour l'ouverture d'une porte de 16 mm d'épaisseur, avec un recouvrement de 15 mm du côté. La distance de perçage est de 3 mm et ne peut pas être modifiée.

SOLUTION:

S'agissant d'un grand recouvrement, on devra utiliser une charnière droite.
La formule de la charnière droite est $B = 14 + D - S$.
Nous connaissons les valeurs $D = 3$ et $S = 15$

En substituant dans la formule:

$B = 14 + 3 - 15 = 17 - 15 = 2$ **B = 2**
Donc, avec la charnière droite et une base de 2mm le problème est résolu.

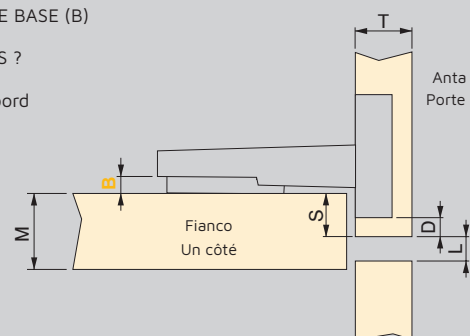

INFORMATION INFORMATION

NUMBER OF HINGES NEEDED FOR EACH DOOR FÜR JEDE TÜR BENÖTIGTE SCHARNIERE

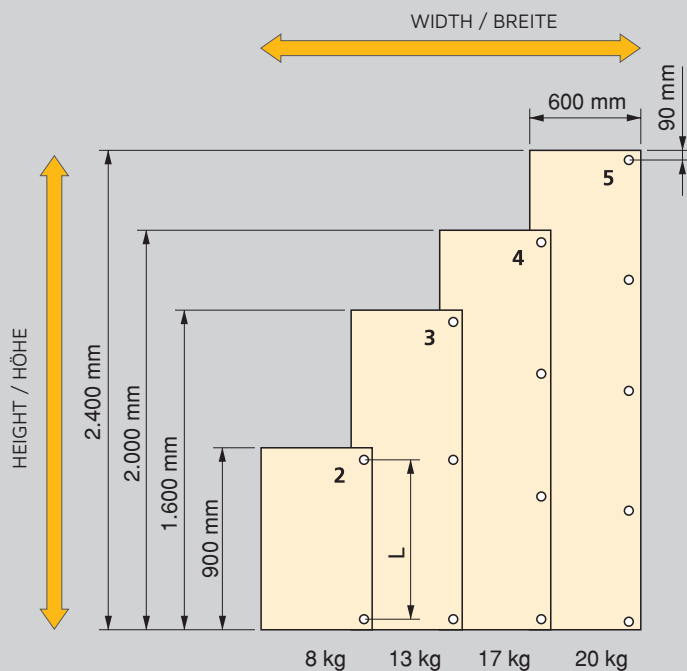

ADJUSTMENT / REGULIERUNG

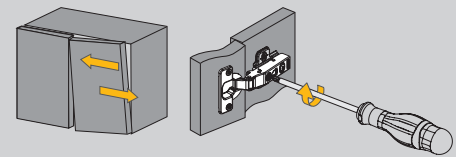

Laterally / Seitlich

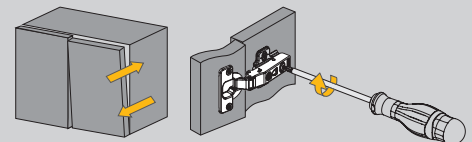

Depth / Tiefe

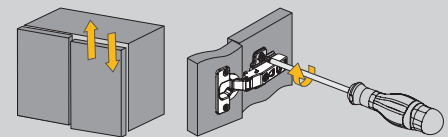

Height / Höhe

CALCULATION FOR CHOOSING THE HINGE PLATE (B)

What does a formula like $B = 14 + D - S$ mean?
First of all, in order to understand a formula we need to

know what its variables are:

- B = Thickness of the Plate
- D = Drilling distance of hinge cup
- S = Door- jamb overhang
- L = Minimum opening
- T = Thickness of the door
- M = Thickness of the jamb
- F = Minimum opening (for doors without overhang)

HERE IS AN EXAMPLE:

A client wishes to place a hinge so that a 16 mm door which overhangs the jamb by 15 mm opens correctly. The hinge cup diameter is 3 mm and cannot be changed.

SOLUTION

As the overhang is quite generous, we will use a straight cupboard hinge. The formula for a straight cupboard hinge is $B = 14 + D - S$. We know the values of $D = 3$ and $S = 15$

Substituting them into the formula we get:

$$B = 14 + 3 - 15 = 17 - 15 = 2 \quad B = 2$$

So then, with a straight cupboard hinge and a 2mm plate the problem is solved.

BERECHNUNG FÜR DIE AUSWAHL DER PLATTE (B)

Was bedeutet die Formel $B = 14 + D - S$?
Erstens müssen wir die Variablen kennen

- B = Höhe der Montageplatte
- D = Lochabstand im Topf
- S = Überlappung Tür-Bordwand
- L = Minimales Licht
- T = Dicke der Tür
- M = Dicke der Bordwand
- F = Minimales Licht (für nicht überlappende Türen)

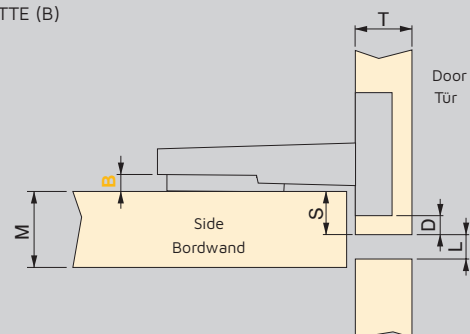

MIT EINEM BEISPIEL:

Ein Kunde möchte ein Scharnier zum Öffnen einer Tür mit einer Dicke von 16 mm wählen, das die Seitenwand 15 mm überlappt. Der Bohrabstand kann nicht verändert werden und beträgt 3 mm.

LÖSUNG

Da die Überlappung groß ist, verwenden wir das gerade Scharnier. Die Formel für das gerade Scharnier lautet: $B = 14 + D - S$. Wir kennen die Werte: $D = 3$ und $S = 15$

Setzen Sie diese Zahlen in die Formel ein:

$$B = 14 + 3 - 15 = 17 - 15 = 2 \quad B = 2$$

Mit dem geraden Scharnier und der 2mm Basis ist das Problem also gelöst.

INFORMATION INFORMACJE

NUMBER OF HINGES NEEDED FOR EACH DOOR LICZBA ZAWIASÓW POTRZEBNA NA KAŻDE DRZWI

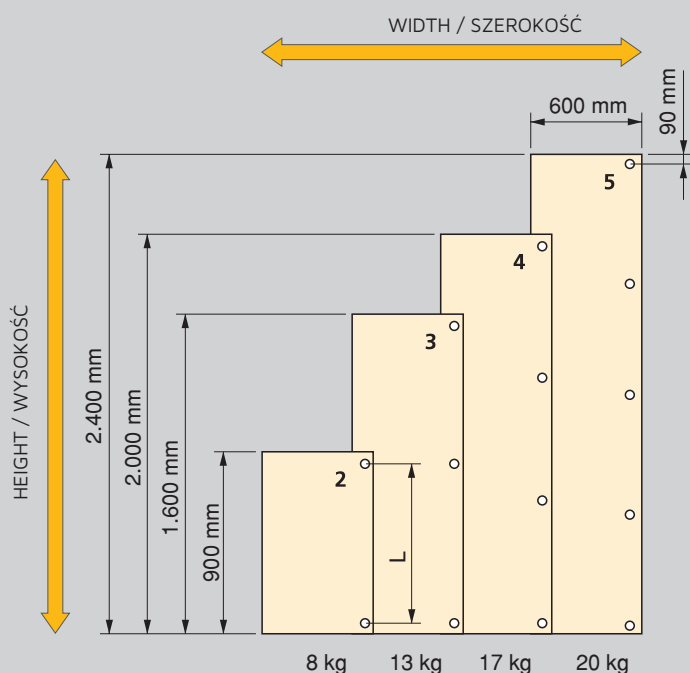

ADJUSTMENT / REGULACJA

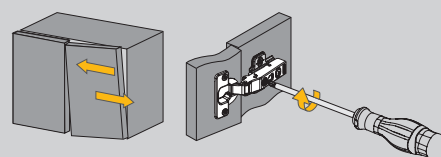

Laterally / Boczna

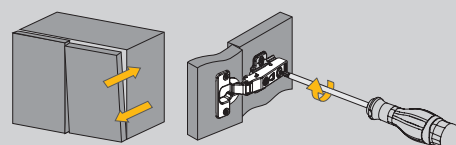

Depth / Głębokość

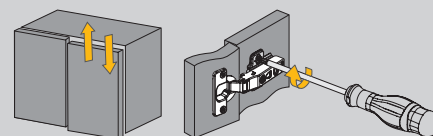

Height / Wysokość

CALCULATION FOR CHOOSING THE HINGE PLATE (B)

What does a formula like $B = 14 + D - S$ mean? First of all, in order to understand a formula we need to

know what its variables are:

B = Thickness of the Plate

D = Drilling distance of hinge cup

S = Door-jamb overhang

L = Minimum opening

T = Thickness of the door

M = Thickness of the jamb

F = Minimum opening

(for doors without overhang)

OBLICZENIA DO WYBORU PROWADNIKA ZAWIASU (B)

Co oznacza równanie $B = 14 + D - S$?

Po pierwsze, w celu zrozumienia formuły musimy wiedzieć co oznaczają zmienne:

B = grubość prowadnika

D = średnica puszk

S = wysięg ościeżnicy

L = minimalne otwarcie

T = grubość drzwi

M = grubość ościeżnicy

F = minimalne otwarcie

(do drzwi bezościeżnicowych)

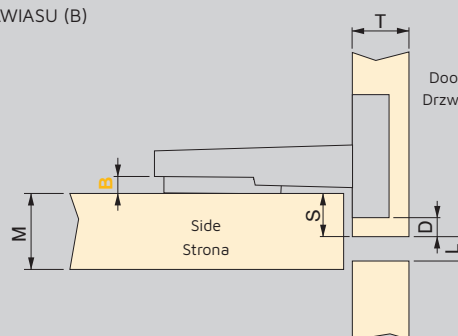

HERE IS AN EXAMPLE:

A client wishes to place a hinge so that a 16 mm door which overhangs the jamb by 15 mm opens correctly. The hinge cup diameter is 3 mm and cannot be changed.

SOLUTION

As the overhang is quite generous, we will use a straight cupboard hinge.

The formula for a straight cupboard hinge is $B = 14 + D - S$.

We know the values of $D = 3$ and $S = 15$

Substituting them into the formula we get:

$$B = 14 + 3 - 15 = 17 - 15 = 2 \quad B = 2$$

So then, with a straight cupboard hinge and a 2mm plate the problem is solved.

OTO PRZYKŁAD:

Klient chce zamontować zawias tak, żeby 16 mm drzwi których ościeżnica wystaje o 15 mm otwierają się. Puszka zawiasu ma 3 mm nie można jej zmienić.

ROZWIĄZANIE

Ponieważ wysięg jest dość duży, użyjemy prostego zawiasu do szafki.

Równanie dla zwykłego zawiasu do szafki to $B = 14 + D - S$.

Znamy wartości $D = 3$ i $S = 15$

Wprowadzając je do równania otrzymujemy:

$$B = 14 + 3 - 15 = 17 - 15 = 2 \quad B = 2$$



Oznacza to, że wystarczy nam prosty zawias do szafki i 2mm prowadnik.

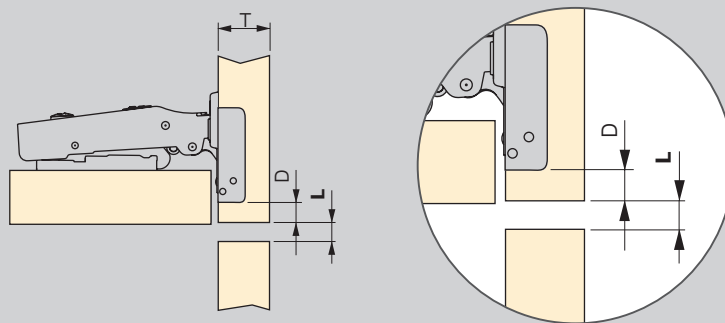

INFORMACIÓN

INFORMACÃO

DISTANCIA MÍNIMA PUERTA CONTIGUA
 DISTÂNCIA MÍNIMA PORTA CONTIGUA





X91 Ø35  												
	L	T=14	T=15	T=16	T=17	T=18	T=19	T=20	T=21	T=22	T=23	T=24
X91N Ø35  105°	D=3	0,4	0,6	0,8	1,1	1,4	1,8	2,3	2,7	3,3	4,1	4,9
	D=4	0,4	0,6	0,9	1,1	1,4	1,8	2,2	2,6	3,1	3,8	4,5
	D=5	0,4	0,6	0,9	1,1	1,4	1,8	2,1	2,5	3,	3,5	4,2
	D=6	0,4	0,6	0,9	1,1	1,4	1,7	2,0	2,4	2,8	3,4	3,9
	D=7	0,4	0,6	0,9	1,1	1,4	1,6	1,9	2,3	2,7	3,2	3,7

X91 Ø35  										
	L	T=16	T=17	T=18	T=19	T=20	T=21	T=22	T=23	T=24
X91N Ø35  165°	D=3	0,5	0,5	0,5	0,5	0,5	0,5	0,5	0,5	0,5
	D=4	0,5	0,5	0,5	0,5	0,5	0,5	0,5	0,5	0,5
	D=5	0,5	0,5	0,5	0,5	0,5	0,5	0,5	0,5	0,5
	D=6	0,5	0,5	0,5	0,5	0,5	0,5	0,5	0,5	0,5
	D=7	0,5	0,5	0,5	0,5	0,5	0,5	0,5	0,5	0,5



X92 Ø35  												
	L	T=14	T=15	T=16	T=17	T=18	T=19	T=20	T=21	T=22	T=23	T=24
X92N Ø35  105°	D=3	0,6	0,7	1,0	1,3	1,6	2,0	2,5	3,0	3,5	4,1	4,7
	D=4	0,5	0,7	1,0	1,2	1,6	1,9	2,3	2,8	3,3	3,9	4,5
	D=5	0,5	0,7	1,0	1,2	1,5	1,9	2,2	2,7	3,2	3,8	4,4
	D=6	0,5	0,7	0,9	1,2	1,5	1,8	2,2	2,6	3,0	3,6	4,2
	D=7	0,5	0,7	0,9	1,1	1,4	1,7	2,1	2,5	2,9	3,4	3,9

X95 Ø35  												
	L	T=14	T=15	T=16	T=17	T=18	T=19	T=20	T=21	T=22	T=23	T=24
	D=3	0,3	0,45	0,65	0,85	1,15	1,5	1,9	3,15	3,15	3,9	4,75
	D=4	0,3	0,45	0,65	0,85	1,1	1,4	1,8	2,8	2,80	3,55	4,3
	D=5	0,3	0,45	0,65	0,75	1,0	1,35	1,7	2,65	2,65	3,25	3,95
	D=6	0,25	0,4	0,6	0,75	1,0	1,3	1,65	2,5	2,5	3,0	3,65
	D=7	0,25	0,4	0,6	0,7	0,95	1,25	1,5	2,35	2,35	2,85	3,45

X50 Ø35  												
	L	T=14	T=15	T=16	T=17	T=18	T=19	T=20	T=21	T=22	T=23	T=24
	D=3	0,25	0,40	0,75	1,05	1,40	1,80	2,30	2,90	3,60	4,40	5,20
	D=4	0,25	0,40	0,75	1,00	1,30	1,70	2,15	2,70	3,30	4,05	4,80
	D=5	0,25	0,40	0,70	0,95	1,25	1,60	2,05	2,50	3,10	3,75	4,45
	D=6	0,2	0,35	0,70	0,95	1,20	1,55	1,95	2,40	2,90	3,50	4,15
	D=7	0,2	0,35	0,65	0,90	1,15	1,50	1,85	2,25	2,75	3,30	3,90

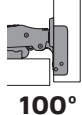

X12 Ø26  								
	L	T=12	T=13	T=14	T=15	T=16	T=17	T=18
	D=3	0,3	0,5	0,8	1,2	1,6	2,3	3,0
	D=4	0,3	0,5	0,8	1,1	1,5	2,0	2,7
	D=5	0,3	0,5	0,8	1,0	1,4	1,8	2,4
	D=6	0,3	0,5	0,8	1,0	1,3	1,7	2,2

C91E Ø35		 100°	L	T=14	T=15	T=16	T=17	T=18	T=19	T=20	T=21	T=22	T=23	T=24
			D=3	0,2	0,4	0,6	0,8	1,1	1,5	2,0	2,7	3,5	4,3	5,1
			D=4	0,2	0,4	0,6	0,8	1,1	1,4	1,9	2,4	3,1	3,9	4,7
			D=5	0,2	0,3	0,5	0,8	1,0	1,4	1,8	2,3	2,9	3,5	4,3
			D=6	0,2	0,3	0,5	0,7	1,0	1,3	1,7	2,1	2,6	3,3	4,0
D=7	0,2	0,3	0,5	0,7	0,9	1,2	1,6	2,0	2,5	3,0	3,7			

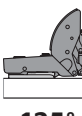
C91 Ø35		 155°	L	T=16	T=17	T=18	T=19	T=20	T=21	T=22	T=23	T=24	
			D=3	0,0	0,0	0,0	0,0	0,0	0,0	0,0	0,0	0,0	0,0
			D=4	0,0	0,0	0,0	0,0	0,0	0,0	0,0	0,0	0,0	0,0
			D=5	0,0	0,0	0,0	0,0	0,0	0,0	0,0	0,0	0,0	0,0
			D=6	0,0	0,0	0,0	0,0	0,0	0,0	0,0	0,0	0,0	0,0

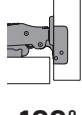
C91 Ø35		 125°	L	T=3	T=4	T=5	T=6
			D=1,5	13,6	14,4	15,2	16,1
			D=3,0	11,2	12,1	12,9	13,8
			D=4,5	8,9	9,8	10,7	11,6
			D=6,0	6,8	7,7	8,6	9,5
			D=7,5	4,2	5,0	5,8	6,6
			D=8,0	2,8	3,8	4,8	5,8
D=16,5	0,0	0,0	0,3	0,8			

C91E Ø26		 100°	L	T=12	T=13	T=14	T=15	T=16	T=17	T=18	T=19	T=20	T=21	T=22
			D=3	0,5	0,8	1,1	1,4	1,9	2,6	3,4	4,2	5,1	6,0	6,9
			D=4	0,5	0,7	1,0	1,4	1,8	2,3	3,0	3,8	4,6	5,4	6,3
			D=5	0,5	0,7	1,0	1,3	1,7	2,2	2,8	3,4	4,2	5,0	5,8
			D=6	0,4	0,6	0,9	1,2	1,6	2,0	2,5	3,2	3,9	4,6	5,4
			D=7	0,4	0,6	0,9	1,2	1,5	1,9	2,4	2,9	3,6	4,3	5,0

C95 Ø35	 	 110°	L	T=14	T=15	T=16	T=17	T=18	T=19	T=20	T=21	T=22	T=23	T=24
			D=3	0,25	0,40	0,60	0,80	1,10	1,45	1,85	2,40	3,10	3,85	4,70
			D=4	0,25	0,40	0,60	0,80	1,05	1,35	1,75	2,20	2,75	3,50	4,25
			D=5	0,25	0,40	0,60	0,70	1,00	1,30	1,65	2,10	2,60	3,20	3,90
			D=6	0,2	0,35	0,55	0,70	0,95	1,25	1,60	2,00	2,45	3,00	3,60
			D=7	0,2	0,35	0,55	0,65	0,90	1,20	1,50	1,90	2,30	2,80	3,40

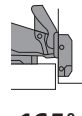
C95 Ø35		 165°	L	T=14	T=15	T=16	T=17	T=18	T=19	T=20	T=21	T=22	T=23	T=24	T=25	T=26
			D=3	0,0	0,0	0,0	0,0	0,0	0,0	0,0	0,0	0,0	0,2	0,6	1,1	4,4
			D=4	0,0	0,0	0,0	0,0	0,0	0,0	0,0	0,0	0,0	0,3	0,7	2,4	3,6
			D=5	0,0	0,0	0,0	0,0	0,0	0,0	0,0	0,0	0,0	0,3	0,9	2,0	2,9
			D=6	0,0	0,0	0,0	0,0	0,0	0,0	0,0	0,0	0,0	0,3	0,8	1,5	2,3
			D=7	0,0	0,0	0,0	0,0	0,0	0,0	0,0	0,0	0,0	0,2	0,6	1,2	1,9
			D=8	0,0	0,0	0,0	0,0	0,0	0,0	0,0	0,0	0,0	0,2	0,5	1,0	1,6

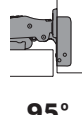
C95 Ø40		 95°	L	T=20	T=21	T=22	T=23	T=24	T=25	T=26	T=27	T=28	T=29	T=30	T=31	T=32	T=33	T=34	T=35	T=36	T=37	T=38	T=39	T=40
			D=3	0,75	0,90	1,10	1,25	1,45	1,70	1,90	2,15	2,45	2,70	3,55	4,50	5,40	6,35	7,30	8,30	9,25	10,20	11,20	12,15	13,15
			D=4	0,75	0,90	1,10	1,20	1,40	1,65	1,90	2,10	2,40	2,65	3,00	3,90	4,75	5,75	6,80	7,70	8,65	9,60	10,55	11,50	12,50
			D=5	0,75	0,90	1,05	1,20	1,40	1,60	1,85	2,10	2,35	2,60	2,90	3,30	4,20	5,10	6,00	6,90	7,85	8,80	9,70	10,70	11,65
			D=6	0,75	0,90	1,05	1,20	1,40	1,60	1,80	2,05	2,30	2,60	2,90	3,20	3,65	4,50	5,40	6,30	7,25	8,15	9,10	10,00	10,95
			D=7	0,75	0,90	1,00	1,20	1,40	1,60	1,80	2,00	2,30	2,55	2,80	3,10	3,45	4,00	4,85	5,75	6,65	7,55	8,45	9,40	10,30
			D=8	0,70	0,85	1,00	1,20	1,40	1,55	1,80	2,00	2,25	2,50	2,80	3,00	3,40	3,75	4,40	5,25	6,10	7,00	7,90	8,80	9,70
			D=9	0,70	0,85	1,00	1,20	1,35	1,55	1,75	2,00	2,20	2,50	2,80	3,00	3,30	3,70	4,10	4,80	5,65	6,50	7,35	8,25	9,10
			D=10	0,70	0,85	1,00	1,15	1,35	1,50	1,70	1,95	2,20	2,45	2,70	3,00	3,30	3,60	4,00	4,40	5,20	6,00	6,85	7,70	8,60
			D=11	0,70	0,85	1,00	1,15	1,35	1,50	1,70	1,90	2,15	2,40	2,70	3,00	3,20	3,55	3,90	4,30	4,80	5,60	6,40	7,25	8,10
			D=12	0,70	0,85	0,95	1,15	1,30	1,50	1,70	1,90	2,10	2,35	2,65	2,90	3,20	3,50	3,85	4,20	4,60	5,25	6,00	6,80	7,60
			D=13	0,70	0,85	0,95	1,10	1,30	1,50	1,65	1,90	2,10	2,30	2,60	2,85	3,10	3,45	3,80	4,15	4,50	5,00	6,56	6,40	7,20
			D=14	0,65	0,80	0,90	1,10	1,25	1,40	1,65	1,85	2,05	2,30	2,55	2,80	3,10	3,40	3,70	4,10	4,40	4,85	5,40	6,10	6,80
			D=15	0,65	0,80	0,90	1,10	1,25	1,40	1,65	1,80	2,05	2,30	2,50	2,80	3,05	3,35	3,65	4,00	4,35	4,75	5,20	5,80	6,50

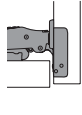
C10 Ø26		 95°	L	T=12	T=13	T=14	T=15	T=16	T=17	T=18	T=19	T=20	T=21	T=22
			D=3	0,25	0,45	0,65	0,95	1,40	2,00	2,75	3,60	4,45	5,30	6,25
			D=4	0,25	0,40	0,65	0,90	1,25	1,75	2,40	3,15	4,00	4,80	5,70
			D=5	0,25	0,40	0,60	0,85	1,20	1,60	2,15	2,80	3,55	4,35	5,20
			D=6	0,20	0,40	0,55	0,80	1,10	1,50	2,00	2,55	3,25	4,00	4,75
D=7	0,20	0,35	0,55	0,75	1,02	1,40	1,85	2,35	2,95	3,65	4,40			