

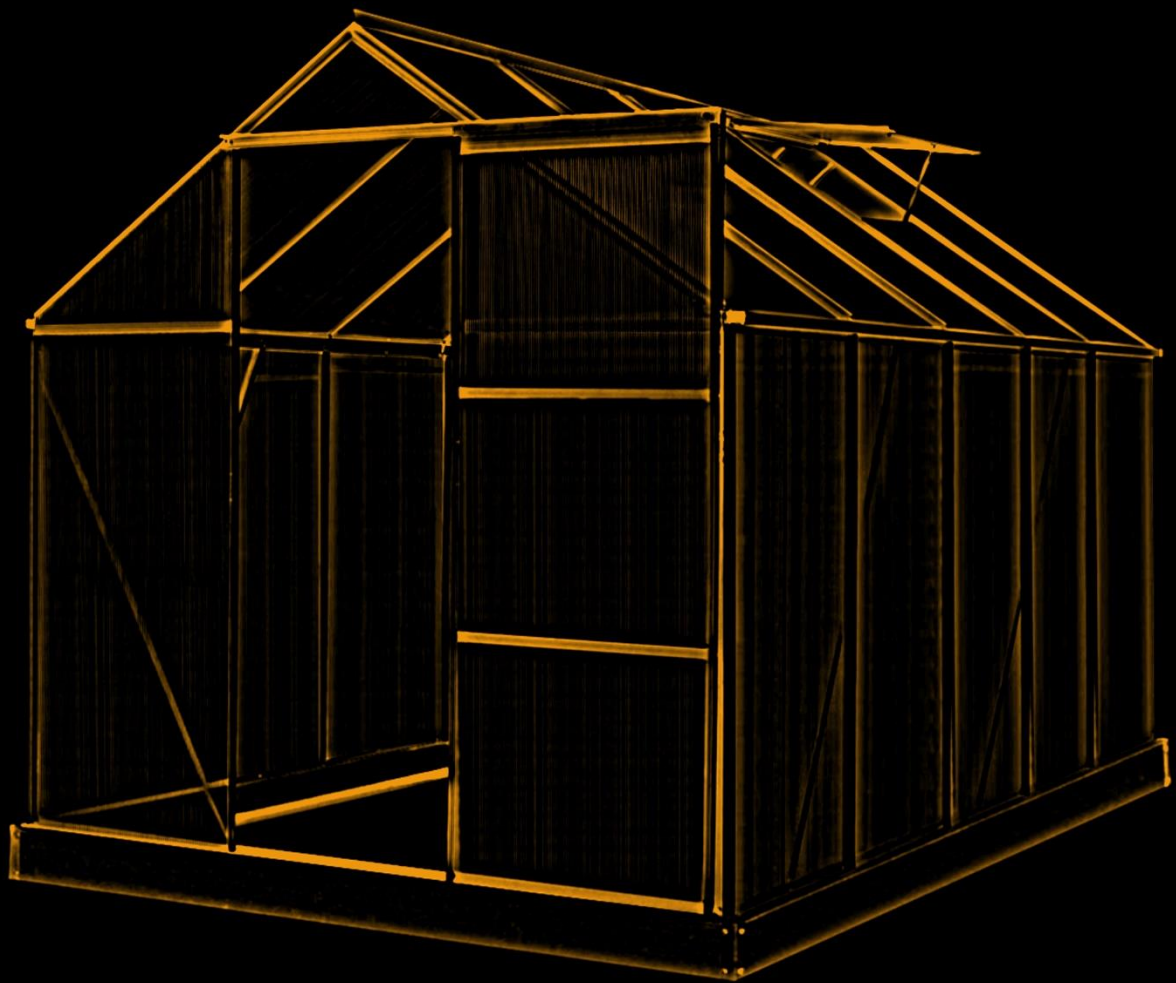

Notice de montage

Serre de jardin

FX-GWH159



Attention : avant de commencer à travailler, veuillez lire attentivement le manuel d'utilisation, car il contient toutes les informations importantes et les consignes de sécurité dont le respect est une condition préalable à l'utilisation correcte de cet appareil.

FUXTEC GmbH
KAPPSTR.69 , 71083 HERRENBERG - GÜLTSTEIN , GERMANY

Sommaire

Introduction et sécurité.....	3
Utilisation conforme.....	3
Contenu	4
Montage	6
Montage des fondations	6
Préparation	7
Montage des parois latérales.....	8
Montage de la paroi extérieure avant.....	10
Assemblage des différents éléments	11
Montage de la porte coulissante.....	12
Montage de la fenêtre.....	13
Montage des éléments de stabilisation	15
Assemblage de la serre avec les fondations.....	16

Introduction et sécurité

Chère cliente, cher client !

Nous vous remercions d'avoir acheté notre serre. Nous vous souhaitons beaucoup de plaisir et une récolte abondante.

Pour votre propre sécurité, veuillez tenir compte des points suivants lors du montage :

- Familiarisez-vous avec ces instructions avant de commencer le travail.
- Portez un équipement de protection (par ex. des gants de travail solides), sinon vous risquez de vous blesser avec des arêtes vives ou d'autres éléments lors du montage.
- Effectuer le montage avec au moins deux personnes.
- Nous vous recommandons d'ancrer solidement la serre.
- Fermez le plus rapidement possible toutes les ouvertures de la serre lorsque le vent se lève.
- En cas de chute de neige, dégagez rapidement la neige du toit avant qu'un poids trop important ne provoque des dommages.

Utilisation conforme





















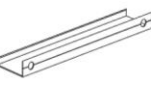

























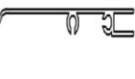

La serre est destinée à la culture de plantes et ne doit être utilisée qu'à cette fin.

Format des instructions de montage

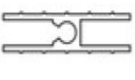







Les instructions de montage utilisent principalement des images et des dessins. Nous vous recommandons de procéder à un prémontage des différentes sections, puis d'assembler les éléments entre eux.









Contenu





Les éléments suivants sont inclus dans la livraison :



7			1215mm	4	18			1245mm	1
16-1			1130mm	1	25			396mm	1
16-2				1	14			1824mm	1
16-3				1	12			596mm	2
16-4				1	22			1362mm	4
6			1830mm	1	23				1310mm
5				1	21				632mm
4			1521mm	2	15			602mm	5
4-1				2	W1			590mm	1
26			630mm	4	W2			522mm	2
8			1521mm	2	W3			630mm	1
8-1			2	1521mm	2	D1			1614mm
17			1521mm	2	D4	1			
27			630mm	1	D2			621mm	1
19			1215mm	8	D3				3
20			1113mm	8	10R				
10L	1	9R			1641mm	1			
9L	1	13						635mm	1



Mode d'emploi original FUXTEC Serre de jardin FX-GWH159



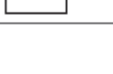

B3	Attaches	176	
B4	Fermeture de fenêtre	1	
B5	Equerre métallique	4	
B6	Equerre métallique	1	
B8	Equerre métallique	1	
W4	Poignée de fenêtre	1	
S3	Couverture de la gouttière	4	
S8	Manchon en plastique	1	

S9.	Douille en plastique	1	
F1	Vis ST3.6x10	10	
F2	Vis M5x20 avec écrou	2	
F3	Vis M5x35 avec écrou	1	
F4	Vis M6x10 avec écrou	148	
F5	Vis M5x10 avec écrou	3	
F8	Vis M4x15 avec écrou	1	
F9	Vis M4x22 avec écrou	1	
F11	Vis T5x15	4	

P8	Panneau 1213x600	15	
P9	Panneau 1127x600mm	9	
P10	Panneau 585x600 mm	1	
P4L	Panneau 432x600mm	2	
P4R	Panneau 432x600mm	2	

P6	Panneau 650x600mm	1	
P7	Panneau 234x623mm	1	
P2	Panneau 547x593mm	1	
P1	Panneau 518x620mm	3	

T1 8x	
T2 4x	
	24

Pièce	Nr.	qté
	1	2
	2	2
	2-1	2
	3	4
	F4	24
	B2	20

Montage

Montage des fondations

Pièce	Nr.	Qté
	1	2
	2	2
	2-1	2
	3	4
	F4	24
	B2	20

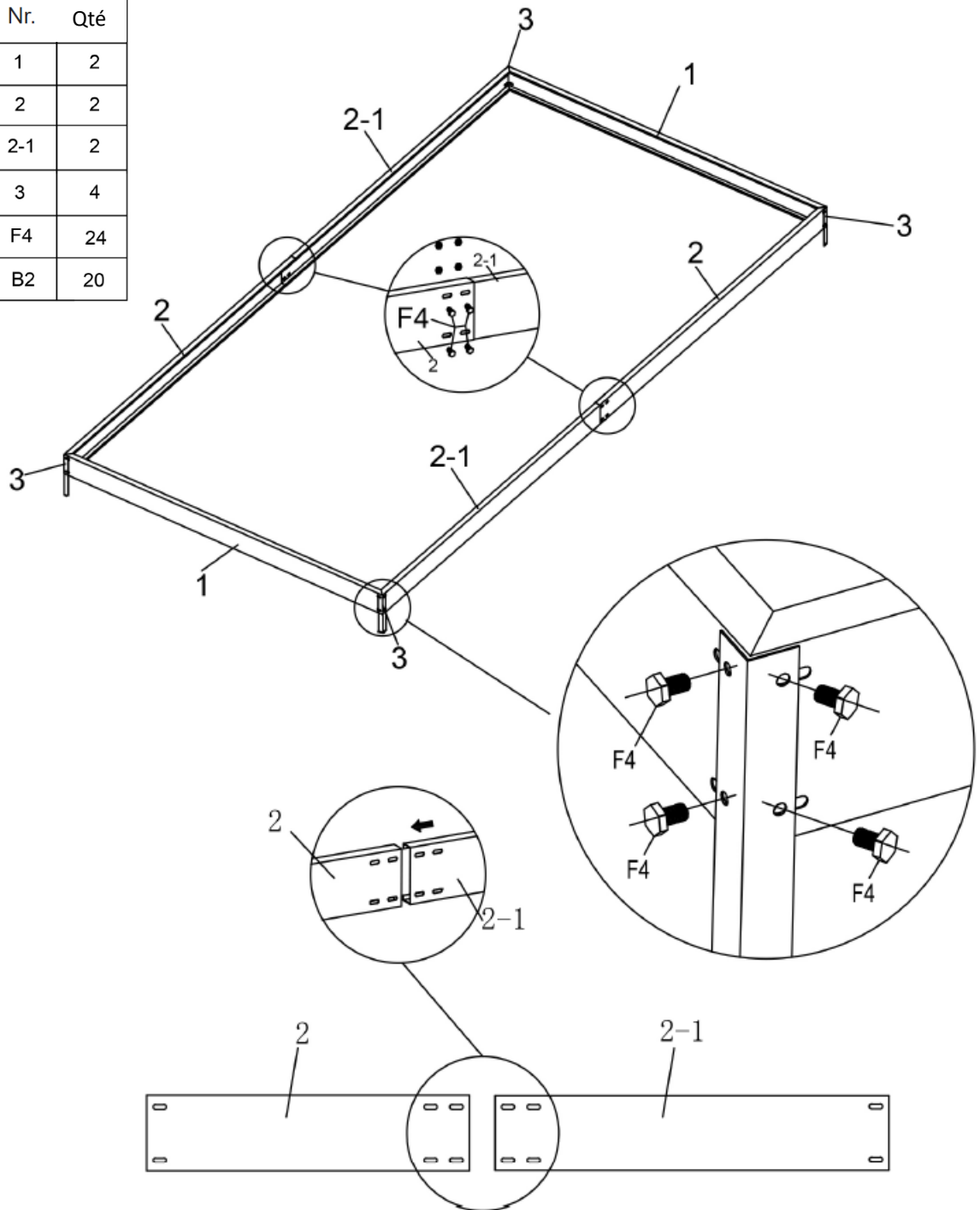



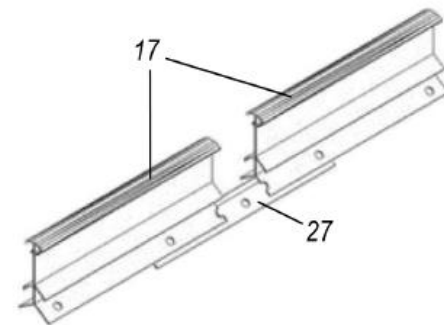
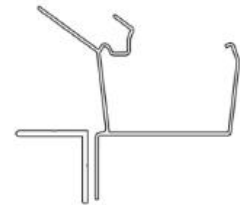
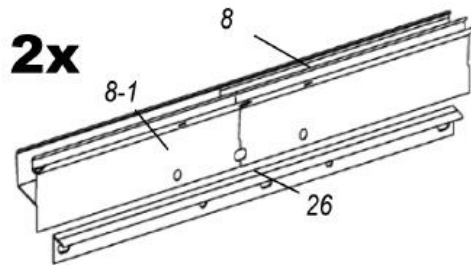
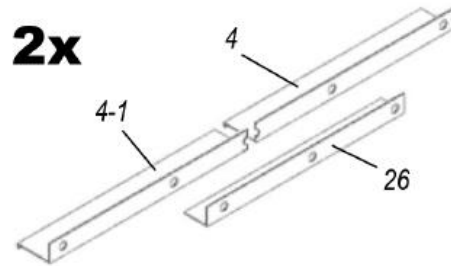

Préparation

4 2x	
4-1 2x	
8 2x	
8-1 2x	
26 4x	
17 2x	
27 1x	
F4	



Montage des parois latérales

4	2x	
8	2x	
19	8x	
22	4x	
F4	28x	

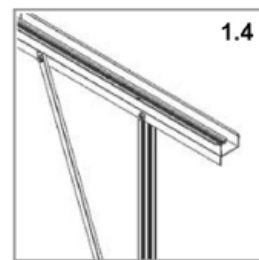
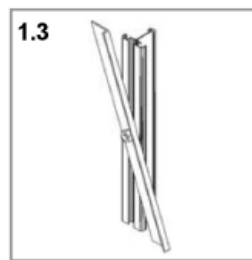
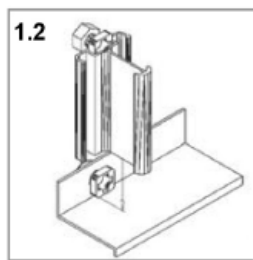
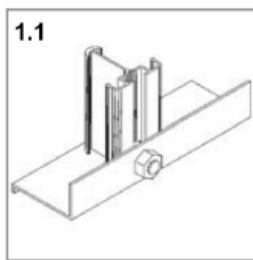
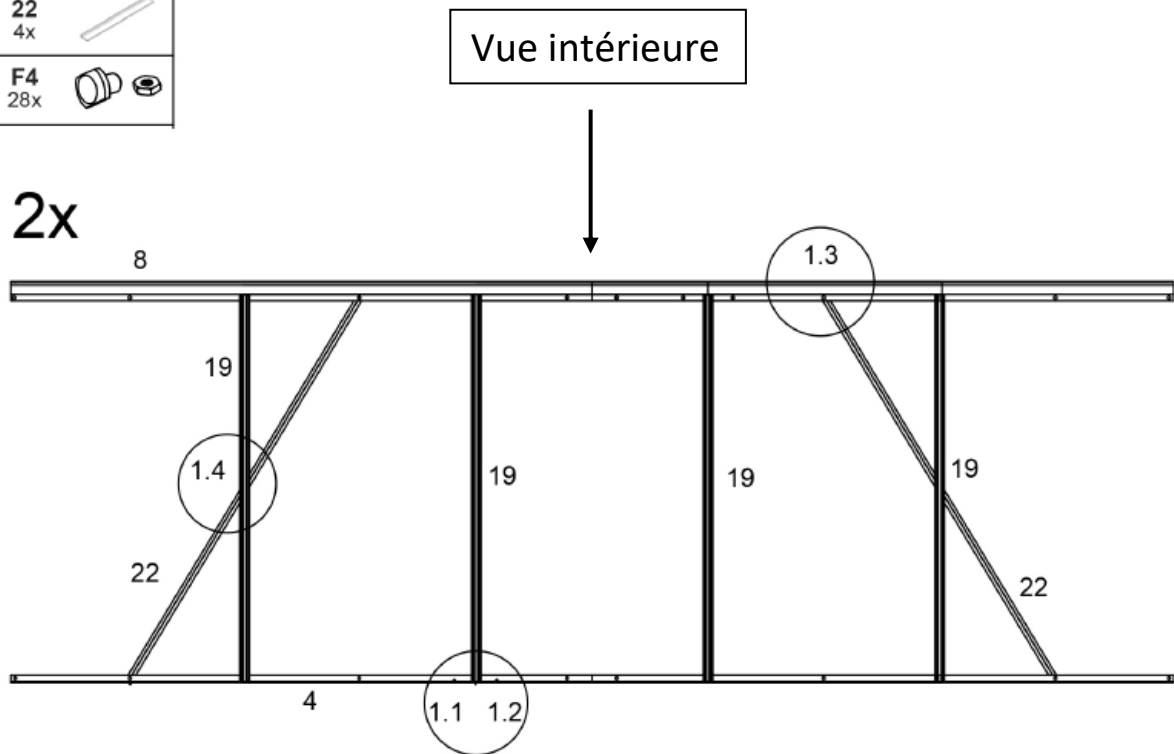

Vue intérieure

Vue extérieure



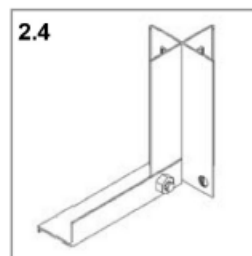
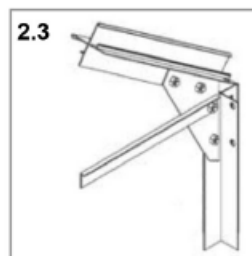
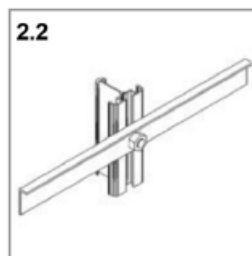
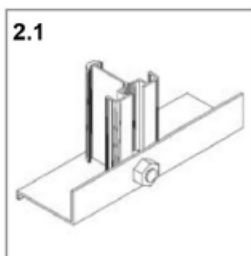
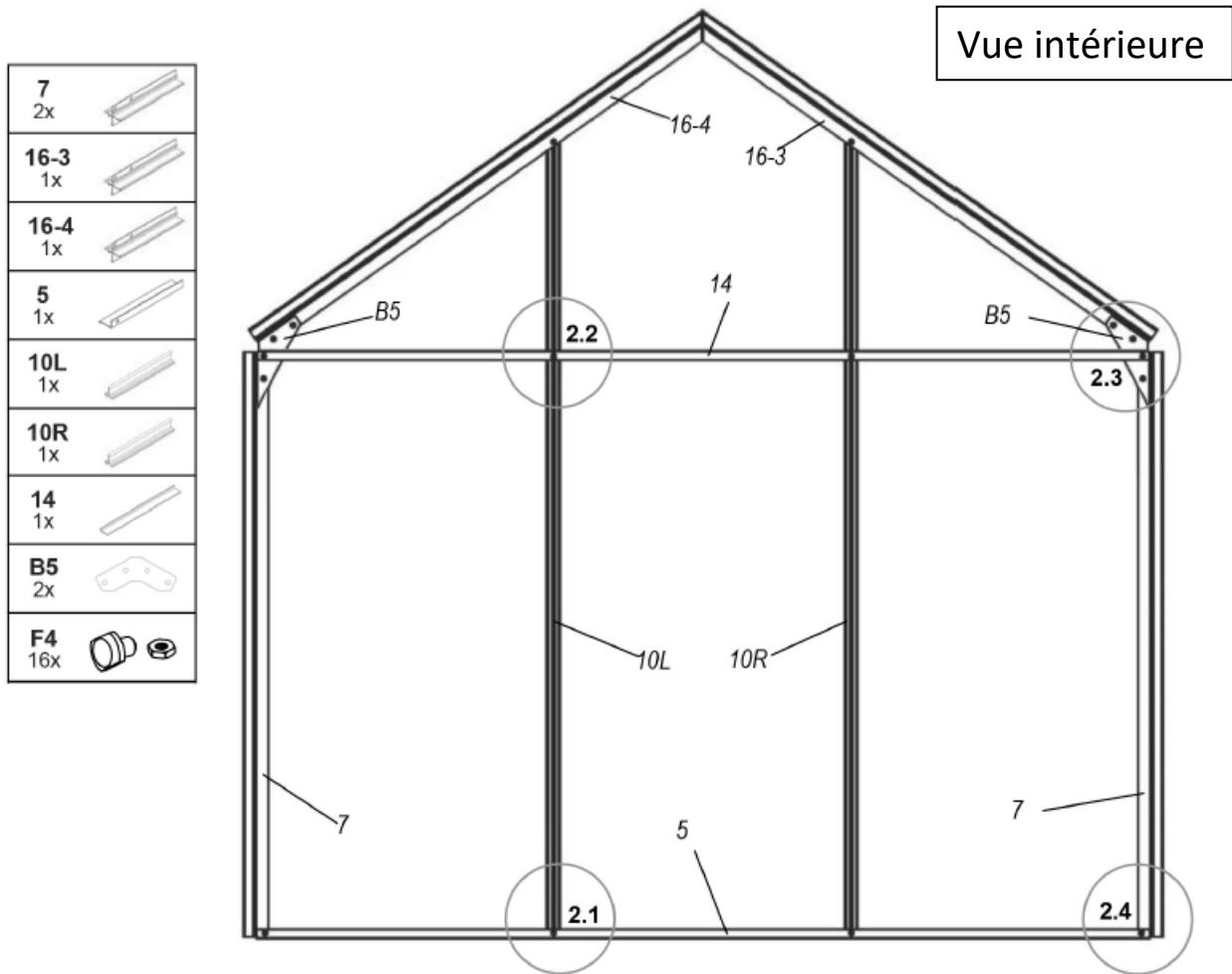



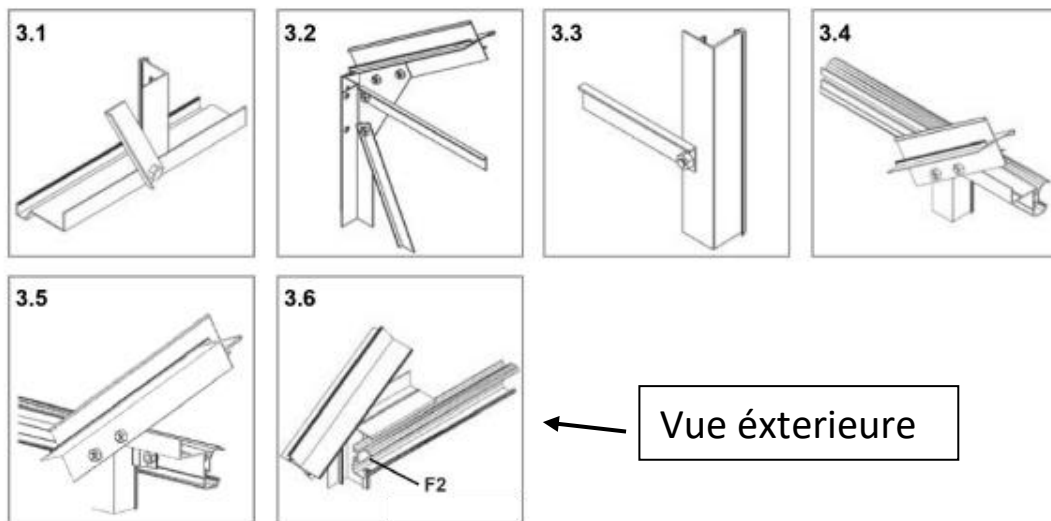
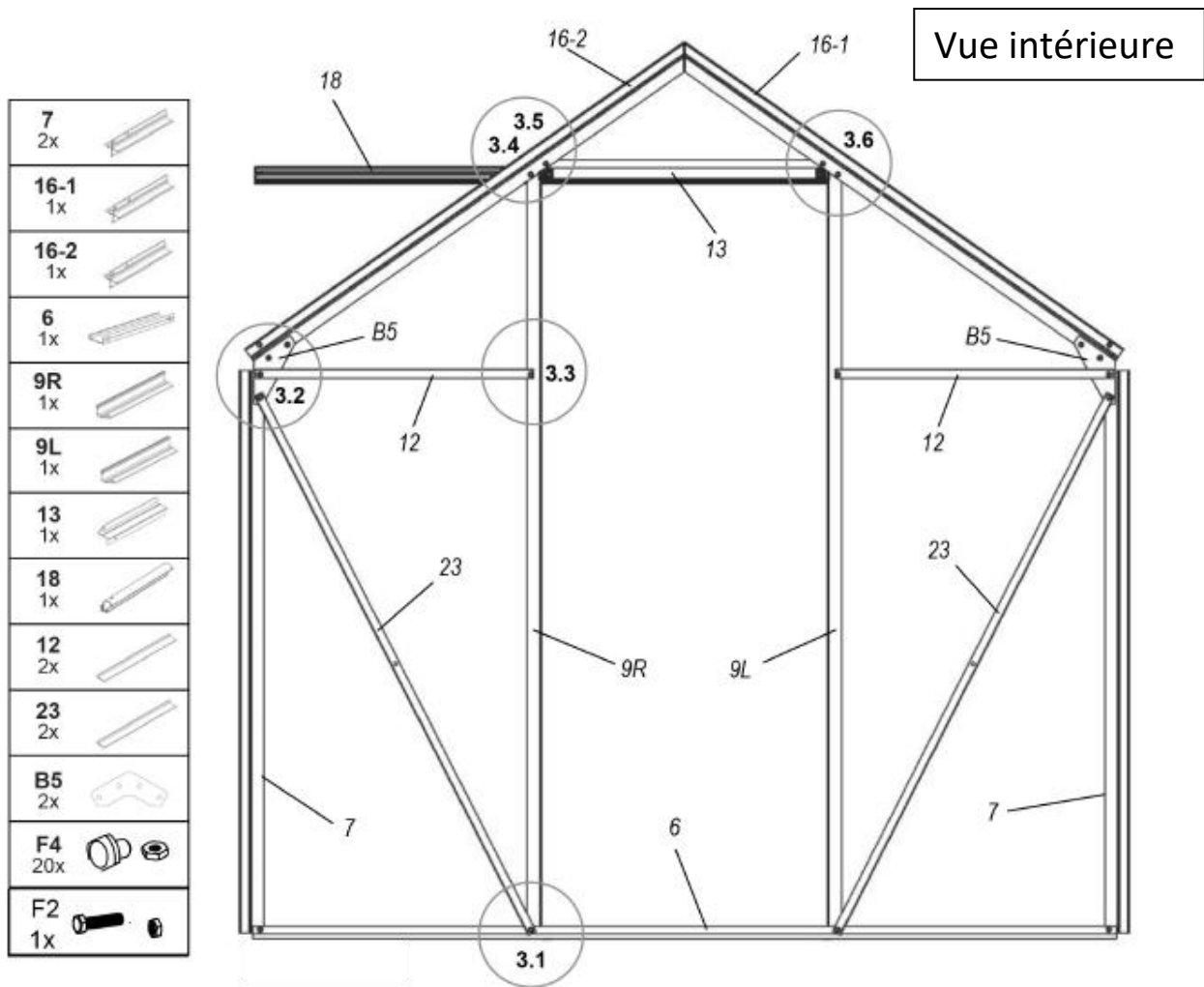

Montage de la paroi extérieur arrière



Montage de la paroi extérieure avant







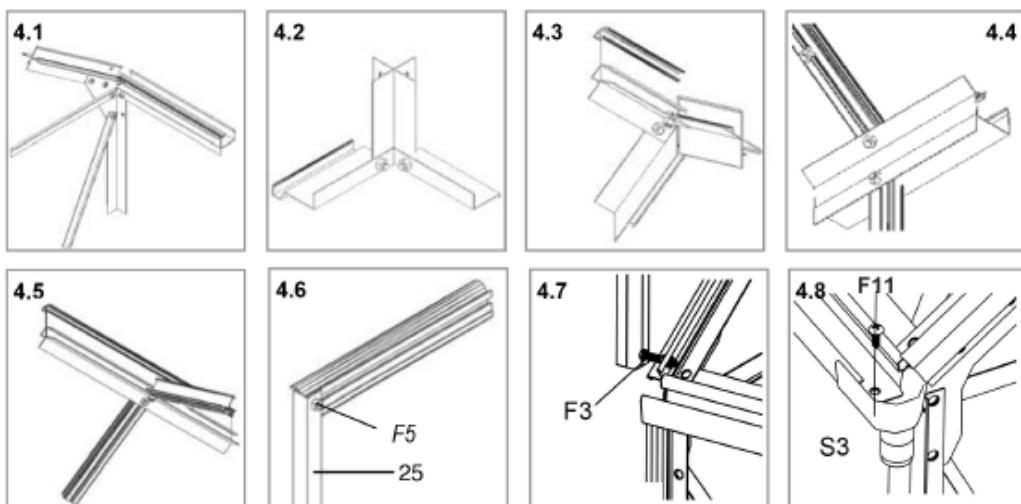
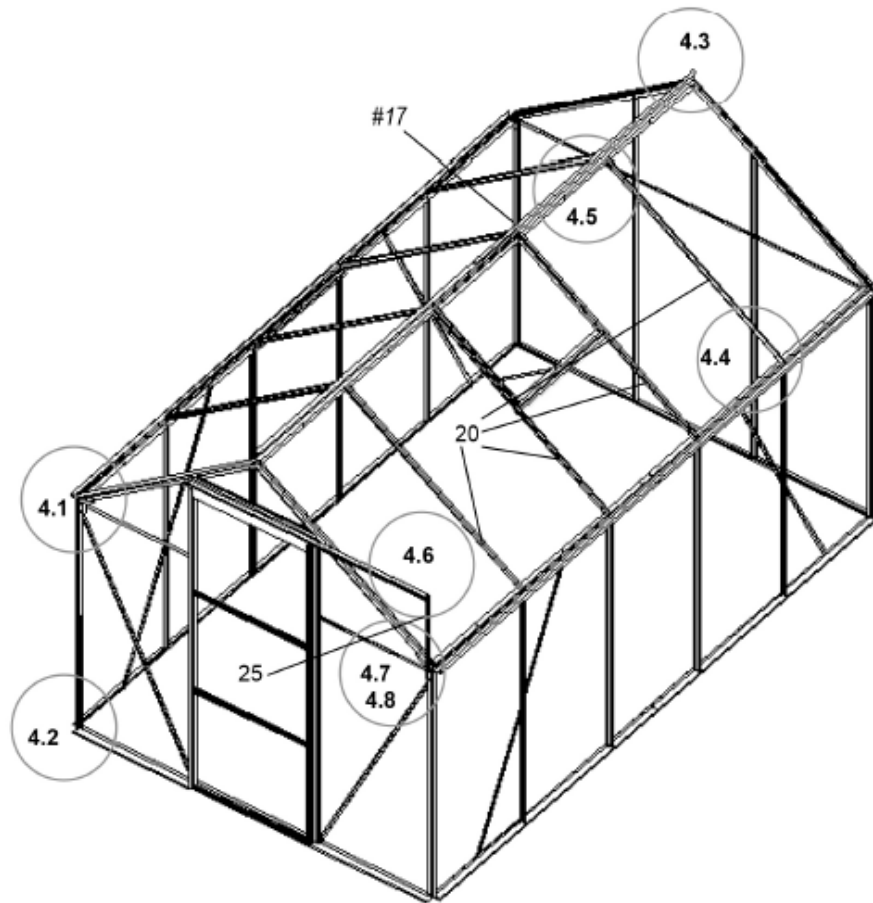

Assemblage des différents éléments

17	1x	
20	8x	
25	1x	
F3	1x	
F4	26x	
F5	1x	
S3	4x	
F11	4x	



← ↑
 Vue extérieure

Montage de la porte coulissante

D1 1x	
D4 1x	
D2 1x	
D3 3x	
F1 10x	
F5 2x	
P1 3x	

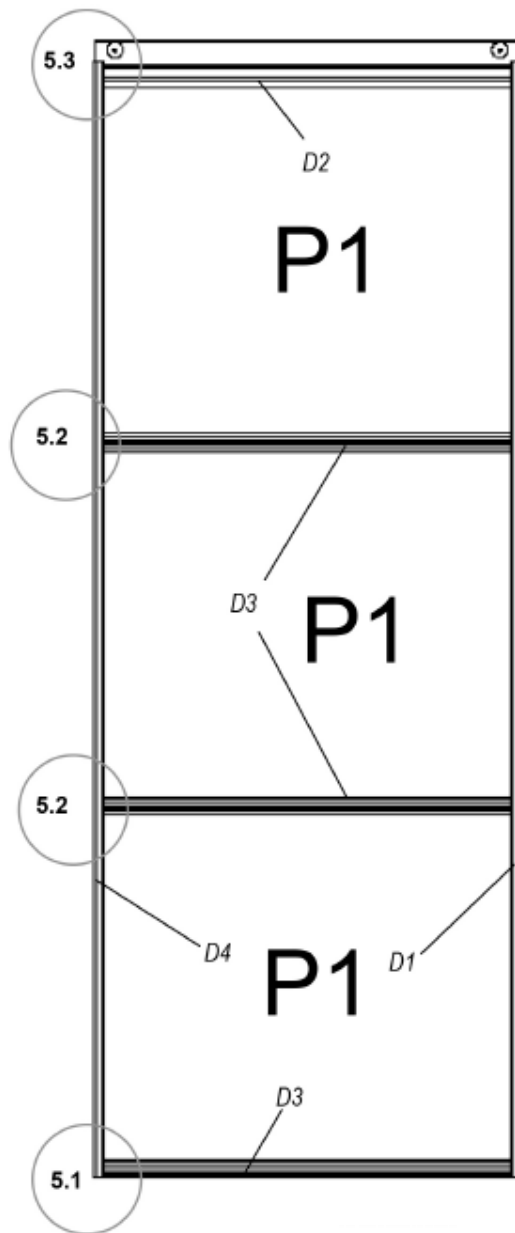

Vue intérieure

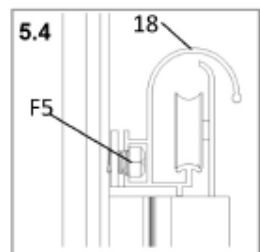
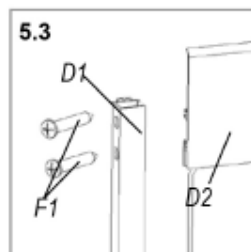
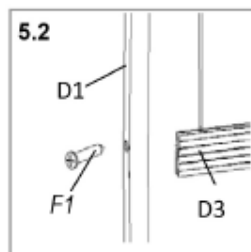
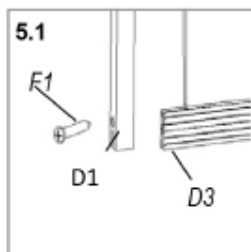

Montage de la fenêtre

21	1x	
W1	1x	
W2	2x	
W3	1x	
B4	1x	
F4	8x	
F2	2x	
W4	1x	
P2	1x	
B8	1x	
F8	1x	
F9	1x	
S8	1x	
S9	1x	

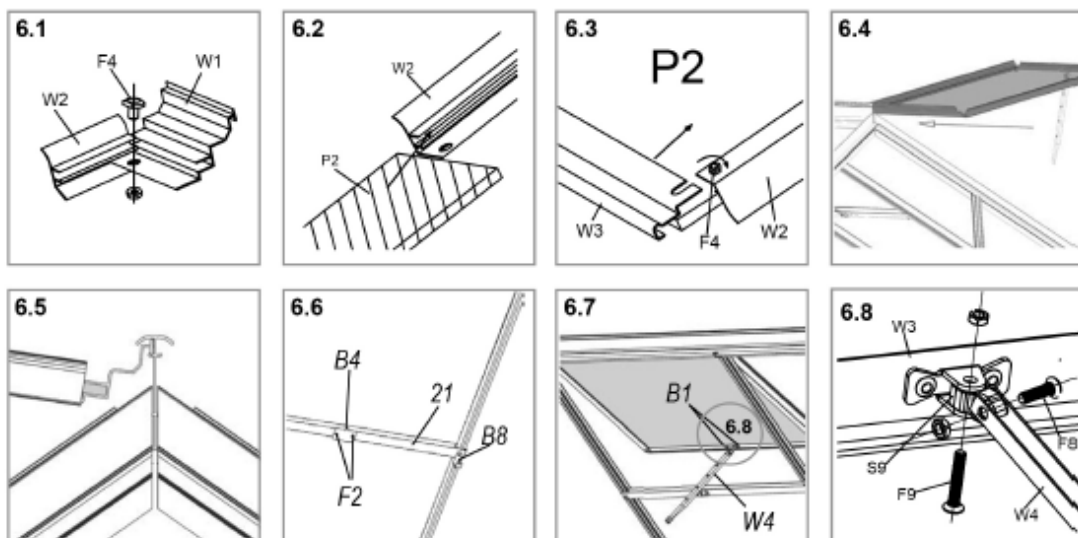
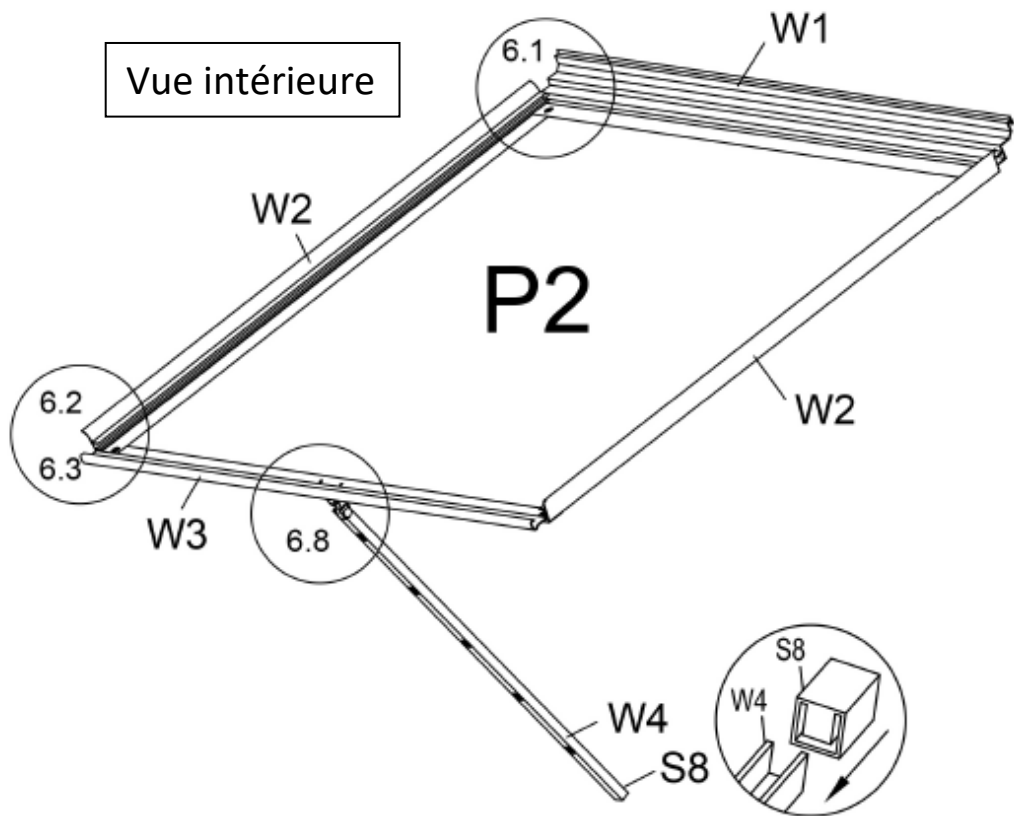

Montage des plaques alvéolées

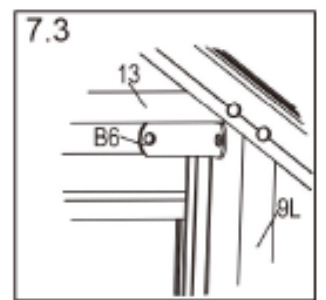
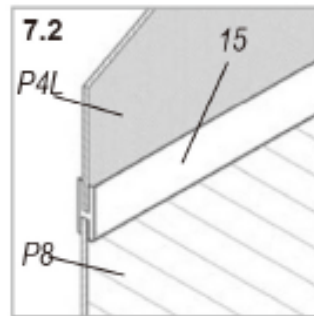
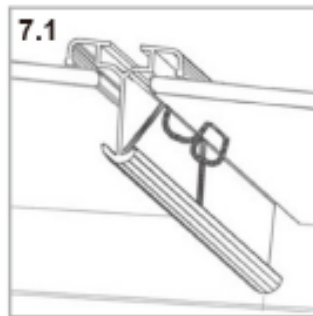
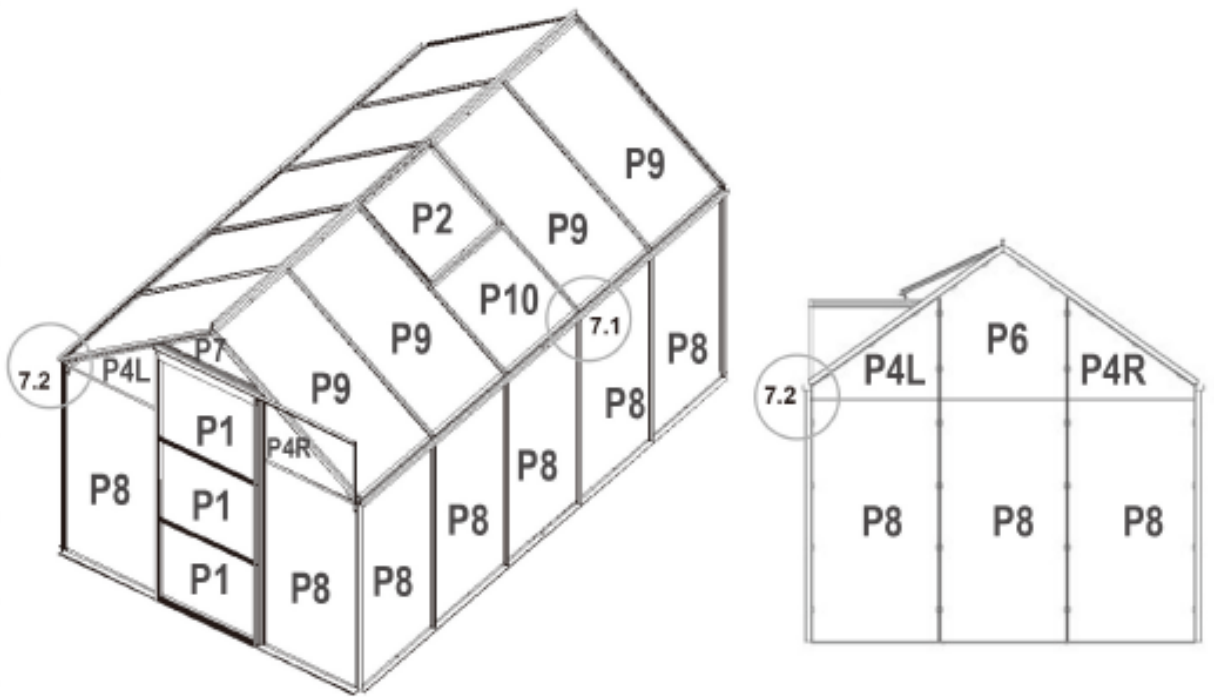
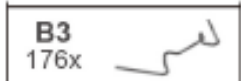

Montage des éléments de stabilisation

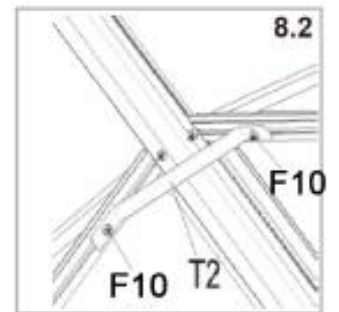
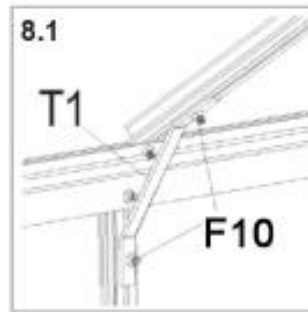
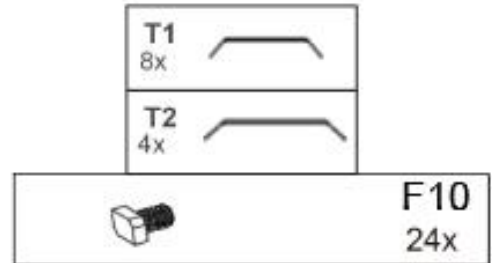
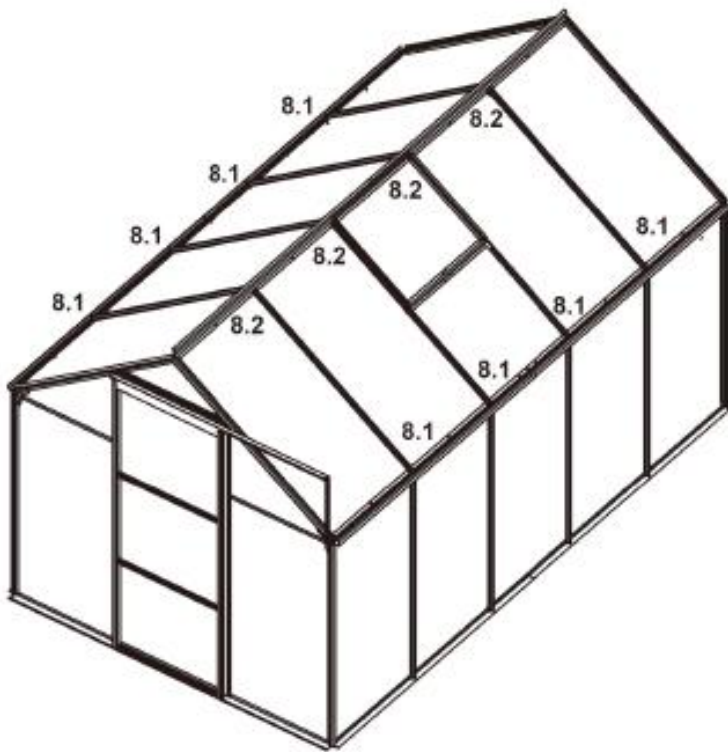

Assemblage de la serre avec les fondations

Pièce	Nr.	qté
	B2	20

