

Heizkörper Montageanleitung

- Lesen Sie die Anleitung vor der Installation sorgfältig durch.
- Die Installation sollte von einer entsprechend qualifizierten Person durchgeführt werden.
- Entsorgen Sie die Verpackung auf verantwortungsvolle Weise

Werkzeuge		Zubehöre	
	Kreuzschraubendreher		Messingrohr mit Endkappen 2X
	Flacher Schraubendreher		
	Bleistift		
	PTFE-Dichtband		
	Maßband		
	Schlüssel		
	8.0mm Bohrer		
	Elektrische Bohrmaschine		

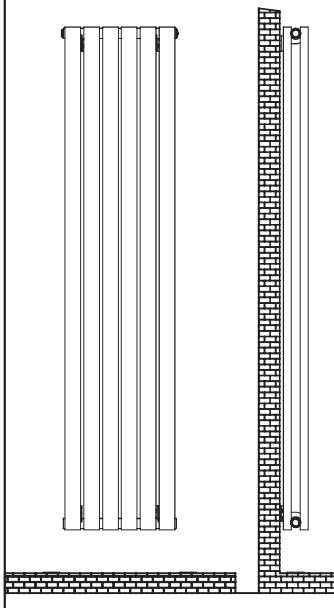

Ersatzteile			
Pos.	Abbildung	Beschreibung	Anzahl
1		Blindstopfen	3
2		Luftventil	1
3		Schrauben Dübel	8
4		Lange Schrauben	8
5		Halterung	4
6		unterleg schein	4

Das Zubehör Nr. 1 (Blindstopfen) und Nr. 2 (Luftventil) sind bereits am Heizkörper vorinstalliert. Bitte passen Sie es während der Installation entsprechend an.

A

1. Installieren Sie 1 (Blindstopfen) und 2 (Luftventil) in der richtigen Position. (Abbildung I)

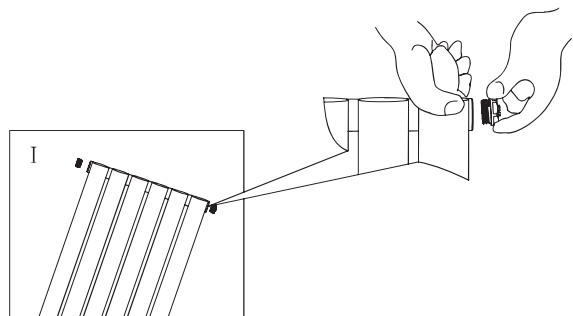

B

1. Wählen Sie eine geeignete Position und markieren Sie die Befestigungspunkte mit einem Bleistift.

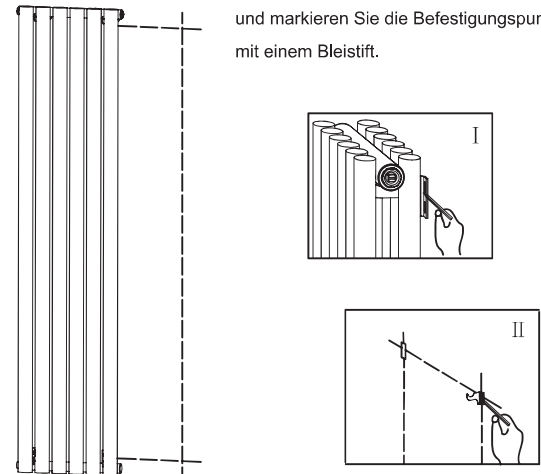

C

- Bohren Sie an der markierten Stelle ein Loch mit einer 8-mm-Bohrmaschine (Abbildung I).
- Setzen Sie 3 (Dübel) in das 8-mm-Loch ein. (Abbildung II).
- Schrauben Sie 4 (lange Schraube) durch 6 (Unterlegscheibe) und 5 (Halterungen) und ziehen Sie sie in 3 (Dübel) fest. (Abbildung III)

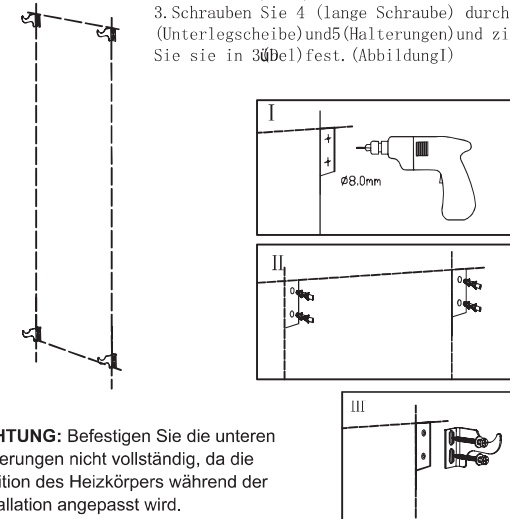

ACHTUNG: Befestigen Sie die unteren Halterungen nicht vollständig, da die Position des Heizkörpers während der Installation angepasst wird.

D

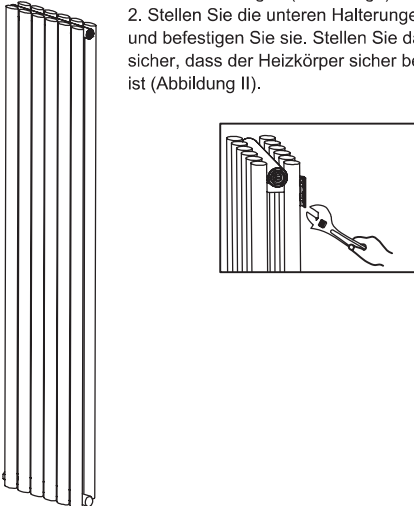

1. Befestigen Sie den Heizkörper an den oberen Halterungen (Abbildung I).
2. Stellen Sie die unteren Halterungen ein und befestigen Sie sie. Stellen Sie dann sicher, dass der Heizkörper sicher befestigt ist (Abbildung II).

E

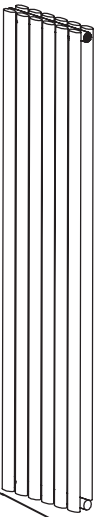

1. Schließen Sie die Ventile und die Leitung vom Warmwasser an. Überprüfen Sie jede Verbindungsstelle und stellen Sie sicher, dass alle Teile korrekt befestigt sind.

F

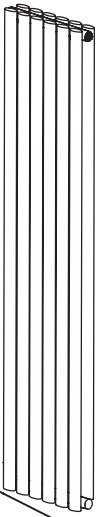

1. Öffnen Sie nach der Installation das Ventil vom Warmwasser, um warmes Wasser einzufüllen.

ACHTUNG: Die Luft im Inneren sollte beim Öffnen des Warmwasserventils durch eine Entlüftung abgelassen werden.

Nach der Installation:

- Öffnen Sie mit einem Schraubendreher das Luftventil, öffnen Sie das Ventil und lassen Sie das Wasser in den Heizkörper strömen. Überprüfen Sie alle Anschlüsse, ob sie dicht sind.
- Sobald Wasser aus dem Luftventil überläuft, befindet sich keine Luft mehr in den Röhren.
- Mit einem Schraubendreher das Luftventil schließen, das Ventil einschalten und der Heizkörper ist jetzt betriebsbereit.

Pflege:

- Klassische Heizkörper bestehen aus verchromtem Stahl und sollten nicht mit ätzenden oder scheuernden Reinigungsmitteln gereinigt werden.

Bitte beachten Sie ...

- Dieses Produkt kann nur bei PN $\leq 1\text{MPa}$ (10 g / cm², 10 Bar) verwendet werden. Es sollte nur mit Wasser gefüllt werden und bei einer Temperatur unter 100 ° C (212 ° F). In der folgenden Tabelle finden Sie die Installationsanforderungen.
- Wenn die Temperatur 48 ° C (oder 120 ° F) überschreitet, zeigen Sie bitte ein Warnschild in der Nähe des Produkts, um Verbrennungen und Schelteinwirkungen zu vermeiden.

Füllen Sie 3/4 voll	Druck	Temperatur	Bemerkungen
Nur Wasser	PN $\leq 1\text{Mpa}$	0° C < t ≤ 100 ° C	Wenn die Umgebungstemperatur unter 1 ° C fällt, lassen Sie das Wasser ab, um ein Einfrieren zu verhindern.



Radiator installation instructions

- Read the instructions carefully before installation.
- Installation should be carried out by a suitably qualified person.
- Dispose of the packaging responsibly

Tools

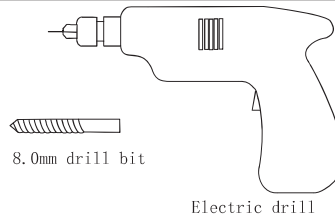
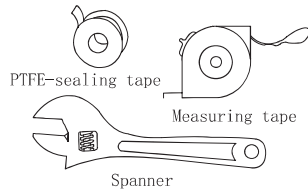
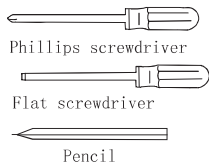

Accessories

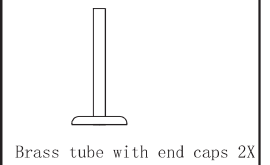

Spare parts

Item	Illustration	Description	Quantity
1		Dummy plug	3
2		Air valve	1
3		Screws Dowels	8
4		Long screws	8
5		Bracket	4
6		Washers	4

The accessories No.1 (blind plug) and No.2 (air valve) are already pre-installed on the heater body. Please adjust them accordingly during installation.

A

1. Install 1 (blind plug) and 2 (air valve) in the correct position. (Figure I)

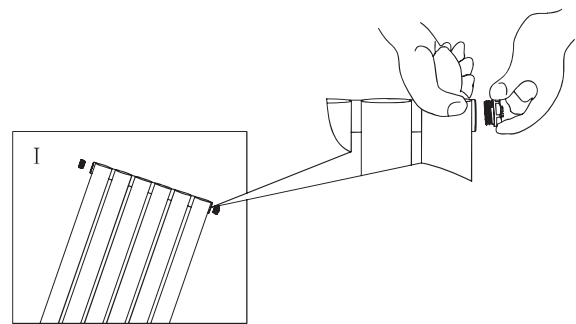

B

1. Choose a suitable position and mark the fixing points with a pencil.

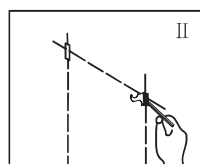
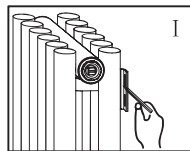
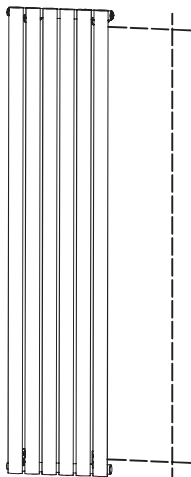

C

1. Drill a hole at the marked location using an 8 mm drill (Figure I).
2. Insert 3 (dowels) into the 8 mm hole. (Figure II).
3. screw 4 (long screw) through 6 (washer) and 5 (brackets) and tighten in 3 (dowel). (Figure I).

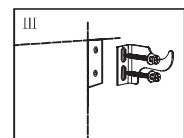
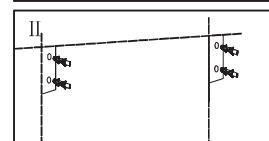
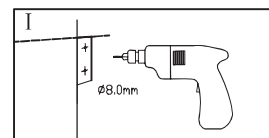
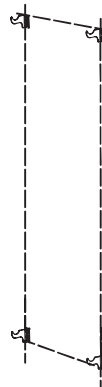

CAUTION: Do not fully fix the bottom brackets as the position of the radiator will be adjusted during installation.

D

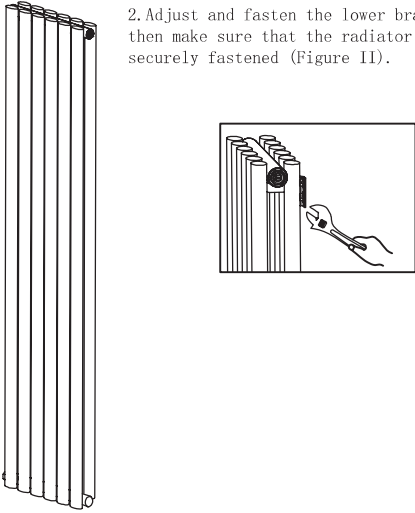

1. Fix the radiator to the upper brackets (Figure I).
2. Adjust and fasten the lower brackets, then make sure that the radiator is securely fastened (Figure II).

E

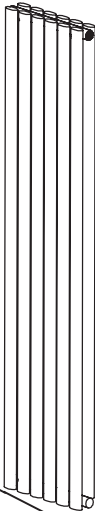

1. Connect the valves and the pipe from the hot water. Check each connection point and make sure that all parts are correctly fastened.

F

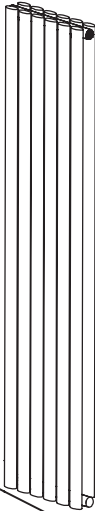

1. After installation, open the valve from the hot water to fill hot water.

ATTENTION: The air inside should be released by venting when opening the hot water valve.

After installation:

- Open the air valve with a screwdriver, open the valve and let the water flow into the radiator. Check that all connections are tight.
- Once water overflows from the air valve, there is no more air in the tubes.
- Use a screwdriver to close the air valve, turn on the valve and the radiator is now ready for use.

Maintenance:

- Classic radiators are made of chrome-plated steel and should not be cleaned with corrosive or abrasive cleaning agents.

Please note







- This product can only be used at PN $\leq 1\text{MPa}$ (10g/cm², 10 Bar) It should only be filled with water and at a temperature below 100° C (212° F). Refer to the following table for installation requirements.
- If the temperature exceeds 48° C (or 120° F), please display a warning sign near the product to prevent burns and exposure to radiation.

Fill 3/4 full	Pressure	Temperature	Remarks
Water only	PN $\leq 1\text{Mpa}$	0°C < t $\leq 100^\circ\text{C}$	If the ambient temperature drops below 1° C, drain the water to prevent freezing.

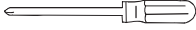

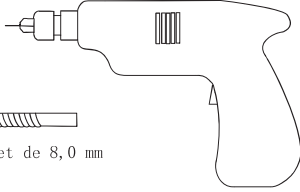

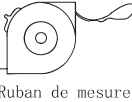
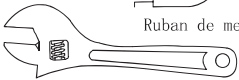

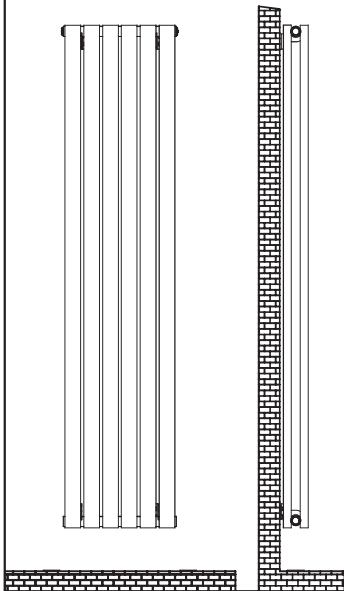

Instructions d'installation du radiateur

- Lisez attentivement les instructions avant l'installation.
- L'installation ~~être~~ effectuée par une personne ~~ûment~~ qualifiée.
- Jetez l'emballage de manière responsable

Outils	Accessoires
 Tournevis Phillips  Tournevis plat  Crayon	 Perceuse électrique  Foret de 8,0 mm  Ruban d'étanchéité en PTFE  Ruban de mesure  Clé à molette  Tube en laiton avec embouts 2X



Pièces détachées

Article	Illustration	Description	Quantité
1		Bouchon factice	3
2		Valve d'air	1
3		Vis Chevilles	8
4		Vis longues	8
5		Support	4
6		Rondelles	4

Les accessoires No.1 (bouchon) et No.2 (vanne d'air) sont à pré-installer sur le corps du réchauffeur, veuillez les ajuster en conséquence pendant l'installation.

A

1. Installez 1 (bouchon borgne) et 2 (vanne d'air) dans la bonne position. (Figure I)

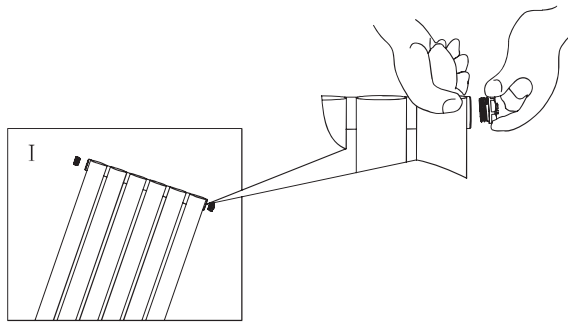

B

1. Choisissez une position appropriée et marquez les points de fixation avec un crayon.

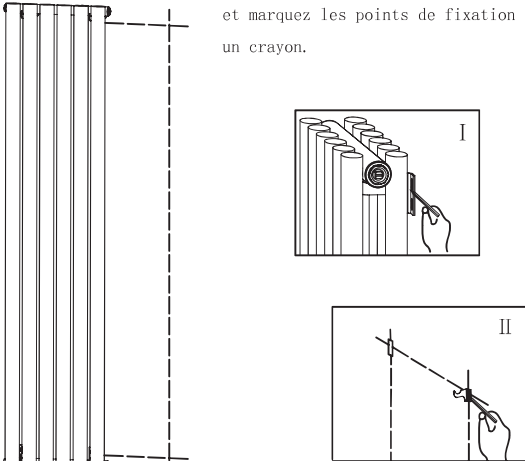

C

1. Percez un trou à l'endroit marqué à l'aide d'un foret de 8 mm (figure I).
 2. Insérez 3 (chevilles) dans le trou de 8 mm (Figure II).
 3. Vissez 4 (vis longue) travers 6 (rondelle) et 5 (supports) et serrez dans 3 (cheville). (Figure I).

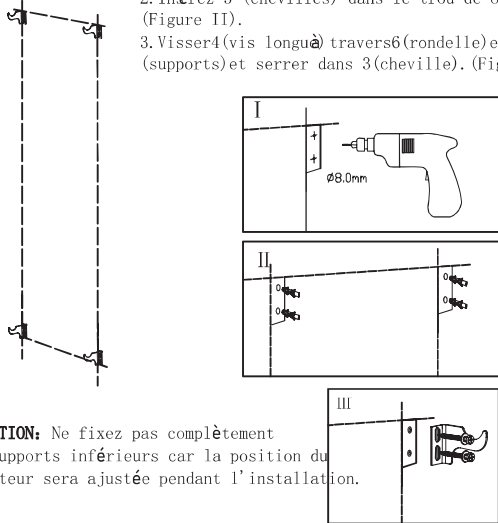

ATTENTION: Ne fixez pas complètement les supports inférieurs car la position du radiateur sera ajustée pendant l'installation.

D

1. Fixez le radiateur aux supports supérieurs (Figure I).
 2. Ajustez et fixez les supports inférieurs, puis assurez-vous que le radiateur est bien fixé (Figure II).

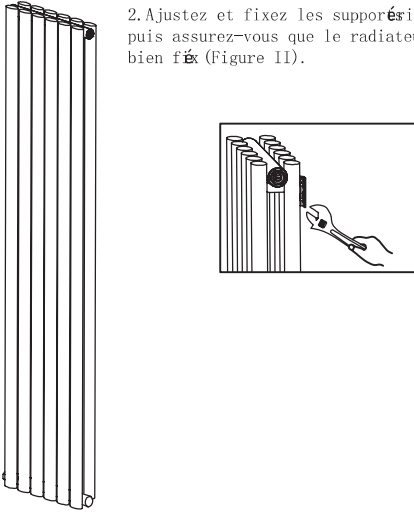

E

1. raccordez les vannes et la conduite d'eau chaude. Vérifier chaque point de raccordement et s'assurer que toutes les pièces sont correctement fixées.

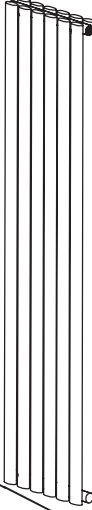

F

1. Après l'installation, ouvrez la vanne de l'eau chaude pour remplir l'eau chaude.

ATTENTION: L'air à l'intérieur doit être libéré par ventilation lors de l'ouverture de la vanne d'eau chaude.

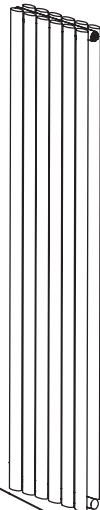

Après l'installation:

- Ouvrez la vanne d'air à l'aide d'un tournevis, ouvrez la vanne et faites couler l'eau dans le radiateur. Vérifiez que tous les raccords étanches.
- Dès que l'eau déborde de la vanne d'air, il n'y a plus d'air dans les tubes.
- Fermez la vanne d'air à l'aide d'un tournevis, mettez la vanne en marche et le radiateur est prêt à fonctionner.

Entretien:

- Les radiateurs classiques sont en acier émaillé ne doivent pas être nettoyés avec des produits corrosifs ou abrasifs.

Veillez noter

- Ce produit ne peut être utilisé qu'à PN ≤ 1MPa (10g/cm², 10bar) Il ne doit être rempli que d'eau et à une température inférieure à 100° C (212° F). Le tableau suivant indique les exigences d'installation.
- Si la température dépasse 48° C (ou 120° F), veuillez afficher un panneau d'avertissement à proximité du produit pour éviter les brûlures et les effets de la chaleur.

Remplir aux 3/4	Pression	Température	Remarques
Eau seulement	PN ≤ 1MPa	0° C < t ≤ 100° C	Si la température ambiante descend en dessous de 1° C, vidangez l'eau pour éviter le gel.



Instrucciones de instalación del radiador

- Lea atentamente las instrucciones antes de la instalación.
- La instalación debe ser realizada por una persona debidamente calificada.
- Elimine el embalaje de forma responsable.

Herramientas

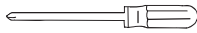

Destornillador de estrella



Destornillador plano



Lápiz



Cinta de sellado de PTFE

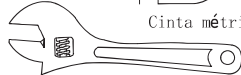

Cinta métrica



Llave inglesa



Broca de 8,0 mm

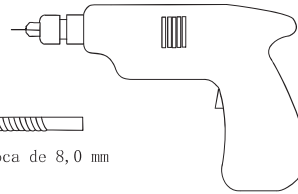

Taladro eléctrico

Accesorios

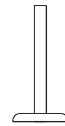

Tubo de laón con tapones 2X

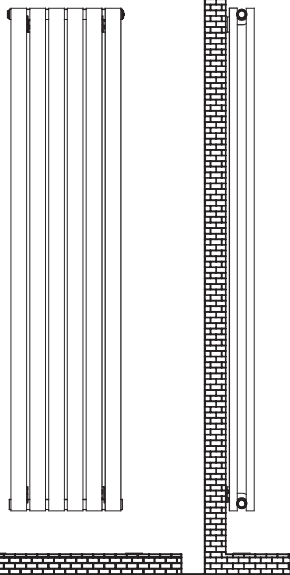

Piezas de recambio

Artículo	Ilustración	Descripción	Cantidad
1		Tapón falso	3
2		Válvula de aire	1
3		Tornillos Tacos	8
4		Tornillos largos	8
5		Soporte	4
6		Arandelas	4

Los accesorios No. 1 (tapón ciego) y No. 2 (válvula de aire) ya están preinstalados en el cuerpo del calentador.

A

1. Instale el (tapón ciego) y (válvula de aire) en la posición correcta. (Figura I)

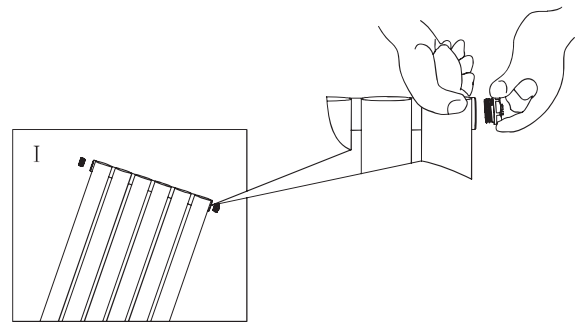

B

1. Elija una posición adecuada y marque los puntos de fijación con un lápiz.

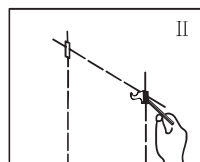
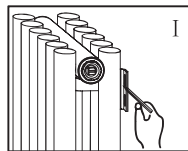
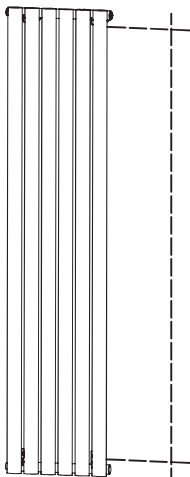

C

1. Haga un agujero en el lugar marcado con una broca de 8 mm (Figura I).
2. Inserte 3 (clavijas) en el agujero de 8 mm. (Figura II).
3. Atornille (tornillo largo) en (arandela) y (soportes) y apriete en (clavija). (Figura III).

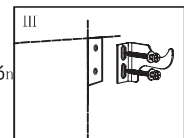
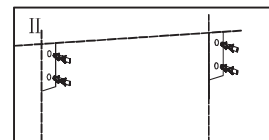
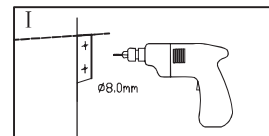
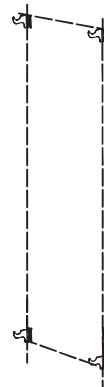

PRECAUCIÓN: No fije completamente los soportes inferiores ya que la posición del radiador se ajustará durante la instalación.

D

1. Fije el radiador a los soportes superiores (Figura D).
 2. Ajuste y fije los soportes inferiores y asegúrese de que el radiador esté bien sujeto (Figura II).

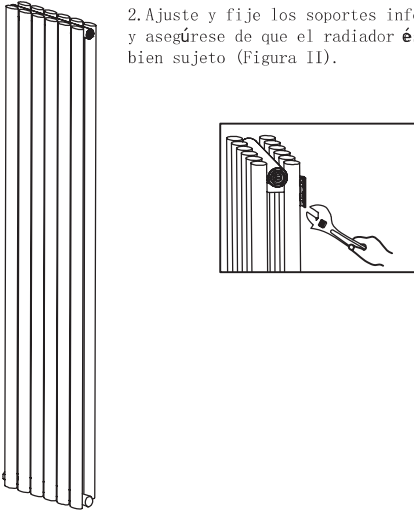

E

1. Conectar las válvulas y la tubería del agua caliente. Compruebe cada punto de conexión y asegúrese de que todas las piezas estén correctamente fijadas.

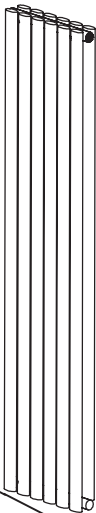

F

1. Después de la instalación abra la válvula del agua caliente para llenar el agua caliente.

ATENCIÓN: Al abrir la válvula del agua caliente, el aire del interior debe salir por la ventilación caliente.

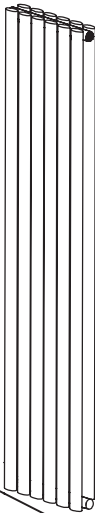

Después de la instalación:

- Abra la válvula de aire con un destornillador, abrávala y deje que el agua fluya hacia el radiador. Compruebe que todas las conexiones estén apretadas.
- Una vez que el agua se desborda de la válvula de aire, no hay más aire en los tubos.
- Utilice un destornillador para cerrar la válvula de aire, encienda la válvula y el radiador ya está listo para su uso.

Mantenimiento:

- Los radiadores clásicos son de acero cromado y no deben limpiarse con productos de limpieza corrosivos o abrasivos.

Tenga en cuenta

- Este producto sólo puede utilizarse con PN $\leq 1\text{MPa}$ (10g/cm², 10 Bar) Sólo debe llenarse con agua y a una temperatura inferior a 100° C (212° F). Consulte la siguiente tabla para conocer los requisitos de instalación.
- Si la temperatura supera los 48° C (o 120° F), coloque un cartel de advertencia cerca del producto para evitar quemaduras y exposición a la radiación.

Llenar 3/4 de su capacidad	Presión	Temperatura	Observaciones
Sólo agua	$\text{PN} \leq 1\text{MPa}$	$0^{\circ}\text{C} < t \leq 100^{\circ}\text{C}$	Si la temperatura ambiente desciende por debajo de 1° C, drene el agua para evitar la congelación.



Istruzioni per l'installazione del radiatore

- Leggere attentamente le istruzioni prima dell'installazione.
- L'installazione deve essere eseguita da una persona adeguatamente qualificata.
- Smaltire l'imballaggio in modo responsabile

Strumenti

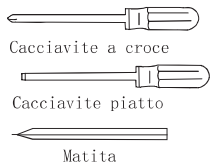

Cacciavite a croce

Cacciavite piatto

Matita

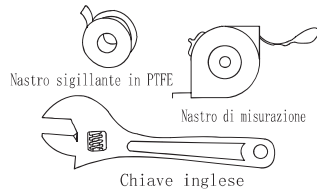

Nastro sigillante in PTFE

Nastro di misurazione

Chiave inglese

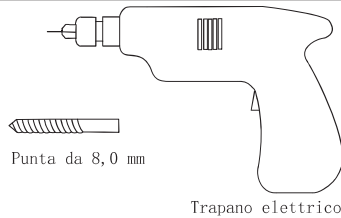

Punta da 8,0 mm

Trapano elettrico

Accessori

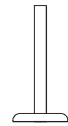

Tubo in ottone con tappi 2X

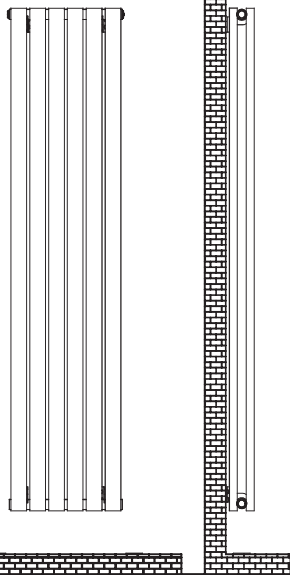

Pezzi di ricambio

Voce	Illustrazione	Descrizione	Quantità
1		Tappo cieco	3
2		Valvola dell'aria 1	1
3		Viti Tasselli	8
4		Viti lunghe	8
5		Staffa	4
6		rondelle	4

Gli accessori n. 1 (tappo cieco) e n. 2 (valvola dell'aria) sono già preinstallati sul corpo del riscaldatore; si prega di regolarli di conseguenza durante l'installazione.

A

1. Installare il (tappo cieco) e 2 (valvola dell'aria) nella posizione corretta. (Figura I)

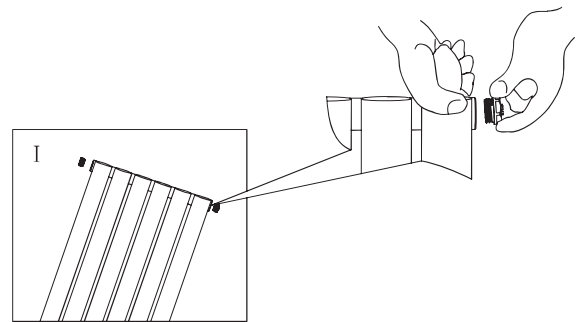

B

1. Scegliere una posizione adatta e segnare i punti di fissaggio con una matita.

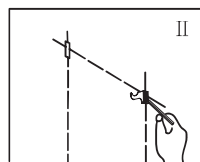
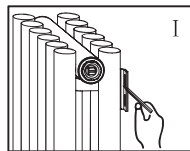
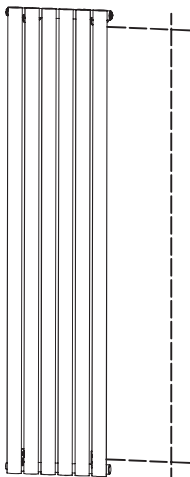

C

1. Praticare un foro nel punto contrassegnato utilizzando una punta da 8 mm (Figura I).
 2. Inserire 3 (tasselli) nel foro da 8 mm. (Figura II).
 3. avvitare 4 (vite lunga) attraverso 6 (rondella) e 5 (staffe) e serrare in 3 (tassello). (Figura I).

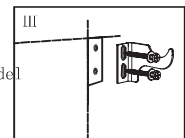
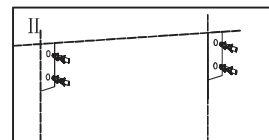
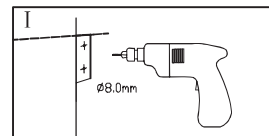

ATTENZIONE: Non fissare completamente le staffe inferiori perché la posizione del radiatore verrà regolata durante l'installazione.

D

1. Fissare il radiatore alle staffe superiori (Figura 1).
 2. Regolare e fissare le staffe inferiori e assicurarsi che il radiatore sia ben saldo (Figura 2).

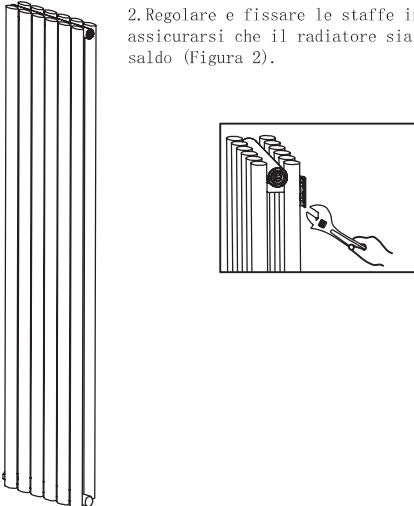

E

1. collegare le valvole e il tubo dell'acqua calda. Controllare ogni punto di collegamento e assicurarsi che tutte le parti siano fissate correttamente.

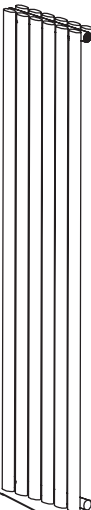

F

1. Dopo l'installazione, aprire la valvola dell'acqua calda per riempire l'acqua calda.

ATTENZIONE: L'aria all'interno deve essere rilasciata tramite sfiato quando si apre la valvola dell'acqua calda.

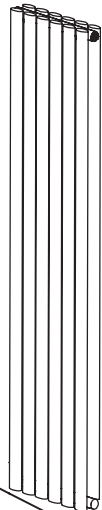

Dopo l'installazione:

- Aprire la valvola di sfiato con un cacciavite, aprire la valvola e far fluire l'acqua nel radiatore. Controllare che tutti i collegamenti siano ben saldi.
- Quando l'acqua trabocca dalla valvola dell'aria, non c'è più aria nei tubi.
- Chiudere la valvola dell'aria con un cacciavite, riaccendere la valvola e il radiatore pronto per l'uso.

Manutenzione:

- I radiatori classici sono realizzati in acciaio cromato e non devono essere puliti con detergenti corrosivi o abrasivi.

Si prega di notare

- Questo prodotto può essere utilizzato solo a PN «1MPa (10g/cm², 10 Bar) e deve essere riempito solo con acqua e a una temperatura inferiore a 100° C. Fare riferimento alla seguente tabella per i requisiti di installazione.
- Se la temperatura supera i 48° C (o 120° F), esporre un cartello di avvertimento vicino al prodotto per evitare ustioni e l'esposizione alle radiazioni.

Riempire per 3/4	Pressione	Temperatura di esercizio	Osservazioni
Solo acqua	PN ≤ 1Mpa	0°C < t ≤ 100°C	Se la temperatura ambiente scende sotto 1° C, scaricare l'acqua per evitare il congelamento.

