

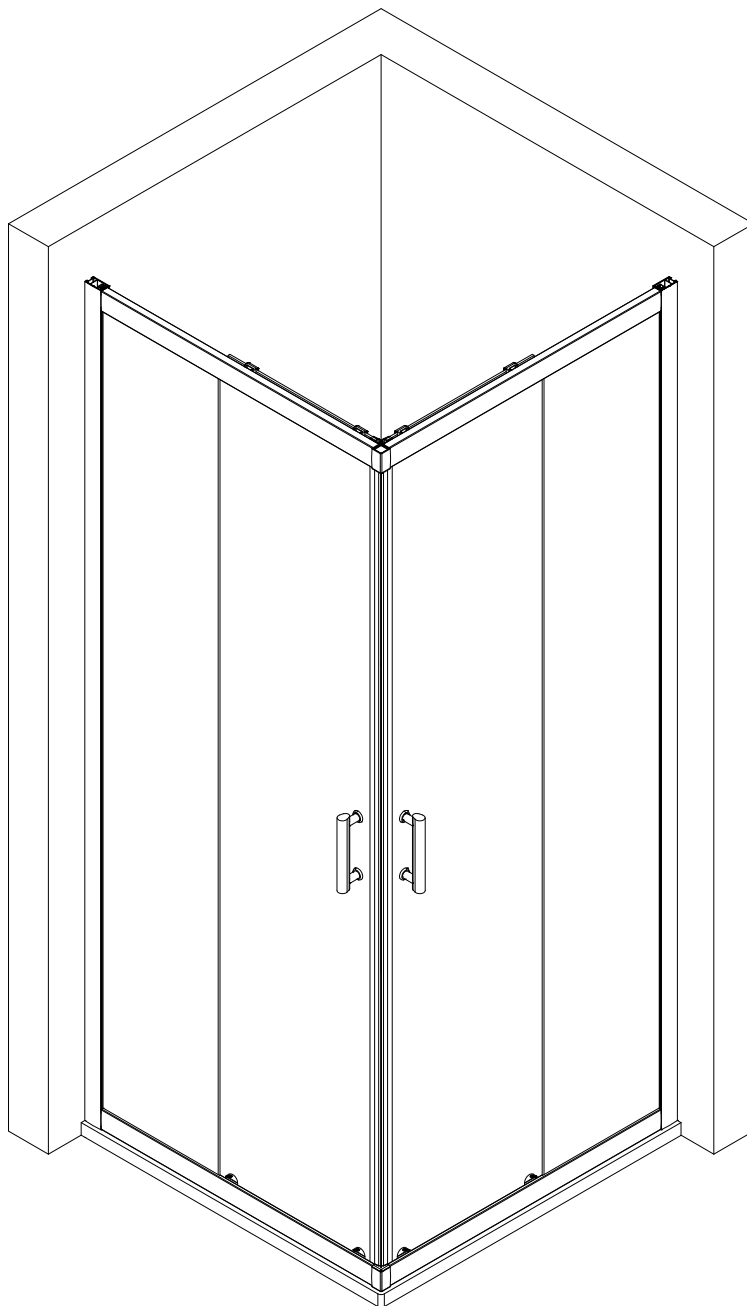

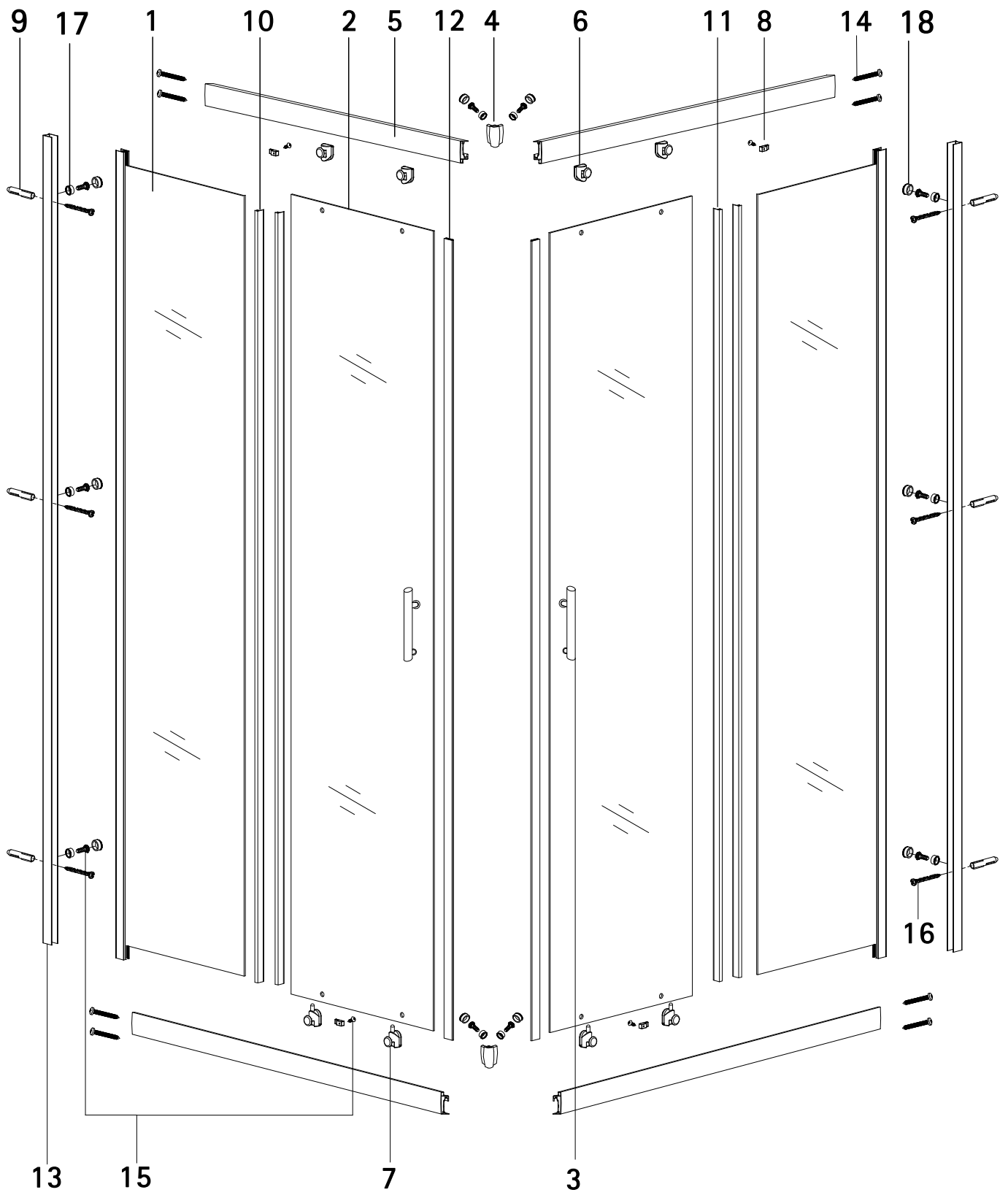

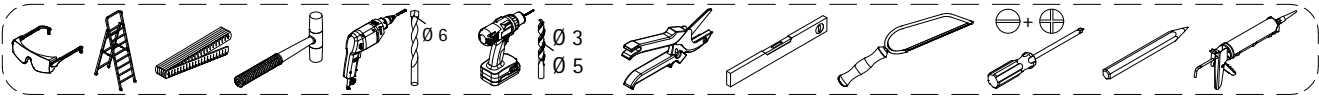



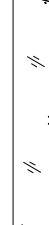

- Montageanleitung
- Assembly instructions
- Notice de montage
- Montagehandleiding
- Návod na montáž
- Instrucțiune de montaj
- Navodila za namestitev
- Installationstruktioener

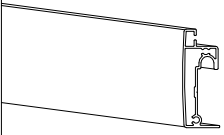
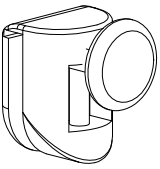
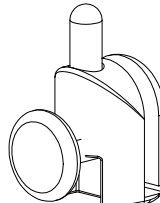
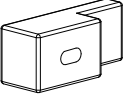
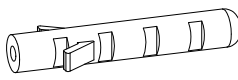
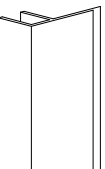

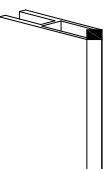
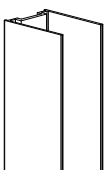

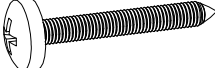

<p>1</p>  <p>X2</p>	<p>2</p>  <p>X2</p>	<p>3</p>  <p>X2</p>	<p>4</p>  <p>X2</p>
<p>5</p>  <p>X4</p>	<p>6</p>  <p>X4</p>	<p>7</p>  <p>X4</p>	<p>8</p>  <p>X4</p>
<p>9</p>  <p>X6</p>	<p>10</p>  <p>X2</p>	<p>11</p>  <p>X2</p>	<p>12</p>  <p>X2</p>
<p>13</p>  <p>X2</p>	<p>14</p>  <p>3,9 x 50mm</p> <p>X8</p>	<p>15</p>  <p>3,9 x 10 mm</p> <p>X14</p>	<p>16</p>  <p>3,9 x 30 mm</p> <p>X6</p>
<p>17</p>  <p>X10</p>	<p>18</p>  <p>X10</p>		

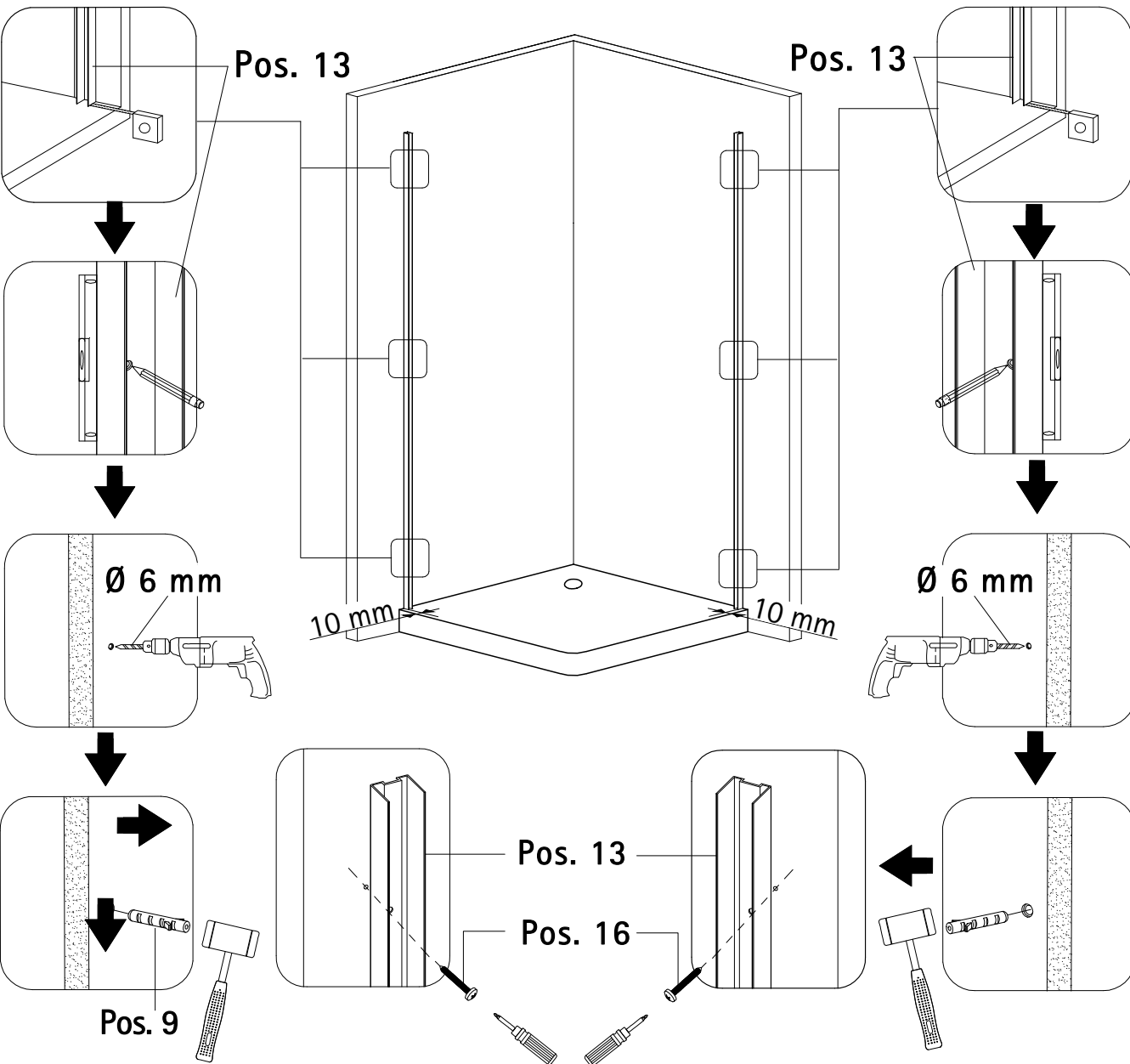
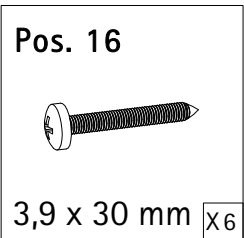
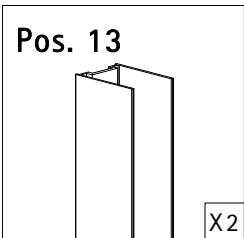
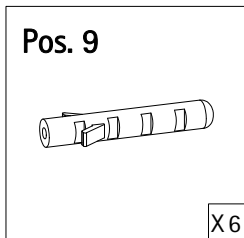
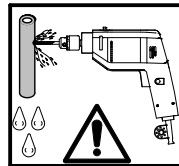
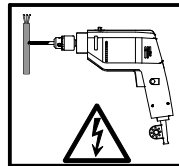
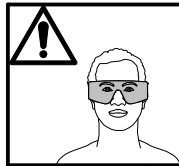
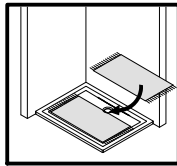

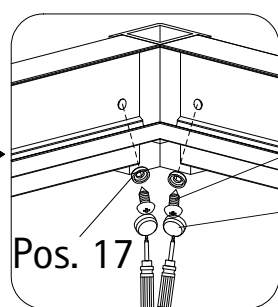
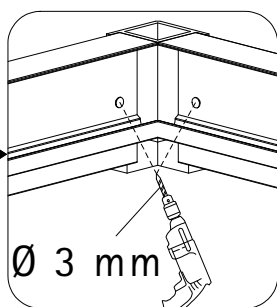
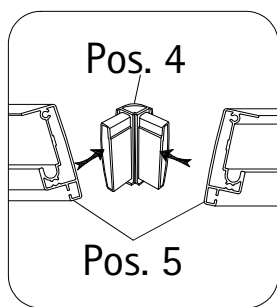
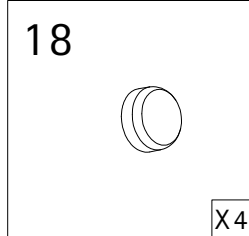
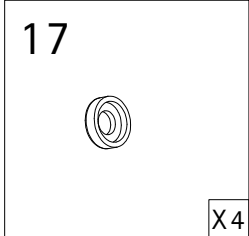
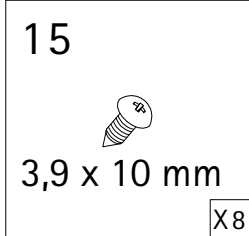
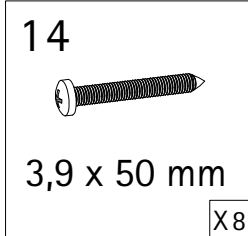
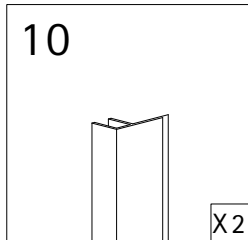
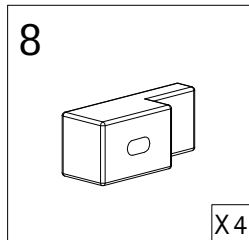
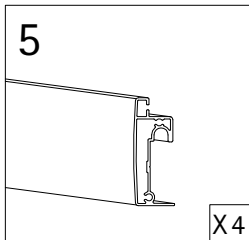
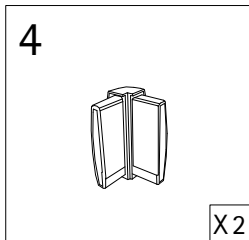
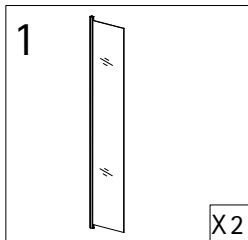

Pos. 15
Pos. 18
Pos. 14

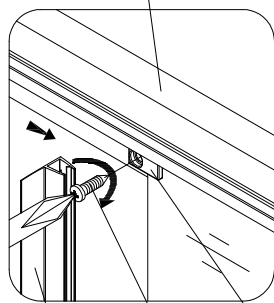

Pos. 10
Pos. 8
Pos. 15

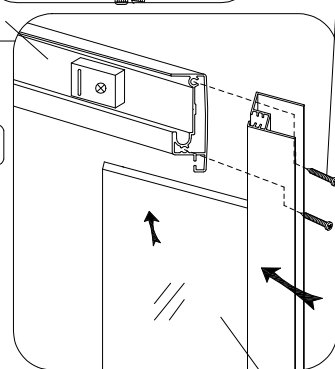
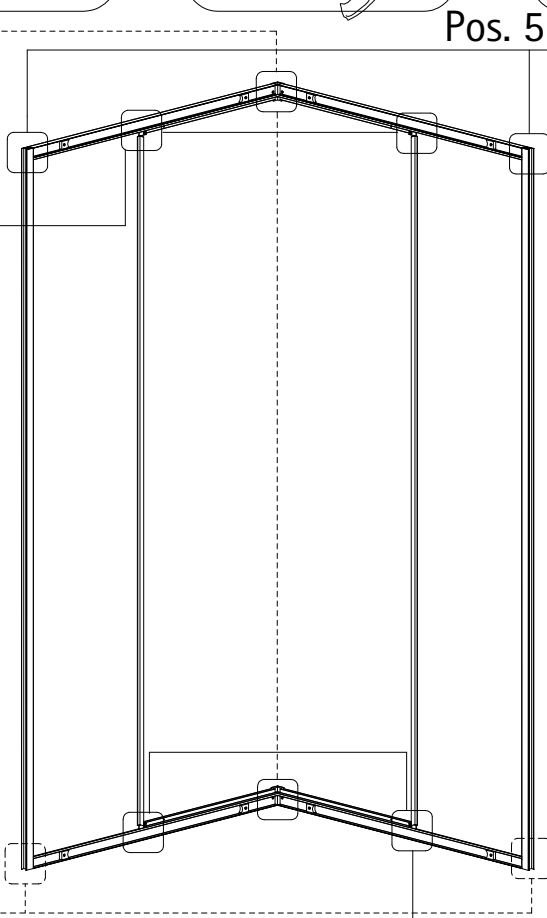

Pos. 10
Pos. 1

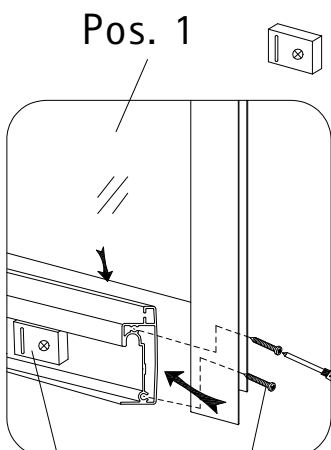
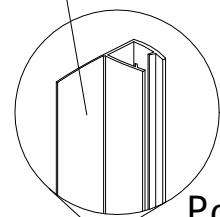

Pos. 5
Pos. 14

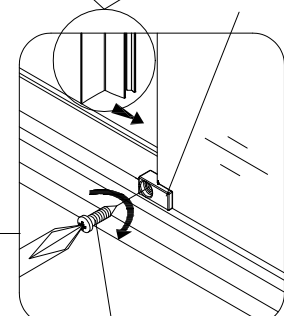

Pos. 15

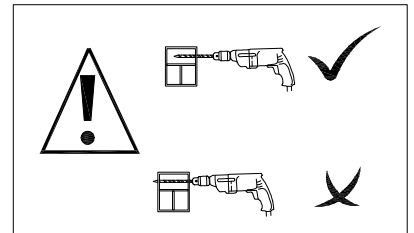
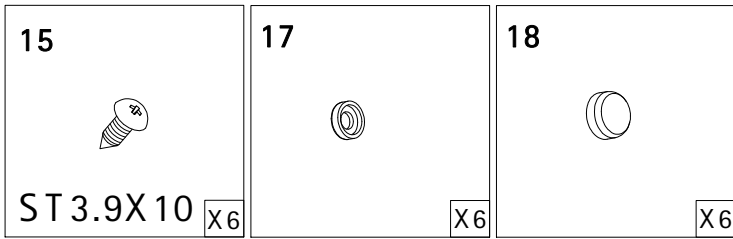

Pos. 13 Pos. 5

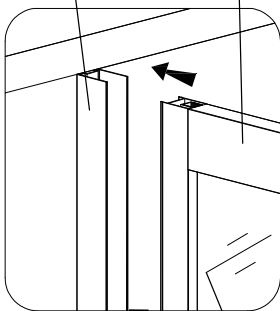

Pos. 1

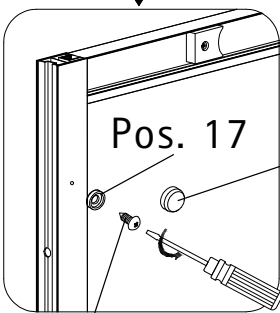
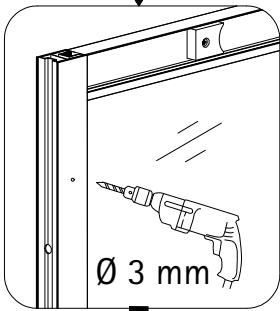

Pos. 15

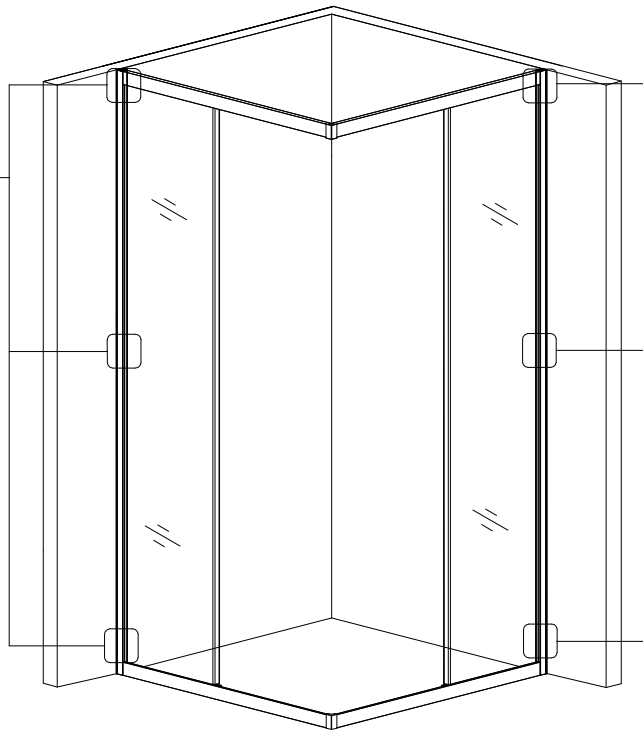

Pos. 5 Pos. 13

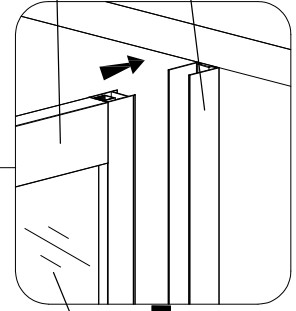

Pos. 1

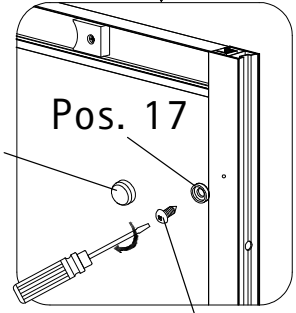
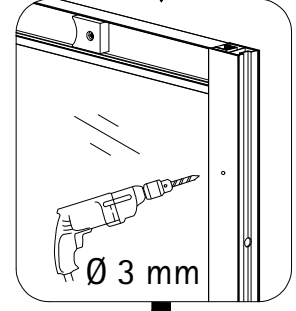

Pos. 15

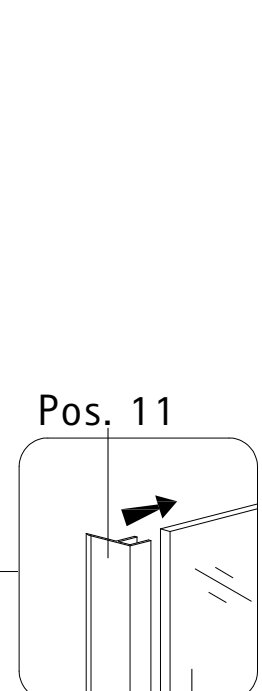
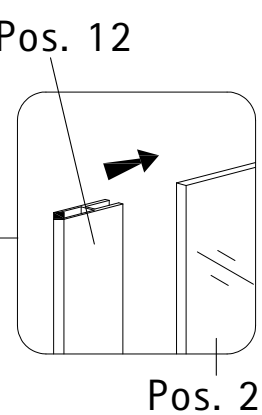
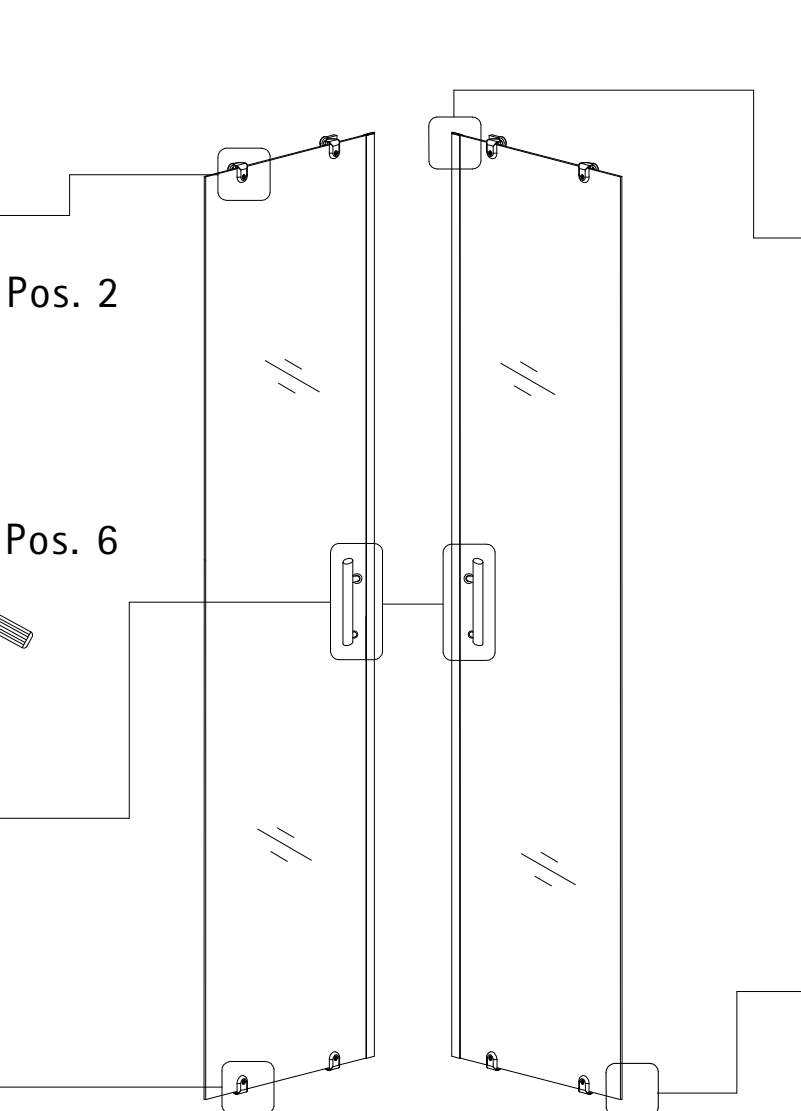
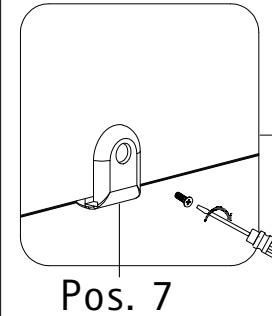
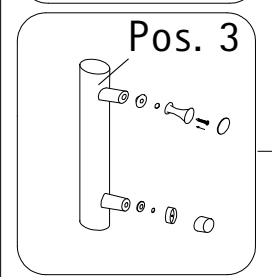
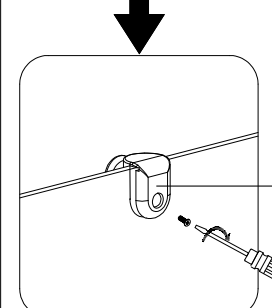
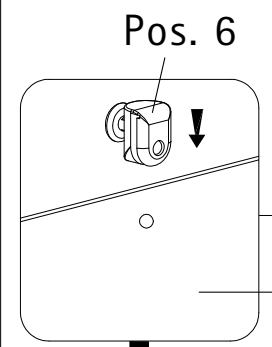
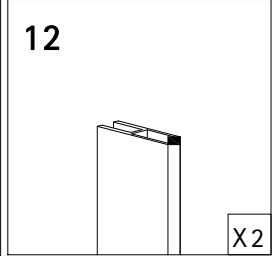
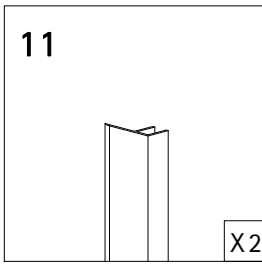
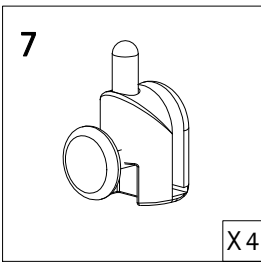
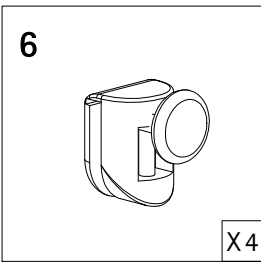
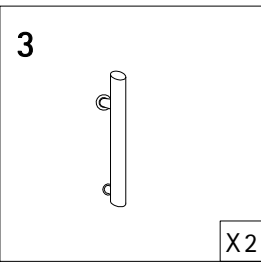
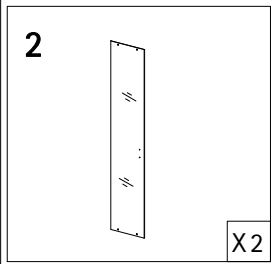

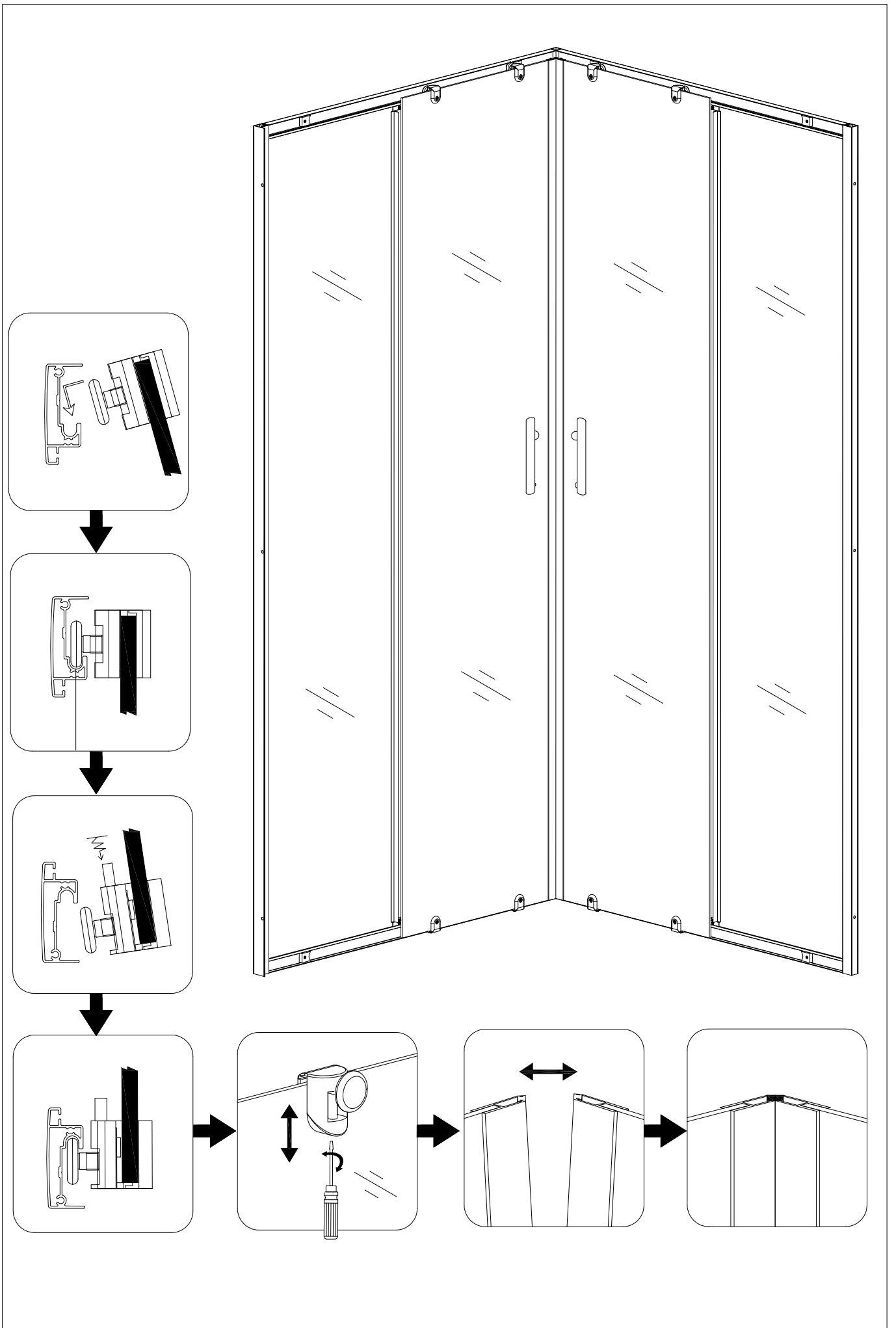



Notizen, notes, notities

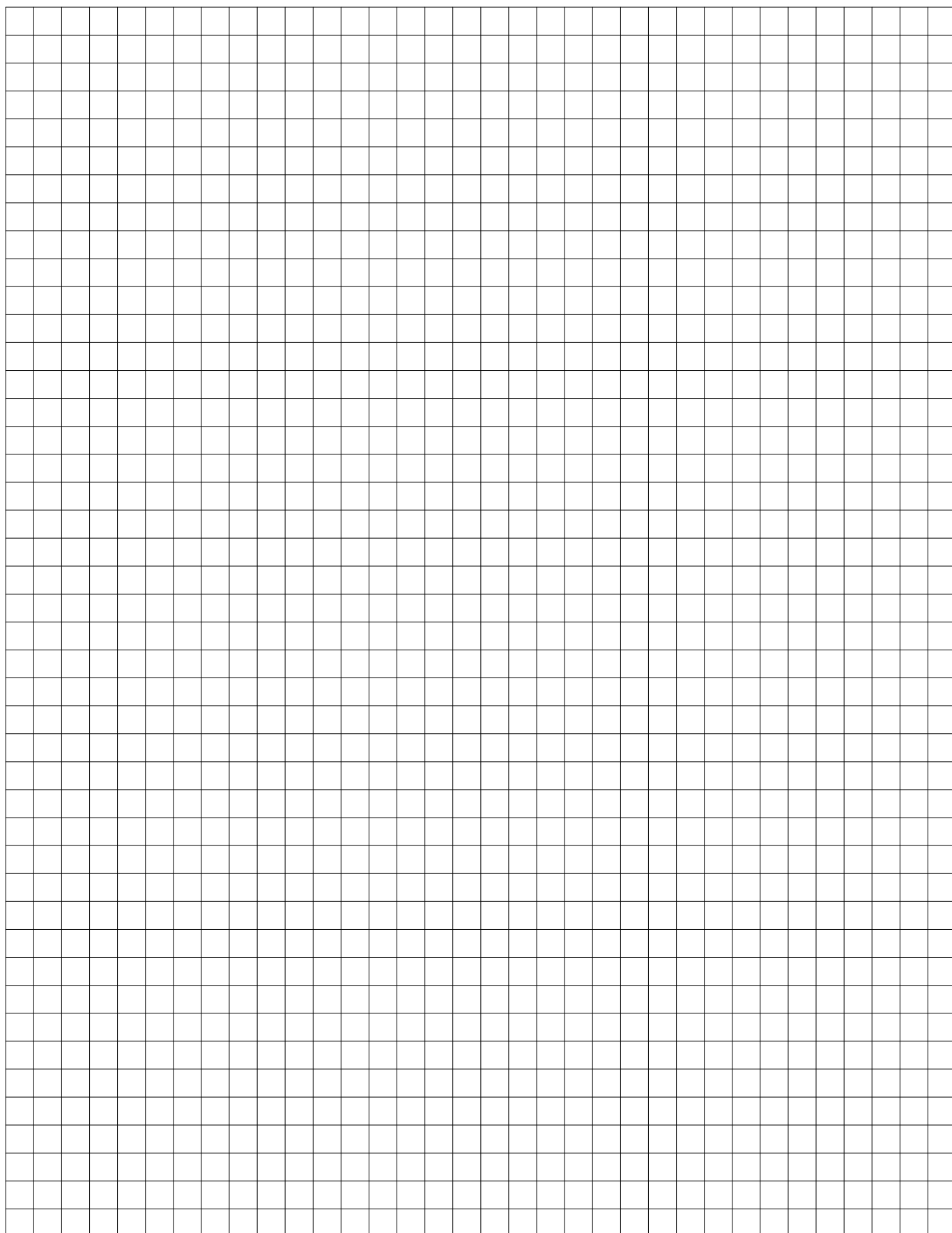

Notizen, notes, notities

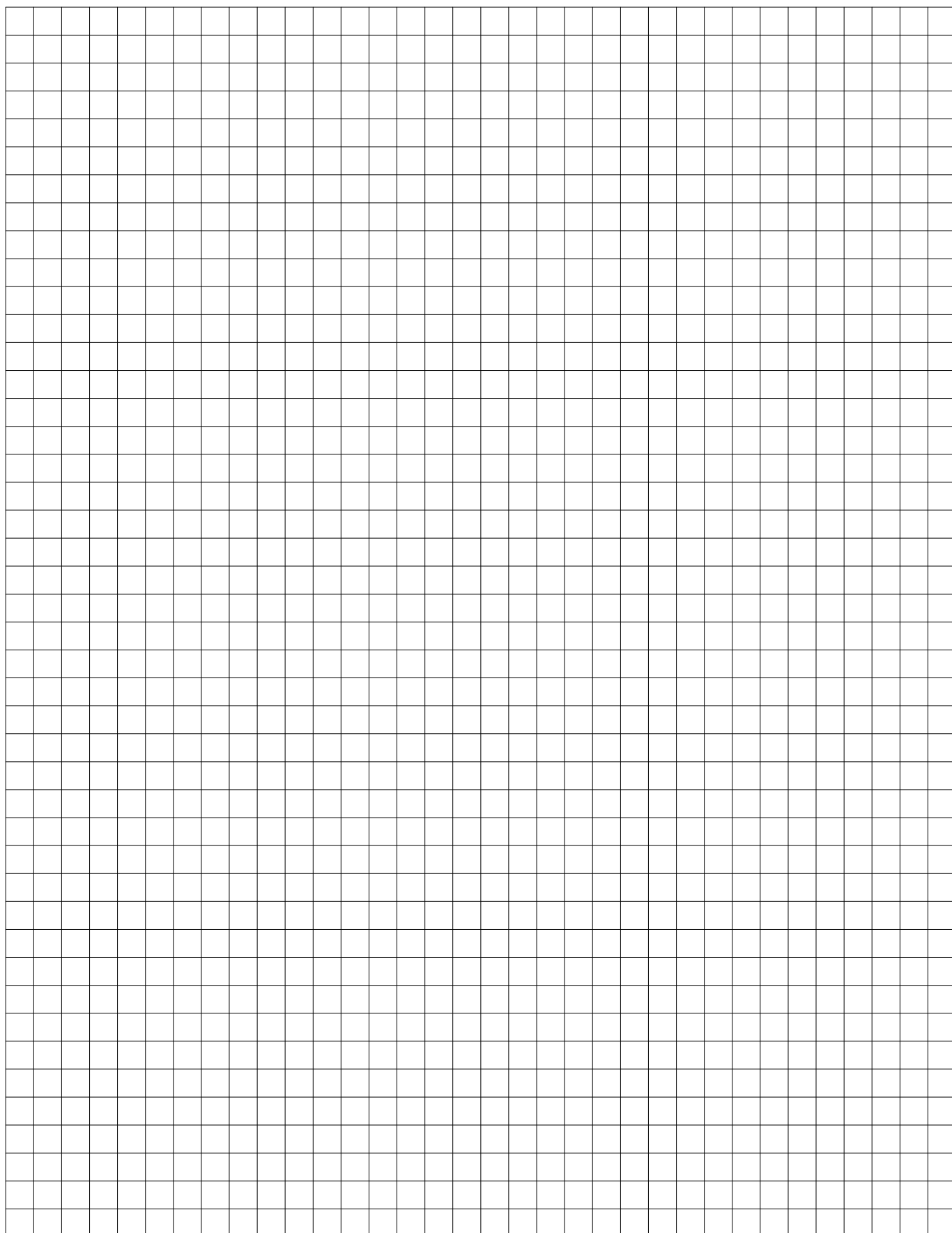

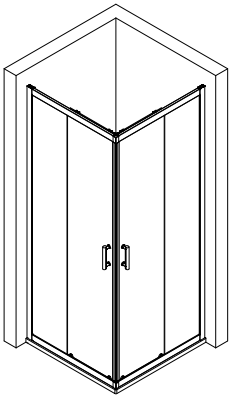

1914-2

Kontrollbeleg
Control Receipt

Prüfnummer/ Inspection number



Duschkabinenbau
Am Lindhövel 1
59846 Sundern
Deutschland / Germany / Allemagne / Duitsland



Allgemeine technische Probleme:
Telefon 02935 / 96 53 444



E-Mail:
onlineservice@schulte.de