

COSTWAY

OP3569/OP3571

Side Awning Screen

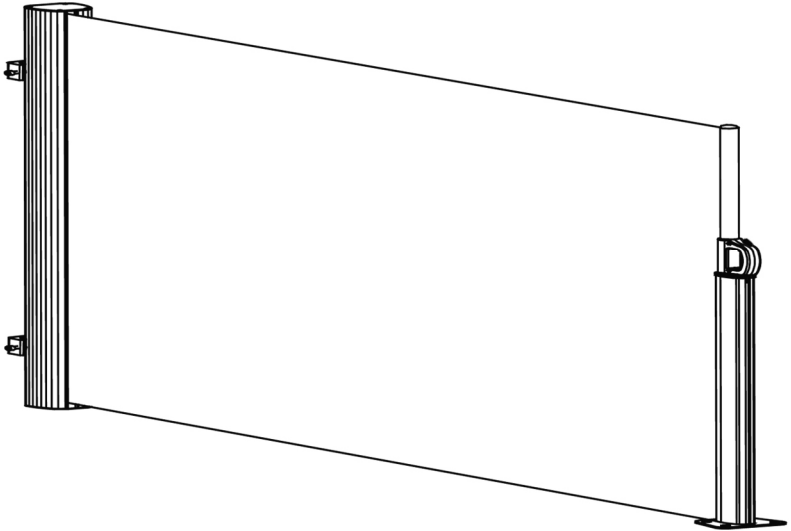

The manufacturer is constantly improving all types and models. Please understand that changes to the delivered product in terms of form, features and technology are thus possible at any time.

Therefore no claims may be derived from the information, illustrations and descriptions in this manual. Reprint, duplication or translation, also of excerpts, is not permitted without the written permission of the manufacturer.

All rights according to the law or to copyright law are expressly reserved by the manufacturer.

Subject to alterations

THE CARTON INCLUDE FOLLOWING PARTS:

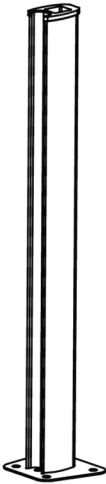

**Stand fix
(x1 piece)**

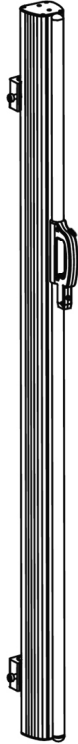

**The cassette part
(x1 piece)**

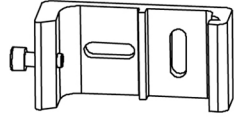

Brackets (x2 pieces)

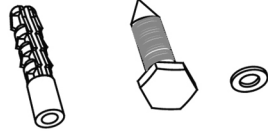

**$\phi 10 \times 50$ anchor bolt,
M6 $\times 60$ hexagon wooden screw
 $\phi 6$ washer (x4 pcs)**



**$\phi 10 \times 50$ anchor bolt,
M8 $\times 75$ hexagon wooden screw,
 $\phi 8$ washer (x4 pcs)**

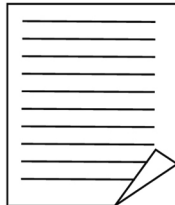

**Instruction manual
(1piece)**

**Please prepare the following tools before installation
(these tools are not provided)**

1. Tape measure
2. Hexagonal spanner CR-V5mm
3. Cross screwdriver
4. Drill machine

INSTALLATION STEPS

Warning: When mounting the awning, keep the main part and stand column on the horizon, or the fabric will be deformed and difficult to open and close.

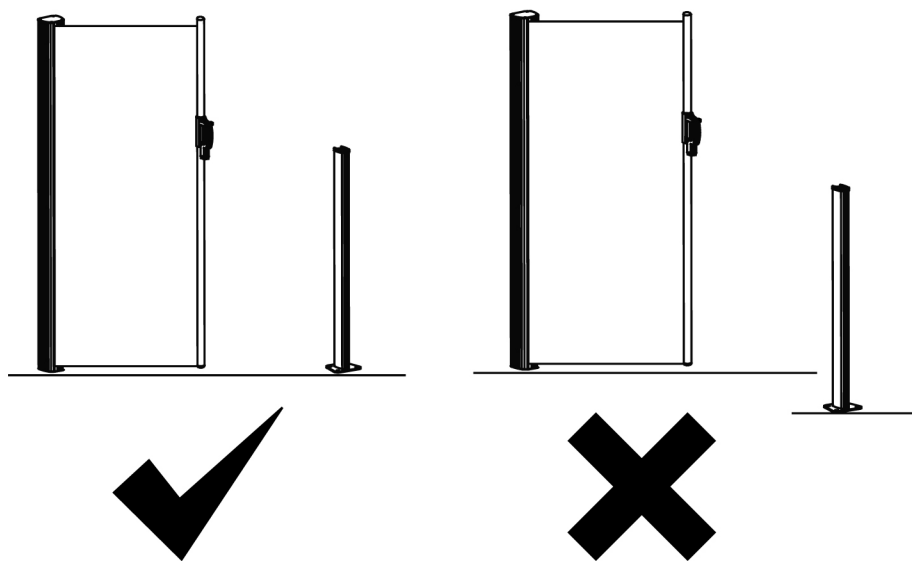

1. Drill 6cm deep holes in the size as the following picture shows

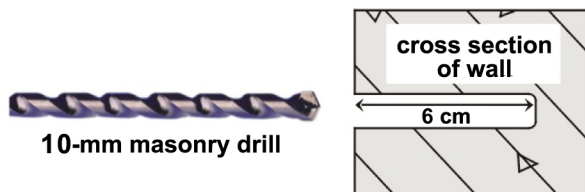

1.

2. Insert one $\phi 10 \times 50$ mm anchor bolt in each of holes.

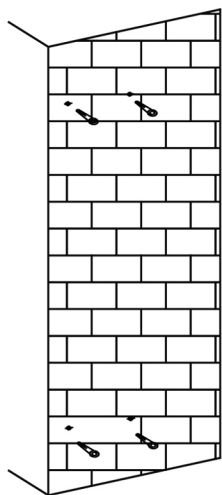

2.

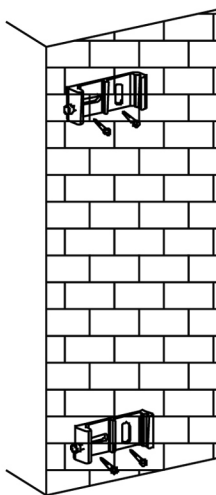

3.

3. Fix the bracket with M6×60 mm hexagon wooden screw
4. Insert the cassette part into the bracket, tighten the flat fillister head screw M6×16mm with Hexagonal spanner CR-V5mm

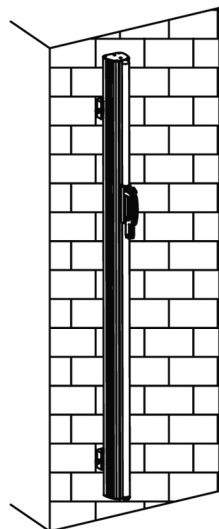

4.



10-mm masonry drill

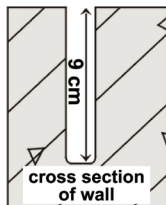

5.

5. Drill four 10mm diameter holes on the floor in the size as shown in picture 5 .

6. Insert one $\phi 10 \times 50$ mm anchor bolt (4pcs)

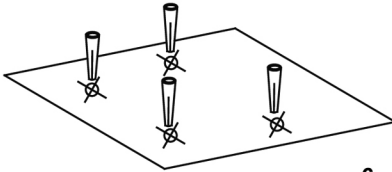

6.

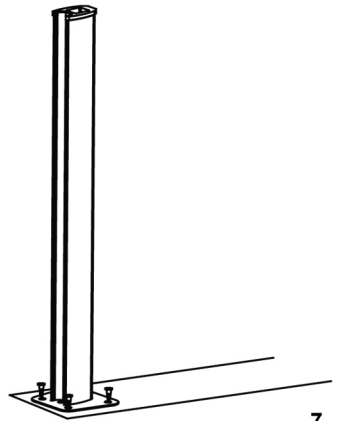

7.

7. Make the left bottom hole of stand fix and the hole on the floor alignment, and tighten them with M8 \times 75mm hexagon wooden screw.

CORRECT USE

1. Keeping the front bar upright, hold the handle and push it above the stand column. Hold the handle and press the handle spindle that the pin comes into the handle, and then put the handle into the stand column.

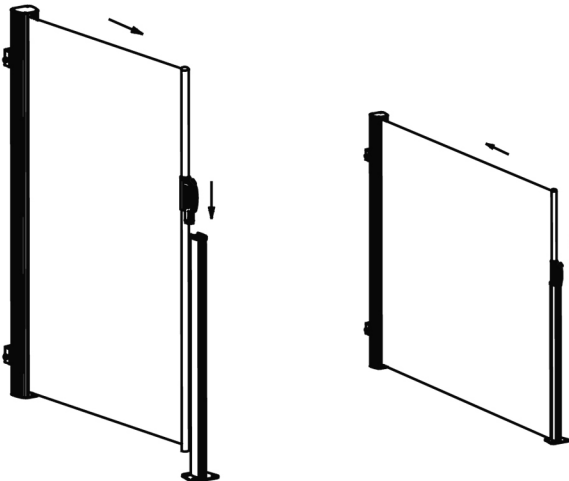

2. When you want to close it, hold the handle and pull up the handle spindle. Keeping the fabric horizontal and push the handle back to the cover slowly.

