

eArc SMF
Installation Manual
for Profiled Steel Roofs

Contents

1.0 Summary.....	1
1.1 Disclaimer.....	1
1.2 Responsibility.....	1
1.3 Copyright and Trademark Information.....	1
1.4 Warranty Warnings.....	2
1.5 For Further Information.....	2
2.0 Safety precautions.....	3
3.0 Mechanical / electrical properties.....	5
4.0 Storage and unpacking.....	6
5.0 Installation.....	7
5.1 Module wiring.....	9
5.2 Grounding.....	9
6.0 Installation instructions.....	10
6.1 Module and tools.....	10
6.1.1 Module.....	10
6.1.2 Construction materials.....	10
6.2 Unpacking, Handling and Checking Precautions.....	12
6.3 Construction Precautions.....	12
6.4 Precautions and Tips for Gluing Modules.....	13
6.5 Construction plan.....	13
6.5.1 Cleaning the roof surface.....	13
6.5.2 Positioning and releasing the line.....	14
6.5.3 Gluing.....	14
6.5.4 Laying modules.....	17
6.6 Wiring and testing.....	19
7.0 Maintenance.....	21
Annex A.....	22

Electrical performance parameter	22
Annex B	23
Cleaning agent	23
Annex C	24
Gluing operation specification	24
1. Gluing nozzle cutting	24
2. Electric glue gun adjustment	25
3. Gluing parameters	26
4. Structural adhesive form	27
Annex D	28
Unpacking	28

1.0 Summary

Thank you for purchasing Sunman eArc PV modules. This guide contains information regarding the installation and safe handling of Sunman (Zhenjiang) Company Limited eArc SMF PV system on profiled steel Roofs. Sunman (Zhenjiang) Company Limited referred to as “SUNMAN”. Users and installers must read and strictly follow the installation manual. Failure to follow these safety guidelines can result in personal injury or property damage. The installation and operation of solar modules require specialized skills, and only professionals can do the job. Please read the safety and installation instructions before using and operating the modules. The installer must inform the end customer (or consumer) of the above matters accordingly.

1.1 Disclaimer

Sunman reserves the right to change this installation manual without prior notice. The changes and the latest installation manuals after the changes will be published in the resource center of the official Sunman website. Customers should always pay attention to the above changes. Sunman will not provide further notice.

Failure in operating according to instructions in this manual during installation (Including the changes announced on the official website of Sunman at the time of installation) will cause the warranty to be invalid.

Sunman does not guarantee any expressed or implied information contained in this manual.

1.2 Responsibility

Whether or not the installation of the modules is carried out in accordance with the instructions in the installation manual (Including the changes announced on the official website of Sunman at the time of installation), Sunman shall not be held legally responsible for any damages incurred during the installation process, including but not limited to personal and property damage resulting from the operation of the modules and the installation of the system.

1.3 Copyright and Trademark Information

Copyright © 2023 by Sunman (Zhenjiang) Company Limited. All rights reserved. eArc and the SUNMAN logo are trademarks of Sunman (Zhenjiang) Company Limited.



1.4 Warranty Warnings

WARRANTY VOID IF NON-SUNMAN-CERTIFIED HARDWARE IS ATTACHED TO eArc™ PV System.

1.5 For Further Information

For additional technical support documentation, please visit the Support page of the SUNMAN website at 'www.sunman-energy.com'.

2.0 Safety precautions



WARNING: Please read and understand all safety instructions before installing, wiring, operating, or maintaining modules. DC power is generated when the module is exposed to sunlight or other light sources. Direct contact with live parts of the module, such as terminals, whether connected or not, may result in personal injury or death.

Safety rules

- All installation work must be in full compliance with local regulations and corresponding national or international electrical standards.
- Use insulated tools to reduce the risk of electric shock.
- Use appropriate protective measures (slip gloves, overalls, etc.) to avoid direct contact with workers at 30V DC or higher, while avoiding direct contact with sharp edges during installation to protect the operator's hands.
- Do not wear metal ornaments when installing, to avoid puncturing the modules and causing electric shock.
- If modules are installed or operated on rainy days, strong winds or dew mornings, appropriate protective measures should be taken to avoid injury to modules and workers.
- Children or unauthorized personnel are not allowed to access the installation area or module storage area.
- If the circuit breaker and overcurrent protection circuit breaker cannot be opened, or if the inverter cannot be turned off during the module installation or wiring, cover the array modules with opaque material to stop the power output.
- Do not use or install damaged modules.
- If the module surface is damaged or worn, direct contact with the surface of the module may result in electric shock.
- Do not attempt to repair any part of the module, there are no user-accessible components within the module.
- The cover of the junction box should remain closed at all times.
- Do not split the modules or move any part of the module.
- Do not artificially condense light on modules.

- Do not connect or disconnect modules when there is current in the module or external current.

3.0 Mechanical / electrical properties

The rated electrical performance data for the modules is measured under standard test conditions (STC) of irradiance of 1000 W/m², AM 1.5, and cell temperature of 25 °C. The specific electrical and mechanical performance parameters of Sunman eArc modules are included in Annex A of this installation manual. The main electrical performance parameters under STC conditions are also marked on the nameplate of each module. The maximum system voltage for all modules is 1000V.

In some cases, the current or voltage generated by the module may be greater than the optimal operating current or voltage of its standard test condition (STC). Therefore, when determining the component rating and load value, the module open circuit voltage and short circuit current at STC should be multiplied by 1.25. Please check with your local rules and regulations.

4.0 Storage and unpacking

Precautions and general safety rules

- Store modules in a dry and ventilated environment.
- The modules must be transported in the package provided by Sunman and stored in the original package before installation. Please protect the packaging from damage. Open the package according to the recommended unpacking steps. Care must be taken during unpacking, shipping, and storage.
- Do not apply excessive loads on the modules or twist the modules.
- Do not carry the modules through the wires or junction boxes of the modules.
- Do not stand, climb, walk or jump on modules.
- Do not allow sharp objects to touch the modules. Scratches can directly affect the safety of the modules.
- Do not place the modules in an environment where there is no reliable support or is not fixed.
- Do not change the wiring method of the bypass diode.
- Keep all electrical connections clean and dry.

Product identification

- Barcode: each individual eArc has a unique serial number. The serial number has 21 digits. The 1st to 4th digits are the module type for internal use, and 5th to 8th digits are the year code, and the 9th and 10th digits are the month code, and the 11th and the 12th digits are the week code, and the 13th and 14th digits are the month code, and the 15th to 17th digits are order number, and the 18th to 21th digits are the sequence codes. For example, xxxx20210415xxxxxxxx means the module was made in the 15th week of 2021. Each module has only one bar code. It is permanently attached to the interior of eArc and is visible from the top front of eArc. This bar code is inserted prior to lamination.



- There is a nameplate, which shows the model number, main electrical properties, safety specifications and certification indicator, on the back of each module.

5.0 Installation

Precautions and general safety rules

- Before installing the modules, please contact the relevant department to obtain information about the installation site and the construction permit, and also comply with the installation and inspection requirements.
- Check the applicable building codes to ensure that the building to be installed and its structure (roof, facade, load-bearing, etc.) has sufficient load-bearing capacity.
- During installation, make sure that the modules are installed on a fire-resistant roof. According to UL790 standards, Sunman eArc modules are rated as fire rating C.
- The eArc modules are compliant with application level A (equivalent to safety level II, IEC 61730-1). This type of modules can be used in systems where the public is likely to come into contact with voltages greater than 50V or power greater than 240W.

Environmental conditions

The modules are suitable for general climatic conditions, ie with reference to IEC 60721-2-1- Classification of environmental conditions Part 2-1: Environmental conditions occurring in nature - temperature and humidity.

- If the modules are used in a special installation environment, please consult the technical support department of Sunman in advance.
- The installation surface should be flat without bumps or pits.
- The modules must not be installed near flames or flammable objects.
- Do not expose modules to artificial condensing light sources
- The modules should not be immersed in water (pure water or salt water), installed in long-term water environment (pure water or salt water) (eg fountains, sprays, etc.) or area prone to water accumulation (eg roof drain, low-lying areas, etc.).
- Please consult SMF installation manual for Flat roofs if roof area has poor drainage or extended water pooling.
- If the module is placed in a salt mist (ie marine environment) or in an environment containing sulfur (ie, sulfur sources, volcanoes, etc.), there is a risk of corrosion.

- **Failure to follow the above precautions, Sunman Warranty will be voided.**

Installation requirements

- Ensure the modules meet the overall technical requirements of the system.
- Ensure that components of other systems do not cause damaging mechanical or electrical performance effects on the modules.
- Connect modules in series to increase voltage or in parallel to increase current. When connected in series, the positive pole of the module is connected to the next negative pole. When connected in parallel, the positive pole of the module is connected to the positive pole of the next module.
- The number of bypass diodes provided varies depending on the module model.
- Connect the appropriate number of modules according to the voltage specifications of the inverter used in the system. Even at the lowest local temperature conditions, the connected modules must produce no more than the voltage allowed by the system. If overcurrent protection devices (fuse) are not used in series within each string of modules, up to two strings of modules can be connected in parallel. If a suitable overcurrent protection device is connected in series with each string of modules, three strings or more modules can be connected in parallel.
- In order to avoid (or reduce) the mismatch effect of the array, it is recommended to connect modules of similar electrical performance on the same string.
- In order to reduce the risk of indirect lightning strikes, loops should be avoided when designing the system.
- The modules should be securely fastened to withstand all possible loads, including wind and snow loads.

Optimal orientation and inclination

- In order to achieve maximum annual power generation, the optimal orientation and inclination of the PV module should be determined first. The maximum electrical energy is typically generated when sunlight is directed onto the PV module.

Avoid shadows

- Even small shadows (such as dust) can cause a drop in power generation. If all surfaces of the module are uncovered throughout the year, the module is considered "no shadow". Ensure that the sun shines on the modules even on

the shortest day of radiation all through the year.

- EVA aging caused by frequent occlusion of modules and long-term heating of the diode can affect the lifetime of the module.

5.1 Module wiring

Correct electrical wiring

- Check that the wiring is correct before starting the system. If the measured open circuit voltage (Voc) and short circuit current (Isc) do not match the specifications provided, there may be a wiring fault.

Correct connection of the MC4 connector

- Make sure the MC4 connector is secure and properly connected. The MC4 connector must not be subjected to external pressure. The MC4 connector can only be used for circuit connection functions and should not be used to turn the circuit on and off.
- The MC4 connector should be kept dry and clean to prevent rain and moisture. Avoid direct sunlight and water soaking of the MC4 connector.

Use appropriate materials

- Depending on local fire, construction and electrical standard, use dedicated solar cables and suitable MC4 connectors to ensure the electrical and mechanical performance of the cable.
- The solar cable licensed for use is a single-wire cable, 2.5-10mm² (8-14 AWG), 90°C grade, with appropriate insulation to withstand the maximum possible system open circuit voltage. The appropriate wire size needs to be chosen to reduce the voltage drop. The wire should be made of copper.

Cable protection

- Secure the cable to the mounting system with a cable tie that is UV resistant. Appropriate measures should be taken to protect the exposed cable from damage (eg. in a plastic sleeve with UV aging resistance). Avoid direct exposure of the cable to direct sunlight.

5.2 Grounding

- With adhesive on the back of SMF modules, there is no metal conductor for the module or the bracket, so no grounding of module is required.

6.0 Installation instructions

6.1 Module and tools

6.1.1 Module

Applicable module model: SMF430F-12X12UW

The electrical performance parameters are detailed in Annex A.

6.1.2 Construction materials

Aluminum support rail, silicone sealant (glue), plastic roller, cleaning tool, tape measure, thread release tool, etc.

■ Aluminum support rail

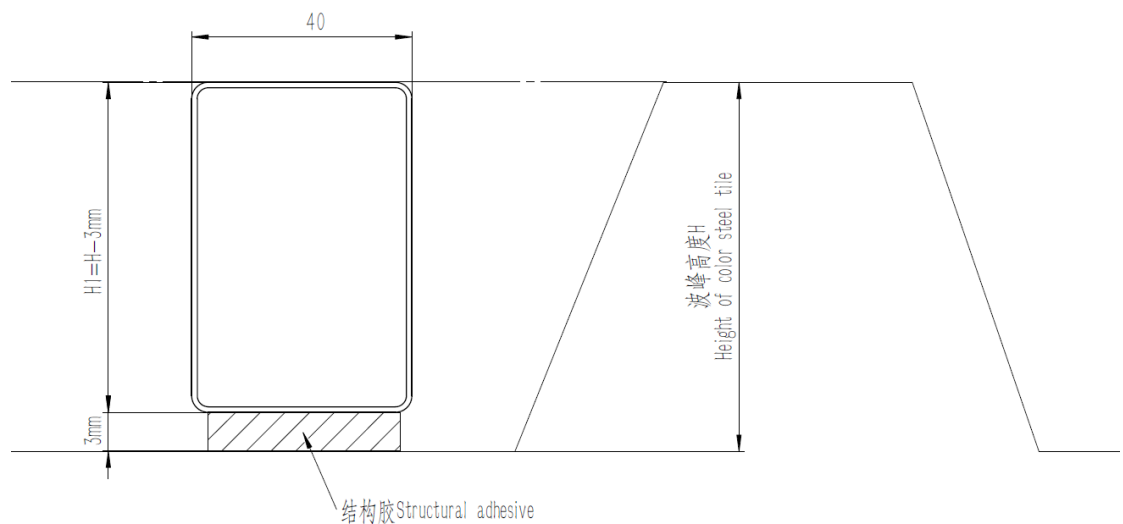

Material: Aluminum 6063-T5/T6.

Surface treatment: Anodic oxidation AA10 and above

Dimensions: $B=40\text{mm}$, $H1= (H-3\text{mm}) \pm 2\text{mm}$

■ Silicone sealant (glue)

Use Tonsan 1527 silicone sealant

(or other Sunman-approved silicone, otherwise the warranty will be invalid).



■ **Glue gun**



■ **Plastic roller and cleaning tool**

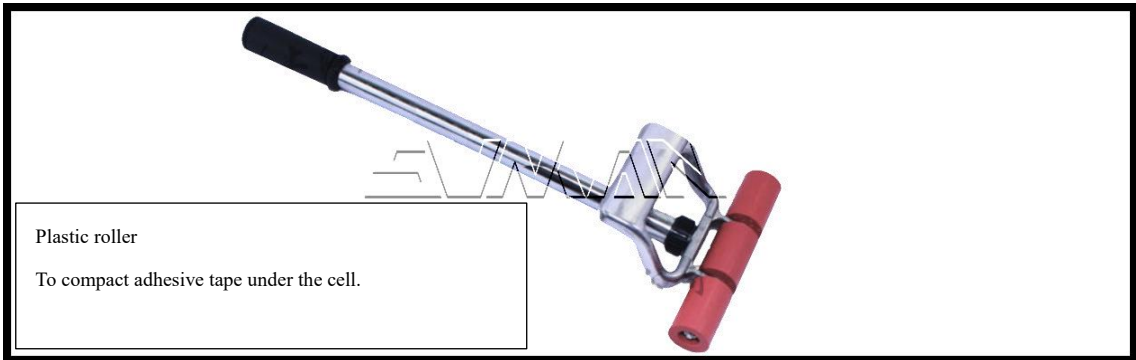

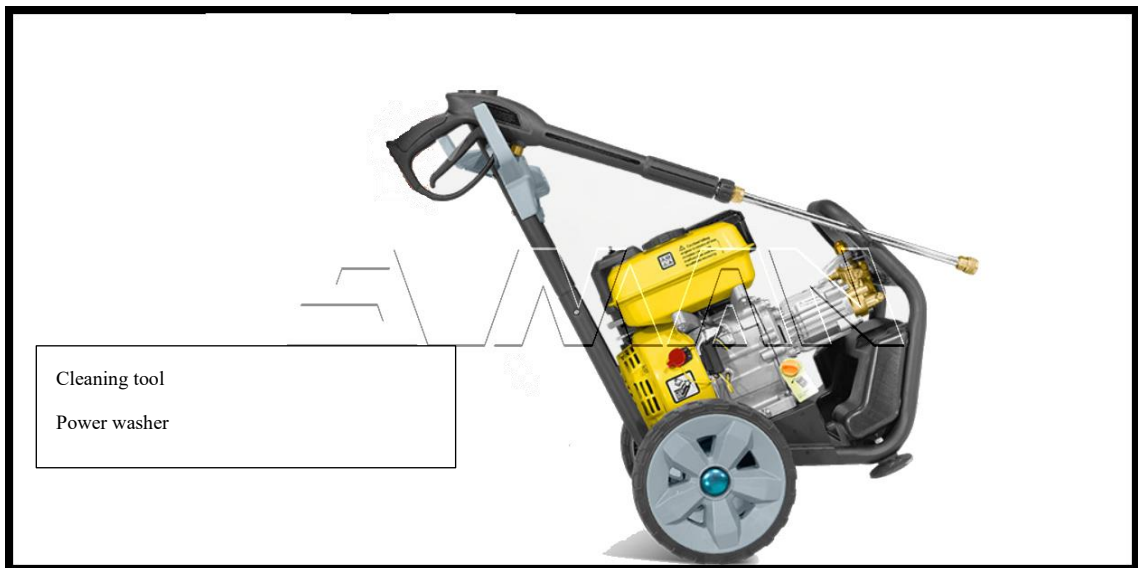

6.2 Unpacking, Handling and Checking Precautions

- Do not open modules outer Package before installation.
- Check the outer package for damage before unpacking.
- Slip-Proof Gloves are recommended for unpacking and handling.
- Do not grab the modules by the junction box or cables during unpacking or handling.
- Modules should be handled and lifted by at least two people. Do not touch the solar cell area during handling to avoid cell-cracks.
- Be careful while carrying the modules. Avoid hitting the modules on the ground or other sharp, hard objects. Scratches will affect the module's safe operation.
- Check the surfaces of the modules, make sure there's no damage to the frontsheet and the backsheet.
- Check the junction box, connectors, and cables for any damage. Double check if the junction box cover is fixed securely.
- Do not paint or apply glue or label on the surface of the modules.

6.3 Construction Precautions

- Normal construction can be carried out in the temperature range of -10 to 45 Celsius degrees (5 to 40 Celsius degrees is the best), and the humidity is below 80%rh.

- The surface of the roof must be cleaned or wiped dry, free of floating soil, oil, etc. In order to achieve the required adhesion, the roof shall be cleaned using the cleaning agent specified in Annex B or Sunman- approved cleaning agent.
- After initial installation, the panel and adhesion shall not be disturbed for 24 hours.
- The roof angle is within 10 degrees.
- The paste surface needs to be flat and free of pits or bumps.
- The height of the structural adhesive after pasting should not be less than 3mm. Do not use feet or other non-designated tools to compact the structural adhesive.

6.4 Precautions and Tips for Gluing Modules

- Please make sure the surface is cleaned and there are no water pits before gluing;
- Glue along the middle line of the trapezoid or wave crest. Width of silicone glue strips should exceed 10 mm and height of the strips should exceed 5 mm
- Applying the silicone glue should be a continuous and even movement. Please use a roller to spread out the glue strips evenly. Do not smooth out the lines of glue to spread them out;
- Make sure to complete the gluing and mounting over a duration that does not exceed 5 minutes;
- Silicone sealant will cure to a depth of 2-3mm in 48 hours. Do NOT apply any force on the module before curing is complete;

6.5 Construction plan

Installation steps

6.5.1 Cleaning the roof surface

Remove debris from the roof base and use a designated or approved cleaning agent (Annex C) to clean the roof. If the roof is very dirty, use a low-pressure water spray or power washer before using the cleaner. Optionally, use a mixture of 1/4 cup of trisodium phosphate, 1/2 cup of liquid cleaner and 5 gallons of water for cleaning.

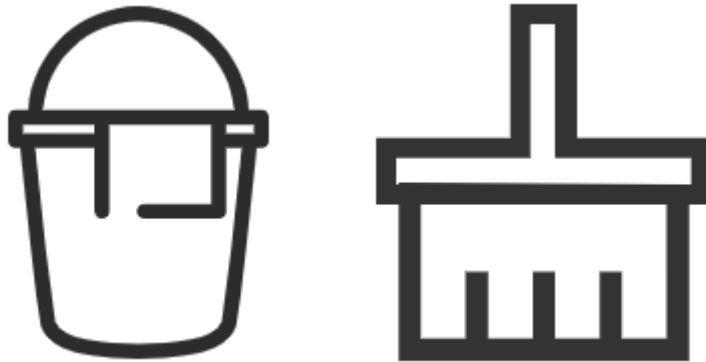

6.5.2 Positioning and releasing the line

Locate the line and determine the installation position of the module.

6.5.3 Gluing

- Glue the silicone sealant on the wave crest.



- The glue length L2 is the same at the width of PV panel, distance between glue L1 should be less than 520mm, If module hanging part is above 50mm, use Aluminum support rail.

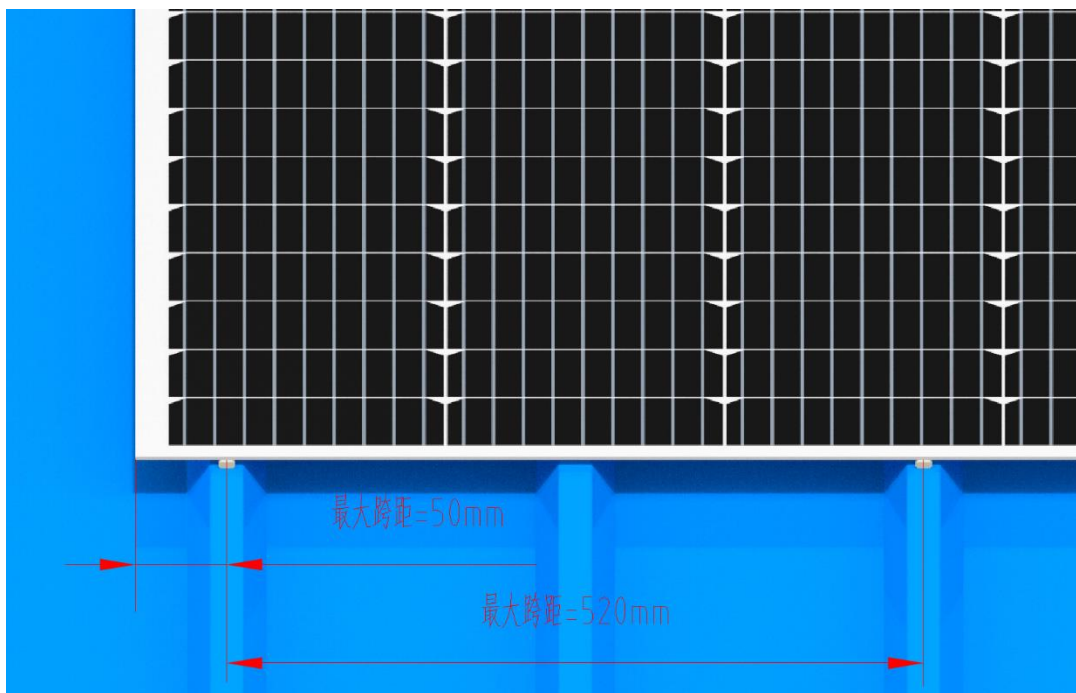
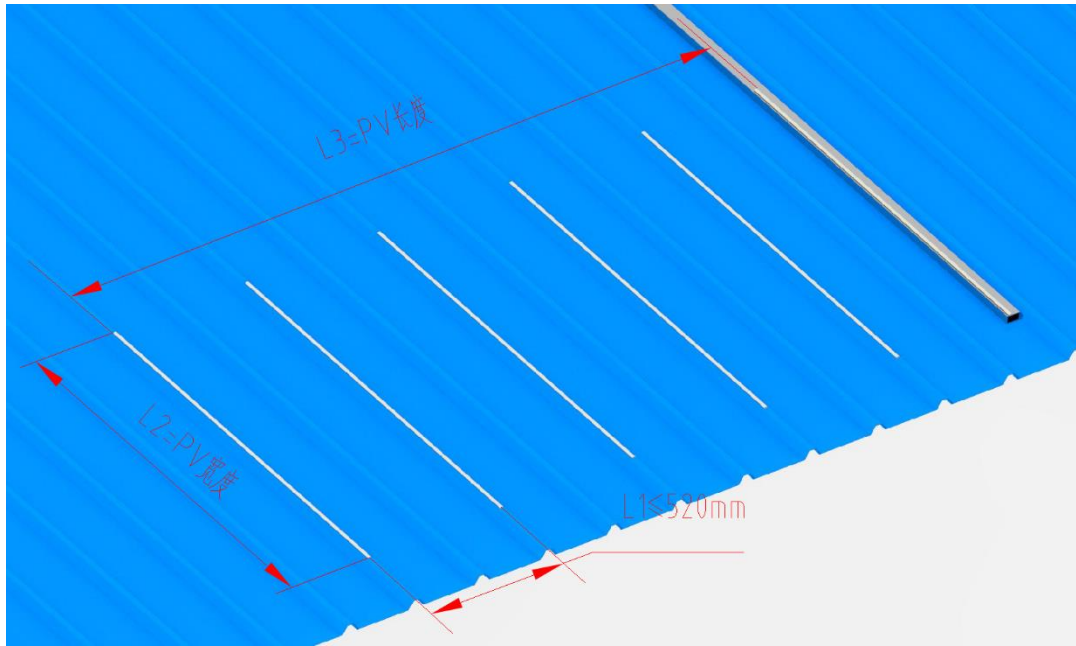

- If there is a joint in the aluminum tube, the priority is to put the joint between the modules.

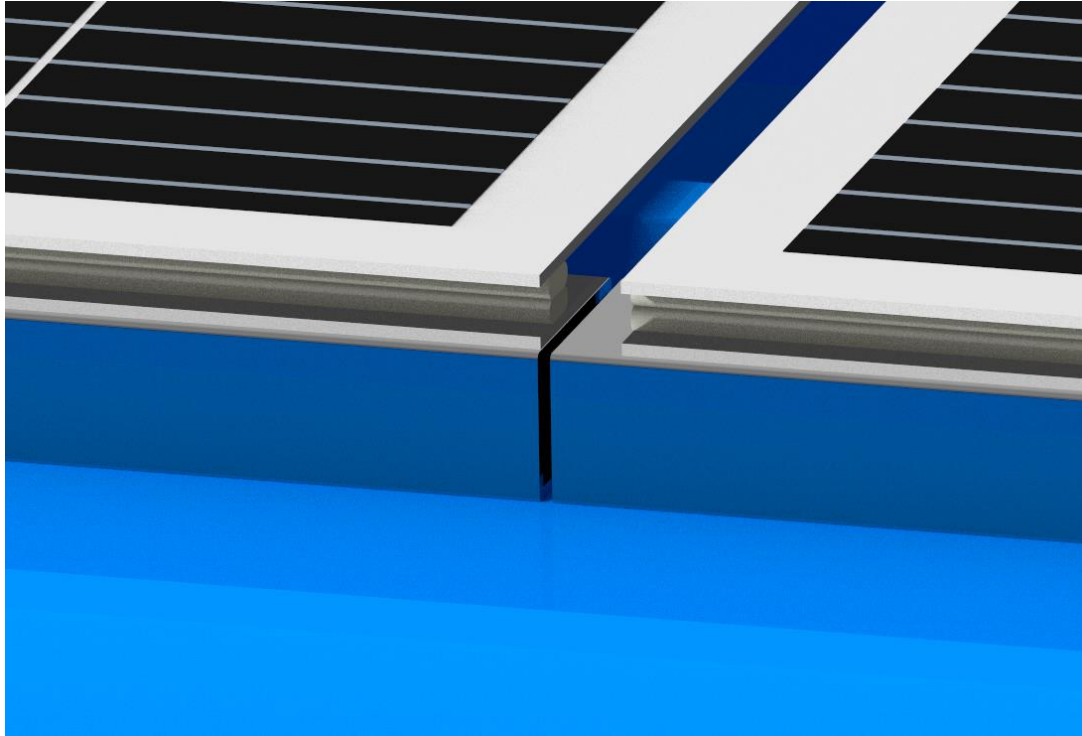

- If the joint must be located underneath the module, the joint must be fixed with connectors.
- It is prohibited to place a joint without a connector underneath the module.

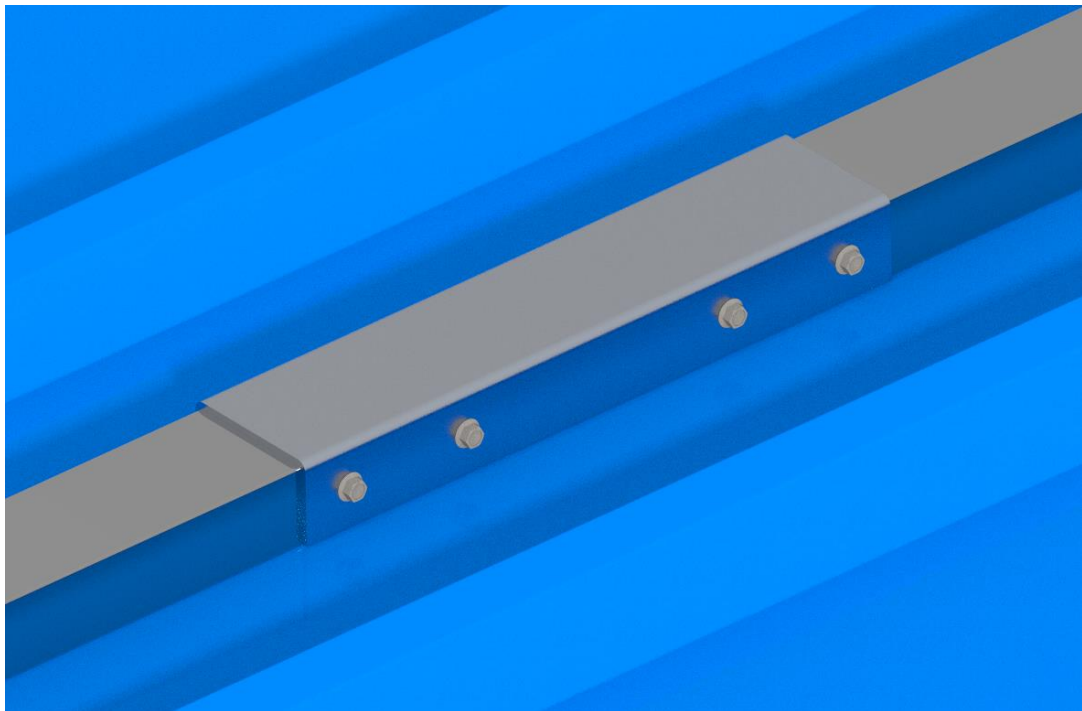

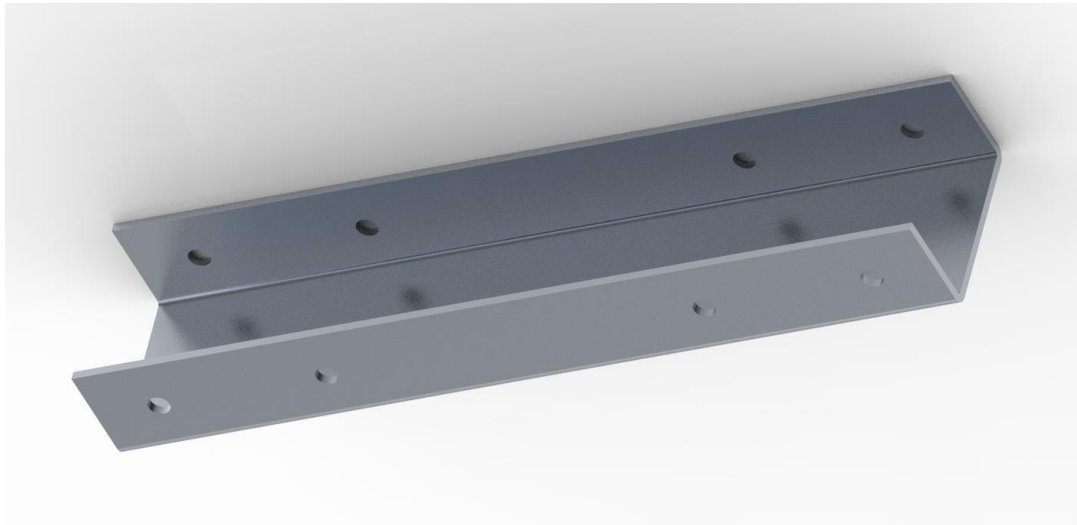

6.5.4 Laying modules

- Do not bend the module during installation. Two people should grasp the white edge of the module and place it onto the glue. Modules should be in a straight position during placement. Do not re-glue the modules.
- Once modules are placed, avoid hand-pressing the cell-area to facilitate adhesion. Instead use a compaction roller to press the edge (non-cell area) of the module down. Also use a Plastic roller to apply gentle force to the cell area to facilitate adhesion.
- The minimum distance between the modules is 5mm, and the distance between each array is 500-800mm, which is used as a construction maintenance walkway. (This spacing is for reference only)
- Adjacent modules can share the same Aluminum support rail.
- Place the junction box on the maintenance walkway side for easy string wiring and maintenance inspection.
- Follow the steps above to install the other modules.

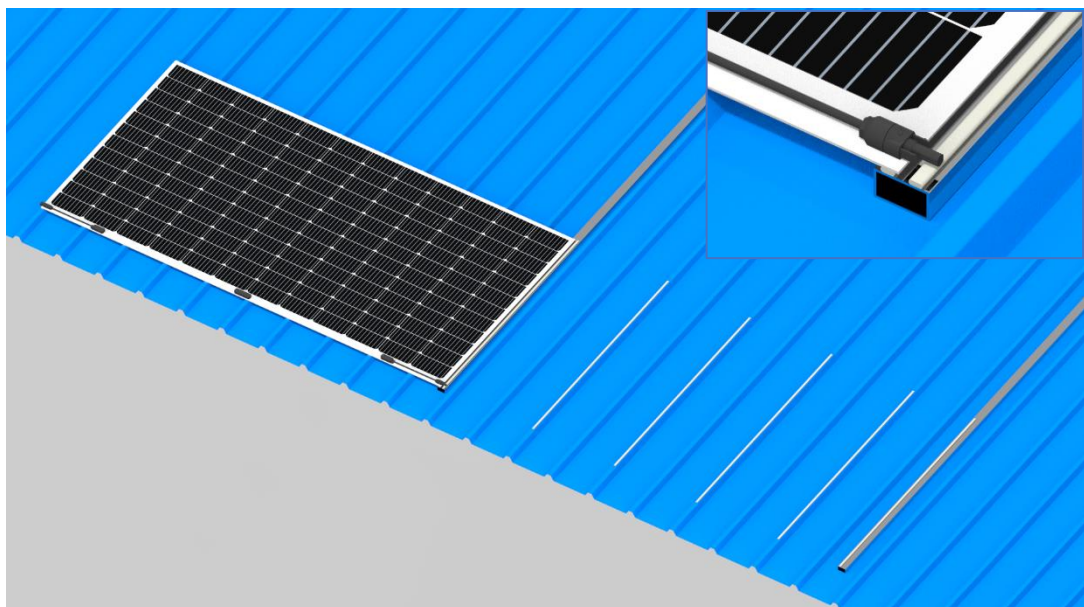
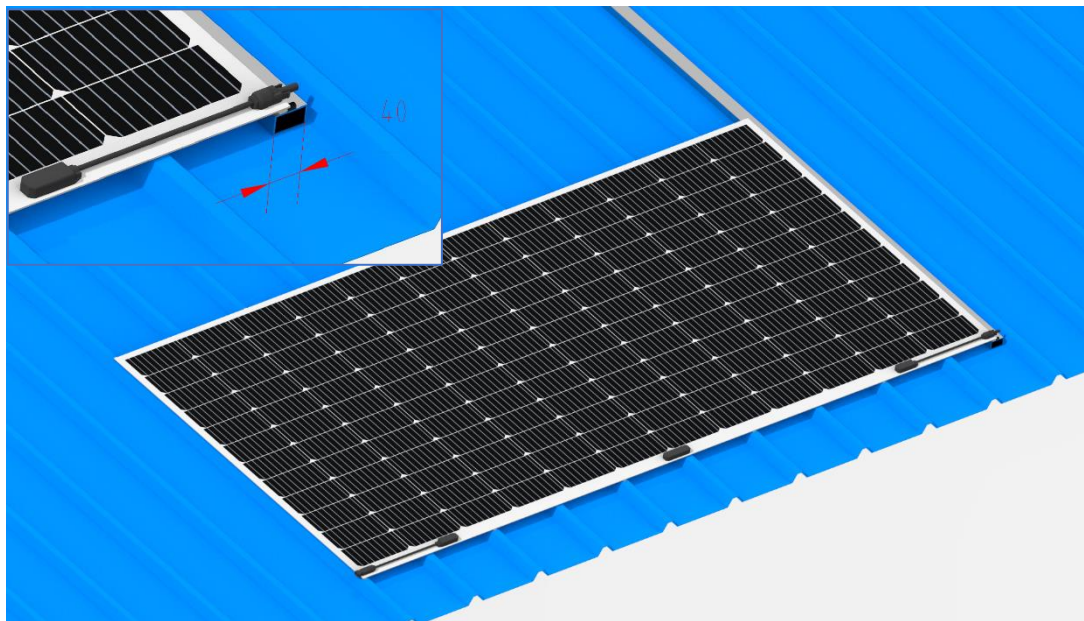

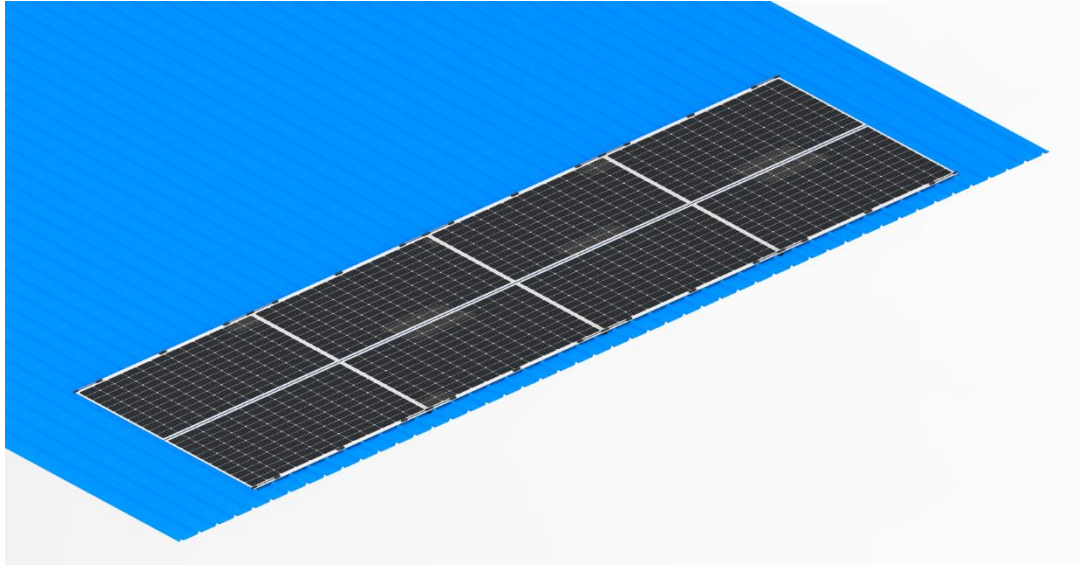

6.6 Wiring and testing

- 1) The use of PV modules with different configurations in a PV system is prohibited.
- 2) Excessive cables must be organized or fixed in the proper location.
- 3) For applications requiring high operating voltages, several PV modules may be connected in series to form a PV string, then the system voltage is equal to the sum of the voltages of each PV module
- 4) For applications requiring high operating currents, several strings of PV modules can be connected in parallel to form a PV string, then the system current is equal to the sum of the currents of each PV module string.
- 5) A maximum system voltage of 1000VDC is allowed.
- 6) The maximum number of PV modules in series depends on the system design, the type of inverter used and the environmental conditions;
- 7) Depending on the maximum series fuse rating of the PV module and local electrical installation codes, if the PV module does not have any fuses or blocking diodes, make sure to connect no more than two strings in parallel;
- 8) There is no limit to the number of PV modules that can be connected in parallel (fuses per string should be considered), the number of PV modules is determined by system design parameters such as current or power output;
- 9) Please refer to local regulations to determine the size, type and temperature of the system conductors;
- 10) PV modules are equipped with connectors for system electrical connections,

please refer to local regulations and data sheets that allow the use of connectors;

- 11) To ensure a reliable electrical connection and to prevent possible moisture ingress, connectors must fit and lock together until a click is heard;

The DC power generated by the PV system can be converted to AC power and connected to the public grid, as the local power company's policy for connecting renewable energy systems to the grid varies from region to region. You can ask your PV system design engineer or integrator for help in obtaining building permits, inspections and approvals from your local power company's department.

7.0 Maintenance

To ensure optimal performance of modules and maximize system power generation, the following maintenance measures are recommended:

1 Module appearance inspection, focusing on the following points:

- a) Whether the module is damaged.
- b) Whether there is a sharp object touching the surface of the module.
- c) Whether the modules are obstructed by obstacles and objects, avoiding new trees, new poles etc. to shielding the modules.
- d) Check for corrosion near the busbar. This kind of corrosion is caused by the damage of the module surface during transportation, which causes moisture to penetrate into the interior of the module.
- e) Check the adhesive between the module and the roof for looseness or damage and adjust or repair it in time.

2 Clean the modules. The accumulation of dust or dirt on the surface of the modules will reduce the power output. It should be cleaned regularly to keep the surface clean. Generally, it should be cleaned at least once a month, appropriately increase the frequency in the harsh natural environment. Pay attention when cleaning PV modules:

- a) Rinse with water first, then dry the water with a soft cloth. Do not use corrosive solvents to clean or wipe the PV modules with hard objects.
- b) The PV module should be cleaned at an irradiance of less than 200 W/m². It should be cleaned in the absence of sunlight or in the morning and evening.
- c) It is strictly forbidden to clean PV modules under meteorological conditions where the wind is greater than grade 4, heavy rain or heavy snow.

Note: Do not walk, stand or sit on the module when cleaning.

3 Connector and cable inspection. It is recommended to conduct a preventive inspection every six months:

- a) Check for signs of aging of PV modules, including possible rodent damage, weathering, and whether all connectors are tightly connected or corroded.

Annex A

Electrical performance parameter

Series	Products	STC					module size
		Pmp	Vmp	Imp	Voc	Isc	
	SMF430F-12X12UW	430	42.0	10.24	49.8	10.74	2054*1084*2

Annex B

Cleaning agent

Roof type	Cleaning agent recommended by Sunman
TPO、PVC、Asphalt、EPDM、etc. plastic roof	Plastic cleaner China: RA-1033 Overseas: Use the cleaning agent recommended by the roofing material supplier
Color steel tile, glass roof, metal roof	90% isopropanol + 10% water

Use the cleaners listed above or those recommended by the roofing material supplier.



Annex C

Gluing operation specification

1. Gluing nozzle cutting

The standard nozzle cutout is 10.5mm x 6mm, which is made by cutting about 20mm from the original nozzle and flattening it to the required size, as shown in the figure below.

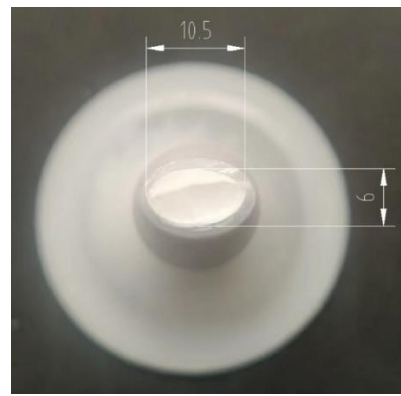

Nozzle cutting should be carried out in strict accordance with the following procedures.



Standard tool shears (complimentary with adhesive)

Operation steps



1. Use a straightedge or tape measure to measure the length of the head of the nozzle 20mm, confirm the cutting position, and then use the tool to cut in addition.



2. It is recommended to use a lighter to heat the tip of the rubber nozzle for about 2s to prevent it from springing back after being flattened.



3. Squeezing of the nozzle to the desired size using a flattening die of the tool shears.

2. Electric glue gun adjustment

Standard glue-out speed: Half turn of the speed knob, see the following figure:

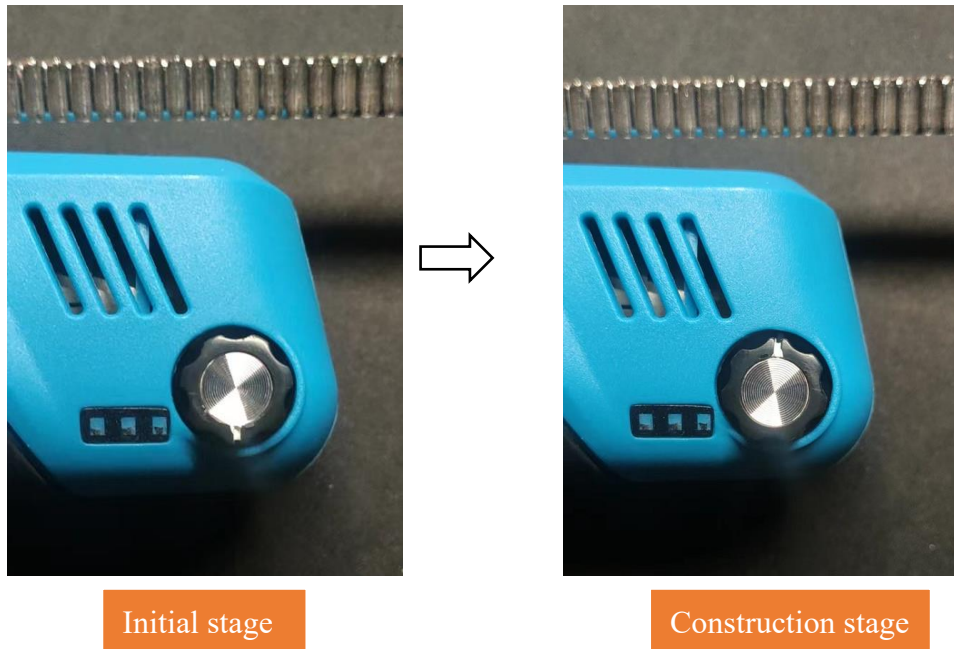

3. Gluing parameters

Gluing length: 10.8m/600ml on average

Gluing speed: about 10cm/s



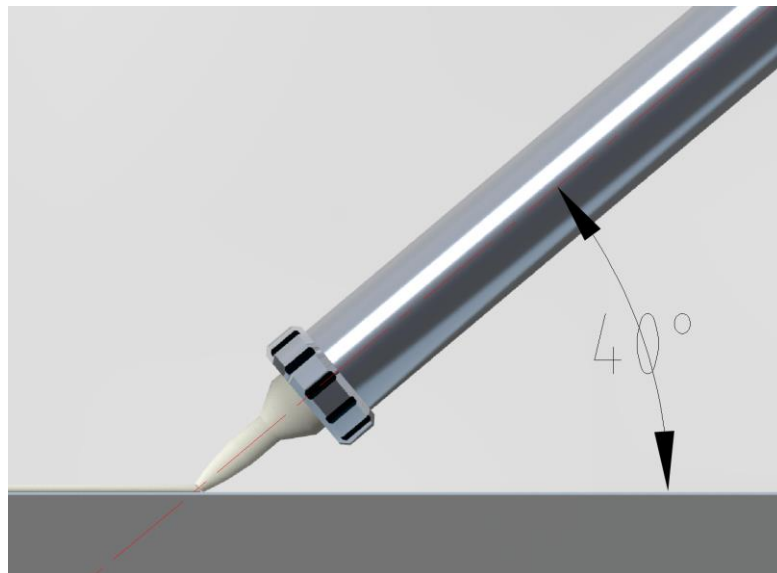





Gluing angle: the glue gun is at an angle of about 40° with the ground, as shown in the following figure:

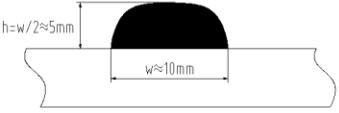





Adhesive size and standard dosage: at least 10*5mm; 5 strips/1 module (adhesive along the width of the PV module); 3 strips/1 module (adhesive along the length of the PV module)

4. Structural adhesive form

Please see below for proper bead application

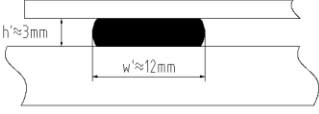
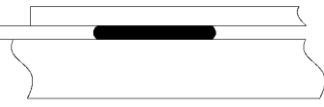
	
 Correct dimension	 Too flat
	
 Too high, too small	 Poor wetting

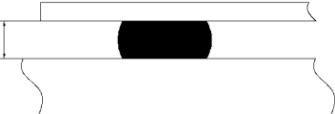
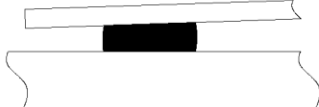
The correct form of structural adhesive after pasting modules

	
 Correct dimension	 Too flat
	
 Too high	 Inclined

Annex D

Unpacking

Standard unpacking steps for light weight PV modules.



1. Remove all wrapping film and packing tape outside the package



2. Remove packing box cover (keep well for another purpose)

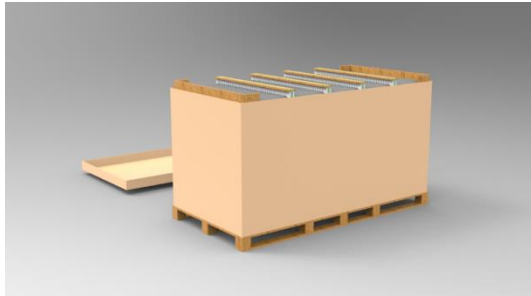

3. Place the cover next to the box with the opening up



4. Remove the outer packaging carton



4.1. Box cover retention (handling module auxiliary parts)



5. Remove the upper fence on the side of the wooden box, keep the lower fence



6. Use scissors or a hobby knife to cut off the packing tape used to secure the module (do not cut the module)

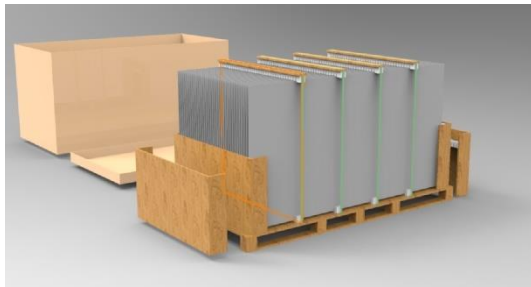

7. Remove the fixing clip above the module

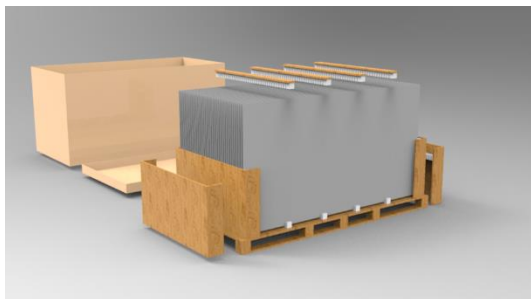
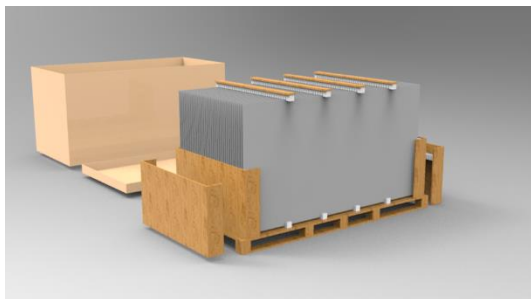

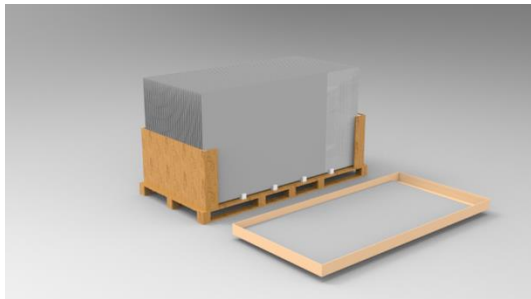
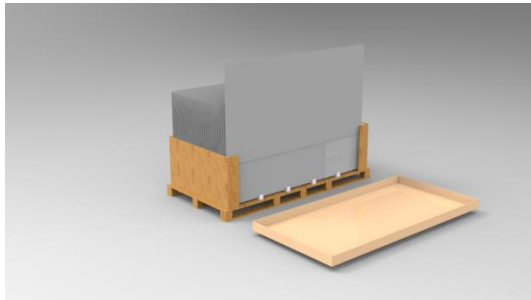
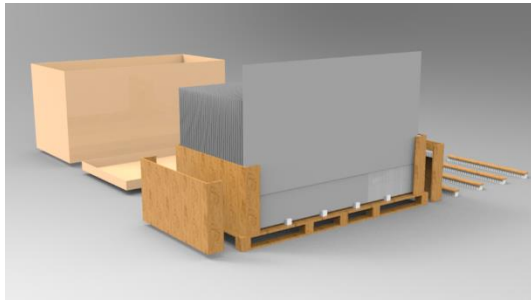
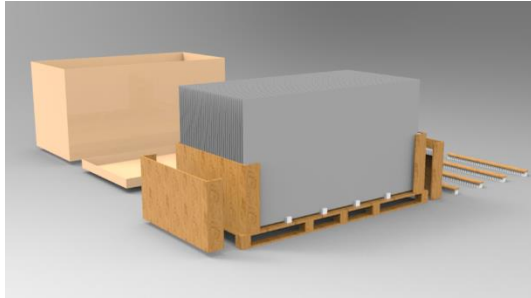

8、 To pick up the module, please raise the module to the height of the lower C-shaped enclosure and move out the module

When picking up the module, please grab the non-cell white area of the module.

When picking up the module, grab the long side direction of the module, the short side direction of the module can only be short grabbed again when out of the box operation

9、 Place the box cover open side up and transport the module flat inside the cover to the project designated installation site Place a maximum of two modules in the cover, separated from each other with foam inside the box

Use a minimum of four foam strands, placed evenly between the stacked modules.

Module stacking and handling operations are as follows:

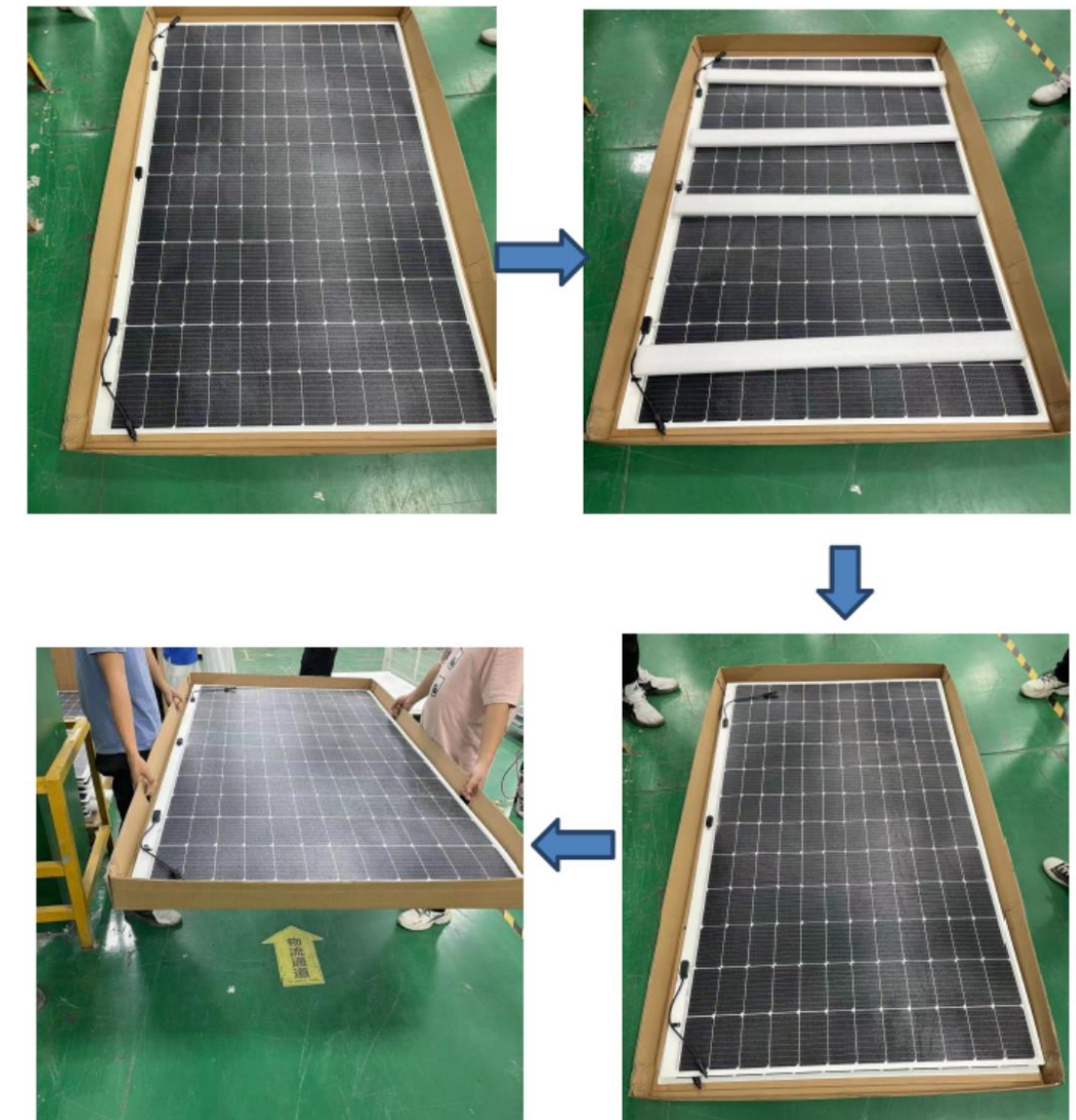

Unpacking precautions

Avoid operating in rainy weather when opening cartons outdoors.

Secure the modules when operating outdoors in windy conditions.

Stack components in a ventilated, rain-proof, and dry area before unpacking them.

Do not to damage the front or back of the module when using scissors or hobby knife to cut the outer packing tape.

Confirm the number of modules in the box promptly after unpacking.

The unpacking area needs to ensure that the box is placed horizontally and stably to avoid tipping of the modules.



During unpacking and handling, please wear protective gloves properly to avoid scratches.

Prohibit pulling on junction boxes or cables under any circumstances.

When handle the modules, avoid touching the cell area with hands.

eArc SMF
Installation Manual
for Flat Roofs with aluminum tube
Silicone

Contents

1.0 Summary.....	1
1.1 Disclaimer.....	1
1.2 Responsibility.....	1
1.3 Copyright and Trademark Information.....	1
1.4 Warranty Warnings.....	2
1.5 For Further Information.....	2
2.0 Safety precautions.....	2
3.0 Mechanical / electrical properties.....	4
4.0 Storage and unpacking.....	5
5.0 Installation.....	6
5.1 Module wiring.....	8
5.2 Grounding.....	8
6.0 Installation instructions.....	9
6.1 Module and tools.....	9
6.1.1 Module.....	9
6.1.2 Construction materials.....	9
6.2 Unpacking, Handling and Checking Precautions.....	10
6.3 Construction Precautions.....	11
6.4 Precautions and Tips for Gluing Modules.....	12
6.5 Construction plan.....	12
6.5.1 Cleaning the roof surface.....	12
6.5.2 Positioning and securing the line.....	13
6.5.3 Brush primer (ignore this step if no primer required for the roof material)	14
6.5.4 Paste rail.....	15
6.5.4 Laying modules.....	16
6.5.4 Joint of tubes.....	19

6.6 Wiring and testing	21
7.0 Maintenance	23
Annex A	24
Electrical performance parameter	24
Annex B	25
Installation for different roof materials	25
Annex C	26
Cleaning agent	26
Annex D	27
Gluing operation specification	27
1. Gluing nozzle cutting	27
2. Electric glue gun adjustment	28
3. Gluing parameters	29
4. Structural adhesive form	30
Annex E	31
Unpacking	31

1.0 Summary

Thank you for purchasing Sunman eArc PV modules. This guide contains information regarding the installation and safe handling of Sunman (Zhenjiang) Company Limited eArc SMF PV system on Roofs. Sunman (Zhenjiang) Company Limited referred to as “SUNMAN”. Users and installers must read and strictly follow the installation manual. Failure to follow these safety guidelines can result in personal injury or property damage. The installation and operation of solar modules require specialized skills, and only professionals can do the job. Please read the safety and installation instructions before using and operating the modules. The installer must inform the end customer (or consumer) of the above matters accordingly.

1.1 Disclaimer

Sunman reserves the right to change this installation manual without prior notice. The changes and the latest installation manuals after the changes will be published in the resource center of the official Sunman website. Customers should always pay attention to the above changes. Sunman will not provide further notice.

Failure in operating according to instructions in this manual during installation (Including the changes announced on the official website of Sunman at the time of installation) will cause the warranty to be invalid.

Sunman does not guarantee any expressed or implied information contained in this manual.

1.2 Responsibility

Whether or not the installation of the modules is carried out in accordance with the instructions in the installation manual (Including the changes announced on the official website of Sunman at the time of installation), Sunman shall not be held legally responsible for any damages incurred during the installation process, including but not limited to personal and property damage resulting from the operation of the modules and the installation of the system.

1.3 Copyright and Trademark Information

Copyright © 2023 by Sunman (Zhenjiang) Company Limited. All rights reserved. eArc and the SUNMAN logo are trademarks of Sunman (Zhenjiang) Company Limited.

1.4 Warranty Warnings

WARRANTY VOID IF NON-SUNMAN-CERTIFIED HARDWARE IS ATTACHED TO eArc™ PV System.

1.5 For Further Information

For additional technical support documentation, please visit the Support page of the SUNMAN website at ‘www.sunman-energy.com’.

2.0 Safety precautions



WARNING: Please read and understand all safety instructions before installing, wiring, operating, or maintaining modules. DC power is generated when the module is exposed to sunlight or other light sources. Direct contact with live parts of the module, such as terminals, whether connected or not, may result in personal injury or death.

Safety rules

- All installation work must be in full compliance with local regulations and corresponding national or international electrical standards.
- Use insulated tools to reduce the risk of electric shock.
- Use appropriate protective measures (slip gloves, overalls, etc.) to avoid direct contact with workers at 30V DC or higher, while avoiding direct contact with sharp edges during installation to protect the operator's hands.
- Do not wear metal ornaments when installing, to avoid puncturing the modules and causing electric shock.
- If modules are installed or operated on rainy days, strong winds or dew mornings, appropriate protective measures should be taken to avoid injury to modules and workers.
- Children or unauthorized personnel are not allowed to access the installation area or module storage area.
- If the circuit breaker and overcurrent protection circuit breaker cannot be opened, or if the inverter cannot be turned off during the module installation or wiring, cover the array modules with opaque material to stop the power output.

- Do not use or install damaged modules.
- If the module surface is damaged or worn, direct contact with the surface of the module may result in electric shock.
- Do not attempt to repair any part of the module, there are no user-accessible components within the module.
- The cover of the junction box should remain closed at all times.
- Do not split the modules or move any part of the module.
- Do not artificially condense light on modules.
- Do not connect or disconnect modules when there is current in the module or external current.

3.0 Mechanical / electrical properties

The rated electrical performance data for the modules is measured under standard test conditions (STC) of irradiance of 1000 W/m², AM 1.5, and cell temperature of 25 °C. The specific electrical and mechanical performance parameters of Sunman eArc modules are included in Annex A of this installation manual. The main electrical performance parameters under STC conditions are also marked on the nameplate of each module. The maximum system voltage for all modules is 1000V.

In some cases, the current or voltage generated by the module may be greater than the optimal operating current or voltage of its standard test condition (STC). Therefore, when determining the component rating and load value, the module open circuit voltage and short circuit current at STC should be multiplied by 1.25. Please check with your local rules and regulations.

4.0 Storage and unpacking

Precautions and general safety rules

- Store modules in a dry and ventilated environment.
- The modules must be transported in the package provided by Sunman and stored in the original package before installation. Please protect the packaging from damage. Open the package according to the recommended unpacking steps. Care must be taken during unpacking, shipping, and storage.
- Do not apply excessive loads on the modules or twist the modules.
- Do not carry the modules through the wires or junction boxes of the modules.
- Do not stand, climb, walk or jump on modules.
- Do not allow sharp objects to touch the modules. Scratches can directly affect the safety of the modules.
- Do not place the modules in an environment where there is no reliable support or is not fixed.
- Do not change the wiring method of the bypass diode.
- Keep all electrical connections clean and dry.

Product identification

- Barcode: each individual eArc has a unique serial number. The serial number has 21 digits. The 1st to 4th digits are the module type for internal use, and 5th to 8th digits are the year code, and the 9th and 10th digits are the month code, and the 11th and the 12th digits are the week code, and the 13th and 14th digits are the month code, and the 15th to 17th digits are order number, and the 18th to 21th digits are the sequence codes. For example, xxxx20210415xxxxxxxx means the module was made in the 15th week of 2021. Each module has only one bar code. It is permanently attached to the interior of eArc and is visible from the top front of eArc. This bar code is inserted prior to lamination.



- There is a nameplate, which shows the model number, main electrical properties, safety specifications and certification indicator, on the back of each module.

5.0 Installation

Precautions and general safety rules

- Before installing the modules, please contact the relevant department to obtain information about the installation site and the construction permit, and also comply with the installation and inspection requirements.
- Check the applicable building codes to ensure that the building to be installed and its structure (roof, facade, load-bearing, etc.) has sufficient load-bearing capacity.
- During installation, make sure that the modules are installed on a fire-resistant roof. According to UL790 standards, Sunman eArc modules are rated as fire rating C.
- The eArc modules are compliant with application level A (equivalent to safety level II, IEC 61730-1). This type of modules can be used in systems where the public is likely to come into contact with voltages greater than 50V or power greater than 240W.

Environmental conditions

The modules are suitable for general climatic conditions, ie with reference to IEC 60721-2-1- Classification of environmental conditions Part 2-1: Environmental conditions occurring in nature - temperature and humidity.

- If the modules are used in a special installation environment, please consult the technical support department of Sunman in advance.
- The installation surface should be flat without bumps or pits.
- The modules must not be installed near flames or flammable objects.
- Do not expose modules to artificial condensing light sources
- The modules should not be immersed in water (pure water or salt water), installed in long-term water environment (pure water or salt water) (eg fountains, sprays, etc.) or area prone to water accumulation (eg roof drain, low-lying areas, etc.).
- Please consult SMF installation manual for Flat roofs if roof area has poor drainage or extended water pooling.
- If the module is placed in a salt mist (ie marine environment) or in an environment containing sulfur (ie, sulfur sources, volcanoes, etc.), there is a risk of corrosion.

- **Failure to follow the above precautions, Sunman Warranty will be voided.**

Installation requirements

- Ensure the modules meet the overall technical requirements of the system.
- Ensure that components of other systems do not cause damaging mechanical or electrical performance effects on the modules.
- Connect modules in series to increase voltage or in parallel to increase current. When connected in series, the positive pole of the module is connected to the next negative pole. When connected in parallel, the positive pole of the module is connected to the positive pole of the next module.
- The number of bypass diodes provided varies depending on the module model.
- Connect the appropriate number of modules according to the voltage specifications of the inverter used in the system. Even at the lowest local temperature conditions, the connected modules must produce no more than the voltage allowed by the system. If overcurrent protection devices (fuse) are not used in series within each string of modules, up to two strings of modules can be connected in parallel. If a suitable overcurrent protection device is connected in series with each string of modules, three strings or more modules can be connected in parallel.
- In order to avoid (or reduce) the mismatch effect of the array, it is recommended to connect modules of similar electrical performance on the same string.
- In order to reduce the risk of indirect lightning strikes, loops should be avoided when designing the system.
- The modules should be securely fastened to withstand all possible loads, including wind and snow loads.

Optimal orientation and inclination

- In order to achieve maximum annual power generation, the optimal orientation and inclination of the PV module should be determined first. The maximum electrical energy is typically generated when sunlight is directed onto the PV module.

Avoid shadows

- Even small shadows (such as dust) can cause a drop in power generation. If all surfaces of the module are uncovered throughout the year, the module is considered "no shadow". Ensure that the sun shines on the modules even on

the shortest day of radiation all through the year.

- EVA aging caused by frequent occlusion of modules and long-term heating of the diode can affect the lifetime of the module.

5.1 Module wiring

Correct electrical wiring

- Check that the wiring is correct before starting the system. If the measured open circuit voltage (Voc) and short circuit current (Isc) do not match the specifications provided, there may be a wiring fault.

Correct connection of the MC4 connector

- Make sure the MC4 connector is secure and properly connected. The MC4 connector must not be subjected to external pressure. The MC4 connector can only be used for circuit connection functions and should not be used to turn the circuit on and off.
- The MC4 connector should be kept dry and clean to prevent rain and moisture. Avoid direct sunlight and water soaking of the MC4 connector.

Use appropriate materials

- Depending on local fire, construction and electrical standard, use dedicated solar cables and suitable MC4 connectors to ensure the electrical and mechanical performance of the cable.
- The solar cable licensed for use is a single-wire cable, 2.5-10mm² (8-14 AWG), 90°C grade, with appropriate insulation to withstand the maximum possible system open circuit voltage. The appropriate wire size needs to be chosen to reduce the voltage drop. The wire should be made of copper.

Cable protection

- Secure the cable to the mounting system with a cable tie that is UV resistant. Appropriate measures should be taken to protect the exposed cable from damage (eg. in a plastic sleeve with UV aging resistance). Avoid direct exposure of the cable to direct sunlight.

5.2 Grounding

- With adhesive on the back of SMF modules, there is no metal conductor for the module, so no grounding of module is required.

6.0 Installation instructions

6.1 Module and tools

6.1.1 Module

Applicable module model: SMF430F-12X12UW, SMF430F-6X24UW

The electrical performance parameters are detailed in Annex A.

6.1.2 Construction materials

- Aluminum support rail, silicone sealant (glue), gluing gun, plastic roller, cleaning tool, tape measure, thread release tool, etc.
- Aluminum support rail

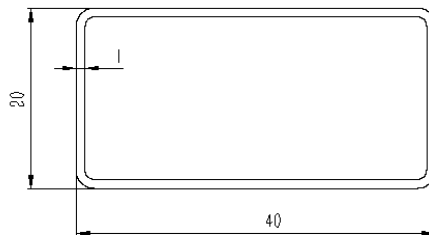

The material is 6063-T5/T6.

The dimension of support rail is 40x20x1 mm



Silicone sealant

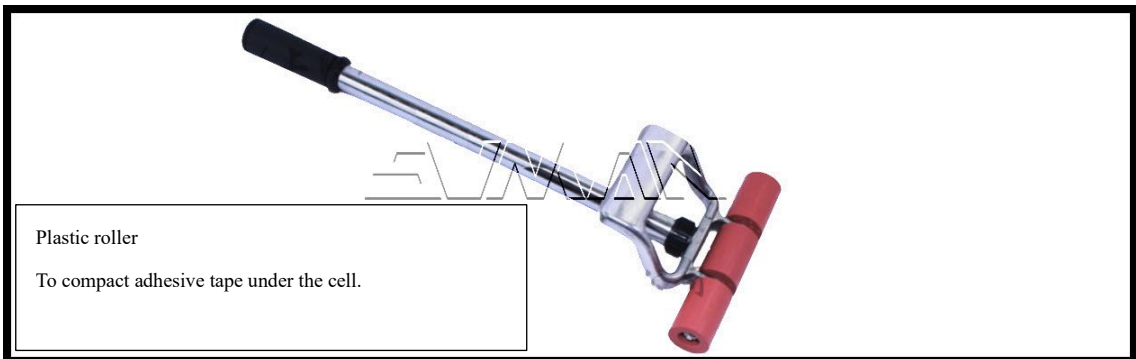

6.2 Unpacking, Handling and Checking Precautions

- Do not open modules outer Package before installation.
- Check the outer package for damage before unpacking.

- Slip-Proof Gloves are recommended for unpacking and handling.
- Do not grab the modules by the junction box or cables during unpacking or handling.
- Modules should be handled and lifted by at least two people. Do not touch the solar cell area during handling to avoid cell-cracks.
- Be careful while carrying the modules. Avoid hitting the modules on the ground or other sharp, hard objects. Scratches will affect the module's safe operation.
- Check the surfaces of the modules, make sure there's no damage to the frontsheet and the backsheet.
- Check the junction box, connectors, and cables for any damage. Double check if the junction box cover is fixed securely.
- Do not paint or apply glue or label on the surface of the modules.

6.3 Construction Precautions

- Normal construction can be carried out in the temperature range of -10 to 45 Celsius degrees (5 to 40 Celsius degrees is the best), and the humidity is below 80 %rh.
- The surface of the roof must be cleaned or wiped dry, free of floating soil, oil, etc. In order to achieve the required adhesion, the roof shall be cleaned using the cleaning agent specified in Annex C or Sunman- approved cleaning agent.
- After initial installation, the panel and adhesion shall not be disturbed for 24 hours.
- The roof angle is within 45 degrees.
- The paste surface needs to be flat and free of pits or bumps.
- The height of the structural adhesive after pasting should not be less than 3mm.
- Support rail should be laid along the direction of the roof water flow, to ensure smooth drainage (preferred)
- When the laying direction of the support rail is perpendicular to the direction of the water flow, the rail and the roof should be pasted intermittently to ensure smooth drainage (not recommended)

6.4 Precautions and Tips for Gluing Modules

- Please make sure the surface is cleaned and there are no water pits before gluing;
- Glue along the middle line of the trapezoid or wave crest. Width of silicone glue strips should exceed 10 mm and height of the strips should exceed 5 mm
- Applying the silicone glue should be a continuous and even movement. Please use a roller to spread out the glue strips evenly. Do not smooth out the lines of glue to spread them out;
- Make sure to complete the gluing and mounting over a duration that does not exceed 5 minutes;
- Silicone sealant will cure to a depth of 2-3mm in 48 hours. Do NOT apply any force on the module before curing is complete;

6.5 Construction plan

Note: The installation steps are for TPO roofs, for reference only, different roof types can refer to this step for construction.

Installation steps

6.5.1 Cleaning the roof surface

Remove debris from the roof base and use a designated or approved cleaning agent (Annex C) to clean the roof. If the roof is very dirty, use a low-pressure water spray or power washer before using the cleaner. Optionally, use a mixture of 1/4 cup of trisodium phosphate, 1/2 cup of liquid cleaner and 5 gallons of water for cleaning.

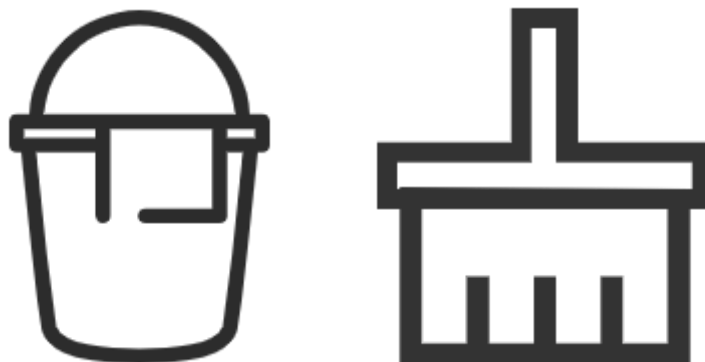

6.5.2 Positioning and securing the line



- Positioning and securing lines to determine the spacing of CS supports in accordance with the design drawings (For design drawings, please contact Sunman).





6.5.3 Brush primer (ignore this step if no primer required for the roof material)

- Determine the gluing area of the modules after the roof cleaning (refer to the design drawing for specific dimensions);



- Clean the gluing area again, wipe the area with the cleaning agent in Annex C;
- For the gluing area, brush primer before gluing to increase adhesion (see Annex B for different types of roof primer).



6.5.4 Paste rail

- Making Glue on the rail followed the Precautions and Tips for Gluing
- The two ends of a single module are continuously glued, and the middle adhesive area is glued sectionally. The glue length is 200mm. The sectional distance and glue length in middle can be adjusted according to the actual situation on site

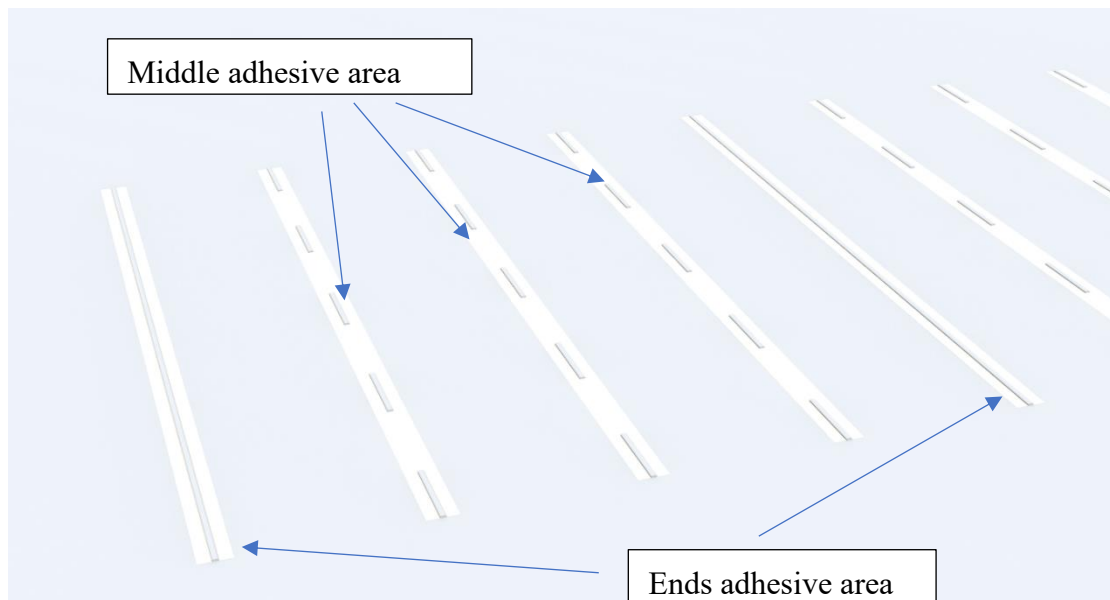

- Paste the rail along the gluing path, lightly compress, keep the glue thickness is not less than 3mm

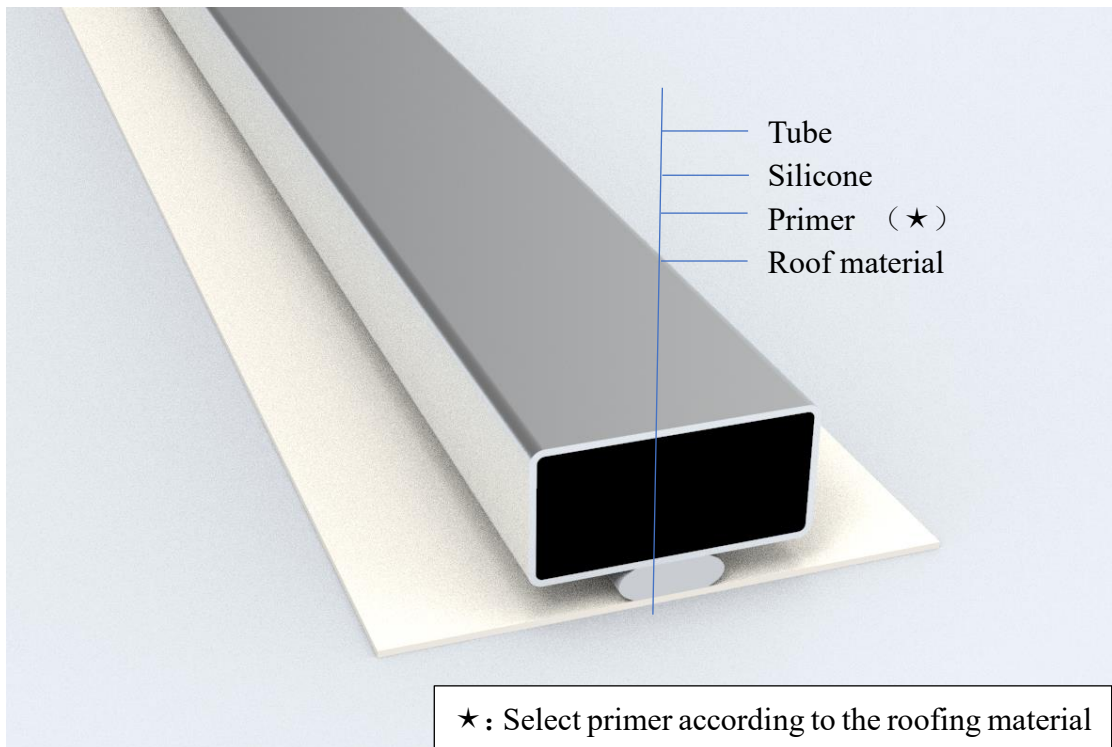

6.5.4 Laying modules

- Making Glue on the rail followed the Precautions and Tips for Gluing Modules;
- The two ends of a single module are continuously glued, and the middle adhesive area is glued sectionally. The glue length is 200mm. The sectional distance and glue length in middle can be adjusted according to the actual situation on site



- Do not bend the module during installation. Two people should grasp the white edge of the module and place it onto the glue. Modules should be in a straight position during placement. Do not re-glue the modules.
- Once modules are placed, avoid hand-pressing the cell-area to facilitate adhesion. Instead use a compaction roller to press the edge (non-cell area) of the module down. Also use a Plastic roller to apply gentle force to the cell area to facilitate adhesion.
- The minimum distance between the modules is 2mm, and the distance between each array is 500-800mm, which is used as a construction maintenance walkway. (refer to the pictures)
- If the module is selected as 12*12 series (the junction box is in the long side direction of the module), the junction box side should placed at the edge position for wiring and maintenance.
- Install remaining modules according to the preceding steps

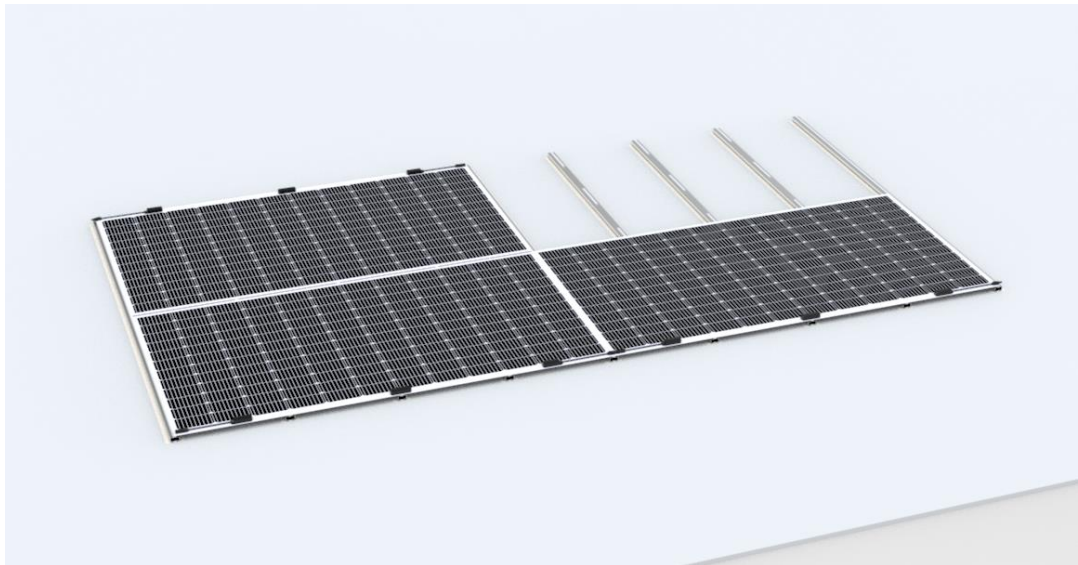
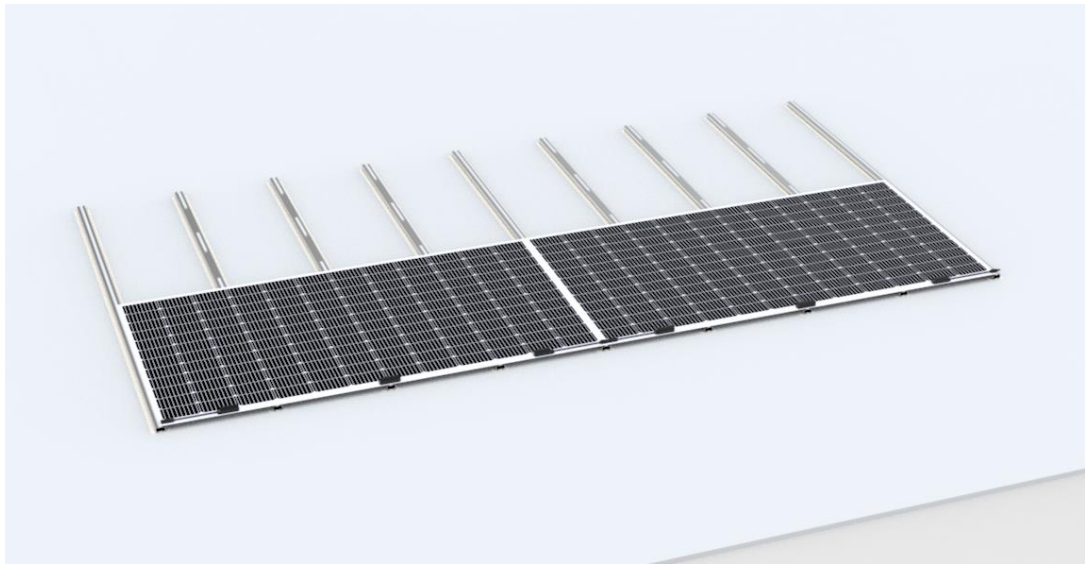

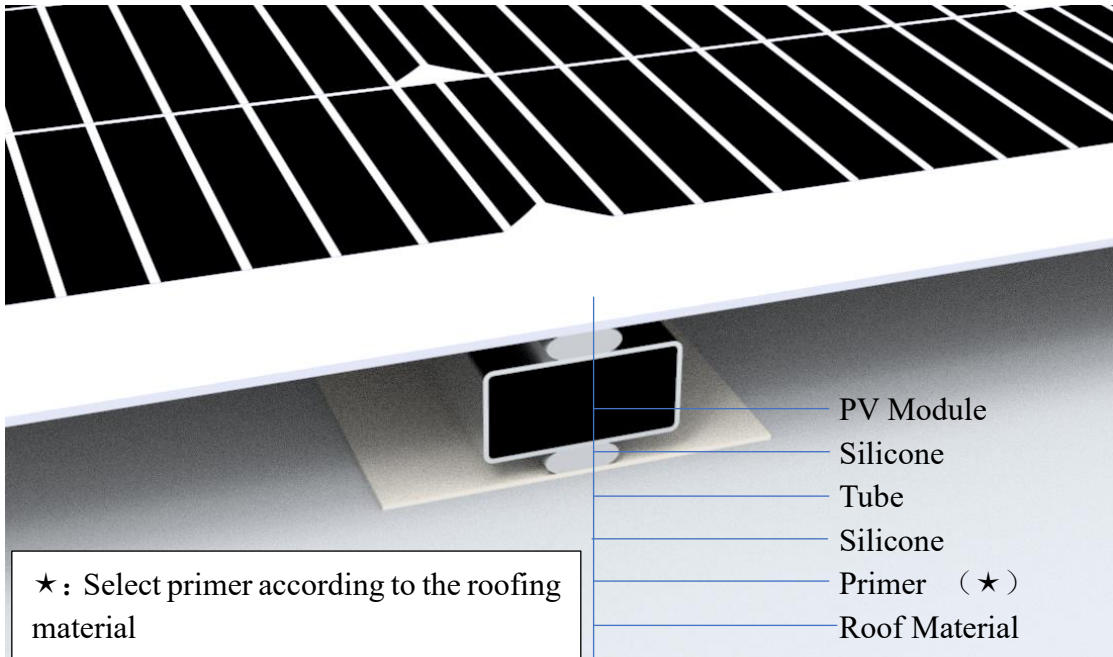

6.5.4 Joint of tubes

During the project installation process, the tubes need to be combined into a longer square tube, please strictly follow the following two methods to operate:

Method one: Put the joint between two modules

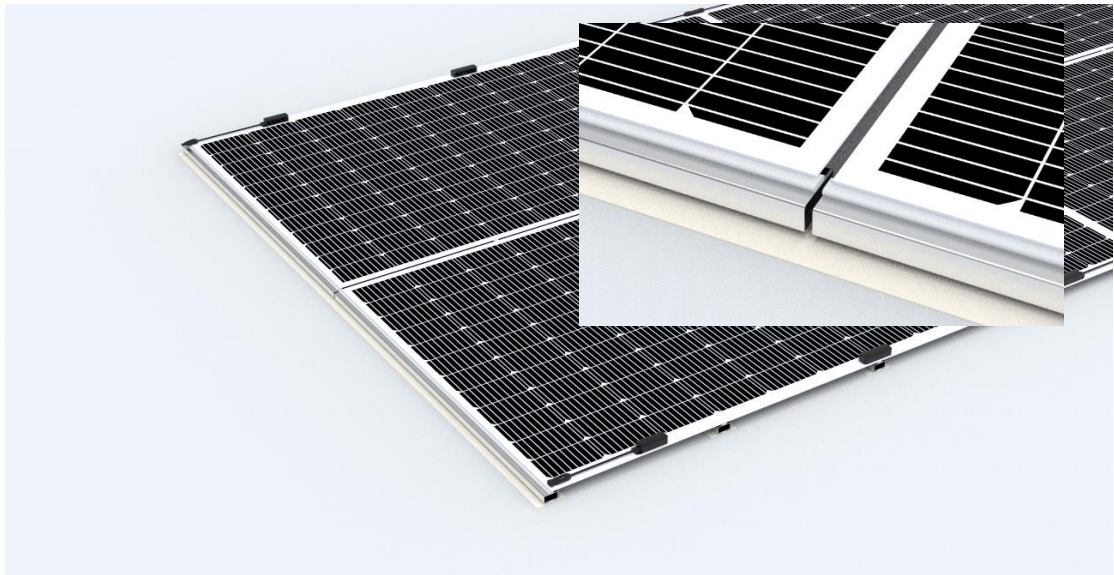

Method two: The joint be fixed with connectors and fasteners.

Connection style is for reference only, can be customized according to the actual situation of the project suitable for the connection

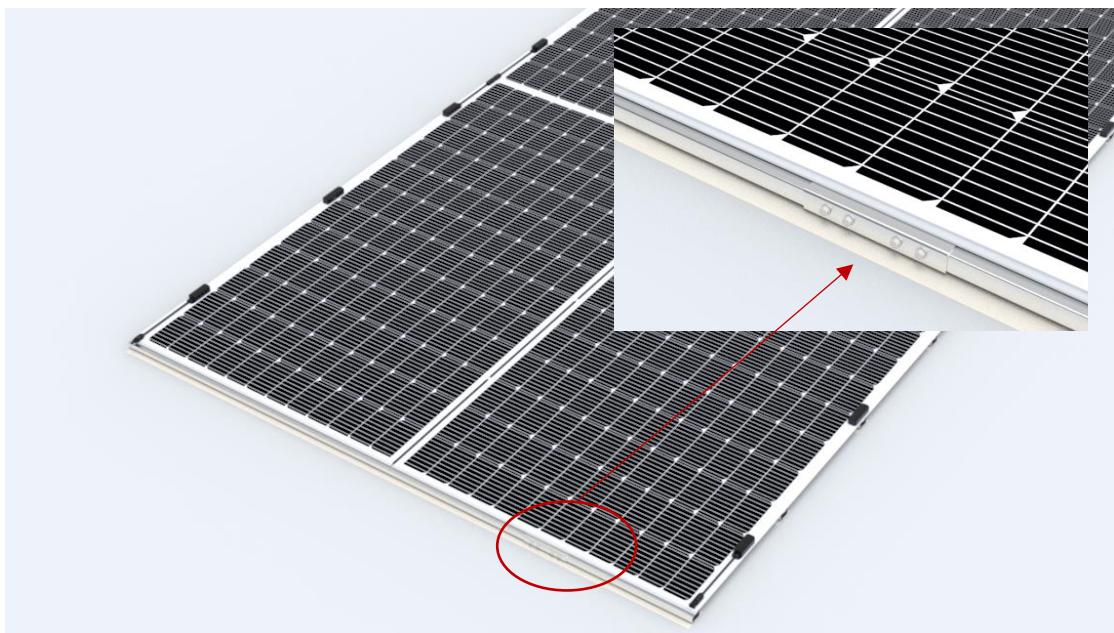

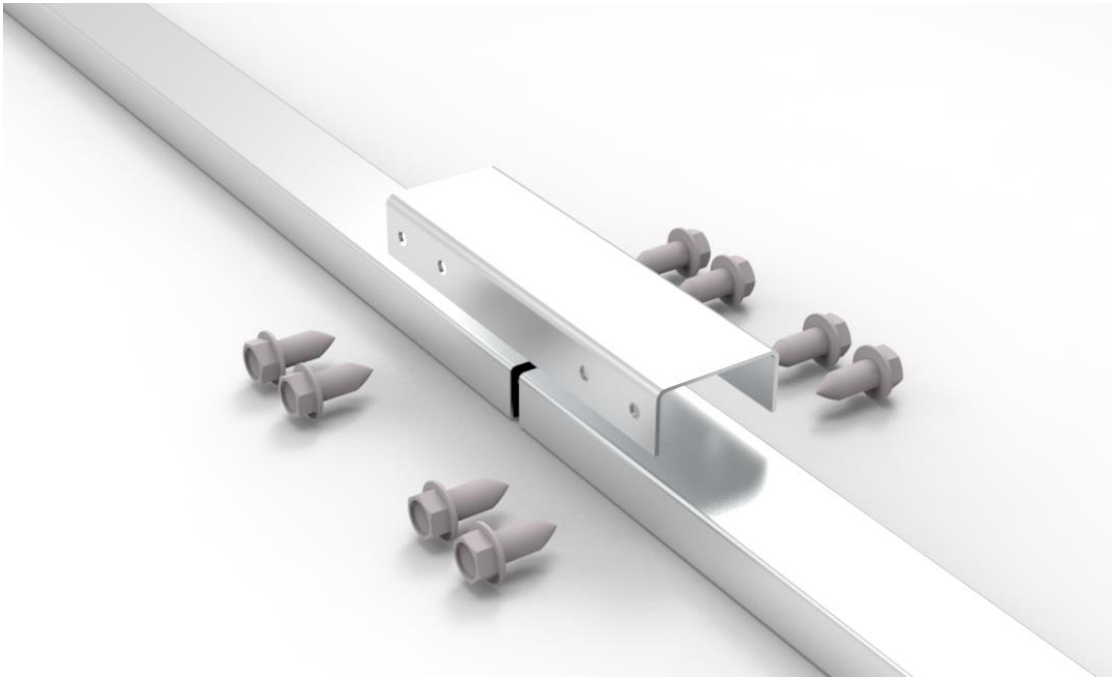

6.6 Wiring and testing

- 1) The use of PV modules with different configurations in a PV system is prohibited.
- 2) Excessive cables must be organized or fixed in the proper location.
- 3) For applications requiring high operating voltages, several PV modules may be connected in series to form a PV string, then the system voltage is equal to the sum of the voltages of each PV module
- 4) For applications requiring high operating currents, several strings of PV modules can be connected in parallel to form a PV string, then the system current is equal to the sum of the currents of each PV module string.
- 5) A maximum system voltage of 1000VDC is allowed.
- 6) The maximum number of PV modules in series depends on the system design, the type of inverter used and the environmental conditions;
- 7) Depending on the maximum series fuse rating of the PV module and local electrical installation codes, if the PV module does not have any fuses or blocking diodes, make sure to connect no more than two strings in parallel;
- 8) There is no limit to the number of PV modules that can be connected in parallel (fuses per string should be considered), the number of PV modules is determined by system design parameters such as current or power output;

- 9) Please refer to local regulations to determine the size, type and temperature of the system conductors;
- 10) PV modules are equipped with connectors for system electrical connections, please refer to local regulations and data sheets that allow the use of connectors;
- 11) To ensure a reliable electrical connection and to prevent possible moisture ingress, connectors must fit and lock together until a click is heard;

The DC power generated by the PV system can be converted to AC power and connected to the public grid, as the local power company's policy for connecting renewable energy systems to the grid varies from region to region. You can ask your PV system design engineer or integrator for help in obtaining building permits, inspections and approvals from your local power company's department.

7.0 Maintenance

To ensure optimal performance of modules and maximize system power generation, the following maintenance measures are recommended:

1 Module appearance inspection, focusing on the following points:

- a) Whether the module is damaged.
- b) Whether there is a sharp object touching the surface of the module.
- c) Whether the modules are obstructed by obstacles and objects, avoiding new trees, new poles etc. to shielding the modules.
- d) Check for corrosion near the busbar. This kind of corrosion is caused by the damage of the module surface during transportation, which causes moisture to penetrate into the interior of the module.
- e) Check the adhesive between the module and the roof for looseness or damage and adjust or repair it in time.

2 Clean the modules. The accumulation of dust or dirt on the surface of the modules will reduce the power output. It should be cleaned regularly to keep the surface clean. Generally, it should be cleaned at least once a month, appropriately increase the frequency in the harsh natural environment. Pay attention when cleaning PV modules:

- a) Rinse with water first, then dry the water with a soft cloth. Do not use corrosive solvents to clean or wipe the PV modules with hard objects.
- b) The PV module should be cleaned at an irradiance of less than 200 W/m^2 . It should be cleaned in the absence of sunlight or in the morning and evening.
- c) It is strictly forbidden to clean PV modules under meteorological conditions where the wind is greater than grade 4, heavy rain or heavy snow.

Note: Do not walk, stand or sit on the module when cleaning.

3 Connector and cable inspection. It is recommended to conduct a preventive inspection every six months:

- a) Check for signs of aging of PV modules, including possible rodent damage, weathering, and whether all connectors are tightly connected or corroded.

Annex A

Electrical performance parameter

Series	Products	STC					module size
		Pmp	Vmp	Imp	Voc	Isc	
	SMF430F-12X12UW	430	42.0	10.24	49.8	10.74	2054*1084*2
	SMF430F-6X24UW	430	42.0	10.24	49.8	10.74	2120*1046*2

Annex B

Installation for different roof materials

Roof type	Primer needed	Primer type	Silicone type
TPO	Yes	Contact Sunman	Tonsan 1527
Concrete	Yes	Contact Sunman	Tonsan 1527
Glass	No		Tonsan 1527
PVC	No		DIMA MS8201

Annex C

Cleaning agent

Roof type	Cleaning agent recommended by Sunman
TPO, PVC, Asphalt, EPDM, etc. plastic roof	Plastic cleaner China: RA-1033 Overseas: Use the cleaning agent recommended by the roofing material supplier
Color steel tile, glass roof, metal roof	90% isopropanol + 10% water

Use the cleaners listed above or those recommended by the roofing material supplier.



Annex D

Gluing operation specification

1. Gluing nozzle cutting

The standard nozzle cutout is 10.5mm x 6mm, which is made by cutting about 20mm from the original nozzle and flattening it to the required size, as shown in the figure below.

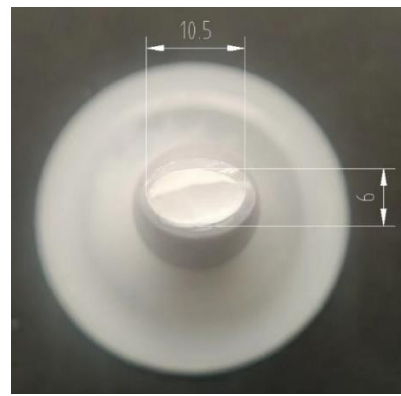

Nozzle cutting should be carried out in strict accordance with the following procedures.



Standard tool shears (complimentary with adhesive)

Operation steps

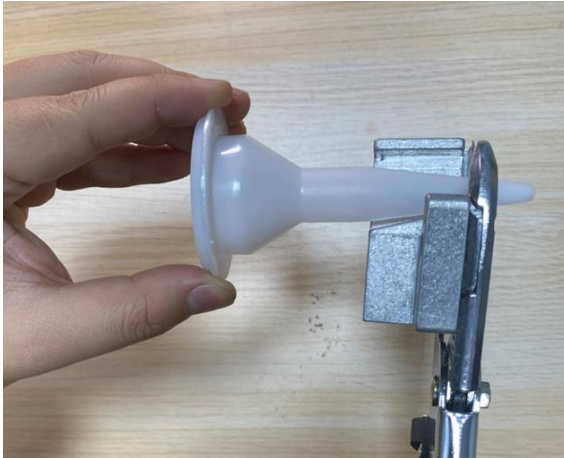

1. Use a straightedge or tape measure to measure the length of the head of the nozzle 20mm, confirm the cutting position, and then use the tool to cut in addition.



2. It is recommended to use a lighter to heat the tip of the rubber nozzle for about 2s to prevent it from springing back after being flattened.



3. Squeezing of the nozzle to the desired size using a flattening die of the tool shears.

2. Electric glue gun adjustment

Standard glue-out speed: Half turn of the speed knob, see the following figure:

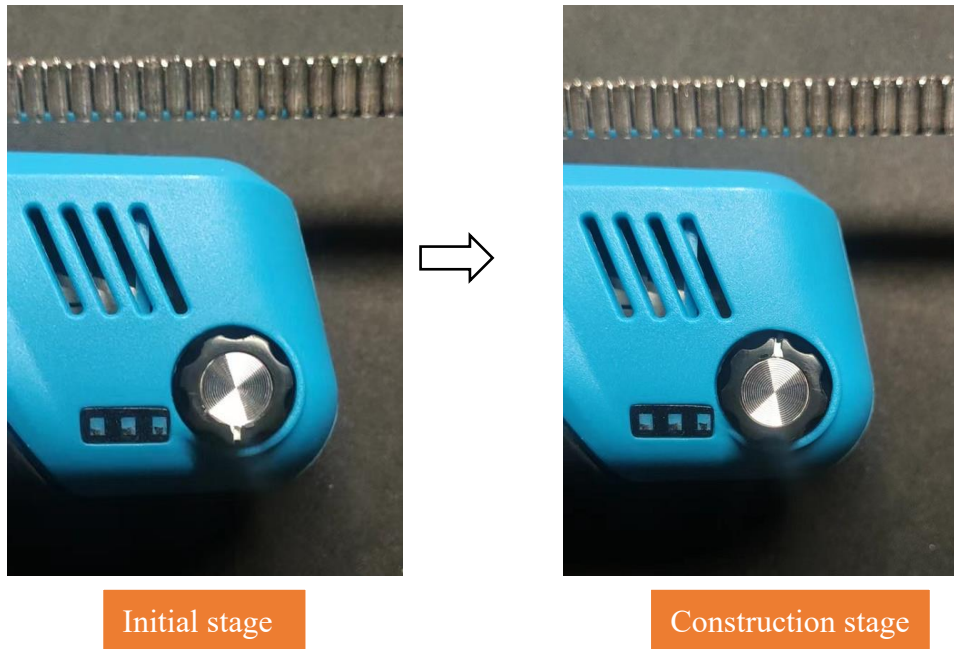

3. Gluing parameters

Gluing length: 10.8m/600ml on average

Gluing speed: about 10cm/s



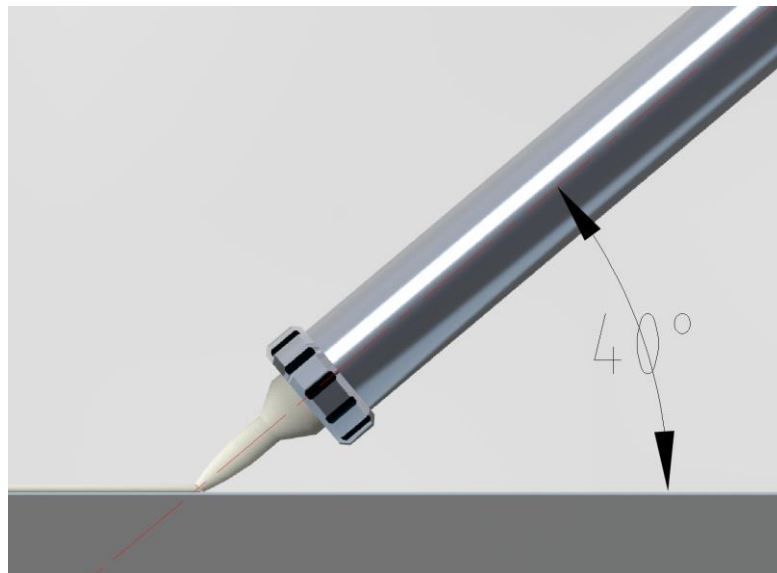



Gluing angle: the glue gun is at an angle of about 40° with the ground, as shown in the following figure:



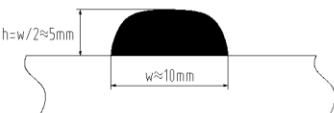

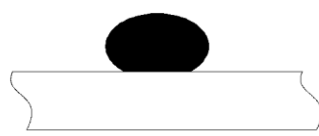

Adhesive size and standard dosage: at least 10*5mm; 5 strips/1 module (adhesive along the width of the PV module); 3 strips/1 module (adhesive along the length of the PV module)

4. Structural adhesive form

Please see below for proper bead application

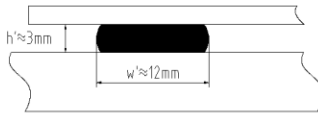
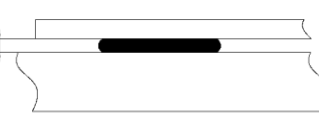
	
 Correct dimension	 Too flat
	
 Too high, too small	 Poor wetting

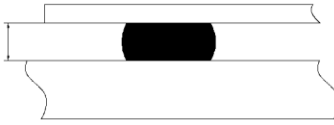
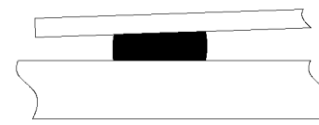
The correct form of structural adhesive after pasting modules

	
 Correct dimension	 Too flat
	
 Too high	 Inclined

Annex E

Unpacking

Standard unpacking steps for light weight PV modules.



1. Remove all wrapping film and packing tape outside the package



2. Remove packing box cover (keep well for another purpose)

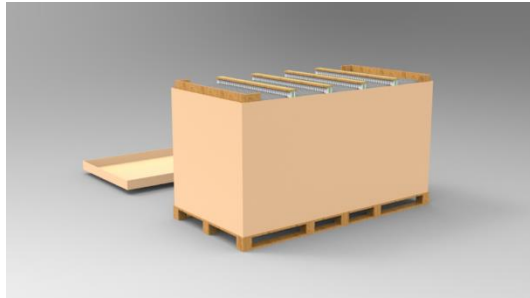

3. Place the cover next to the box with the opening up



4. Remove the outer packaging carton



4.1. Box cover retention (handling module auxiliary parts)



5. Remove the upper fence on the side of the wooden box, keep the lower fence

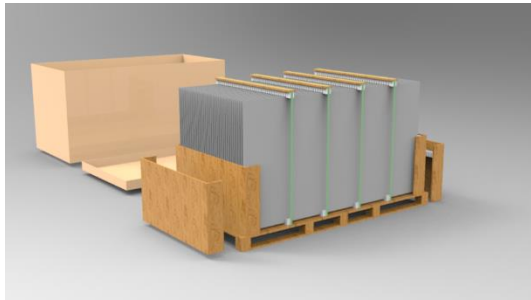

6. Use scissors or a hobby knife to cut off the packing tape used to secure the module (do not cut the module)

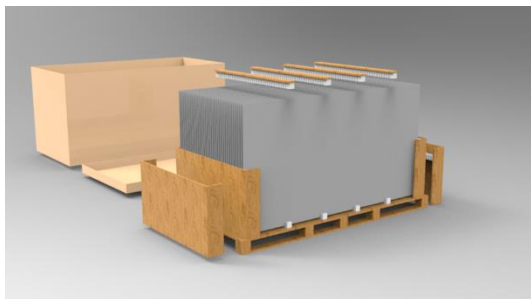
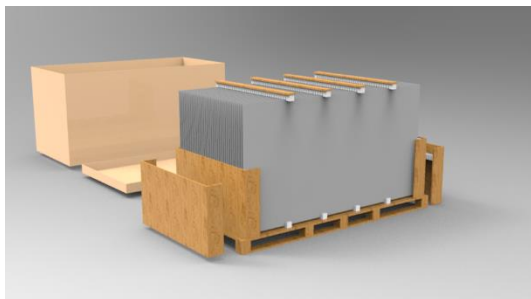

7. Remove the fixing clip above the module

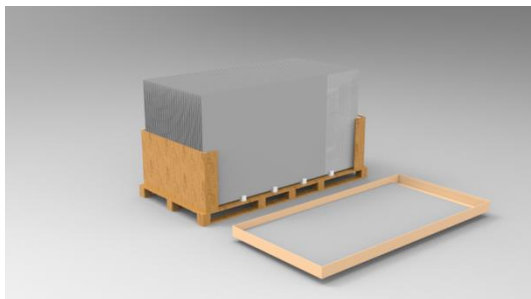
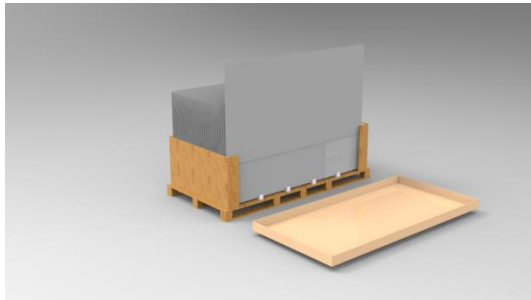
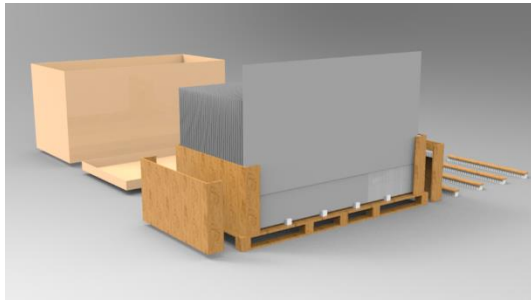
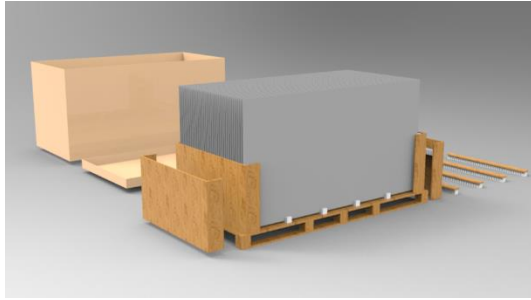

8、 To pick up the module, please raise the module to the height of the lower C-shaped enclosure and move out the module

When picking up the module, please grab the non-cell white area of the module.

When picking up the module, grab the long side direction of the module, the short side direction of the module can only be short grabbed again when out of the box operation

9、 Place the box cover open side up and transport the module flat inside the cover to the project designated installation site Place a maximum of two modules in the cover, separated from each other with foam inside the box

Use a minimum of four foam strands, placed evenly between the stacked modules.

Module stacking and handling operations are as follows:

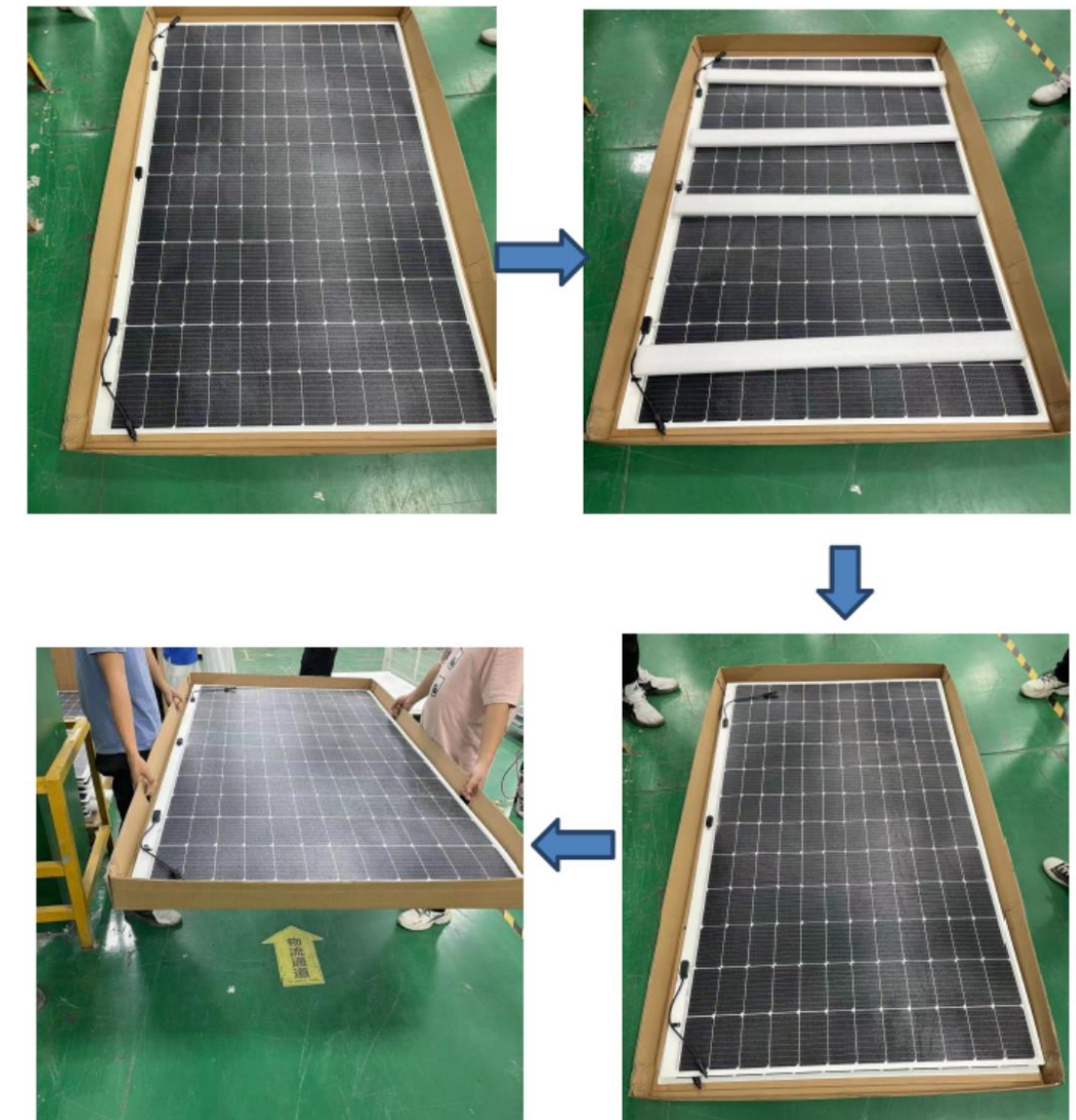

Unpacking precautions

Avoid operating in rainy weather when opening cartons outdoors.

Secure the modules when operating outdoors in windy conditions.

Stack components in a ventilated, rain-proof, and dry area before unpacking them.

Do not to damage the front or back of the module when using scissors or hobby knife to cut the outer packing tape.

Confirm the number of modules in the box promptly after unpacking.

The unpacking area needs to ensure that the box is placed horizontally and stably to avoid tipping of the modules.



During unpacking and handling, please wear protective gloves properly to avoid scratches.

Prohibit pulling on junction boxes or cables under any circumstances.

When handle the modules, avoid touching the cell area with hands.

eArc SMF
Installation Manual
for Flat Roofs with Aluminum tube
Tape

Contents

1.0 Summary.....	1
1.1 Disclaimer.....	1
1.2 Responsibility.....	1
1.3 Copyright and Trademark Information.....	1
1.4 Warranty Warnings.....	2
1.5 For Further Information.....	2
2.0 Safety precautions.....	2
3.0 Mechanical / electrical properties.....	4
4.0 Storage and unpacking.....	5
5.0 Installation.....	6
5.1 Module wiring.....	8
5.2 Grounding.....	8
6.0 Installation instructions.....	9
6.1 Module and tools.....	9
6.1.1 Module.....	9
6.1.2 Construction materials.....	9
6.1.2 Construction tools.....	9
6.2 Unpacking, Handling and Checking Precautions.....	10
6.3 Construction Precautions.....	11
6.4 Precautions and Tips for Gluing Modules.....	12
6.5 Construction plan.....	12
6.5.1 Cleaning the roof surface.....	12
6.5.2 Positioning and securing the line.....	13
6.5.3 Brush primer (ignore this step if no primer required for the roof material)	14
6.5.4 Paste tube.....	15
6.5.4 Laying modules.....	16

6.5.4 Joint of tubes	20
6.6 Wiring and testing	21
7.0 Maintenance	23
Annex A	24
Electrical performance parameter	24
Annex B	25
Installation for different roof materials	25
Annex C	26
Cleaning agent	26
Annex D	27
Gluing operation specification	27
1. Gluing nozzle cutting	27
2. Electric glue gun adjustment	28
3. Gluing parameters	29
4. Structural adhesive form	30
Annex E	31
Unpacking	31

1.0 Summary

Thank you for purchasing Sunman eArc PV modules. This guide contains information regarding the installation and safe handling of Sunman (Zhenjiang) Company Limited eArc SMF PV system on Roofs. Sunman (Zhenjiang) Company Limited referred to as “SUNMAN”. Users and installers must read and strictly follow the installation manual. Failure to follow these safety guidelines can result in personal injury or property damage. The installation and operation of solar modules require specialized skills, and only professionals can do the job. Please read the safety and installation instructions before using and operating the modules. The installer must inform the end customer (or consumer) of the above matters accordingly.

1.1 Disclaimer

Sunman reserves the right to change this installation manual without prior notice. The changes and the latest installation manuals after the changes will be published in the resource center of the official Sunman website. Customers should always pay attention to the above changes. Sunman will not provide further notice.

Failure in operating according to instructions in this manual during installation (Including the changes announced on the official website of Sunman at the time of installation) will cause the warranty to be invalid.

Sunman does not guarantee any expressed or implied information contained in this manual.

1.2 Responsibility

Whether or not the installation of the modules is carried out in accordance with the instructions in the installation manual (Including the changes announced on the official website of Sunman at the time of installation), Sunman shall not be held legally responsible for any damages incurred during the installation process, including but not limited to personal and property damage resulting from the operation of the modules and the installation of the system.

1.3 Copyright and Trademark Information

Copyright © 2023 by Sunman (Zhenjiang) Company Limited. All rights reserved. eArc and the SUNMAN logo are trademarks of Sunman (Zhenjiang) Company Limited.

1.4 Warranty Warnings

WARRANTY VOID IF NON-SUNMAN-CERTIFIED HARDWARE IS ATTACHED TO eArc™ PV System.

1.5 For Further Information

For additional technical support documentation, please visit the Support page of the SUNMAN website at ‘www.sunman-energy.com’.

2.0 Safety precautions



WARNING: Please read and understand all safety instructions before installing, wiring, operating, or maintaining modules. DC power is generated when the module is exposed to sunlight or other light sources. Direct contact with live parts of the module, such as terminals, whether connected or not, may result in personal injury or death.

Safety rules

- All installation work must be in full compliance with local regulations and corresponding national or international electrical standards.
- Use insulated tools to reduce the risk of electric shock.
- Use appropriate protective measures (slip gloves, overalls, etc.) to avoid direct contact with workers at 30V DC or higher, while avoiding direct contact with sharp edges during installation to protect the operator's hands.
- Do not wear metal ornaments when installing, to avoid puncturing the modules and causing electric shock.
- If modules are installed or operated on rainy days, strong winds or dew mornings, appropriate protective measures should be taken to avoid injury to modules and workers.
- Children or unauthorized personnel are not allowed to access the installation area or module storage area.
- If the circuit breaker and overcurrent protection circuit breaker cannot be opened, or if the inverter cannot be turned off during the module installation or wiring, cover the array modules with opaque material to stop the power output.

- Do not use or install damaged modules.
- If the module surface is damaged or worn, direct contact with the surface of the module may result in electric shock.
- Do not attempt to repair any part of the module, there are no user-accessible components within the module.
- The cover of the junction box should remain closed at all times.
- Do not split the modules or move any part of the module.
- Do not artificially condense light on modules.
- Do not connect or disconnect modules when there is current in the module or external current.

3.0 Mechanical / electrical properties

The rated electrical performance data for the modules is measured under standard test conditions (STC) of irradiance of 1000 W/m², AM 1.5, and cell temperature of 25 °C. The specific electrical and mechanical performance parameters of Sunman eArc modules are included in Annex A of this installation manual. The main electrical performance parameters under STC conditions are also marked on the nameplate of each module. The maximum system voltage for all modules is 1000V.

In some cases, the current or voltage generated by the module may be greater than the optimal operating current or voltage of its standard test condition (STC). Therefore, when determining the component rating and load value, the module open circuit voltage and short circuit current at STC should be multiplied by 1.25. Please check with your local rules and regulations.

4.0 Storage and unpacking

Precautions and general safety rules

- Store modules in a dry and ventilated environment.
- The modules must be transported in the package provided by Sunman and stored in the original package before installation. Please protect the packaging from damage. Open the package according to the recommended unpacking steps. Care must be taken during unpacking, shipping, and storage.
- Do not apply excessive loads on the modules or twist the modules.
- Do not carry the modules through the wires or junction boxes of the modules.
- Do not stand, climb, walk or jump on modules.
- Do not allow sharp objects to touch the modules. Scratches can directly affect the safety of the modules.
- Do not place the modules in an environment where there is no reliable support or is not fixed.
- Do not change the wiring method of the bypass diode.
- Keep all electrical connections clean and dry.

Product identification

- Barcode: each individual eArc has a unique serial number. The serial number has 21 digits. The 1st to 4th digits are the module type for internal use, and 5th to 8th digits are the year code, and the 9th and 10th digits are the month code, and the 11th and the 12th digits are the week code, and the 13th and 14th digits are the month code, and the 15th to 17th digits are order number, and the 18th to 21th digits are the sequence codes. For example, xxxx20210415xxxxxxxx means the module was made in the 15th week of 2021. Each module has only one bar code. It is permanently attached to the interior of eArc and is visible from the top front of eArc. This bar code is inserted prior to lamination.



- There is a nameplate, which shows the model number, main electrical properties, safety specifications and certification indicator, on the back of each module.

5.0 Installation

Precautions and general safety rules

- Before installing the modules, please contact the relevant department to obtain information about the installation site and the construction permit, and also comply with the installation and inspection requirements.
- Check the applicable building codes to ensure that the building to be installed and its structure (roof, facade, load-bearing, etc.) has sufficient load-bearing capacity.
- During installation, make sure that the modules are installed on a fire-resistant roof. According to UL790 standards, Sunman eArc modules are rated as fire rating C.
- The eArc modules are compliant with application level A (equivalent to safety level II, IEC 61730-1). This type of modules can be used in systems where the public is likely to come into contact with voltages greater than 50V or power greater than 240W.

Environmental conditions

The modules are suitable for general climatic conditions, ie with reference to IEC 60721-2-1- Classification of environmental conditions Part 2-1: Environmental conditions occurring in nature - temperature and humidity.

- If the modules are used in a special installation environment, please consult the technical support department of Sunman in advance.
- The installation surface should be flat without bumps or pits.
- The modules must not be installed near flames or flammable objects.
- Do not expose modules to artificial condensing light sources
- The modules should not be immersed in water (pure water or salt water), installed in long-term water environment (pure water or salt water) (eg fountains, sprays, etc.) or area prone to water accumulation (eg roof drain, low-lying areas, etc.).
- Please consult SMF installation manual for Flat roofs if roof area has poor drainage or extended water pooling.
- If the module is placed in a salt mist (ie marine environment) or in an environment containing sulfur (ie, sulfur sources, volcanoes, etc.), there is a risk of corrosion.

- **Failure to follow the above precautions, Sunman Warranty will be voided.**

Installation requirements

- Ensure the modules meet the overall technical requirements of the system.
- Ensure that components of other systems do not cause damaging mechanical or electrical performance effects on the modules.
- Connect modules in series to increase voltage or in parallel to increase current. When connected in series, the positive pole of the module is connected to the next negative pole. When connected in parallel, the positive pole of the module is connected to the positive pole of the next module.
- The number of bypass diodes provided varies depending on the module model.
- Connect the appropriate number of modules according to the voltage specifications of the inverter used in the system. Even at the lowest local temperature conditions, the connected modules must produce no more than the voltage allowed by the system. If overcurrent protection devices (fuse) are not used in series within each string of modules, up to two strings of modules can be connected in parallel. If a suitable overcurrent protection device is connected in series with each string of modules, three strings or more modules can be connected in parallel.
- In order to avoid (or reduce) the mismatch effect of the array, it is recommended to connect modules of similar electrical performance on the same string.
- In order to reduce the risk of indirect lightning strikes, loops should be avoided when designing the system.
- The modules should be securely fastened to withstand all possible loads, including wind and snow loads.

Optimal orientation and inclination

- In order to achieve maximum annual power generation, the optimal orientation and inclination of the PV module should be determined first. The maximum electrical energy is typically generated when sunlight is directed onto the PV module.

Avoid shadows

- Even small shadows (such as dust) can cause a drop in power generation. If all surfaces of the module are uncovered throughout the year, the module is considered "no shadow". Ensure that the sun shines on the modules even on

the shortest day of radiation all through the year.

- EVA aging caused by frequent occlusion of modules and long-term heating of the diode can affect the lifetime of the module.

5.1 Module wiring

Correct electrical wiring

- Check that the wiring is correct before starting the system. If the measured open circuit voltage (Voc) and short circuit current (Isc) do not match the specifications provided, there may be a wiring fault.

Correct connection of the MC4 connector

- Make sure the MC4 connector is secure and properly connected. The MC4 connector must not be subjected to external pressure. The MC4 connector can only be used for circuit connection functions and should not be used to turn the circuit on and off.
- The MC4 connector should be kept dry and clean to prevent rain and moisture. Avoid direct sunlight and water soaking of the MC4 connector.

Use appropriate materials

- Depending on local fire, construction and electrical standard, use dedicated solar cables and suitable MC4 connectors to ensure the electrical and mechanical performance of the cable.
- The solar cable licensed for use is a single-wire cable, 2.5-10mm² (8-14 AWG), 90°C grade, with appropriate insulation to withstand the maximum possible system open circuit voltage. The appropriate wire size needs to be chosen to reduce the voltage drop. The wire should be made of copper.

Cable protection

- Secure the cable to the mounting system with a cable tie that is UV resistant. Appropriate measures should be taken to protect the exposed cable from damage (eg. in a plastic sleeve with UV aging resistance). Avoid direct exposure of the cable to direct sunlight.

5.2 Grounding

- With adhesive on the back of SMF modules, there is no metal conductor for the module, so no grounding of module is required.

6.0 Installation instructions

6.1 Module and tools

6.1.1 Module

Applicable module model: SMF430F-12X12UW, SMF430F-6X24UW

The electrical performance parameters are detailed in Annex A.

6.1.2 Construction materials

6.1.2 Construction tools

- Aluminum support rail, silicone sealant (glue), gluing gun, plastic roller, cleaning tool, tape measure, thread release tool, etc.
- **Aluminum support rail**

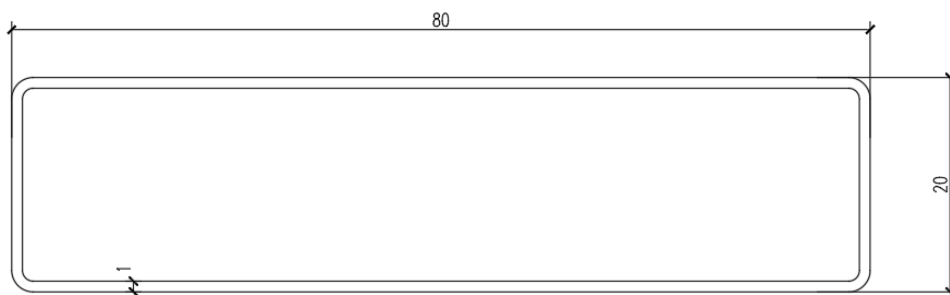

The material is 6063-T5/T6.

The dimension of support rail is 80x20x1 mm



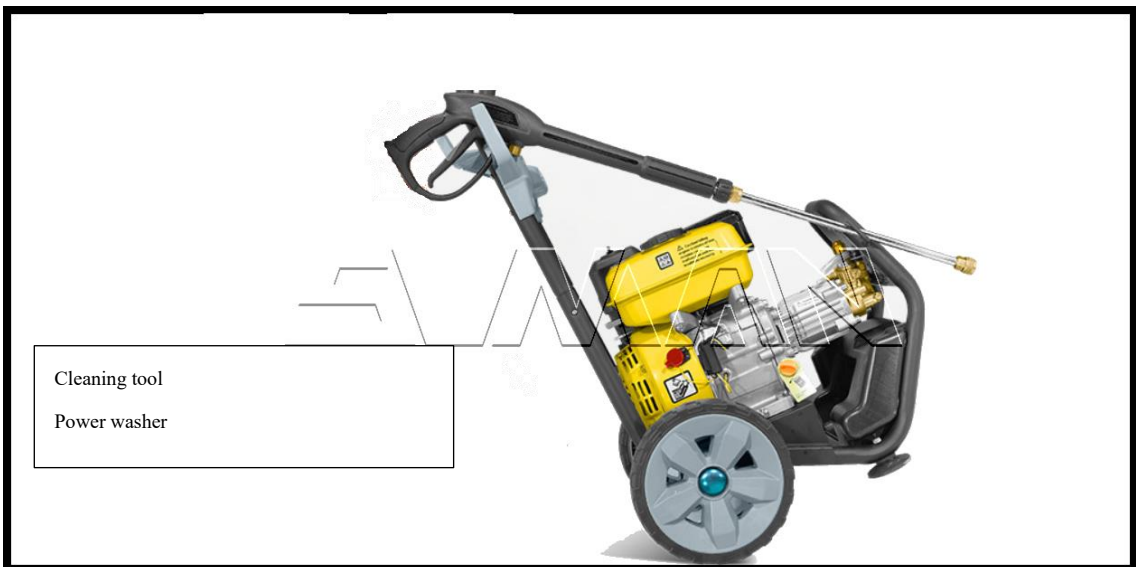
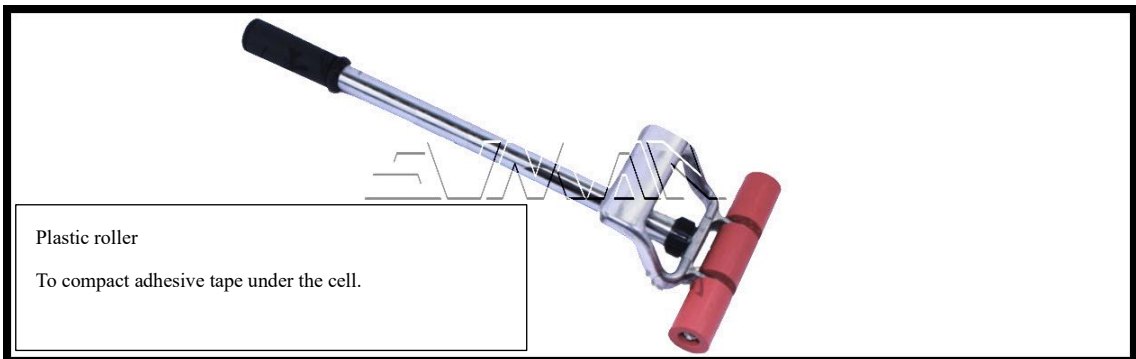

6.2 Unpacking, Handling and Checking Precautions

- Do not open modules outer Package before installation.
- Check the outer package for damage before unpacking.

- Slip-Proof Gloves are recommended for unpacking and handling.
- Do not grab the modules by the junction box or cables during unpacking or handling.
- Modules should be handled and lifted by at least two people. Do not touch the solar cell area during handling to avoid cell-cracks.
- Be careful while carrying the modules. Avoid hitting the modules on the ground or other sharp, hard objects. Scratches will affect the module's safe operation.
- Check the surfaces of the modules, make sure there's no damage to the frontsheet and the backsheet.
- Check the junction box, connectors, and cables for any damage. Double check if the junction box cover is fixed securely.
- Do not paint or apply glue or label on the surface of the modules.

6.3 Construction Precautions

- Normal construction can be carried out in the temperature range of -10 to 45 Celsius degrees (5 to 40 Celsius degrees is the best), and the humidity is below 80 %rh.
- The surface of the roof must be cleaned or wiped dry, free of floating soil, oil, etc. In order to achieve the required adhesion, the roof shall be cleaned using the cleaning agent specified in Annex C or Sunman- approved cleaning agent.
- After initial installation, the panel and adhesion shall not be disturbed for 24 hours.
- The roof angle is within 45 degrees.
- The paste surface needs to be flat and free of pits or bumps.
- The height of the structural adhesive after pasting should not be less than 3mm.
- Support rail should be laid along the direction of the roof water flow, to ensure smooth drainage (preferred)
- When the laying direction of the support rail is perpendicular to the direction of the water flow, the rail and the roof should be pasted intermittently to ensure smooth drainage (not recommended)

6.4 Precautions and Tips for Gluing Modules

- Please make sure the surface is cleaned and there are no water pits before gluing;
- Glue along the middle line of the trapezoid or wave crest. Width of silicone glue strips should exceed 10 mm and height of the strips should exceed 5 mm
- Applying the silicone glue should be a continuous and even movement. Please use a roller to spread out the glue strips evenly. Do not smooth out the lines of glue to spread them out;
- Make sure to complete the gluing and mounting over a duration that does not exceed 5 minutes;
- Silicone sealant will cure to a depth of 2-3mm in 48 hours. Do NOT apply any force on the module before curing is complete;

6.5 Construction plan

Note: The installation steps are for TPO roofs, for reference only, different roof types can refer to this step for construction.

Installation steps

6.5.1 Cleaning the roof surface

Remove debris from the roof base and use a designated or approved cleaning agent (Annex C) to clean the roof. If the roof is very dirty, use a low-pressure water spray or power washer before using the cleaner. Optionally, use a mixture of 1/4 cup of trisodium phosphate, 1/2 cup of liquid cleaner and 5 gallons of water for cleaning.

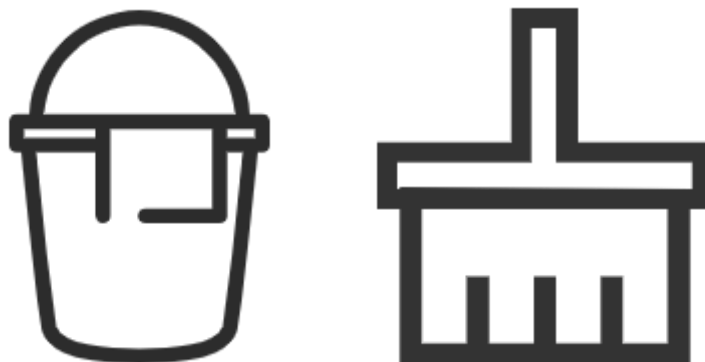

6.5.2 Positioning and securing the line



- Positioning and securing lines to determine the spacing of CS supports in accordance with the design drawings (For design drawings, please contact Sunman).





6.5.3 Brush primer (ignore this step if no primer required for the roof material)

- Determine the gluing area of the modules after the roof cleaning (refer to the design drawing for specific dimensions);

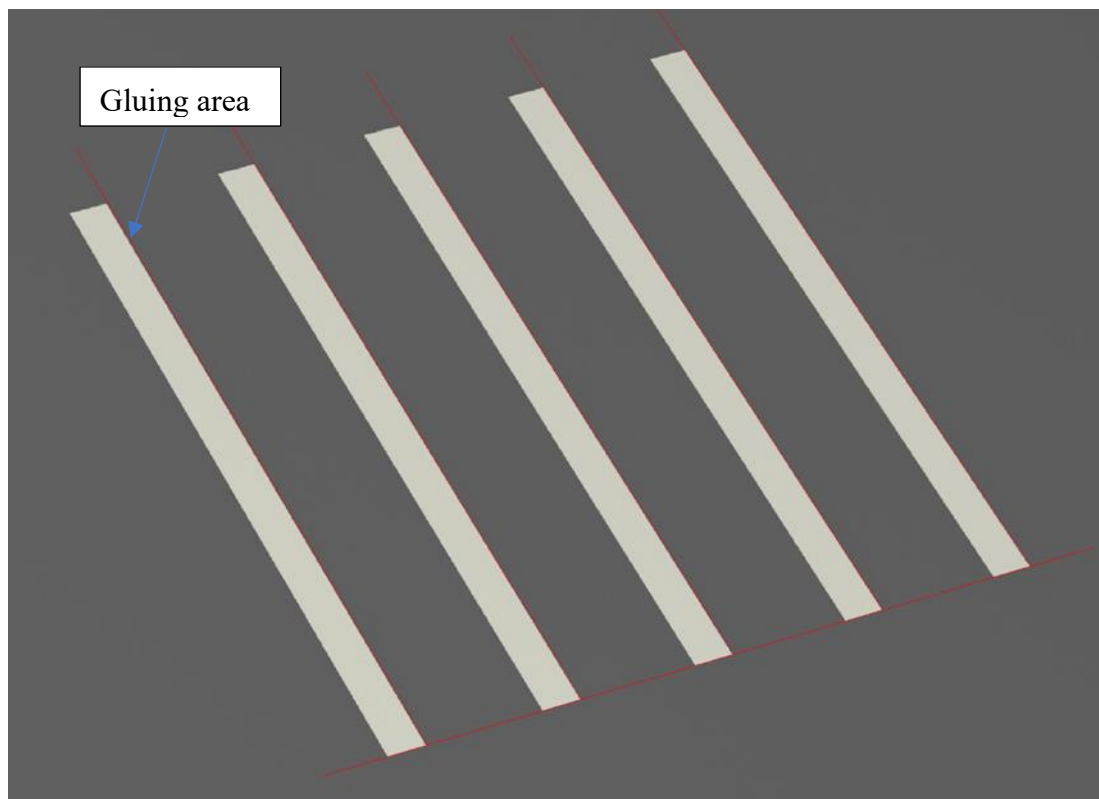

- Clean the gluing area again, wipe the area with the cleaning agent in Annex C;

- For the gluing area, brush primer before gluing to increase adhesion (see Annex B for different types of roof primer).

6.5.4 Paste tube

- Paste butyl tape, use a plastic roller to compress the tape to ensure the adhesive performance.

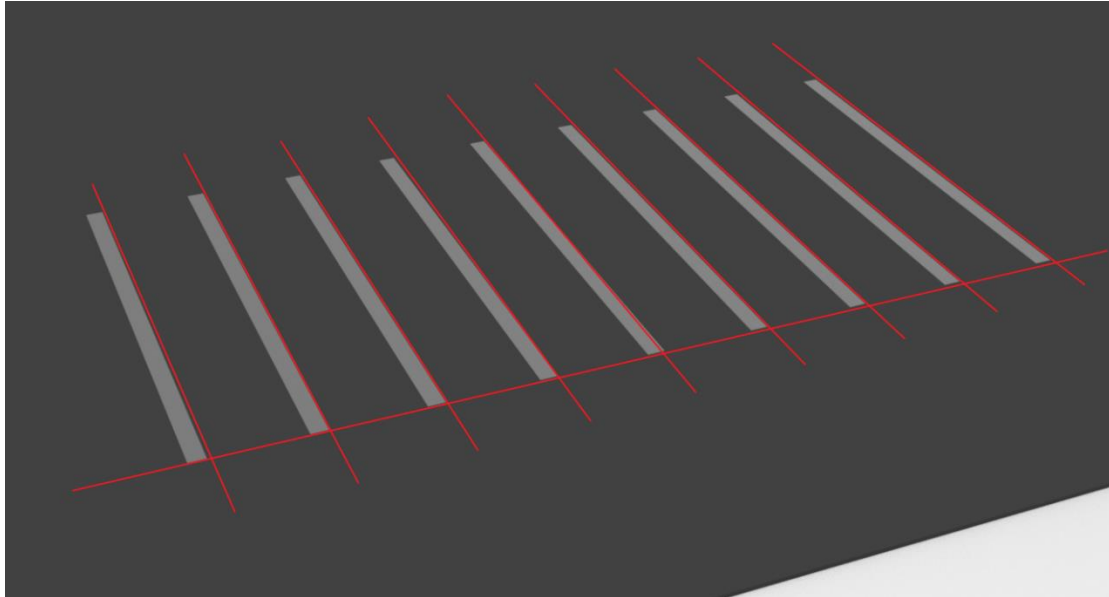

- Paste the tube on the butyl tape and ensure full contact with it.

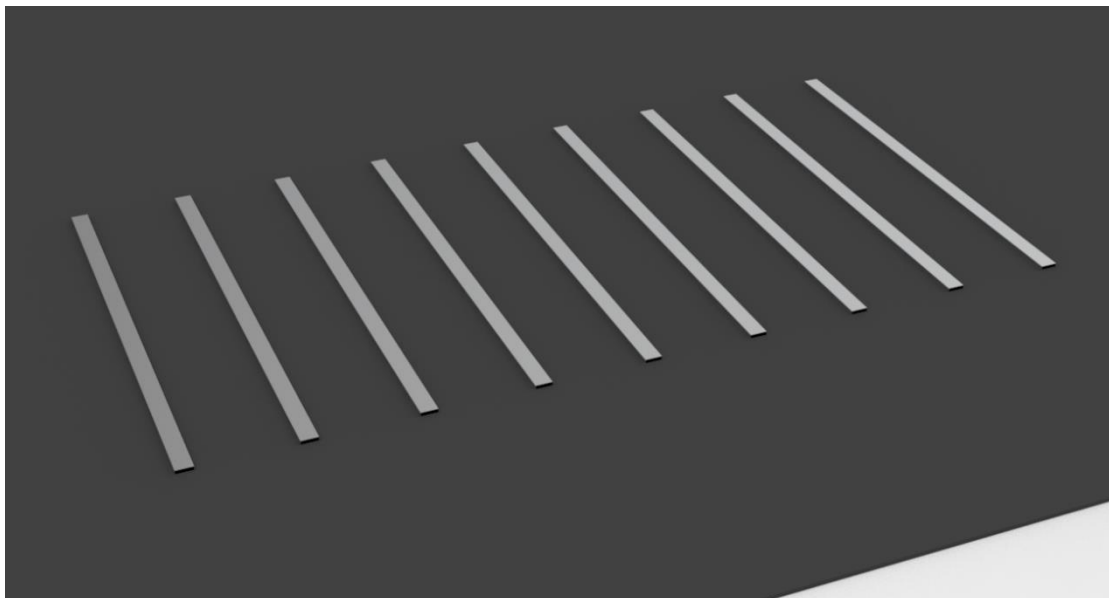

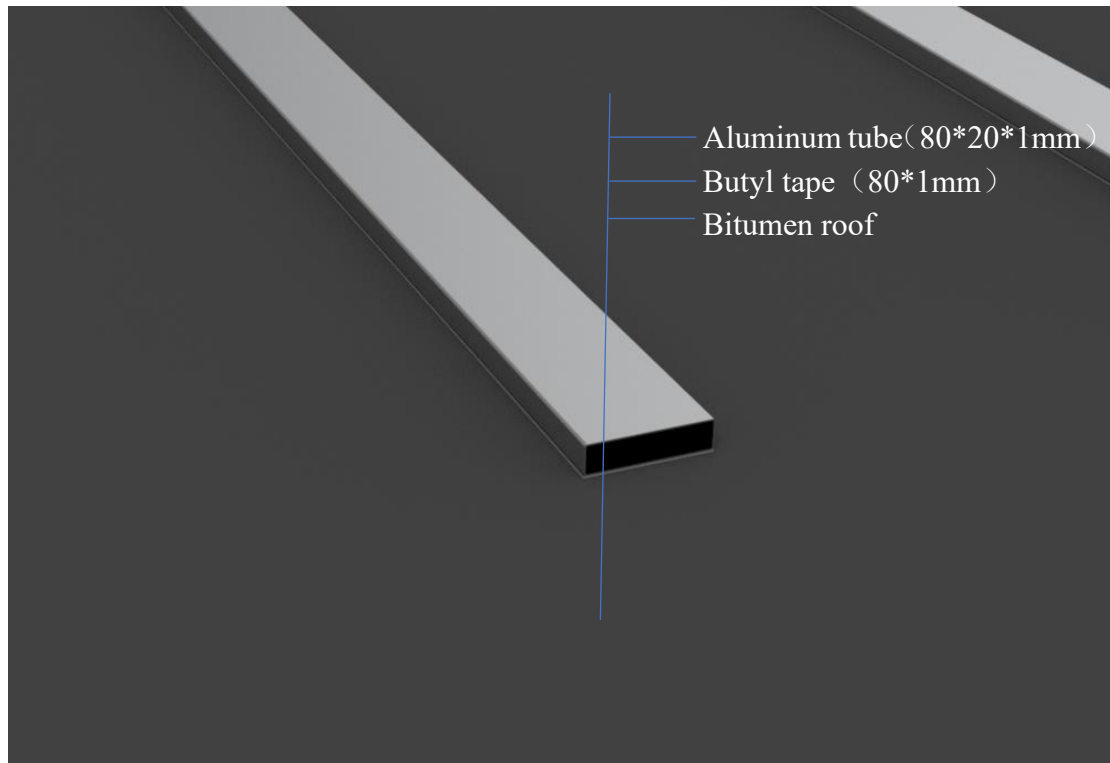

6.5.4 Laying modules

- Making Glue on the rail followed the Precautions and Tips for Gluing Modules;
- The two ends of a single module are continuously glued, and the middle adhesive area is glued sectionally. The glue length is 200mm. The sectional distance and glue length in middle can be adjusted according to the actual situation on site

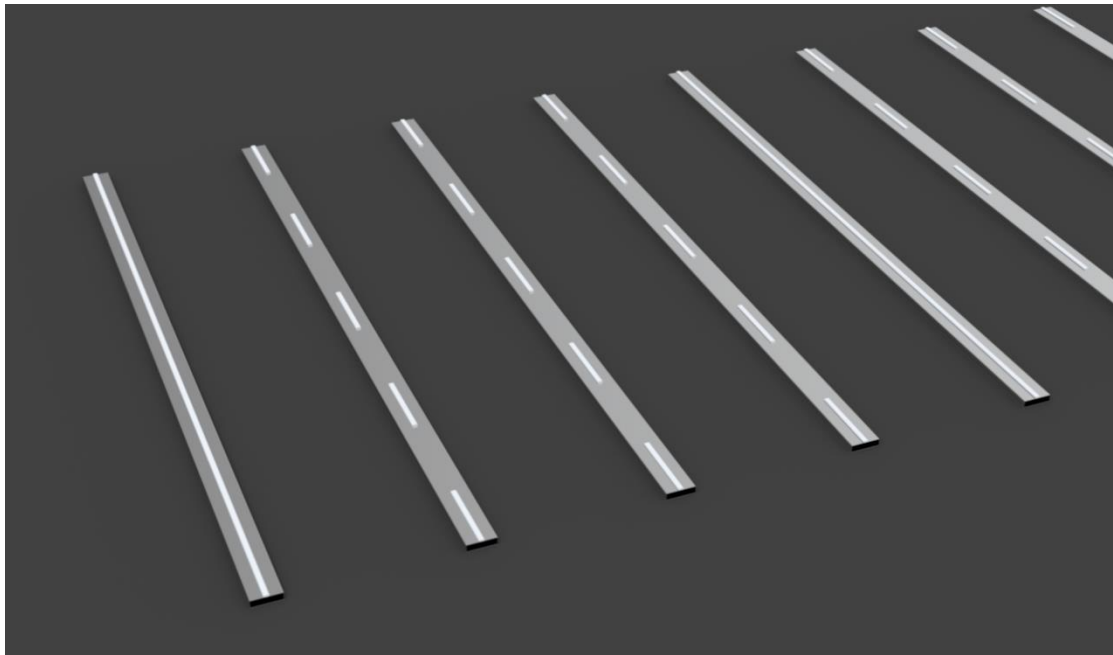

- Do not bend the module during installation. Two people should grasp the white edge of the module and place it onto the glue.
- Modules should be in a straight position during placement. Do not re-glue the modules.
- Once modules are placed, avoid hand-pressing the cell-area to facilitate adhesion. A plastic roller needs to be rolled over the surface of the module to ensure a good bond between the module and the CS.
- The minimum distance between the modules is 5mm, and the distance between each array is 500-800mm, which is used as a construction maintenance walkway. (This spacing is for reference only)
- If the module is selected as 12*12 series (the junction box is in the long side direction of the module), the junction box side should be placed at the edge position for wiring and maintenance.
- Install remaining modules according to the preceding steps

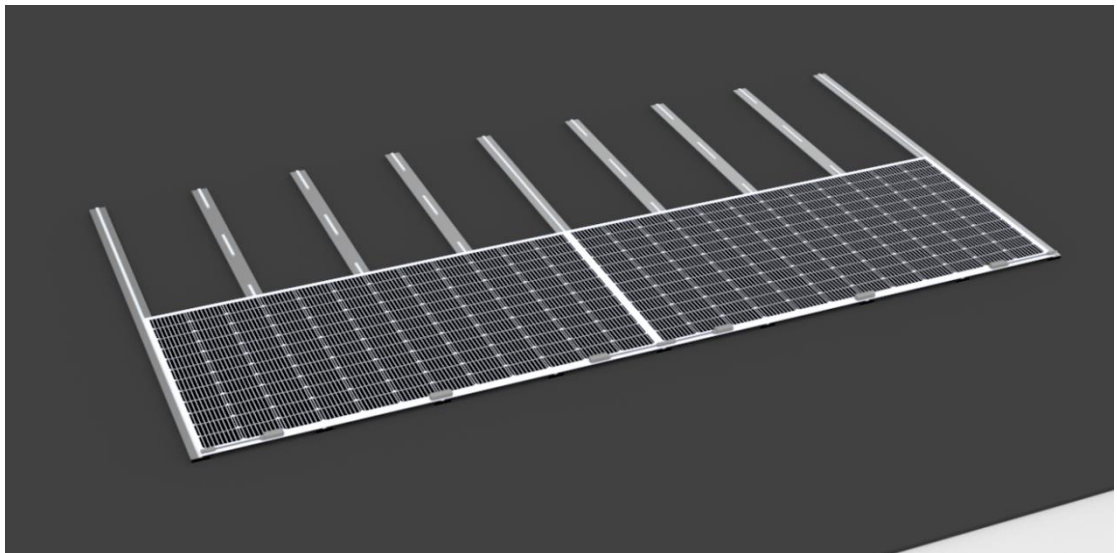
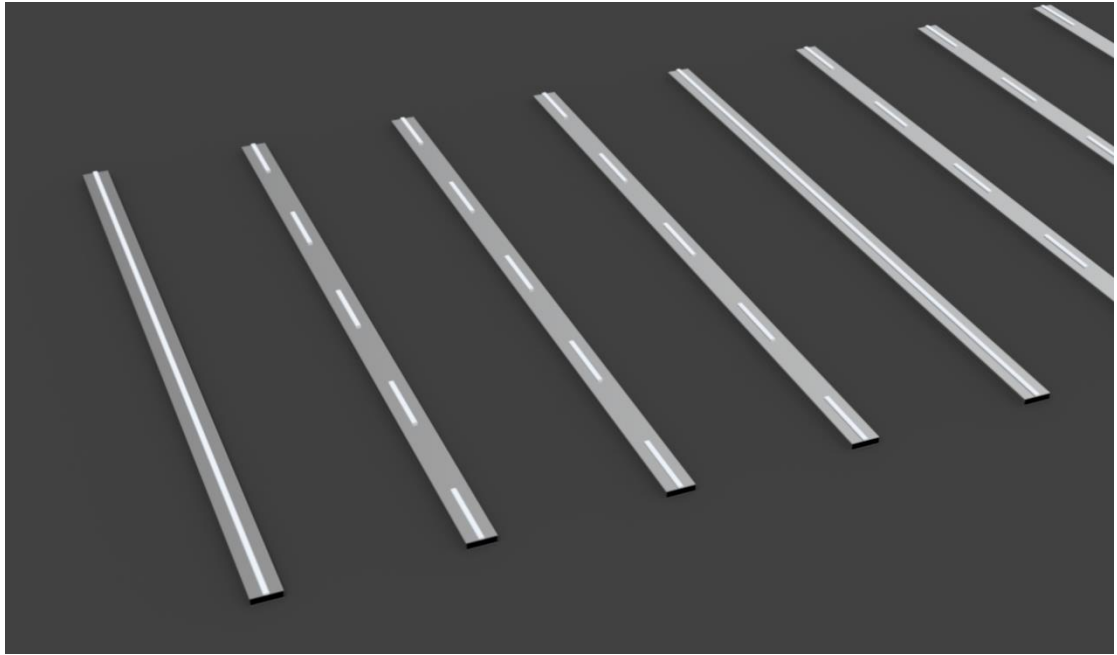

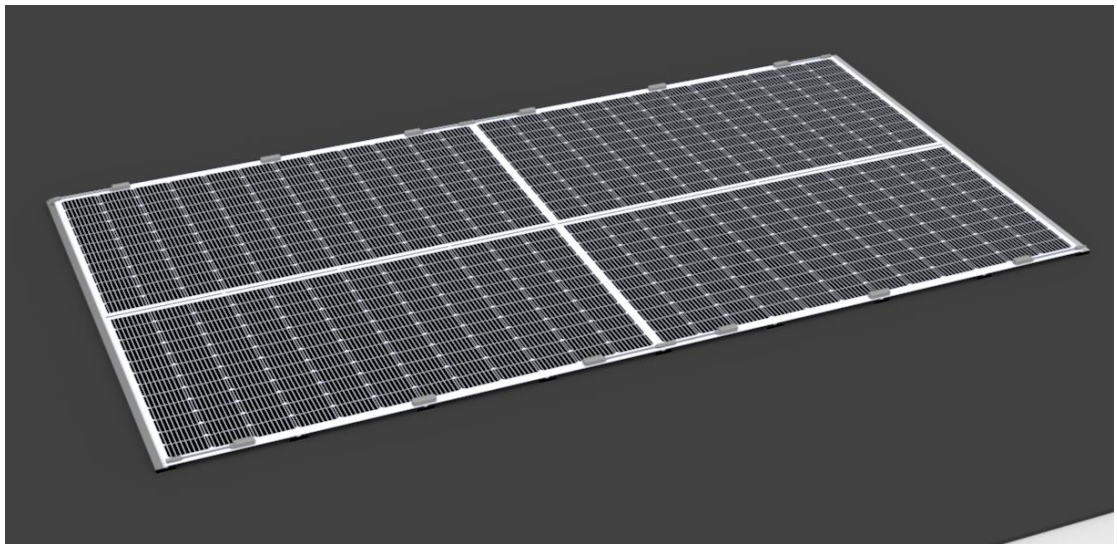
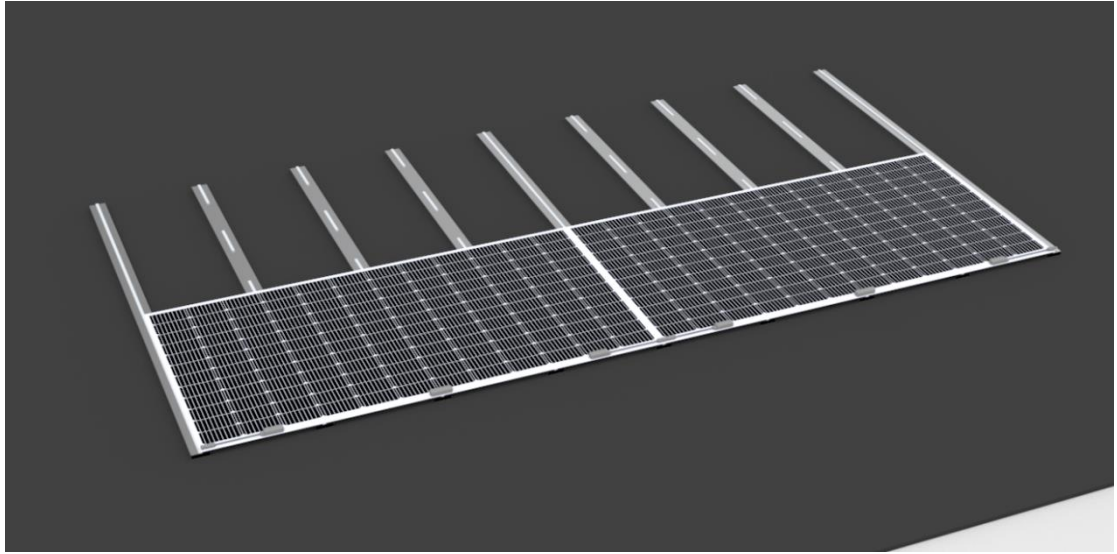

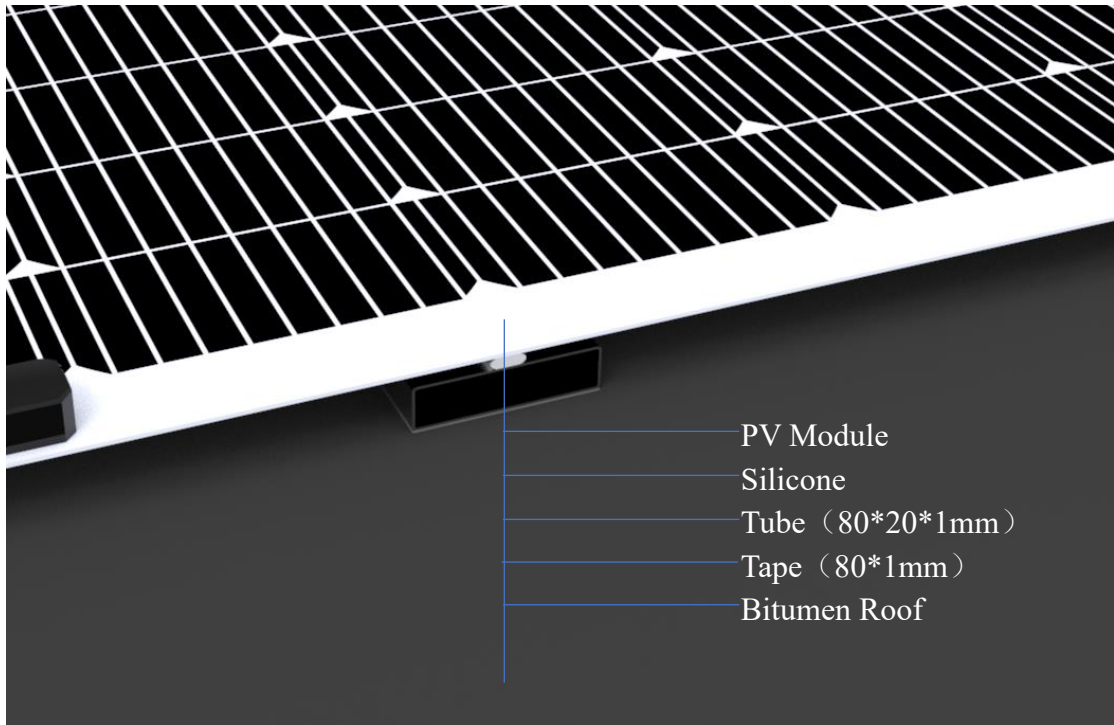

6.5.4 Joint of tubes

During the project installation process, the tubes need to be combined into a longer square tube, please strictly follow the following two methods to operate:

Method one: Put the joint between two modules

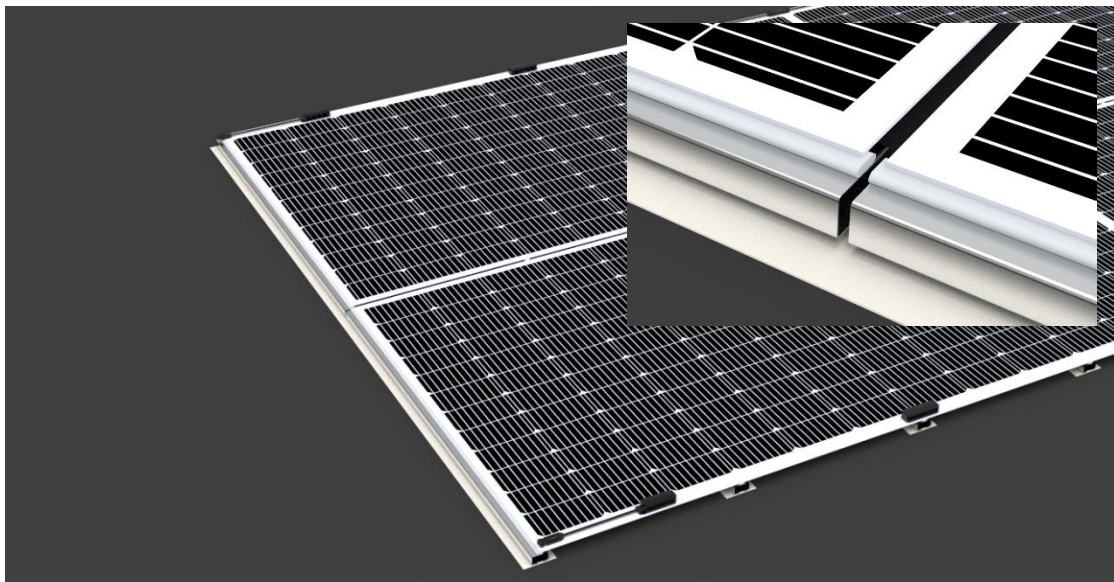

Method two: The joint be fixed with connectors and fasteners.

Connection style is for reference only, can be customized according to the actual situation of the project suitable for the connection

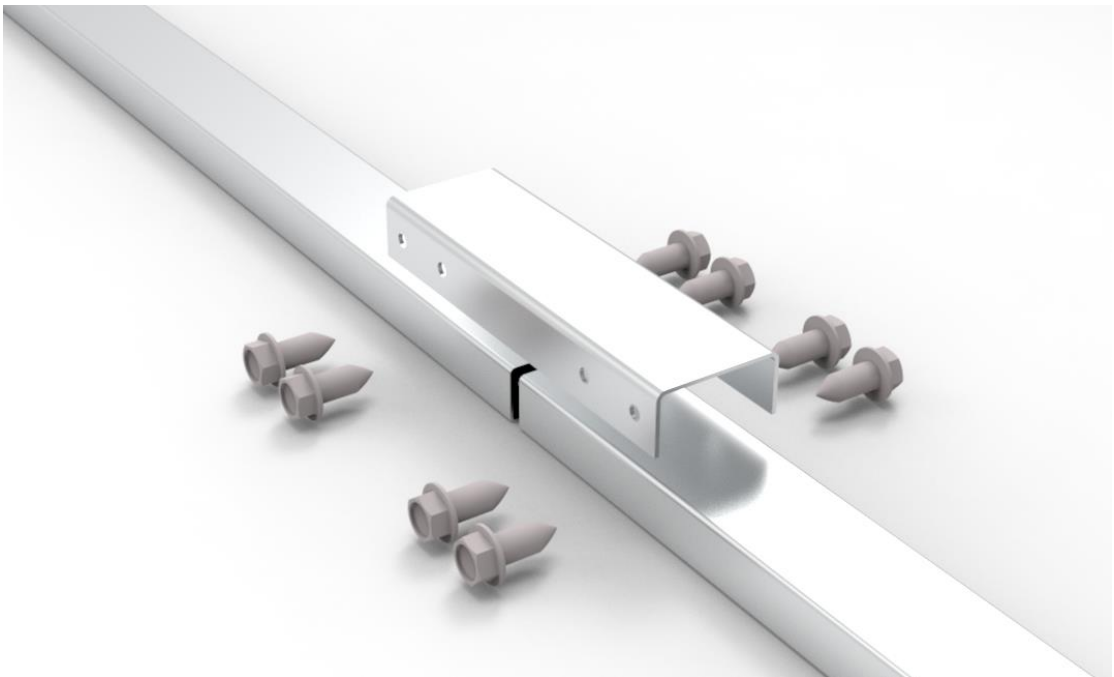
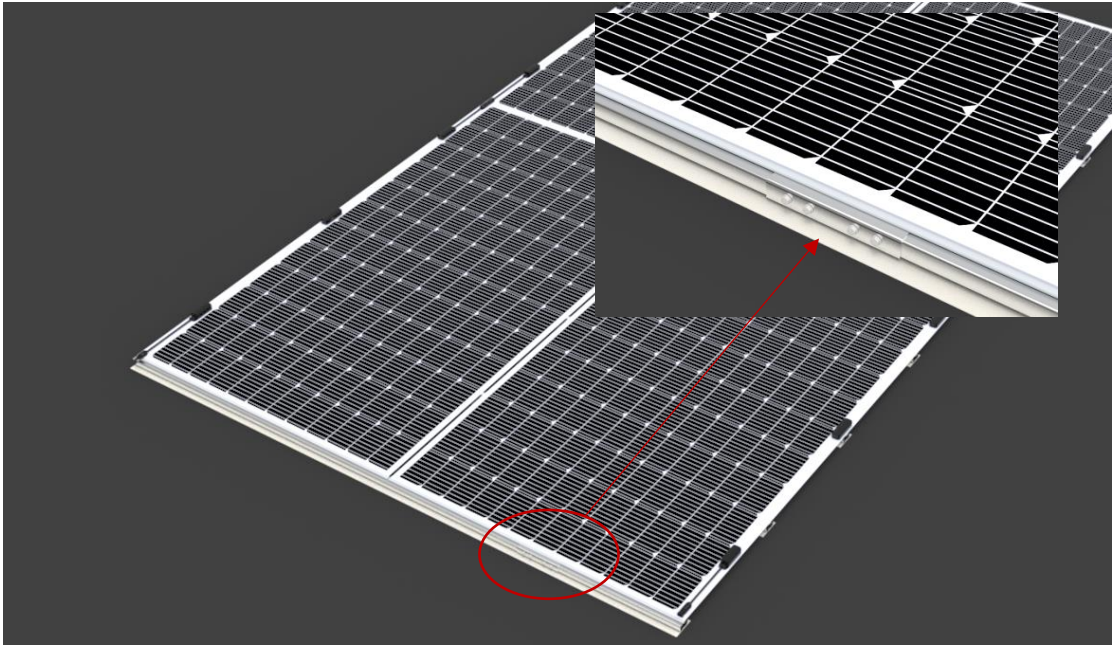

6.6 Wiring and testing

- 1) The use of PV modules with different configurations in a PV system is prohibited.
- 2) Excessive cables must be organized or fixed in the proper location.
- 3) For applications requiring high operating voltages, several PV modules may be connected in series to form a PV string, then the system voltage is equal to the sum of the voltages of each PV module

- 4) For applications requiring high operating currents, several strings of PV modules can be connected in parallel to form a PV string, then the system current is equal to the sum of the currents of each PV module string.
- 5) A maximum system voltage of 1000VDC is allowed.
- 6) The maximum number of PV modules in series depends on the system design, the type of inverter used and the environmental conditions;
- 7) Depending on the maximum series fuse rating of the PV module and local electrical installation codes, if the PV module does not have any fuses or blocking diodes, make sure to connect no more than two strings in parallel;
- 8) There is no limit to the number of PV modules that can be connected in parallel (fuses per string should be considered), the number of PV modules is determined by system design parameters such as current or power output;
- 9) Please refer to local regulations to determine the size, type and temperature of the system conductors;
- 10) PV modules are equipped with connectors for system electrical connections, please refer to local regulations and data sheets that allow the use of connectors;
- 11) To ensure a reliable electrical connection and to prevent possible moisture ingress, connectors must fit and lock together until a click is heard;

The DC power generated by the PV system can be converted to AC power and connected to the public grid, as the local power company's policy for connecting renewable energy systems to the grid varies from region to region. You can ask your PV system design engineer or integrator for help in obtaining building permits, inspections and approvals from your local power company's department.

7.0 Maintenance

To ensure optimal performance of modules and maximize system power generation, the following maintenance measures are recommended:

1 Module appearance inspection, focusing on the following points:

- a) Whether the module is damaged.
- b) Whether there is a sharp object touching the surface of the module.
- c) Whether the modules are obstructed by obstacles and objects, avoiding new trees, new poles etc. to shielding the modules.
- d) Check for corrosion near the busbar. This kind of corrosion is caused by the damage of the module surface during transportation, which causes moisture to penetrate into the interior of the module.
- e) Check the adhesive between the module and the roof for looseness or damage and adjust or repair it in time.

2 Clean the modules. The accumulation of dust or dirt on the surface of the modules will reduce the power output. It should be cleaned regularly to keep the surface clean. Generally, it should be cleaned at least once a month, appropriately increase the frequency in the harsh natural environment. Pay attention when cleaning PV modules:

- a) Rinse with water first, then dry the water with a soft cloth. Do not use corrosive solvents to clean or wipe the PV modules with hard objects.
- b) The PV module should be cleaned at an irradiance of less than 200 W/m^2 . It should be cleaned in the absence of sunlight or in the morning and evening.
- c) It is strictly forbidden to clean PV modules under meteorological conditions where the wind is greater than grade 4, heavy rain or heavy snow.

Note: Do not walk, stand or sit on the module when cleaning.

3 Connector and cable inspection. It is recommended to conduct a preventive inspection every six months:

- a) Check for signs of aging of PV modules, including possible rodent damage, weathering, and whether all connectors are tightly connected or corroded.

Annex A

Electrical performance parameter

Series	Products	STC					module size
		Pmp	Vmp	Imp	Voc	Isc	
	SMF430F-12X12UW	430	42.0	10.24	49.8	10.74	2054*1080*2
	SMF430F-6X24UW	430	42.0	10.24	49.8	10.74	2120*1046*2

Annex B

Installation for different roof materials

Roof type	Primer needed	Primer type	Adhesive type
TPO	No	\	Butyl tape
Bitumen	Yes	Contact Sunman	Butyl tape
Glass	No	\	Butyl tape

Annex C

Cleaning agent

Roof type	Cleaning agent recommended by Sunman
TPO, PVC, Bitumen, EPDM, etc. plastic roof	Plastic cleaner China: RA-1033 Overseas: Use the cleaning agent recommended by the roofing material supplier
glass roof, metal roof	90% isopropanol + 10% water

Use the cleaners listed above or those recommended by the roofing material supplier.



Annex D

Gluing operation specification

1. Gluing nozzle cutting

The standard nozzle cutout is 10.5mm x 6mm, which is made by cutting about 20mm from the original nozzle and flattening it to the required size, as shown in the figure below.

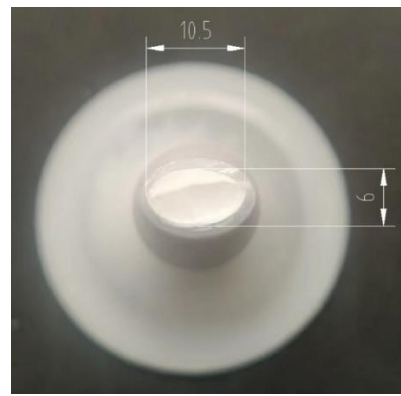

Nozzle cutting should be carried out in strict accordance with the following procedures.



Standard tool shears (complimentary with adhesive)

Operation steps



1. Use a straightedge or tape measure to measure the length of the head of the nozzle 20mm, confirm the cutting position, and then use the tool to cut in addition.



2. It is recommended to use a lighter to heat the tip of the rubber nozzle for about 2s to prevent it from springing back after being flattened.



3. Squeezing of the nozzle to the desired size using a flattening die of the tool shears.

2. Electric glue gun adjustment

Standard glue-out speed: Half turn of the speed knob, see the following figure:

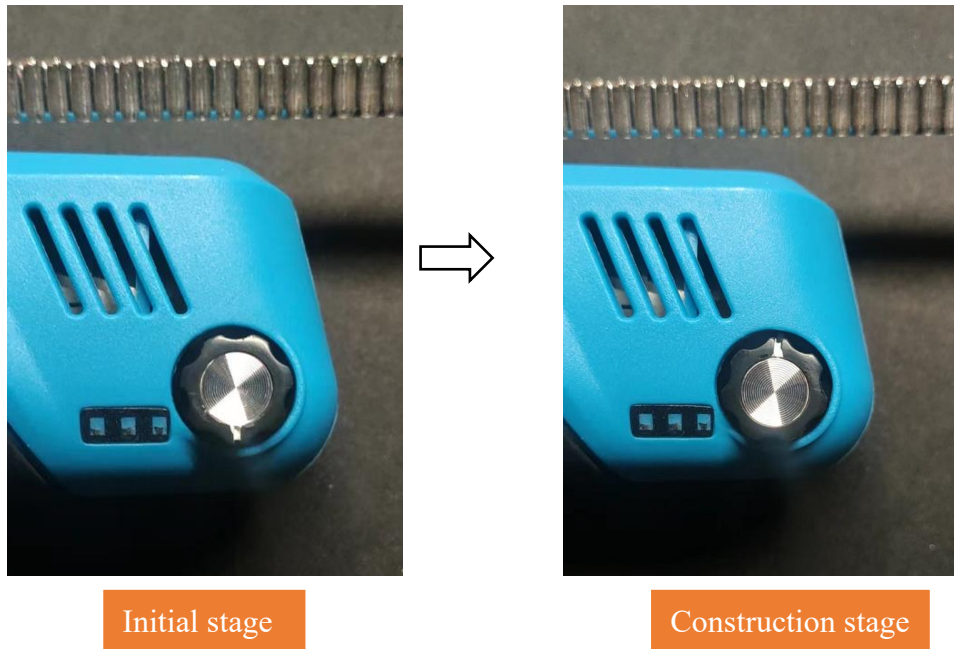

3. Gluing parameters

Gluing length: 10.8m/600ml on average

Gluing speed: about 10cm/s



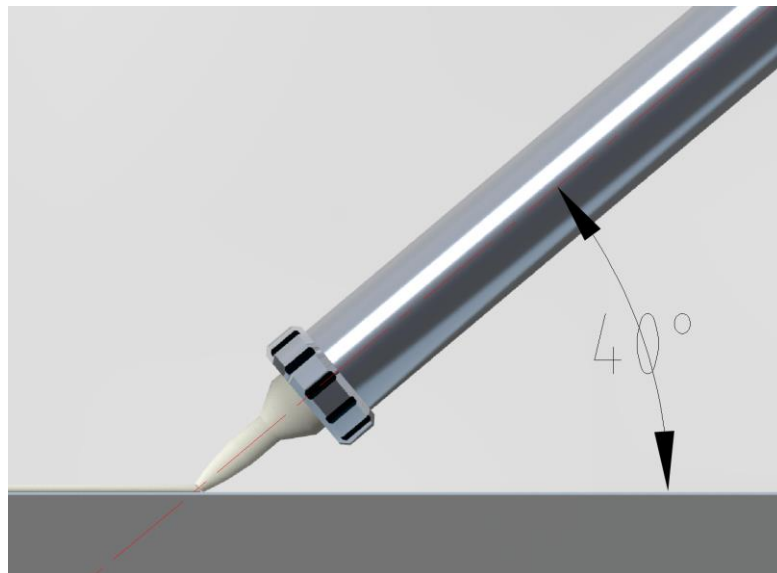





Gluing angle: the glue gun is at an angle of about 40° with the ground, as shown in the following figure:

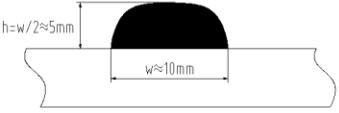







Adhesive size and standard dosage: at least 10*5mm; 5 strips/1 module (adhesive along the width of the PV module); 3 strips/1 module (adhesive along the length of the PV module)

4. Structural adhesive form

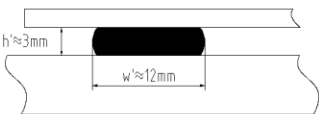
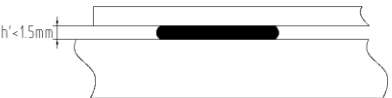
Please see below for proper bead application

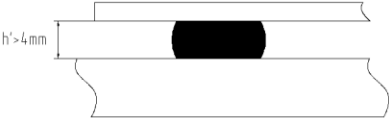
	
 Correct dimension	 Too flat
	
 Too high, too small	 Poor wetting

The correct form of structural adhesive after pasting modules

	
 Correct dimension	 Too flat
	
 Too high	 Inclined

Annex E

Unpacking

Standard unpacking steps for light weight PV modules.



1. Remove all wrapping film and packing tape outside the package



2. Remove packing box cover (keep well for another purpose)

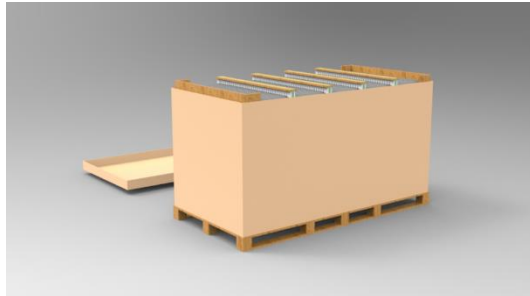

3. Place the cover next to the box with the opening up



4. Remove the outer packaging carton



4.1. Box cover retention (handling module auxiliary parts)



5. Remove the upper fence on the side of the wooden box, keep the lower fence



6. Use scissors or a hobby knife to cut off the packing tape used to secure the module (do not cut the module)

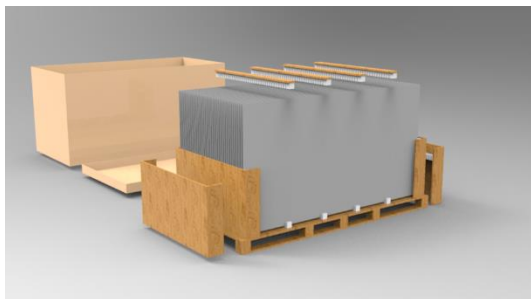
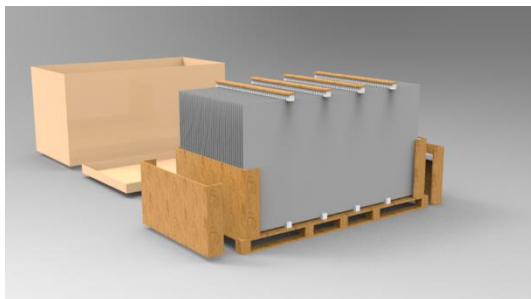

7. Remove the fixing clip above the module

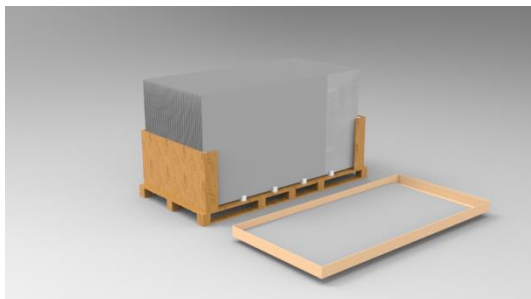
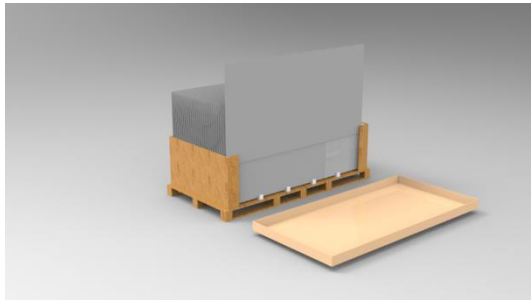
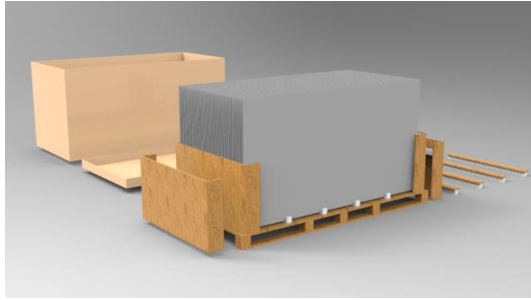

8、 To pick up the module, please raise the module to the height of the lower C-shaped enclosure and move out the module

When picking up the module, please grab the non-cell white area of the module.

When picking up the module, grab the long side direction of the module, the short side direction of the module can only be short grabbed again when out of the box operation

9、 Place the box cover open side up and transport the module flat inside the cover to the project designated installation site Place a maximum of two modules in the cover, separated from each other with foam inside the box

Use a minimum of four foam strands, placed evenly between the stacked modules.

Module stacking and handling operations are as follows:

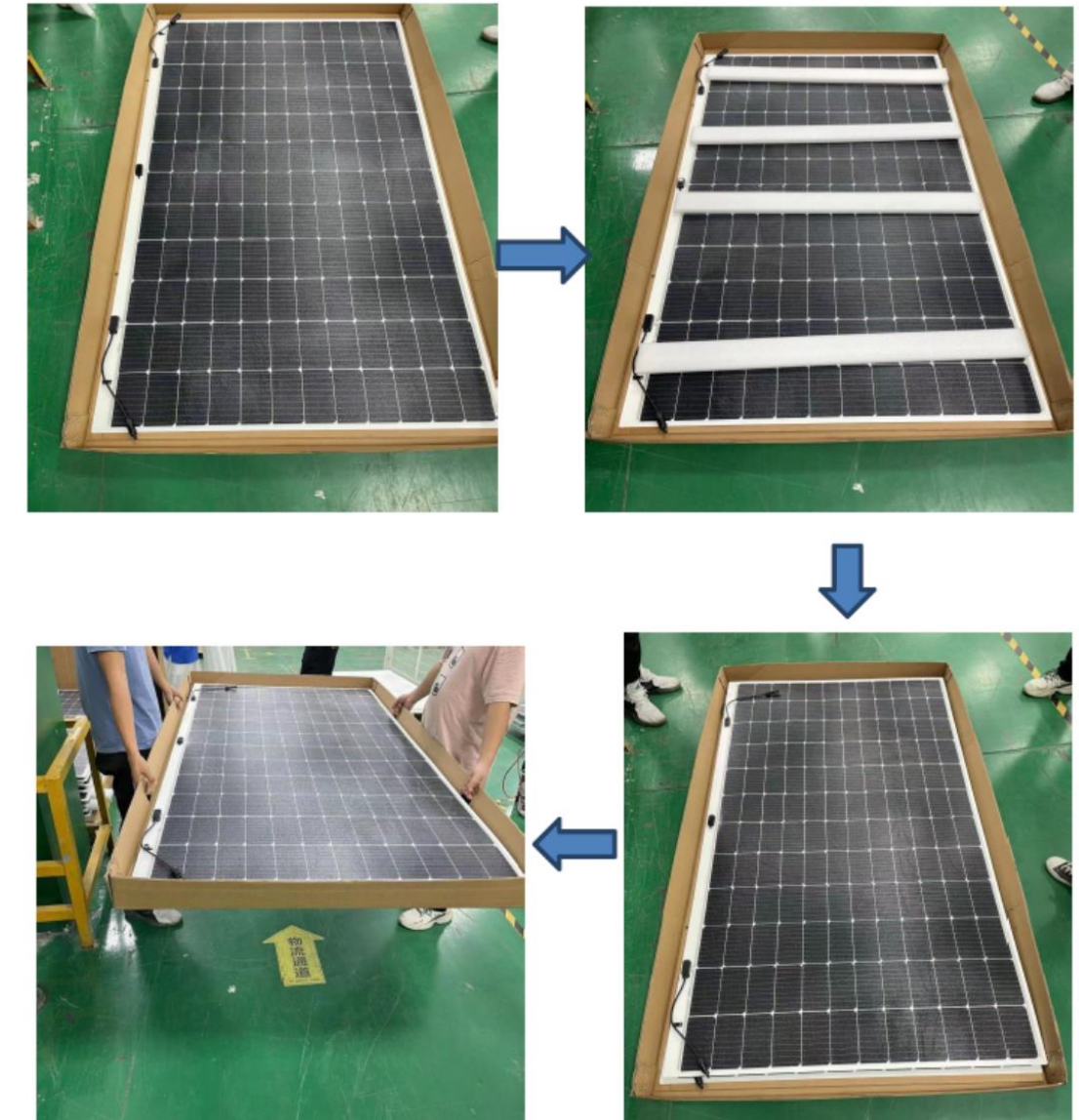

Unpacking precautions

Avoid operating in rainy weather when opening cartons outdoors.

Secure the modules when operating outdoors in windy conditions.

Stack components in a ventilated, rain-proof, and dry area before unpacking them.

Do not to damage the front or back of the module when using scissors or hobby knife to cut the outer packing tape.

Confirm the number of modules in the box promptly after unpacking.

The unpacking area needs to ensure that the box is placed horizontally and stably to avoid tipping of the modules.



During unpacking and handling, please wear protective gloves properly to avoid scratches.

Prohibit pulling on junction boxes or cables under any circumstances.

When handle the modules, avoid touching the cell area with hands.

eArc SMF
Installation Manual
for Flat Roofs with CS
Silicone

Contents

1.0 Summary.....	1
1.1 Disclaimer.....	1
1.2 Responsibility.....	1
1.3 Copyright and Trademark Information.....	1
1.4 Warranty Warnings.....	2
1.5 For Further Information.....	2
2.0 Safety precautions.....	2
3.0 Mechanical / electrical properties.....	4
4.0 Storage and unpacking.....	5
5.0 Installation.....	6
5.1 Module wiring.....	8
5.2 Grounding.....	8
6.0 Installation instructions.....	9
6.1 Module and tools.....	9
6.1.1 Module.....	9
6.1.2 Construction materials.....	9
6.2 Unpacking, Handling and Checking Precautions.....	10
6.3 Construction Precautions.....	11
6.4 Precautions and Tips for Gluing Modules.....	11
6.5 Construction plan.....	12
6.5.1 Cleaning the roof surface.....	12
6.5.2 Positioning and releasing the line.....	13
6.5.3 Brush primer (ignore this step if no primer required for the roof material)	14
6.5.4 Paste CS.....	15
6.5.5 Laying modules.....	16
6.6 Wiring and testing.....	19

7.0 Maintenance	21
Annex A	22
Electrical performance parameter	22
Annex B	23
Installation for different roof materials	23
Annex C	24
Cleaning agent	24
Annex D	25
Gluing operation specification	25
1. Gluing nozzle cutting	25
2. Electric glue gun adjustment	26
3. Gluing parameters	27
4. Structural adhesive form	28
Annex E	29
Unpacking	29

1.0 Summary

Thank you for purchasing Sunman eArc PV modules. This guide contains information regarding the installation and safe handling of Sunman (Zhenjiang) Company Limited eArc SMF PV system on Roofs. Sunman (Zhenjiang) Company Limited referred to as “SUNMAN”. Users and installers must read and strictly follow the installation manual. Failure to follow these safety guidelines can result in personal injury or property damage. The installation and operation of solar modules require specialized skills, and only professionals can do the job. Please read the safety and installation instructions before using and operating the modules. The installer must inform the end customer (or consumer) of the above matters accordingly.

1.1 Disclaimer

Sunman reserves the right to change this installation manual without prior notice. The changes and the latest installation manuals after the changes will be published in the resource center of the official Sunman website. Customers should always pay attention to the above changes. Sunman will not provide further notice.

Failure in operating according to instructions in this manual during installation (Including the changes announced on the official website of Sunman at the time of installation) will cause the warranty to be invalid.

Sunman does not guarantee any expressed or implied information contained in this manual.

1.2 Responsibility

Whether or not the installation of the modules is carried out in accordance with the instructions in the installation manual (Including the changes announced on the official website of Sunman at the time of installation), Sunman shall not be held legally responsible for any damages incurred during the installation process, including but not limited to personal and property damage resulting from the operation of the modules and the installation of the system.

1.3 Copyright and Trademark Information

Copyright © 2023 by Sunman (Zhenjiang) Company Limited. All rights reserved. eArc and the SUNMAN logo are trademarks of Sunman (Zhenjiang) Company Limited.

1.4 Warranty Warnings

WARRANTY VOID IF NON-SUNMAN-CERTIFIED HARDWARE IS ATTACHED TO eArc™ PV System.

1.5 For Further Information

For additional technical support documentation, please visit the Support page of the SUNMAN website at ‘www.sunman-energy.com’.

2.0 Safety precautions



WARNING: Please read and understand all safety instructions before installing, wiring, operating, or maintaining modules. DC power is generated when the module is exposed to sunlight or other light sources. Direct contact with live parts of the module, such as terminals, whether connected or not, may result in personal injury or death.

Safety rules

- All installation work must be in full compliance with local regulations and corresponding national or international electrical standards.
- Use insulated tools to reduce the risk of electric shock.
- Use appropriate protective measures (slip gloves, overalls, etc.) to avoid direct contact with workers at 30V DC or higher, while avoiding direct contact with sharp edges during installation to protect the operator's hands.
- Do not wear metal ornaments when installing, to avoid puncturing the modules and causing electric shock.
- If modules are installed or operated on rainy days, strong winds or dew mornings, appropriate protective measures should be taken to avoid injury to modules and workers.
- Children or unauthorized personnel are not allowed to access the installation area or module storage area.
- If the circuit breaker and overcurrent protection circuit breaker cannot be opened, or if the inverter cannot be turned off during the module installation or wiring, cover the array modules with opaque material to stop the power output.

- Do not use or install damaged modules.
- If the module surface is damaged or worn, direct contact with the surface of the module may result in electric shock.
- Do not attempt to repair any part of the module, there are no user-accessible components within the module.
- The cover of the junction box should remain closed at all times.
- Do not split the modules or move any part of the module.
- Do not artificially condense light on modules.
- Do not connect or disconnect modules when there is current in the module or external current.

3.0 Mechanical / electrical properties

The rated electrical performance data for the modules is measured under standard test conditions (STC) of irradiance of 1000 W/m², AM 1.5, and cell temperature of 25 °C. The specific electrical and mechanical performance parameters of Sunman eArc modules are included in Annex A of this installation manual. The main electrical performance parameters under STC conditions are also marked on the nameplate of each module. The maximum system voltage for all modules is 1000V.

In some cases, the current or voltage generated by the module may be greater than the optimal operating current or voltage of its standard test condition (STC). Therefore, when determining the component rating and load value, the module open circuit voltage and short circuit current at STC should be multiplied by 1.25. Please check with your local rules and regulations.

4.0 Storage and unpacking

Precautions and general safety rules

- Store modules in a dry and ventilated environment.
- The modules must be transported in the package provided by Sunman and stored in the original package before installation. Please protect the packaging from damage. Open the package according to the recommended unpacking steps. Care must be taken during unpacking, shipping, and storage.
- Do not apply excessive loads on the modules or twist the modules.
- Do not carry the modules through the wires or junction boxes of the modules.
- Do not stand, climb, walk or jump on modules.
- Do not allow sharp objects to touch the modules. Scratches can directly affect the safety of the modules.
- Do not place the modules in an environment where there is no reliable support or is not fixed.
- Do not change the wiring method of the bypass diode.
- Keep all electrical connections clean and dry.

Product identification

- Barcode: each individual eArc has a unique serial number. The serial number has 21 digits. The 1st to 4th digits are the module type for internal use, and 5th to 8th digits are the year code, and the 9th and 10th digits are the month code, and the 11th and the 12th digits are the week code, and the 13th and 14th digits are the month code, and the 15th to 17th digits are order number, and the 18th to 21th digits are the sequence codes. For example, xxxx20210415xxxxxxxx means the module was made in the 15th week of 2021. Each module has only one bar code. It is permanently attached to the interior of eArc and is visible from the top front of eArc. This bar code is inserted prior to lamination.



- There is a nameplate, which shows the model number, main electrical properties, safety specifications and certification indicator, on the back of each module.

5.0 Installation

Precautions and general safety rules

- Before installing the modules, please contact the relevant department to obtain information about the installation site and the construction permit, and also comply with the installation and inspection requirements.
- Check the applicable building codes to ensure that the building to be installed and its structure (roof, facade, load-bearing, etc.) has sufficient load-bearing capacity.
- During installation, make sure that the modules are installed on a fire-resistant roof. According to UL790 standards, Sunman eArc modules are rated as fire rating C.
- The eArc modules are compliant with application level A (equivalent to safety level II, IEC 61730-1). This type of modules can be used in systems where the public is likely to come into contact with voltages greater than 50V or power greater than 240W.

Environmental conditions

The modules are suitable for general climatic conditions, ie with reference to IEC 60721-2-1- Classification of environmental conditions Part 2-1: Environmental conditions occurring in nature - temperature and humidity.

- If the modules are used in a special installation environment, please consult the technical support department of Sunman in advance.
- The installation surface should be flat without bumps or pits.
- The modules must not be installed near flames or flammable objects.
- Do not expose modules to artificial condensing light sources
- The modules should not be immersed in water (pure water or salt water), installed in long-term water environment (pure water or salt water) (eg fountains, sprays, etc.) or area prone to water accumulation (eg roof drain, low-lying areas, etc.).
- Please consult SMF installation manual for Flat roofs if roof area has poor drainage or extended water pooling.
- If the module is placed in a salt mist (ie marine environment) or in an environment containing sulfur (ie, sulfur sources, volcanoes, etc.), there is a risk of corrosion.

- **Failure to follow the above precautions, Sunman Warranty will be voided.**

Installation requirements

- Ensure the modules meet the overall technical requirements of the system.
- Ensure that components of other systems do not cause damaging mechanical or electrical performance effects on the modules.
- Connect modules in series to increase voltage or in parallel to increase current. When connected in series, the positive pole of the module is connected to the next negative pole. When connected in parallel, the positive pole of the module is connected to the positive pole of the next module.
- The number of bypass diodes provided varies depending on the module model.
- Connect the appropriate number of modules according to the voltage specifications of the inverter used in the system. Even at the lowest local temperature conditions, the connected modules must produce no more than the voltage allowed by the system. If overcurrent protection devices (fuse) are not used in series within each string of modules, up to two strings of modules can be connected in parallel. If a suitable overcurrent protection device is connected in series with each string of modules, three strings or more modules can be connected in parallel.
- In order to avoid (or reduce) the mismatch effect of the array, it is recommended to connect modules of similar electrical performance on the same string.
- In order to reduce the risk of indirect lightning strikes, loops should be avoided when designing the system.
- The modules should be securely fastened to withstand all possible loads, including wind and snow loads.

Optimal orientation and inclination

- In order to achieve maximum annual power generation, the optimal orientation and inclination of the PV module should be determined first. The maximum electrical energy is typically generated when sunlight is directed onto the PV module.

Avoid shadows

- Even small shadows (such as dust) can cause a drop in power generation. If all surfaces of the module are uncovered throughout the year, the module is considered "no shadow". Ensure that the sun shines on the modules even on

the shortest day of radiation all through the year.

- EVA aging caused by frequent occlusion of modules and long-term heating of the diode can affect the lifetime of the module.

5.1 Module wiring

Correct electrical wiring

- Check that the wiring is correct before starting the system. If the measured open circuit voltage (Voc) and short circuit current (Isc) do not match the specifications provided, there may be a wiring fault.

Correct connection of the MC4 connector

- Make sure the MC4 connector is secure and properly connected. The MC4 connector must not be subjected to external pressure. The MC4 connector can only be used for circuit connection functions and should not be used to turn the circuit on and off.
- The MC4 connector should be kept dry and clean to prevent rain and moisture. Avoid direct sunlight and water soaking of the MC4 connector.

Use appropriate materials

- Depending on local fire, construction and electrical standard, use dedicated solar cables and suitable MC4 connectors to ensure the electrical and mechanical performance of the cable.
- The solar cable licensed for use is a single-wire cable, 2.5-10mm² (8-14 AWG), 90°C grade, with appropriate insulation to withstand the maximum possible system open circuit voltage. The appropriate wire size needs to be chosen to reduce the voltage drop. The wire should be made of copper.

Cable protection

- Secure the cable to the mounting system with a cable tie that is UV resistant. Appropriate measures should be taken to protect the exposed cable from damage (eg. in a plastic sleeve with UV aging resistance). Avoid direct exposure of the cable to direct sunlight.

5.2 Grounding

- With adhesive on the back of SMF modules and CS, there is no metal conductor for the module or the bracket, so no grounding of module is required.

6.0 Installation instructions

6.1 Module and tools

6.1.1 Module

Applicable module model: SMF430F-12X12UW, SMF430F-6X24UW

The electrical performance parameters are detailed in Annex A.

6.1.2 Construction materials

- CS, silicone sealant (glue), butyl tap, gluing gun, plastic roller, cleaning tool, tape measure, thread release tool, etc.

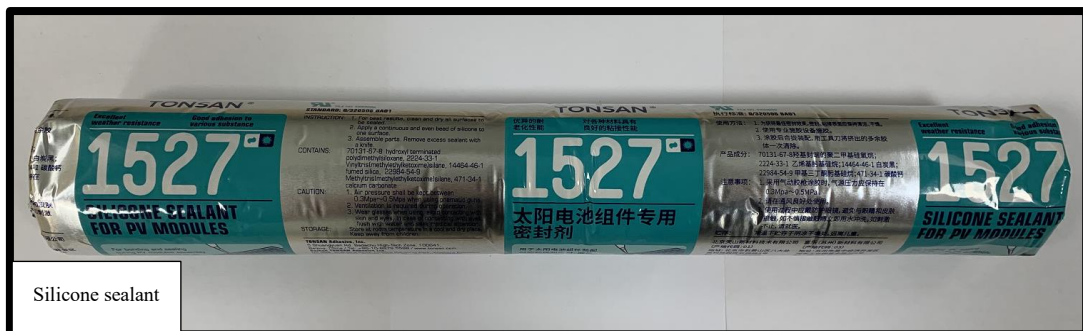
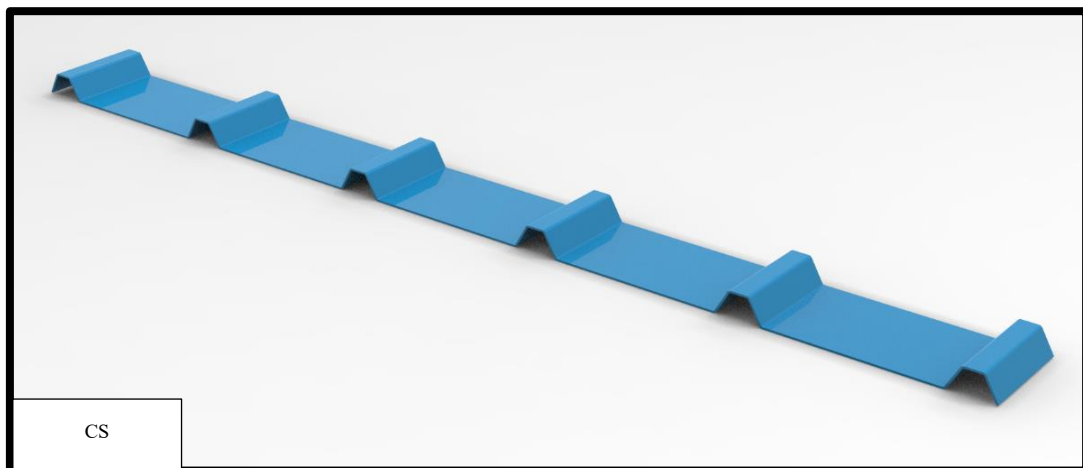



6.2 Unpacking, Handling and Checking Precautions

- Do not open modules outer Package before installation.
- Check the outer package for damage before unpacking.

- Slip-Proof Gloves are recommended for unpacking and handling.
- Do not grab the modules by the junction box or cables during unpacking or handling.
- Modules should be handled and lifted by at least two people. Do not touch the solar cell area during handling to avoid cell-cracks.
- Be careful while carrying the modules. Avoid hitting the modules on the ground or other sharp, hard objects. Scratches will affect the module's safe operation.
- Check the surfaces of the modules, make sure there's no damage to the frontsheet and the backsheet.
- Check the junction box, connectors, and cables for any damage. Double check if the junction box cover is fixed securely.
- Do not paint or apply glue or label on the surface of the modules.

6.3 Construction Precautions

- Normal construction can be carried out in the temperature range of -10 to 45 Celsius degrees (5 to 40 Celsius degrees is the best), and the humidity is below 80 %rh.
- The surface of the roof must be cleaned or wiped dry, free of floating soil, oil, etc. In order to achieve the required adhesion, the roof shall be cleaned using the cleaning agent specified in Annex C or Sunman- approved cleaning agent.
- After initial installation, the panel and adhesion shall not be disturbed for 24 hours.
- The roof angle is within 45 degrees.
- The paste surface needs to be flat and free of pits or bumps.
- The height of the structural adhesive after pasting should not be less than 3mm. Do not use feet or other non-designated tools to compact the structural adhesive.

6.4 Precautions and Tips for Gluing Modules

- Please make sure the surface is cleaned and there are no water pits before gluing;
- Glue along the middle line of the trapezoid or wave crest. Width of silicone glue strips should exceed 10 mm and height of the strips should exceed 5 mm

- Applying the silicone glue should be a continuous and even movement. Please use a roller to spread out the glue strips evenly. Do not smooth out the lines of glue to spread them out;
- Make sure to complete the gluing and mounting over a duration that does not exceed 5 minutes;
- Silicone sealant will cure to a depth of 2-3mm in 48 hours. Do NOT apply any force on the module before curing is complete;

6.5 Construction plan

Note: The installation steps are for TPO roofs, for reference only, different roof types can refer to this step for construction.

Installation steps

6.5.1 Cleaning the roof surface

Remove debris from the roof base and use a designated or approved cleaning agent (Annex C) to clean the roof. If the roof is very dirty, use a low-pressure water spray or power washer before using the cleaner. Optionally, use a mixture of 1/4 cup of trisodium phosphate, 1/2 cup of liquid cleaner and 5 gallons of water for cleaning.

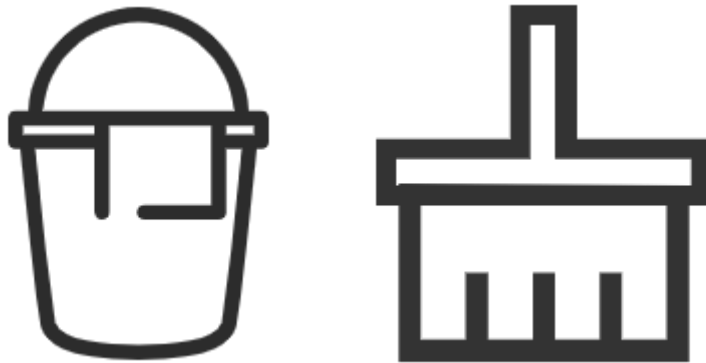

6.5.2 Positioning and securing the line



- Positioning and securing lines to determine the spacing of CS supports in accordance with the design drawings (For design drawings, please contact Sunman).





6.5.3 Brush primer (ignore this step if no primer required for the roof material)

- Determine the gluing area of the modules after the roof cleaning (refer to the design drawing for specific dimensions);

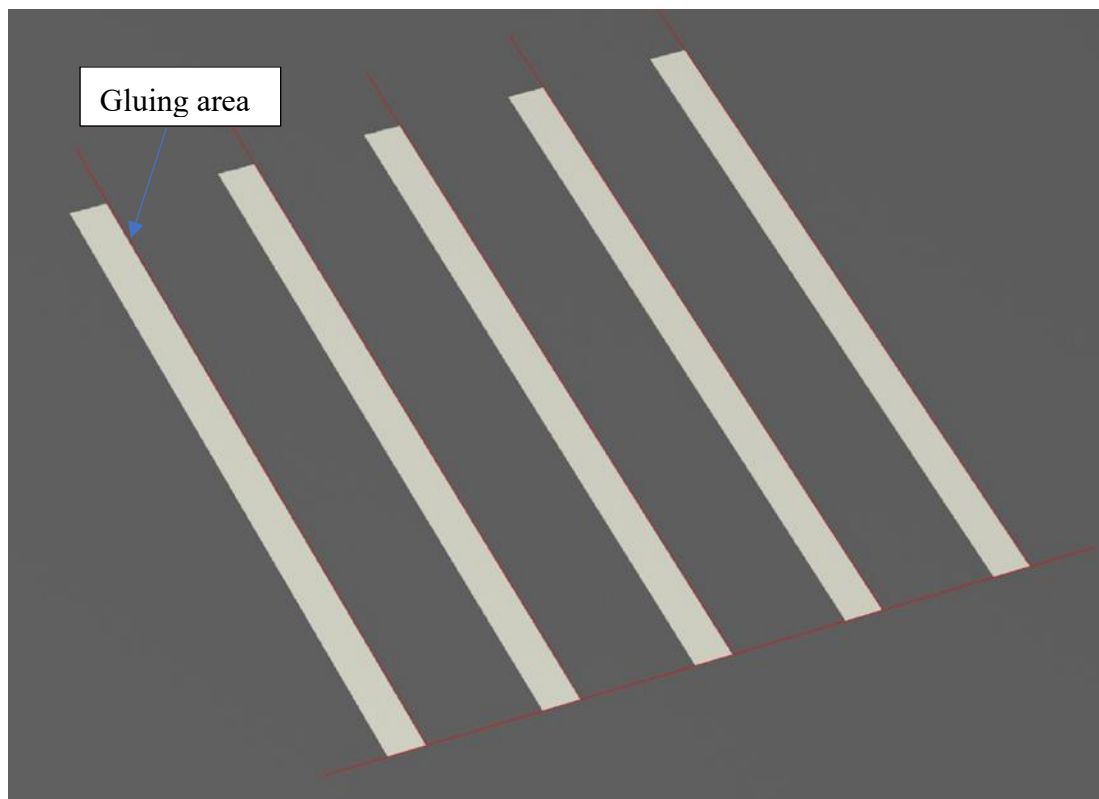

- Clean the gluing area again, wipe the area with the cleaning agent in Annex C;

- For the gluing area, brush primer before gluing to increase adhesion (see Annex B for different types of roof primer).

6.5.4 Paste CS

- Apply glue on the back of the CS support member in accordance with the requirements of the gluing specification.
- Apply glue two strips horizontally at the back of the CS support (as shown in the below figure).

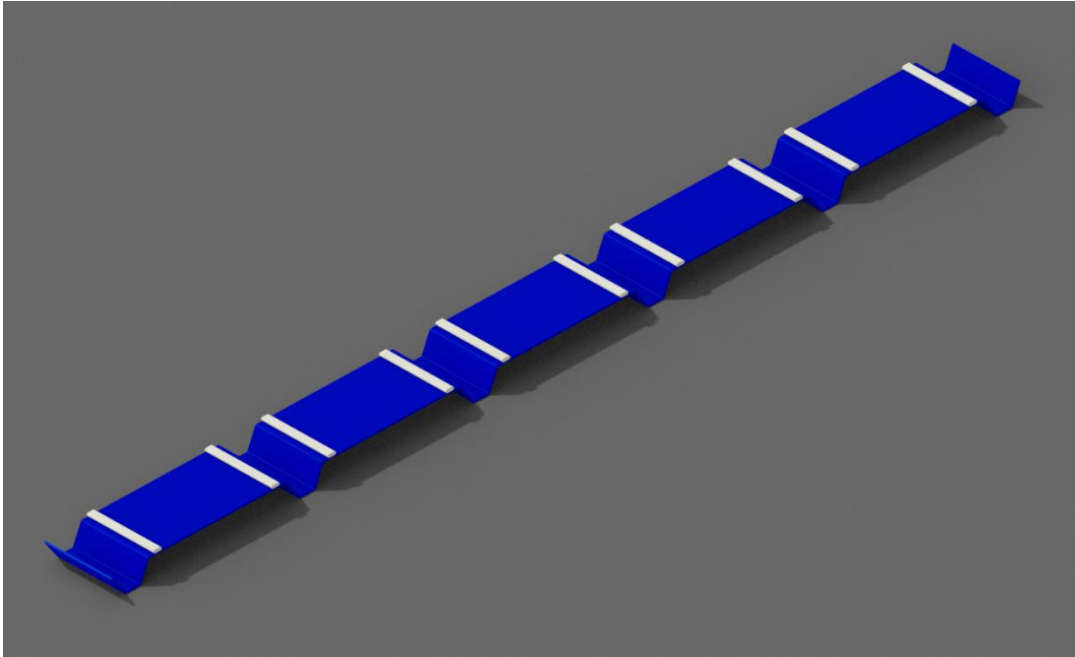

- Paste the CS supports along the gluing area and softly press them, keeping the thickness of the glue not less than 3mm.

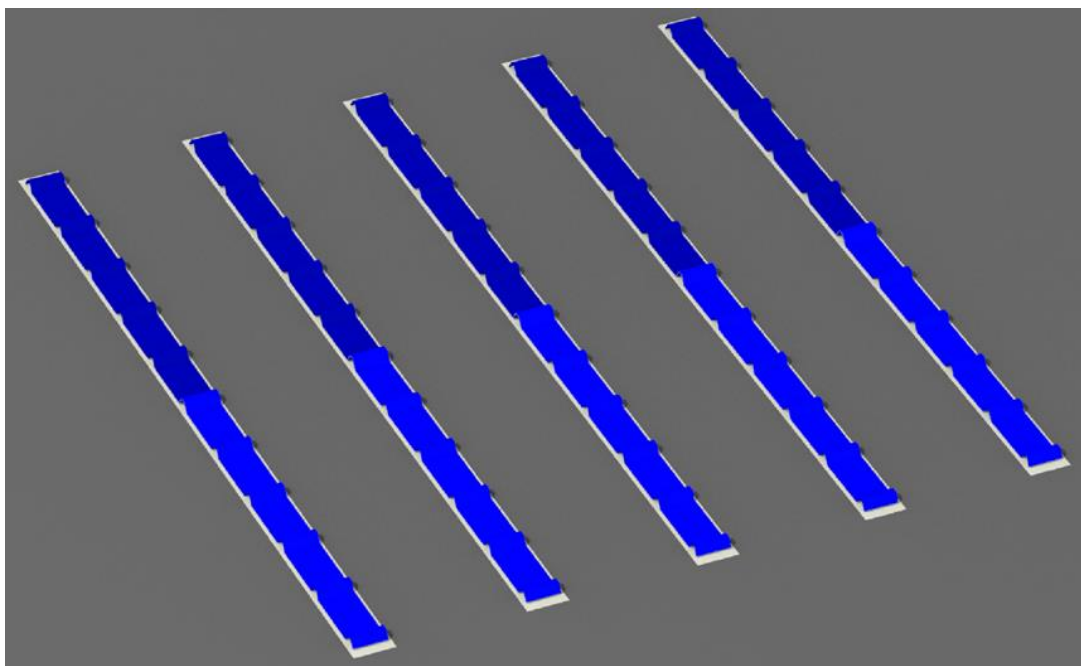

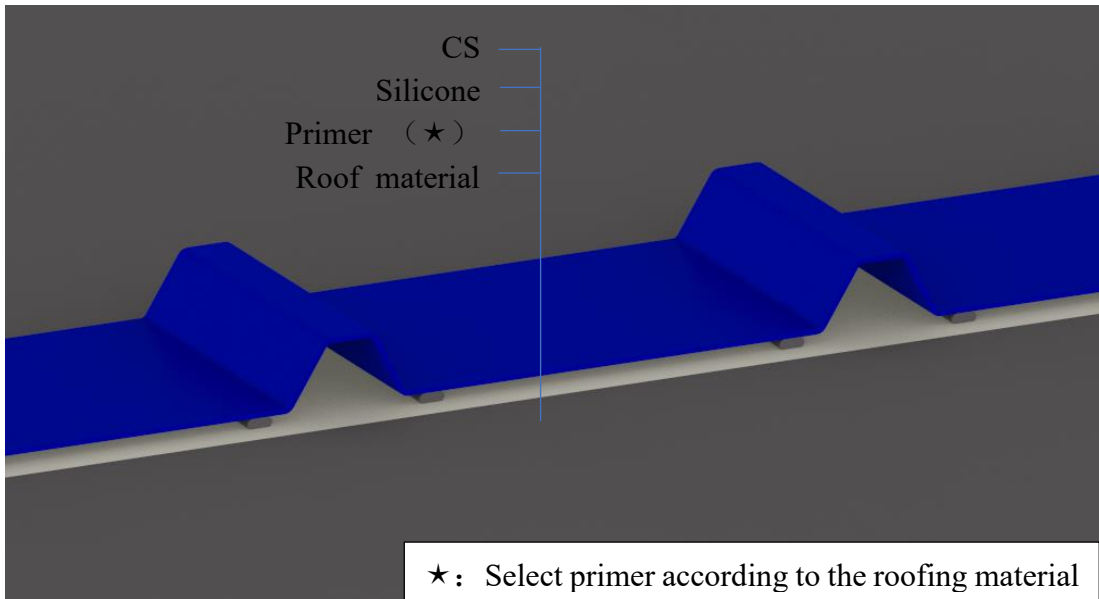

- Overlap the crests of 2 adjacent CS supports, and use structural adhesive to paste the lap joint together (as shown in the figure)

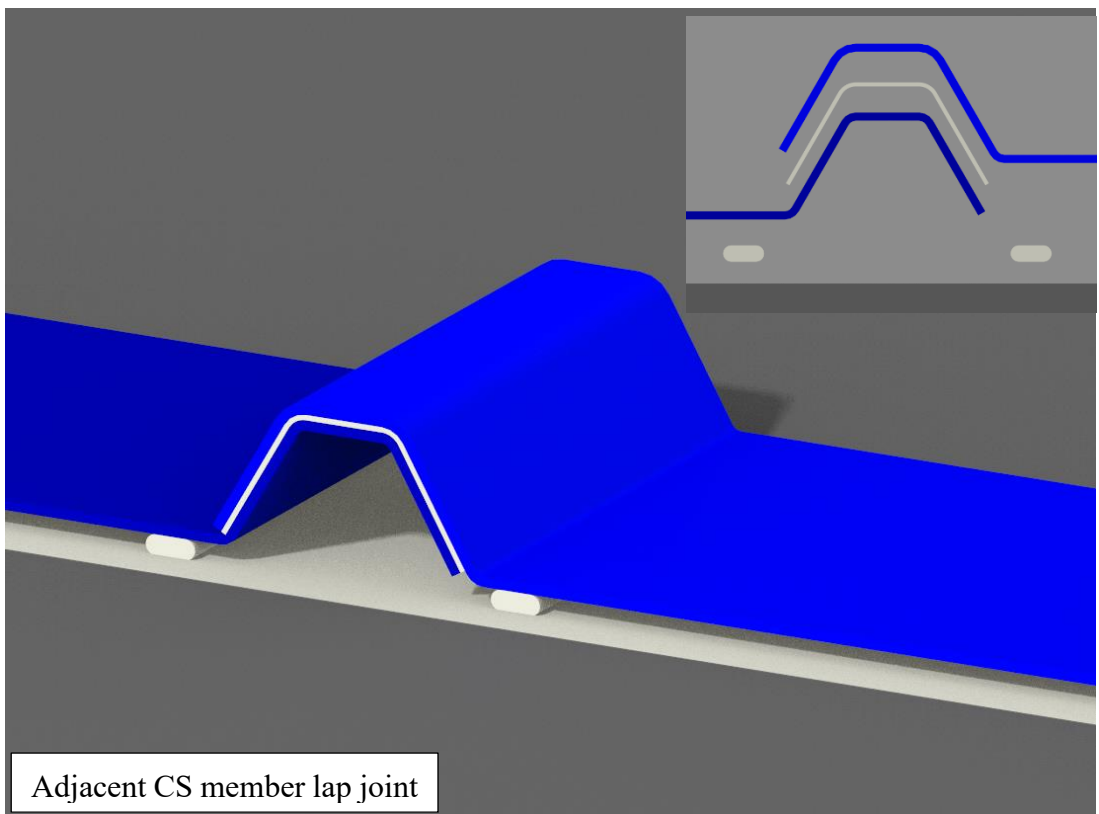

6.5.5 Laying modules

- Glue at the crest of the CS in accordance with the requirements of the gluing specification.

- Each crest needs to be glued to ensure the adhesion performance.

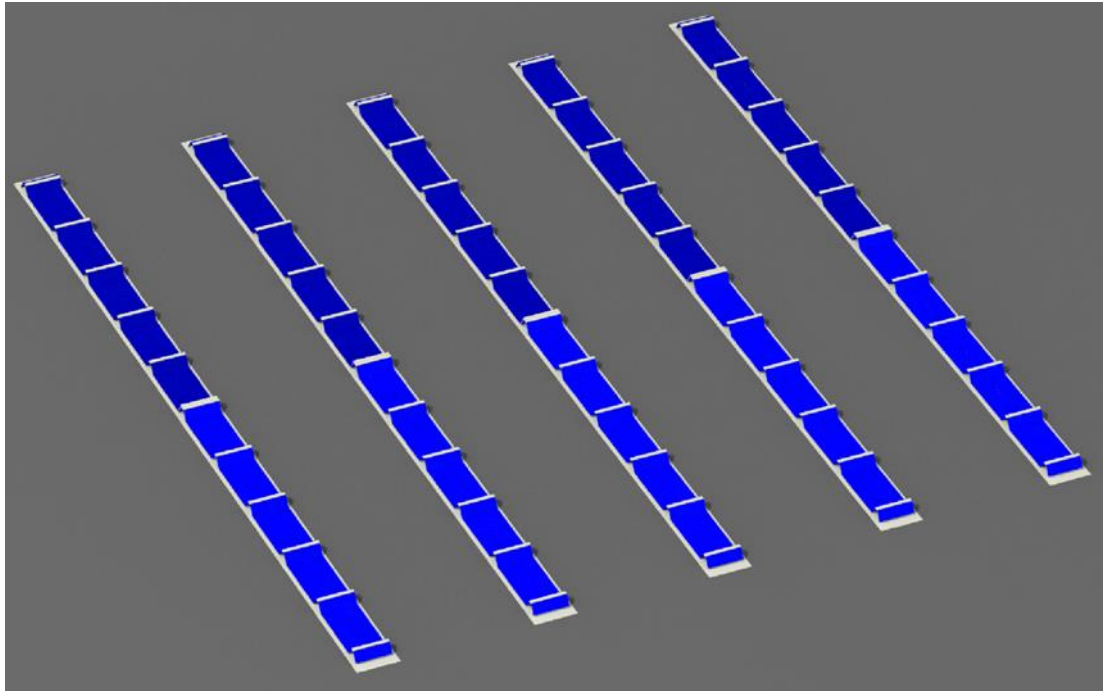

- Do not bend the module during installation. Two people should grasp the white edge of the module and place it onto the glue.
- Modules should be in a straight position during placement. Do not re-glue the modules.
- Once modules are placed, avoid hand-pressing the cell-area to facilitate adhesion. A plastic roller needs to be rolled over the surface of the module to ensure a good bond between the module and the CS.
- The minimum distance between the modules is 5mm, and the distance between each array is 500-800mm, which is used as a construction maintenance walkway. (This spacing is for reference only)
- Place the junction box on the maintenance walkway side for easy string wiring and maintenance inspection.
- Follow the steps above to install the other modules.

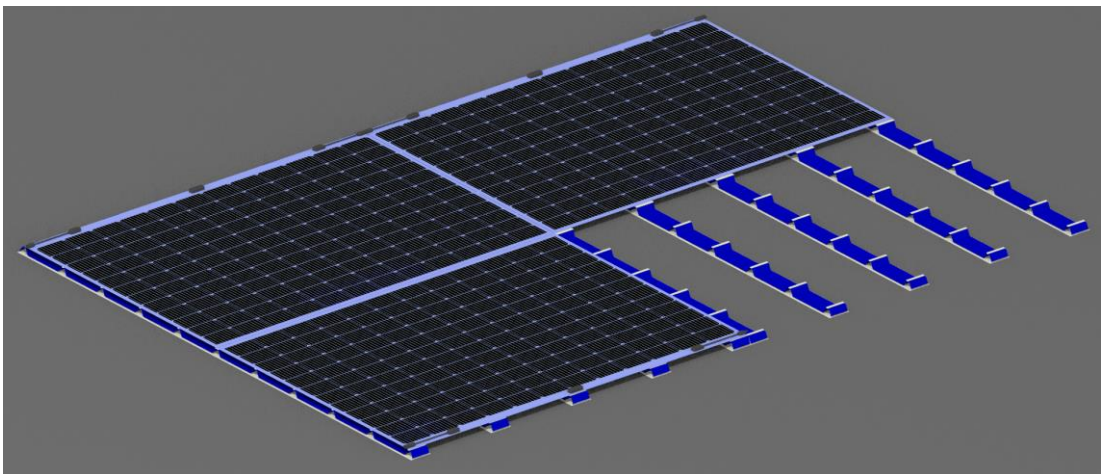
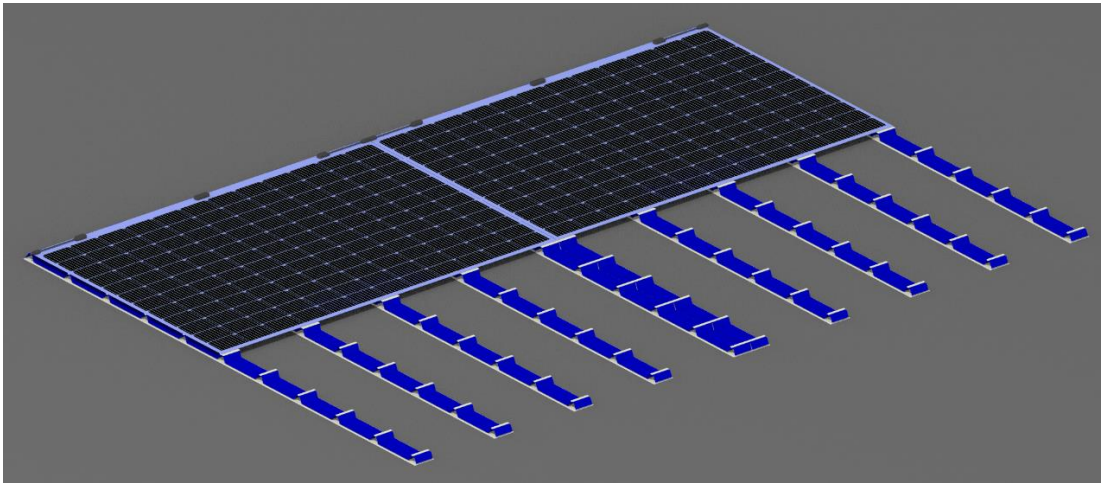
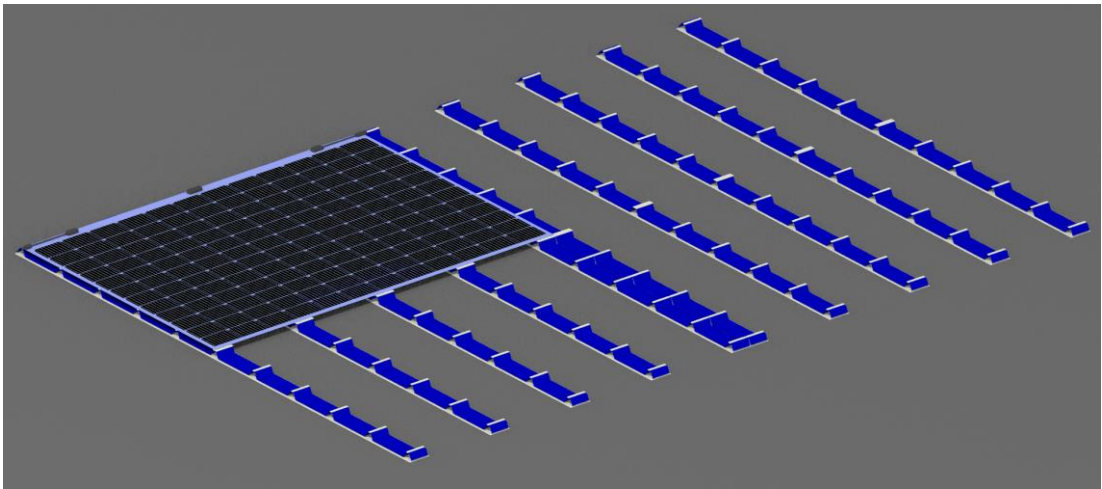

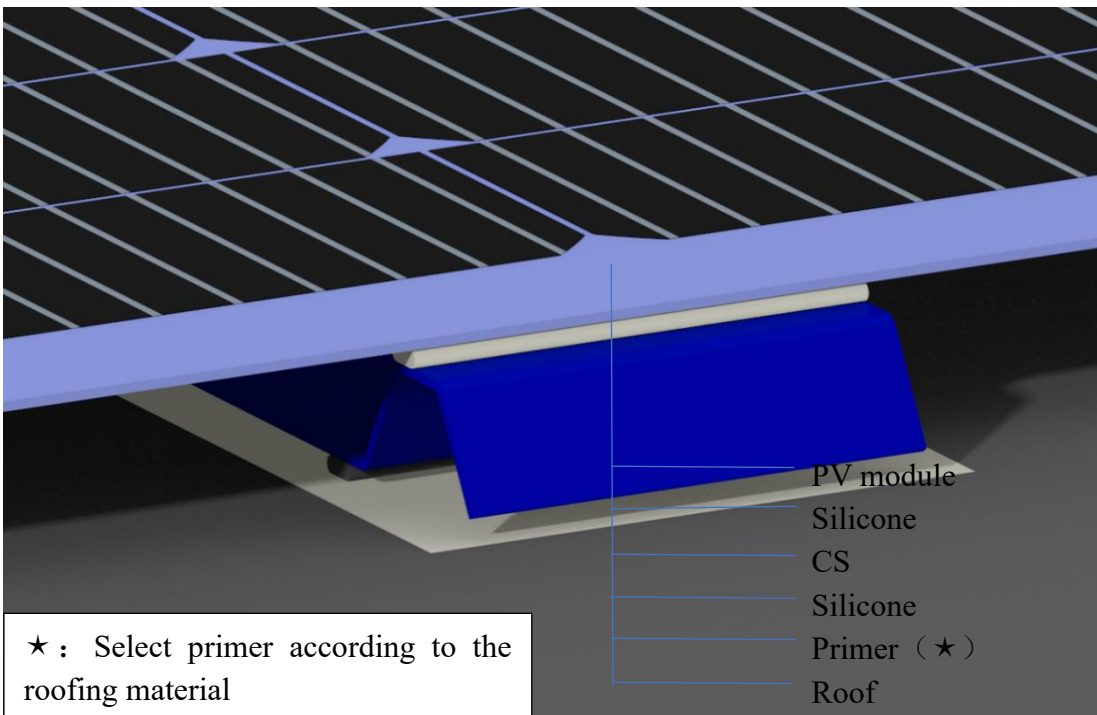
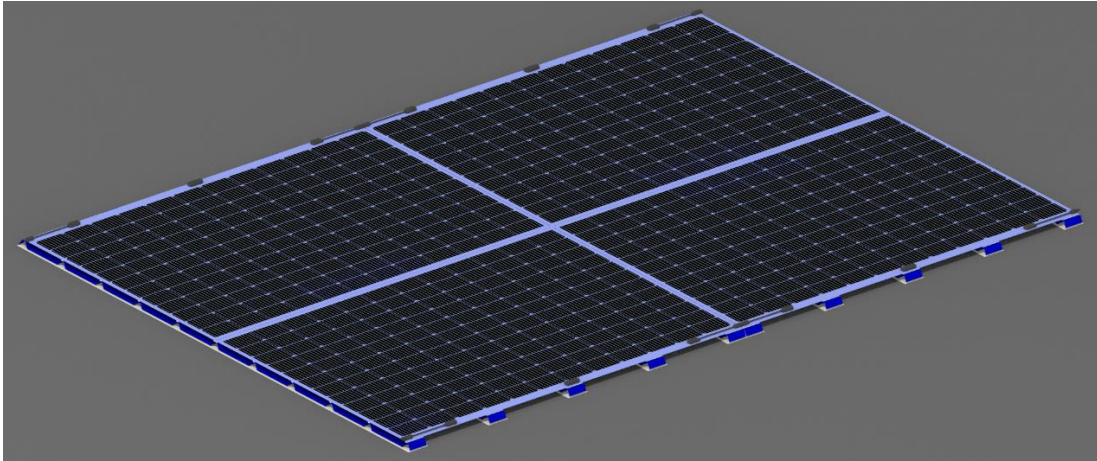

6.6 Wiring and testing

- 1) The use of PV modules with different configurations in a PV system is prohibited.
- 2) Excessive cables must be organized or fixed in the proper location.
- 3) For applications requiring high operating voltages, several PV modules may be connected in series to form a PV string, then the system voltage is equal to the sum of the voltages of each PV module
- 4) For applications requiring high operating currents, several strings of PV

modules can be connected in parallel to form a PV string, then the system current is equal to the sum of the currents of each PV module string.

- 5) A maximum system voltage of 1000VDC is allowed.
- 6) The maximum number of PV modules in series depends on the system design, the type of inverter used and the environmental conditions;
- 7) Depending on the maximum series fuse rating of the PV module and local electrical installation codes, if the PV module does not have any fuses or blocking diodes, make sure to connect no more than two strings in parallel;
- 8) There is no limit to the number of PV modules that can be connected in parallel (fuses per string should be considered), the number of PV modules is determined by system design parameters such as current or power output;
- 9) Please refer to local regulations to determine the size, type and temperature of the system conductors;
- 10) PV modules are equipped with connectors for system electrical connections, please refer to local regulations and data sheets that allow the use of connectors;
- 11) To ensure a reliable electrical connection and to prevent possible moisture ingress, connectors must fit and lock together until a click is heard;

The DC power generated by the PV system can be converted to AC power and connected to the public grid, as the local power company's policy for connecting renewable energy systems to the grid varies from region to region. You can ask your PV system design engineer or integrator for help in obtaining building permits, inspections and approvals from your local power company's department.

7.0 Maintenance

To ensure optimal performance of modules and maximize system power generation, the following maintenance measures are recommended:

1 Module appearance inspection, focusing on the following points:

- a) Whether the module is damaged.
- b) Whether there is a sharp object touching the surface of the module.
- c) Whether the modules are obstructed by obstacles and objects, avoiding new trees, new poles etc. to shielding the modules.
- d) Check for corrosion near the busbar. This kind of corrosion is caused by the damage of the module surface during transportation, which causes moisture to penetrate into the interior of the module.
- e) Check the adhesive between the module and the roof for looseness or damage and adjust or repair it in time.

2 Clean the modules. The accumulation of dust or dirt on the surface of the modules will reduce the power output. It should be cleaned regularly to keep the surface clean. Generally, it should be cleaned at least once a month, appropriately increase the frequency in the harsh natural environment. Pay attention when cleaning PV modules:

- a) Rinse with water first, then dry the water with a soft cloth. Do not use corrosive solvents to clean or wipe the PV modules with hard objects.
- b) The PV module should be cleaned at an irradiance of less than 200 W/m^2 . It should be cleaned in the absence of sunlight or in the morning and evening.
- c) It is strictly forbidden to clean PV modules under meteorological conditions where the wind is greater than grade 4, heavy rain or heavy snow.

Note: Do not walk, stand or sit on the module when cleaning.

3 Connector and cable inspection. It is recommended to conduct a preventive inspection every six months:

- a) Check for signs of aging of PV modules, including possible rodent damage, weathering, and whether all connectors are tightly connected or corroded.

Annex A

Electrical performance parameter

Series	Products	STC					module size
		Pmp	Vmp	Imp	Voc	Isc	
	SMF430F-12X12UW	430	42.0	10.24	49.8	10.74	2054*1084*2
	SMF430F-6X24UW	430	42.0	10.24	49.8	10.74	2120*1046*2

Annex B

Installation for different roof materials

Roof type	Primer needed	Primer type	Silicone type
TPO	Yes	Contact Sunman	Tonsan 1527
Concrete	Yes	Contact Sunman	Tonsan 1527
Glass	No		Tonsan 1527
PVC	No		DIMA MS8201

Annex C

Cleaning agent

Roof type	Cleaning agent recommended by Sunman
TPO, PVC, Asphalt, EPDM, etc. plastic roof	Plastic cleaner China: RA-1033 Overseas: Use the cleaning agent recommended by the roofing material supplier
Color steel tile, glass roof, metal roof	90% isopropanol + 10% water

Use the cleaners listed above or those recommended by the roofing material supplier.



Annex D

Gluing operation specification

1. Gluing nozzle cutting

The standard nozzle cutout is 10.5mm x 6mm, which is made by cutting about 20mm from the original nozzle and flattening it to the required size, as shown in the figure below.

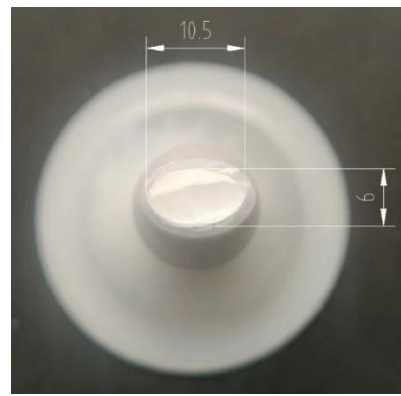

Nozzle cutting should be carried out in strict accordance with the following procedures.



Standard tool shears (complimentary with adhesive)

Operation steps

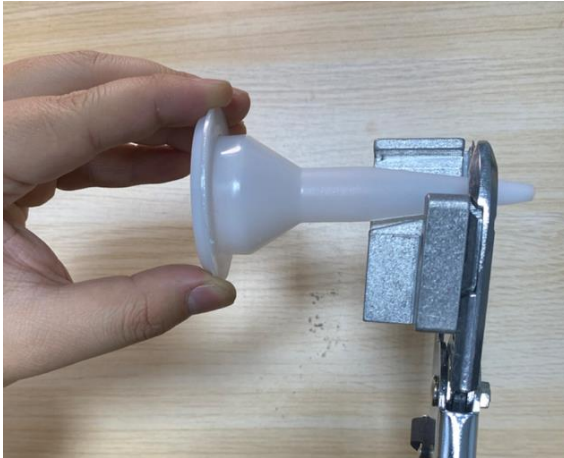

1. Use a straightedge or tape measure to measure the length of the head of the nozzle 20mm, confirm the cutting position, and then use the tool to cut in addition.



2. It is recommended to use a lighter to heat the tip of the rubber nozzle for about 2s to prevent it from springing back after being flattened.



3. Squeezing of the nozzle to the desired size using a flattening die of the tool shears.

2. Electric glue gun adjustment

Standard glue-out speed: Half turn of the speed knob, see the following figure:

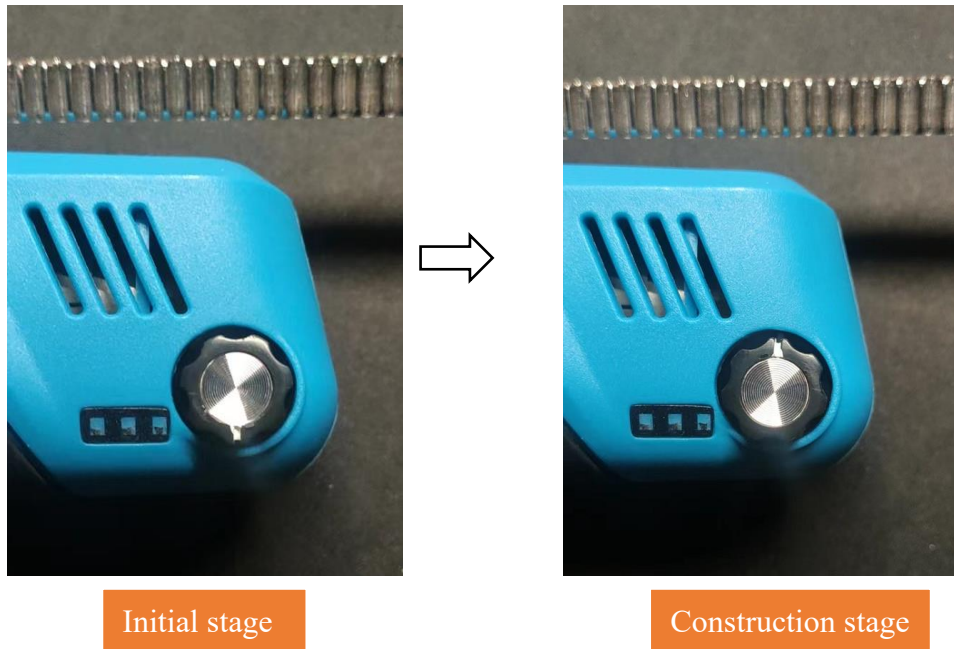

3. Gluing parameters

Gluing length: 10.8m/600ml on average

Gluing speed: about 10cm/s



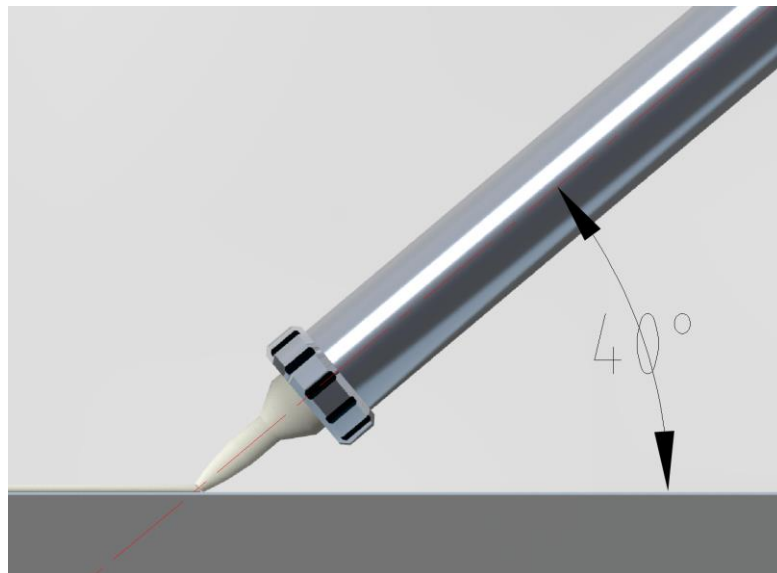



Gluing angle: the glue gun is at an angle of about 40° with the ground, as shown in the following figure:



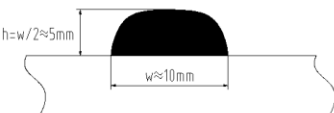



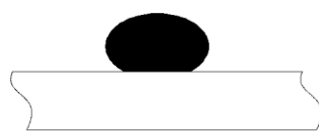

Adhesive size and standard dosage: at least 10*5mm; 5 strips/1 module (adhesive along the width of the PV module); 3 strips/1 module (adhesive along the length of the PV module)

4. Structural adhesive form

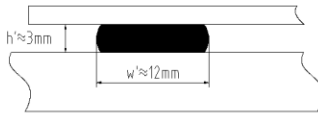
Please see below for proper bead application

	
 Correct dimension	 Too flat
	
 Too high, too small	 Poor wetting

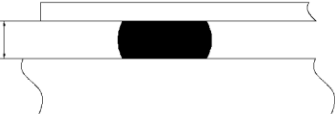
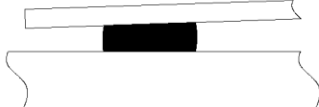
The correct form of structural adhesive after pasting modules

	
 Correct dimension	 Too flat
	
 Too high	 Inclined

Annex E

Unpacking

Standard unpacking steps for light weight PV modules.



1. Remove all wrapping film and packing tape outside the package



2. Remove packing box cover (keep well for another purpose)

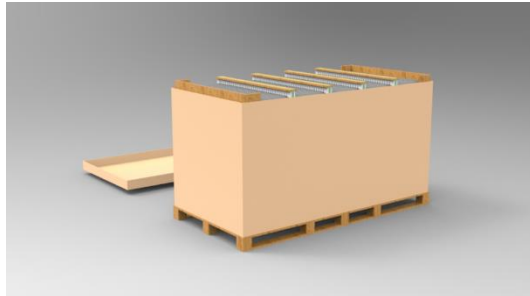

3. Place the cover next to the box with the opening up



4. Remove the outer packaging carton



4.1. Box cover retention (handling module auxiliary parts)



5、 Remove the upper fence on the side of the wooden box, keep the lower fence



6. Use scissors or a hobby knife to cut off the packing tape used to secure the module (do not cut the module)

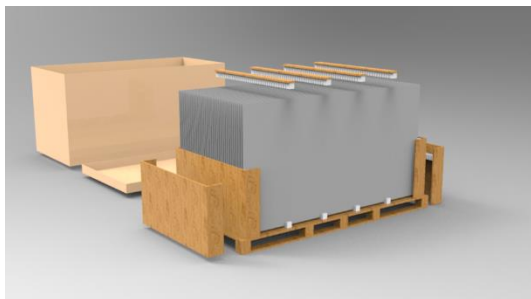
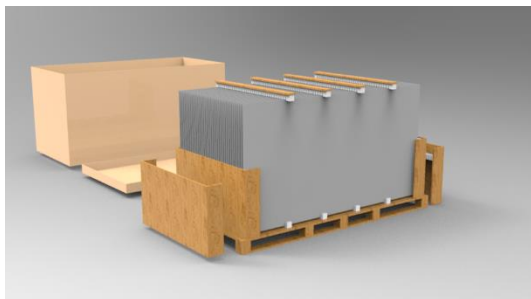

7. Remove the fixing clip above the module

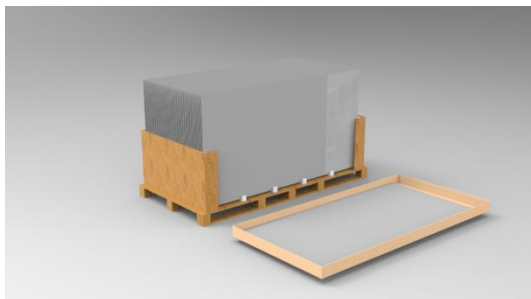
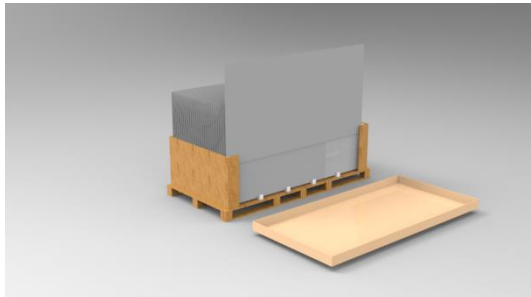
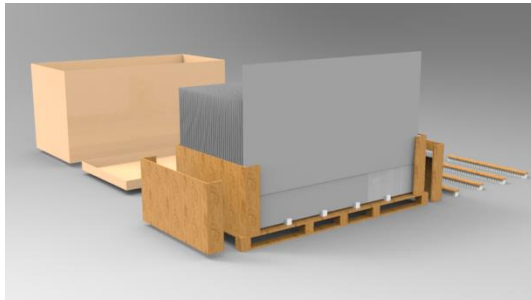
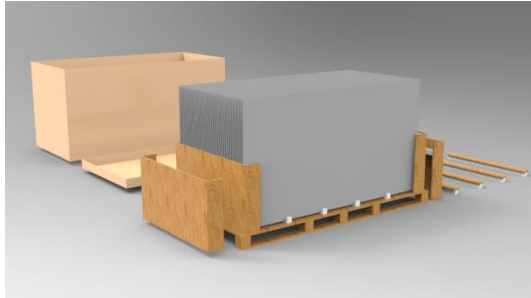

8、 To pick up the module, please raise the module to the height of the lower C-shaped enclosure and move out the module

When picking up the module, please grab the non-cell white area of the module.

When picking up the module, grab the long side direction of the module, the short side direction of the module can only be short grabbed again when out of the box operation

9、 Place the box cover open side up and transport the module flat inside the cover to the project designated installation site
Place a maximum of two modules in the cover, separated from each other with foam inside the box

Use a minimum of four foam strands, placed evenly between the stacked modules.

Module stacking and handling operations are as follows:

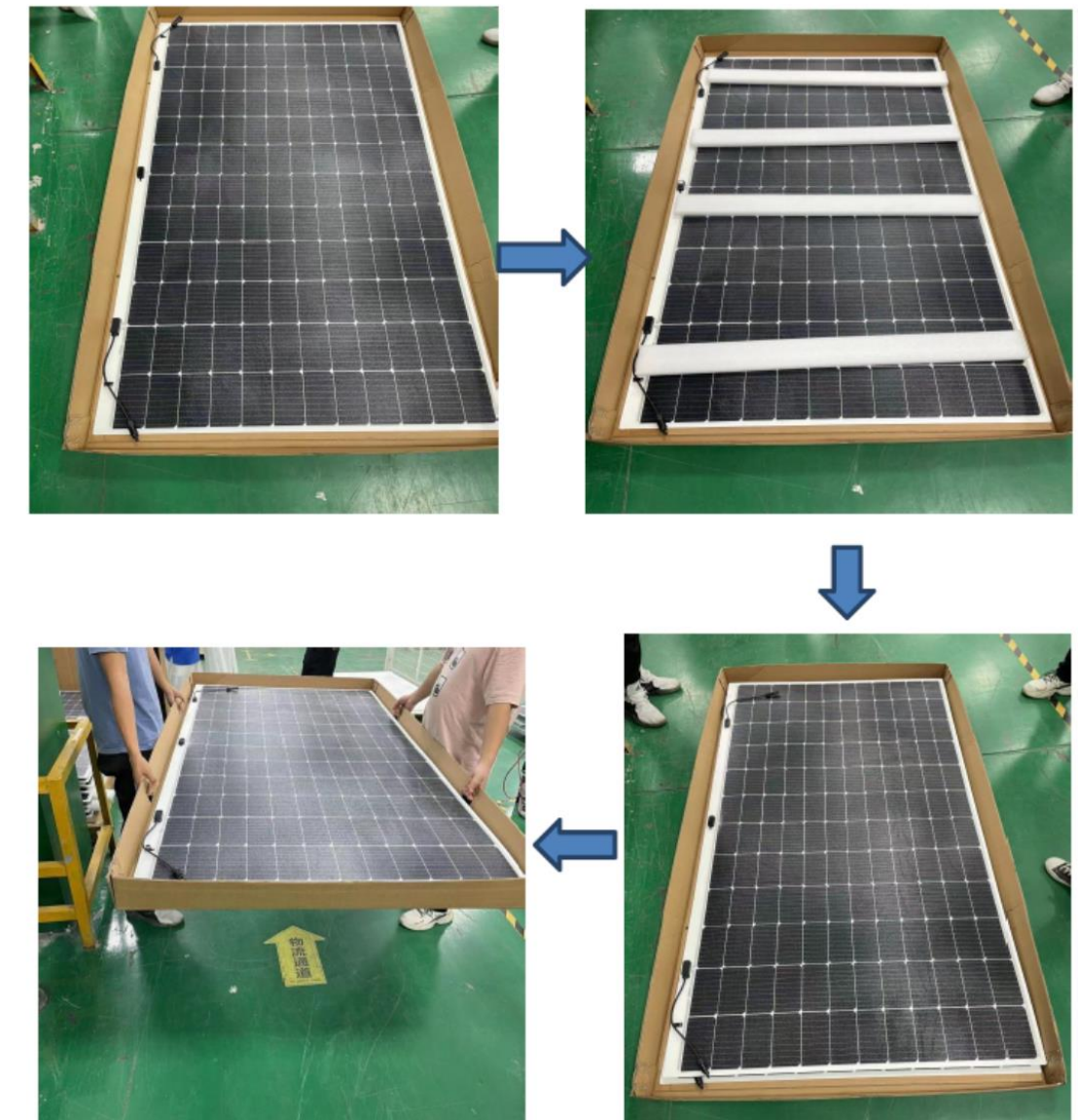

Unpacking precautions

Avoid operating in rainy weather when opening cartons outdoors.

Secure the modules when operating outdoors in windy conditions.

Stack components in a ventilated, rain-proof, and dry area before unpacking them.

Do not damage the front or back of the module when using scissors or hobby knife to cut the outer packing tape.

Confirm the number of modules in the box promptly after unpacking.

The unpacking area needs to ensure that the box is placed horizontally and stably to avoid tipping of the modules.



During unpacking and handling, please wear protective gloves properly to avoid scratches.

Prohibit pulling on junction boxes or cables under any circumstances.

When handle the modules, avoid touching the cell area with hands.

eArc SMF
Installation Manual
for Flat Roofs with CS
Tape

Contents

1.0 Summary.....	1
1.1 Disclaimer.....	1
1.2 Responsibility.....	1
1.3 Copyright and Trademark Information.....	1
1.4 Warranty Warnings.....	2
1.5 For Further Information.....	2
2.0 Safety precautions.....	2
3.0 Mechanical / electrical properties.....	4
4.0 Storage and unpacking.....	5
5.0 Installation.....	6
5.1 Module wiring.....	8
5.2 Grounding.....	8
6.0 Installation instructions.....	9
6.1 Module and tools.....	9
6.1.1 Module.....	9
6.1.2 Construction materials.....	9
6.2 Unpacking, Handling and Checking Precautions.....	10
6.3 Construction Precautions.....	11
6.4 Precautions and Tips for Gluing Modules.....	11
6.5 Construction plan.....	12
6.5.1 Cleaning the roof surface.....	12
6.5.2 Positioning and releasing the line.....	13
6.5.3 Brush primer (ignore this step if no primer required for the roof material)	14
6.5.4 Paste CS.....	15
6.5.5 Laying modules.....	17
6.6 Wiring and testing.....	19

7.0 Maintenance	21
Annex A	22
Electrical performance parameter	22
Annex B	23
Installation for different roof materials	23
Annex C	24
Cleaning agent	24
Annex D	25
Gluing operation specification	25
1. Gluing nozzle cutting	25
2. Electric glue gun adjustment	26
3. Gluing parameters	27
4. Structural adhesive form	28
Annex E	29
Unpacking	29

1.0 Summary

Thank you for purchasing Sunman eArc PV modules. This guide contains information regarding the installation and safe handling of Sunman (Zhenjiang) Company Limited eArc SMF PV system on Roofs. Sunman (Zhenjiang) Company Limited referred to as “SUNMAN”. Users and installers must read and strictly follow the installation manual. Failure to follow these safety guidelines can result in personal injury or property damage. The installation and operation of solar modules require specialized skills, and only professionals can do the job. Please read the safety and installation instructions before using and operating the modules. The installer must inform the end customer (or consumer) of the above matters accordingly.

1.1 Disclaimer

Sunman reserves the right to change this installation manual without prior notice. The changes and the latest installation manuals after the changes will be published in the resource center of the official Sunman website. Customers should always pay attention to the above changes. Sunman will not provide further notice.

Failure in operating according to instructions in this manual during installation (Including the changes announced on the official website of Sunman at the time of installation) will cause the warranty to be invalid.

Sunman does not guarantee any expressed or implied information contained in this manual.

1.2 Responsibility

Whether or not the installation of the modules is carried out in accordance with the instructions in the installation manual (Including the changes announced on the official website of Sunman at the time of installation), Sunman shall not be held legally responsible for any damages incurred during the installation process, including but not limited to personal and property damage resulting from the operation of the modules and the installation of the system.

1.3 Copyright and Trademark Information

Copyright © 2023 by Sunman (Zhenjiang) Company Limited. All rights reserved. eArc and the SUNMAN logo are trademarks of Sunman (Zhenjiang) Company Limited.

1.4 Warranty Warnings

WARRANTY VOID IF NON-SUNMAN-CERTIFIED HARDWARE IS ATTACHED TO eArc™ PV System.

1.5 For Further Information

For additional technical support documentation, please visit the Support page of the SUNMAN website at ‘www.sunman-energy.com’.

2.0 Safety precautions



WARNING: Please read and understand all safety instructions before installing, wiring, operating, or maintaining modules. DC power is generated when the module is exposed to sunlight or other light sources. Direct contact with live parts of the module, such as terminals, whether connected or not, may result in personal injury or death.

Safety rules

- All installation work must be in full compliance with local regulations and corresponding national or international electrical standards.
- Use insulated tools to reduce the risk of electric shock.
- Use appropriate protective measures (slip gloves, overalls, etc.) to avoid direct contact with workers at 30V DC or higher, while avoiding direct contact with sharp edges during installation to protect the operator's hands.
- Do not wear metal ornaments when installing, to avoid puncturing the modules and causing electric shock.
- If modules are installed or operated on rainy days, strong winds or dew mornings, appropriate protective measures should be taken to avoid injury to modules and workers.
- Children or unauthorized personnel are not allowed to access the installation area or module storage area.
- If the circuit breaker and overcurrent protection circuit breaker cannot be opened, or if the inverter cannot be turned off during the module installation or wiring, cover the array modules with opaque material to stop the power output.

- Do not use or install damaged modules.
- If the module surface is damaged or worn, direct contact with the surface of the module may result in electric shock.
- Do not attempt to repair any part of the module, there are no user-accessible components within the module.
- The cover of the junction box should remain closed at all times.
- Do not split the modules or move any part of the module.
- Do not artificially condense light on modules.
- Do not connect or disconnect modules when there is current in the module or external current.

3.0 Mechanical / electrical properties

The rated electrical performance data for the modules is measured under standard test conditions (STC) of irradiance of 1000 W/m², AM 1.5, and cell temperature of 25 °C. The specific electrical and mechanical performance parameters of Sunman eArc modules are included in Annex A of this installation manual. The main electrical performance parameters under STC conditions are also marked on the nameplate of each module. The maximum system voltage for all modules is 1000V.

In some cases, the current or voltage generated by the module may be greater than the optimal operating current or voltage of its standard test condition (STC). Therefore, when determining the component rating and load value, the module open circuit voltage and short circuit current at STC should be multiplied by 1.25. Please check with your local rules and regulations.

4.0 Storage and unpacking

Precautions and general safety rules

- Store modules in a dry and ventilated environment.
- The modules must be transported in the package provided by Sunman and stored in the original package before installation. Please protect the packaging from damage. Open the package according to the recommended unpacking steps. Care must be taken during unpacking, shipping, and storage.
- Do not apply excessive loads on the modules or twist the modules.
- Do not carry the modules through the wires or junction boxes of the modules.
- Do not stand, climb, walk or jump on modules.
- Do not allow sharp objects to touch the modules. Scratches can directly affect the safety of the modules.
- Do not place the modules in an environment where there is no reliable support or is not fixed.
- Do not change the wiring method of the bypass diode.
- Keep all electrical connections clean and dry.

Product identification

- Barcode: each individual eArc has a unique serial number. The serial number has 21 digits. The 1st to 4th digits are the module type for internal use, and 5th to 8th digits are the year code, and the 9th and 10th digits are the month code, and the 11th and the 12th digits are the week code, and the 13th and 14th digits are the month code, and the 15th to 17th digits are order number, and the 18th to 21th digits are the sequence codes. For example, xxxx20210415xxxxxxxx means the module was made in the 15th week of 2021. Each module has only one bar code. It is permanently attached to the interior of eArc and is visible from the top front of eArc. This bar code is inserted prior to lamination.



- There is a nameplate, which shows the model number, main electrical properties, safety specifications and certification indicator, on the back of each module.

5.0 Installation

Precautions and general safety rules

- Before installing the modules, please contact the relevant department to obtain information about the installation site and the construction permit, and also comply with the installation and inspection requirements.
- Check the applicable building codes to ensure that the building to be installed and its structure (roof, facade, load-bearing, etc.) has sufficient load-bearing capacity.
- During installation, make sure that the modules are installed on a fire-resistant roof. According to UL790 standards, Sunman eArc modules are rated as fire rating C.
- The eArc modules are compliant with application level A (equivalent to safety level II, IEC 61730-1). This type of modules can be used in systems where the public is likely to come into contact with voltages greater than 50V or power greater than 240W.

Environmental conditions

The modules are suitable for general climatic conditions, ie with reference to IEC 60721-2-1- Classification of environmental conditions Part 2-1: Environmental conditions occurring in nature - temperature and humidity.

- If the modules are used in a special installation environment, please consult the technical support department of Sunman in advance.
- The installation surface should be flat without bumps or pits.
- The modules must not be installed near flames or flammable objects.
- Do not expose modules to artificial condensing light sources
- The modules should not be immersed in water (pure water or salt water), installed in long-term water environment (pure water or salt water) (eg fountains, sprays, etc.) or area prone to water accumulation (eg roof drain, low-lying areas, etc.).
- Please consult SMF installation manual for Flat roofs if roof area has poor drainage or extended water pooling.
- If the module is placed in a salt mist (ie marine environment) or in an environment containing sulfur (ie, sulfur sources, volcanoes, etc.), there is a risk of corrosion.

- **Failure to follow the above precautions, Sunman Warranty will be voided.**

Installation requirements

- Ensure the modules meet the overall technical requirements of the system.
- Ensure that components of other systems do not cause damaging mechanical or electrical performance effects on the modules.
- Connect modules in series to increase voltage or in parallel to increase current. When connected in series, the positive pole of the module is connected to the next negative pole. When connected in parallel, the positive pole of the module is connected to the positive pole of the next module.
- The number of bypass diodes provided varies depending on the module model.
- Connect the appropriate number of modules according to the voltage specifications of the inverter used in the system. Even at the lowest local temperature conditions, the connected modules must produce no more than the voltage allowed by the system. If overcurrent protection devices (fuse) are not used in series within each string of modules, up to two strings of modules can be connected in parallel. If a suitable overcurrent protection device is connected in series with each string of modules, three strings or more modules can be connected in parallel.
- In order to avoid (or reduce) the mismatch effect of the array, it is recommended to connect modules of similar electrical performance on the same string.
- In order to reduce the risk of indirect lightning strikes, loops should be avoided when designing the system.
- The modules should be securely fastened to withstand all possible loads, including wind and snow loads.

Optimal orientation and inclination

- In order to achieve maximum annual power generation, the optimal orientation and inclination of the PV module should be determined first. The maximum electrical energy is typically generated when sunlight is directed onto the PV module.

Avoid shadows

- Even small shadows (such as dust) can cause a drop in power generation. If all surfaces of the module are uncovered throughout the year, the module is considered "no shadow". Ensure that the sun shines on the modules even on

the shortest day of radiation all through the year.

- EVA aging caused by frequent occlusion of modules and long-term heating of the diode can affect the lifetime of the module.

5.1 Module wiring

Correct electrical wiring

- Check that the wiring is correct before starting the system. If the measured open circuit voltage (Voc) and short circuit current (Isc) do not match the specifications provided, there may be a wiring fault.

Correct connection of the MC4 connector

- Make sure the MC4 connector is secure and properly connected. The MC4 connector must not be subjected to external pressure. The MC4 connector can only be used for circuit connection functions and should not be used to turn the circuit on and off.
- The MC4 connector should be kept dry and clean to prevent rain and moisture. Avoid direct sunlight and water soaking of the MC4 connector.

Use appropriate materials

- Depending on local fire, construction and electrical standard, use dedicated solar cables and suitable MC4 connectors to ensure the electrical and mechanical performance of the cable.
- The solar cable licensed for use is a single-wire cable, 2.5-10mm² (8-14 AWG), 90°C grade, with appropriate insulation to withstand the maximum possible system open circuit voltage. The appropriate wire size needs to be chosen to reduce the voltage drop. The wire should be made of copper.

Cable protection

- Secure the cable to the mounting system with a cable tie that is UV resistant. Appropriate measures should be taken to protect the exposed cable from damage (eg. in a plastic sleeve with UV aging resistance). Avoid direct exposure of the cable to direct sunlight.

5.2 Grounding

- With adhesive on the back of SMF modules and CS, there is no metal conductor for the module or the bracket, so no grounding of module is required.

6.0 Installation instructions

6.1 Module and tools

6.1.1 Module

Applicable module model: SMF430F-12X12UW, SMF430F-6X24UW

The electrical performance parameters are detailed in Annex A.

6.1.2 Construction materials

- CS, silicone sealant (glue), butyl tap, gluing gun, plastic roller, cleaning tool, tape measure, thread release tool, etc.

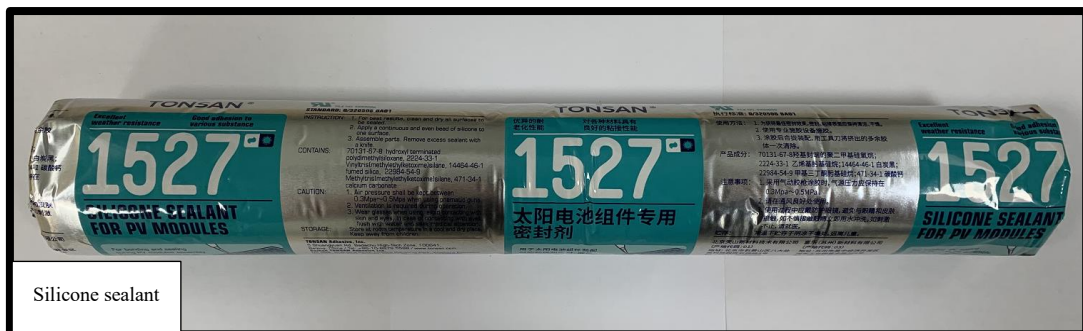
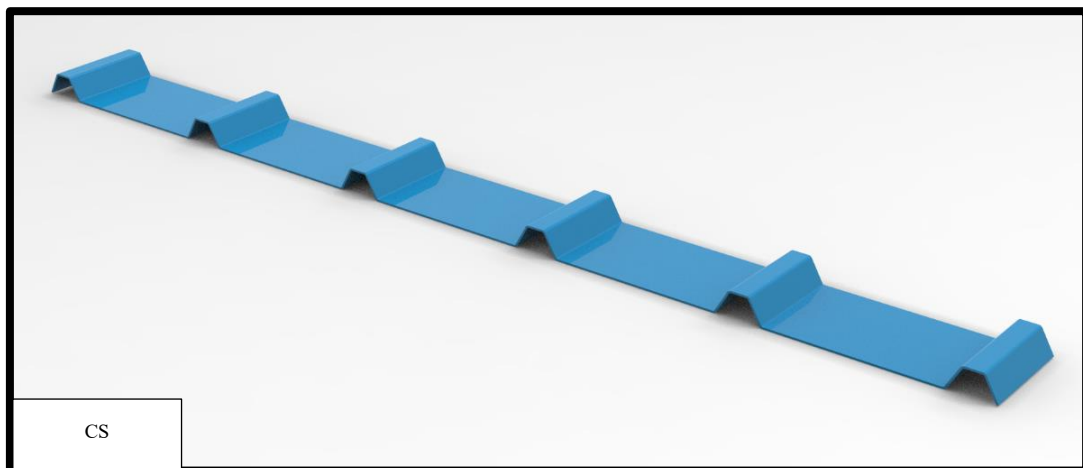



6.2 Unpacking, Handling and Checking Precautions

- Do not open modules outer Package before installation.
- Check the outer package for damage before unpacking.

- Slip-Proof Gloves are recommended for unpacking and handling.
- Do not grab the modules by the junction box or cables during unpacking or handling.
- Modules should be handled and lifted by at least two people. Do not touch the solar cell area during handling to avoid cell-cracks.
- Be careful while carrying the modules. Avoid hitting the modules on the ground or other sharp, hard objects. Scratches will affect the module's safe operation.
- Check the surfaces of the modules, make sure there's no damage to the frontsheet and the backsheet.
- Check the junction box, connectors, and cables for any damage. Double check if the junction box cover is fixed securely.
- Do not paint or apply glue or label on the surface of the modules.

6.3 Construction Precautions

- Normal construction can be carried out in the temperature range of -10 to 45 Celsius degrees (5 to 40 Celsius degrees is the best), and the humidity is below 80 %rh.
- The surface of the roof must be cleaned or wiped dry, free of floating soil, oil, etc. In order to achieve the required adhesion, the roof shall be cleaned using the cleaning agent specified in Annex C or Sunman- approved cleaning agent.
- After initial installation, the panel and adhesion shall not be disturbed for 24 hours.
- The roof angle is within 45 degrees.
- The paste surface needs to be flat and free of pits or bumps.
- The height of the structural adhesive after pasting should not be less than 3mm. Do not use feet or other non-designated tools to compact the structural adhesive.

6.4 Precautions and Tips for Gluing Modules

- Please make sure the surface is cleaned and there are no water pits before gluing;
- Glue along the middle line of the trapezoid or wave crest. Width of silicone glue strips should exceed 10 mm and height of the strips should exceed 5 mm

- Applying the silicone glue should be a continuous and even movement. Please use a roller to spread out the glue strips evenly. Do not smooth out the lines of glue to spread them out;
- Make sure to complete the gluing and mounting over a duration that does not exceed 5 minutes;
- Silicone sealant will cure to a depth of 2-3mm in 48 hours. Do NOT apply any force on the module before curing is complete;

6.5 Construction plan

Note: The installation steps are for TPO roofs, for reference only, different roof types can refer to this step for construction.

Installation steps

6.5.1 Cleaning the roof surface

Remove debris from the roof base and use a designated or approved cleaning agent (Annex C) to clean the roof. If the roof is very dirty, use a low-pressure water spray or power washer before using the cleaner. Optionally, use a mixture of 1/4 cup of trisodium phosphate, 1/2 cup of liquid cleaner and 5 gallons of water for cleaning.

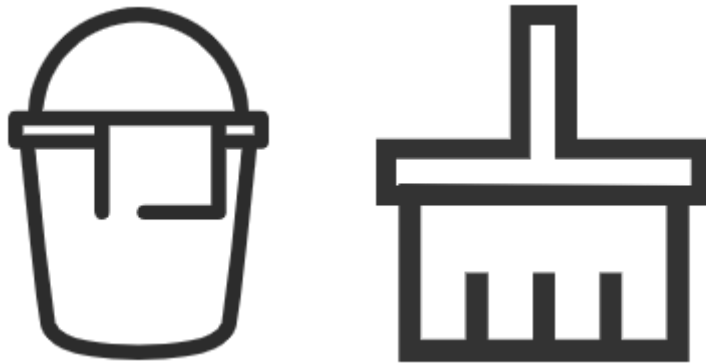

6.5.2 Positioning and securing the line



- Positioning and securing lines to determine the spacing of CS supports in accordance with the design drawings (For design drawings, please contact Sunman).





6.5.3 Brush primer (ignore this step if no primer required for the roof material)

- Determine the gluing area of the modules after the roof cleaning (refer to the design drawing for specific dimensions);

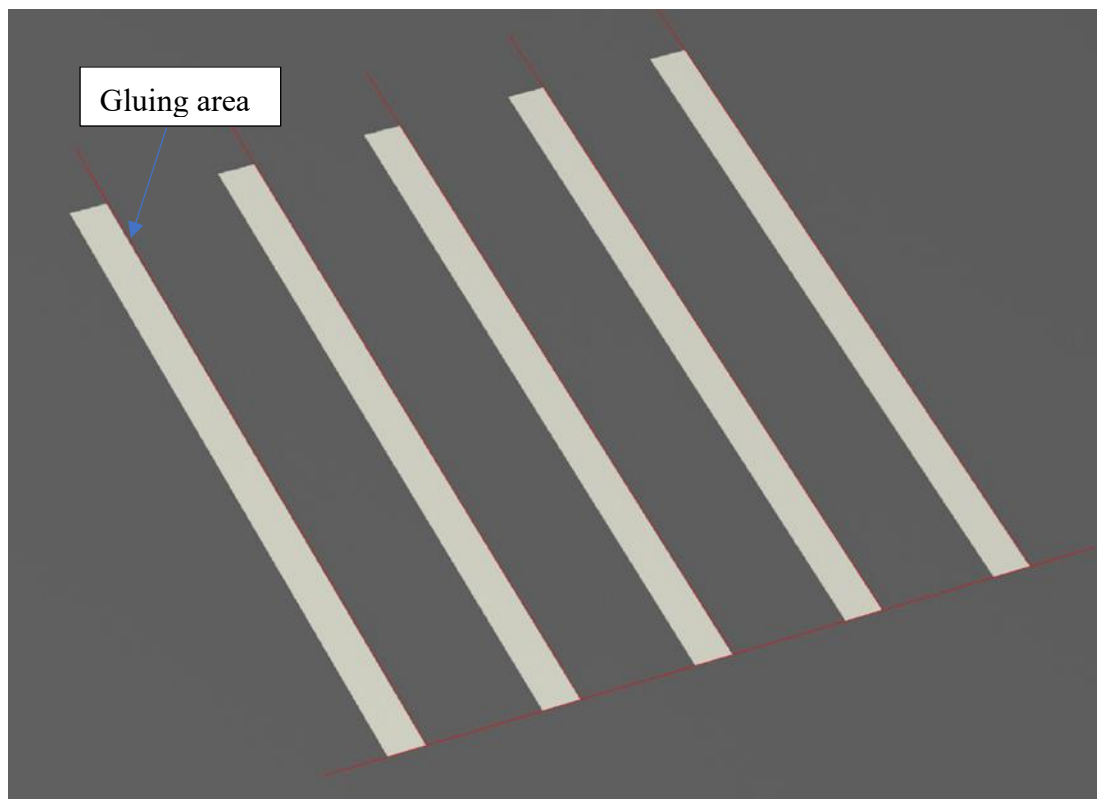

- Clean the gluing area again, wipe the area with the cleaning agent in Annex C;

- For the gluing area, brush primer before gluing to increase adhesion (see Annex B for different types of roof primer).

6.5.4 Paste CS

- Paste butyl tape, use a plastic roller to compress the tape to ensure the adhesive performance.

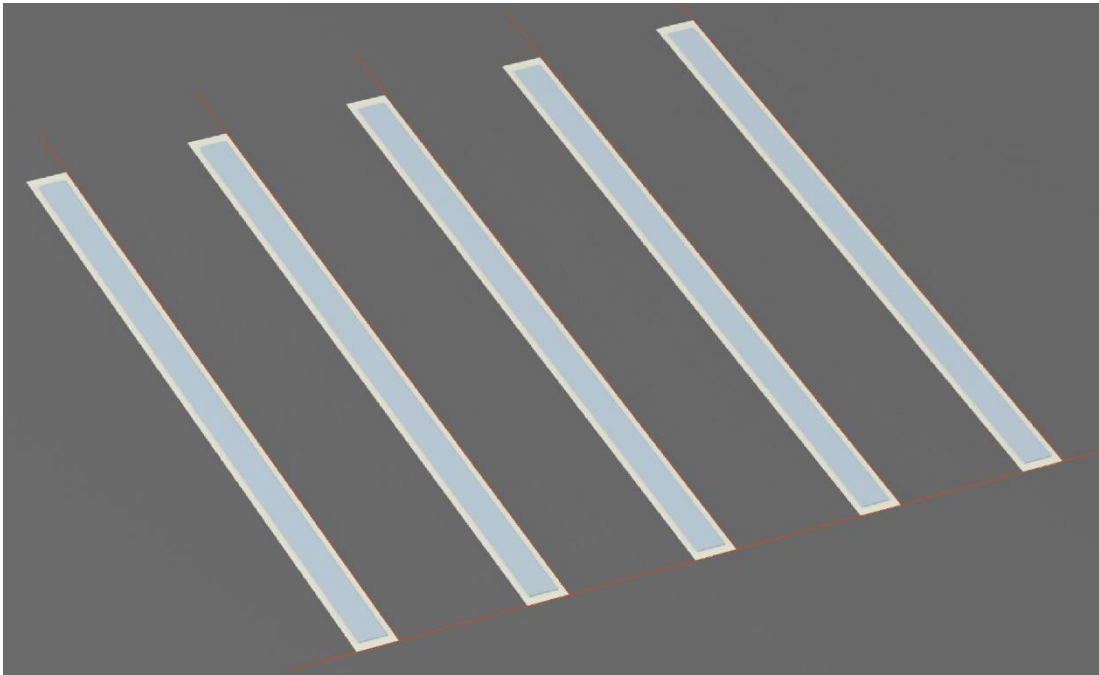

- Paste the CS on the butyl tape and ensure full contact with it.
- Overlap the crests of 2 adjacent CS supports, and use structural adhesive to paste the laps (as shown in the figure)

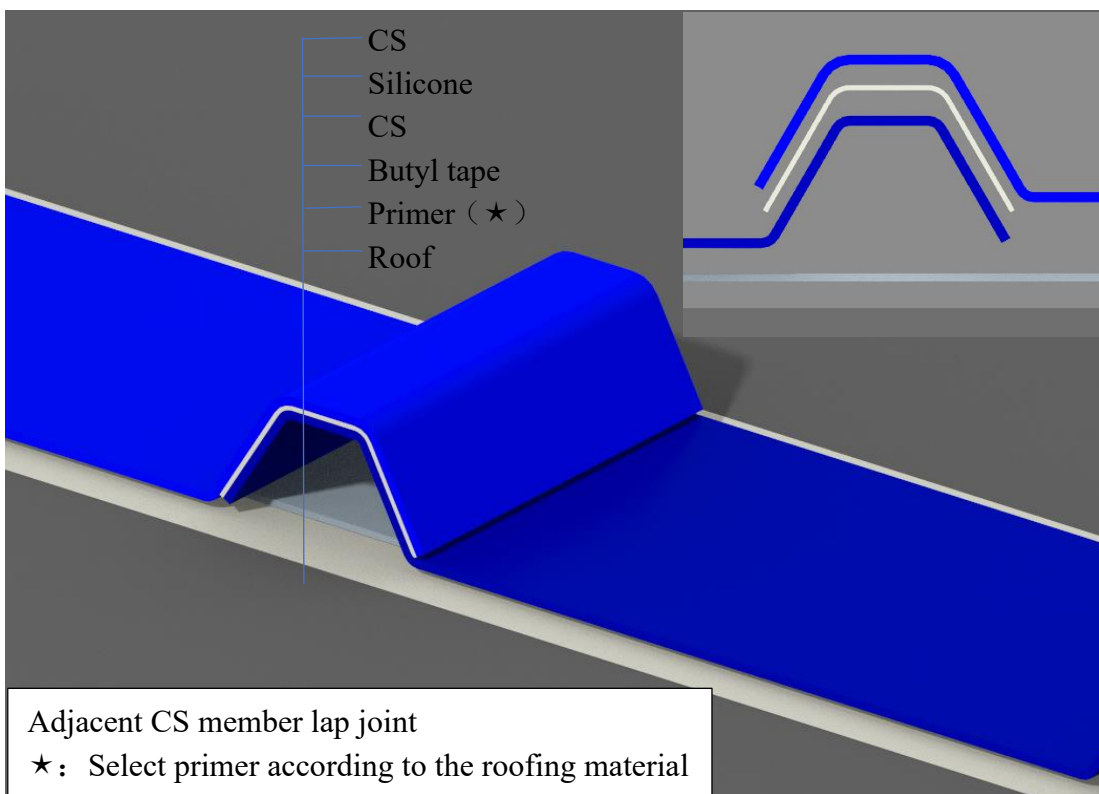
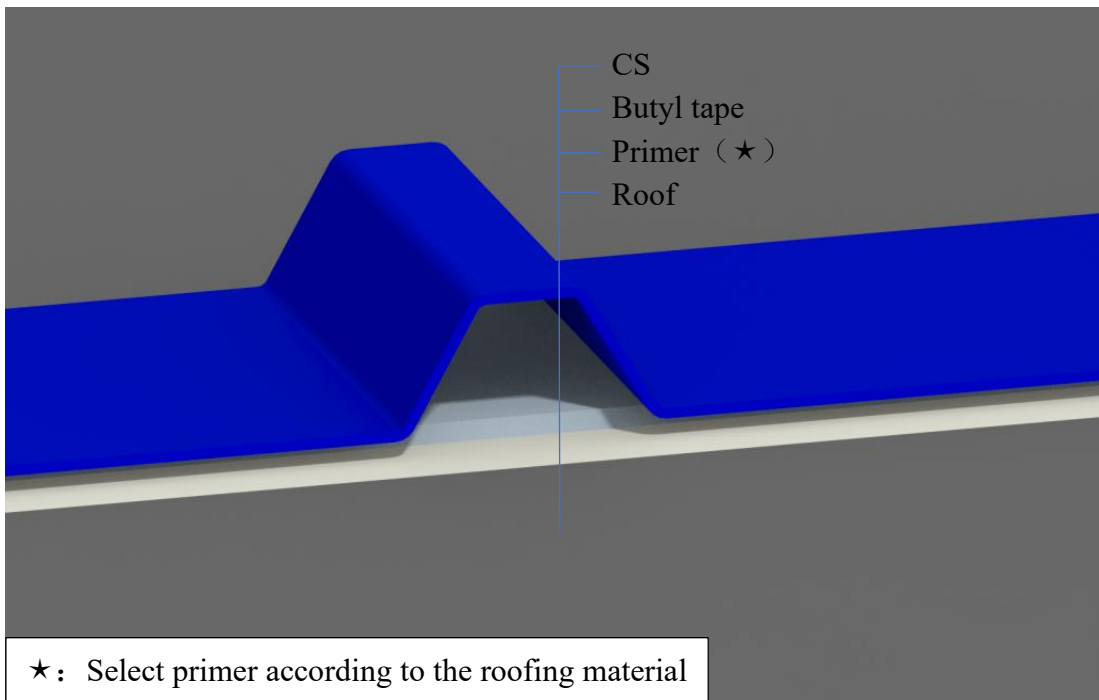

6.5.5 Laying modules

- Glue at the crest of the CS in accordance with the requirements of the gluing specification.
- Each crest needs to be glued to ensure the adhesion performance.

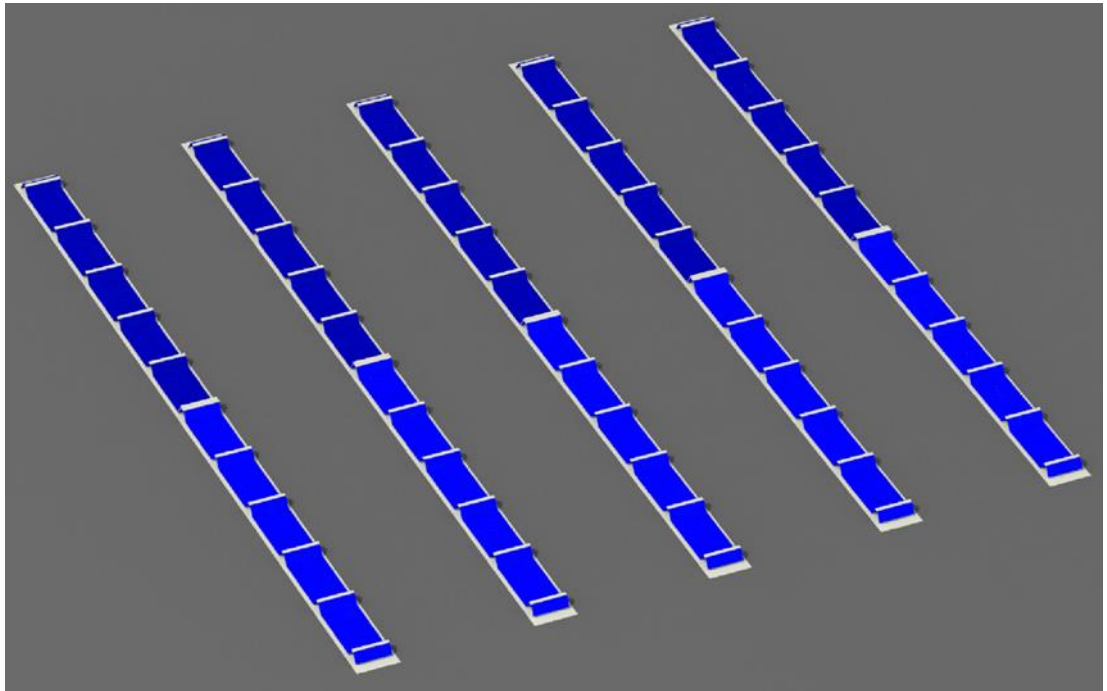

- Do not bend the module during installation. Two people should grasp the white edge of the module and place it onto the glue.
- Modules should be in a straight position during placement. Do not re-glue the modules.
- Once modules are placed, avoid hand-pressing the cell-area to facilitate adhesion. A plastic roller needs to be rolled over the surface of the module to ensure a good bond between the module and the CS.
- The minimum distance between the modules is 5mm, and the distance between each array is 500-800mm, which is used as a construction maintenance walkway. (This spacing is for reference only)
- Place the junction box on the maintenance walkway side for easy string wiring and maintenance inspection.
- Follow the steps above to install the other modules.

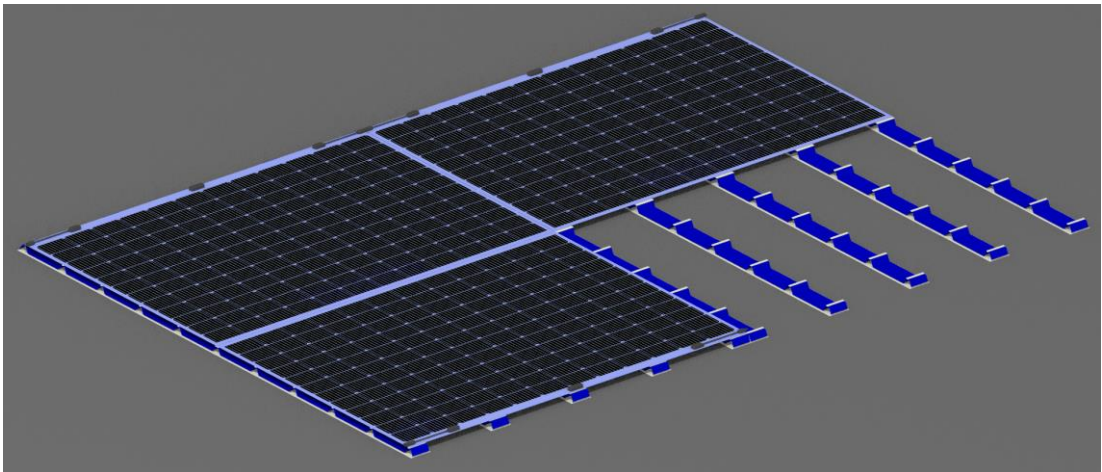
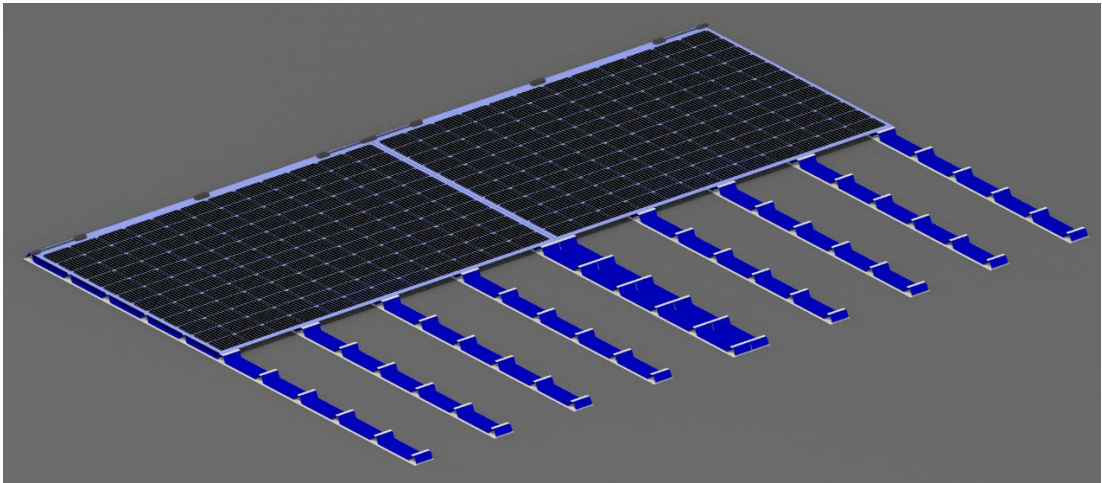
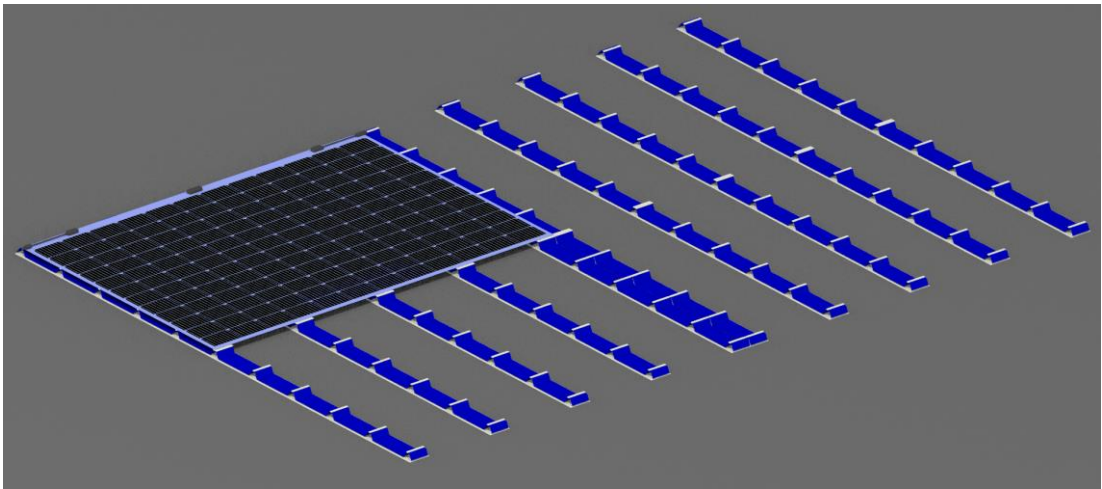

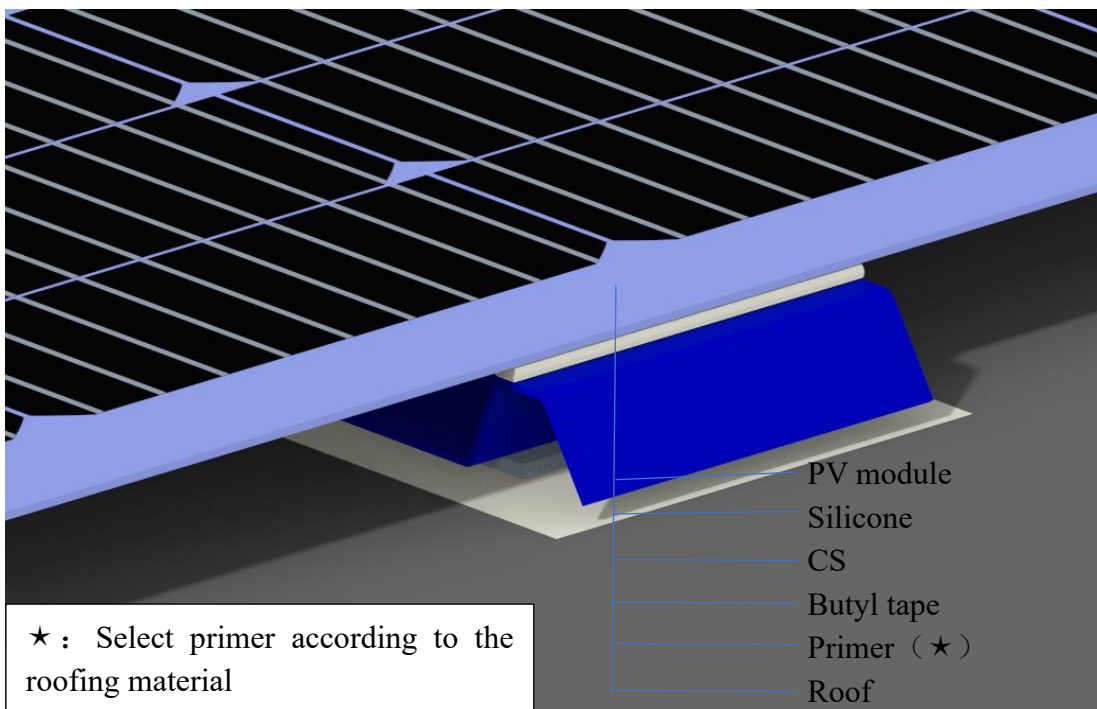
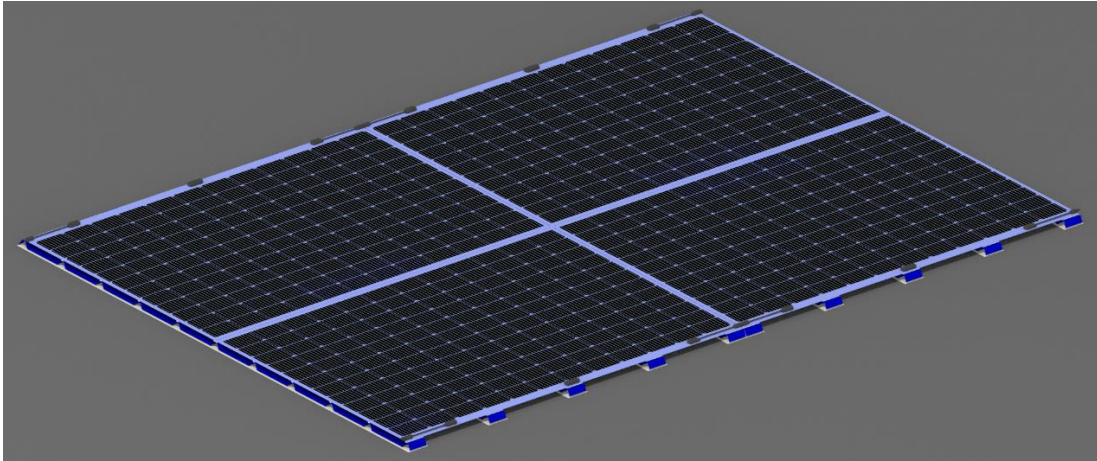

6.6 Wiring and testing

- 1) The use of PV modules with different configurations in a PV system is prohibited.
- 2) Excessive cables must be organized or fixed in the proper location.
- 3) For applications requiring high operating voltages, several PV modules may be connected in series to form a PV string, then the system voltage is equal to the sum of the voltages of each PV module
- 4) For applications requiring high operating currents, several strings of PV modules can be connected in parallel to form a PV string, then the system current is equal

to the sum of the currents of each PV module string.

- 5) A maximum system voltage of 1000VDC is allowed.
- 6) The maximum number of PV modules in series depends on the system design, the type of inverter used and the environmental conditions;
- 7) Depending on the maximum series fuse rating of the PV module and local electrical installation codes, if the PV module does not have any fuses or blocking diodes, make sure to connect no more than two strings in parallel;
- 8) There is no limit to the number of PV modules that can be connected in parallel (fuses per string should be considered), the number of PV modules is determined by system design parameters such as current or power output;
- 9) Please refer to local regulations to determine the size, type and temperature of the system conductors;
- 10) PV modules are equipped with connectors for system electrical connections, please refer to local regulations and data sheets that allow the use of connectors;
- 11) To ensure a reliable electrical connection and to prevent possible moisture ingress, connectors must fit and lock together until a click is heard;

The DC power generated by the PV system can be converted to AC power and connected to the public grid, as the local power company's policy for connecting renewable energy systems to the grid varies from region to region. You can ask your PV system design engineer or integrator for help in obtaining building permits, inspections and approvals from your local power company's department.

7.0 Maintenance

To ensure optimal performance of modules and maximize system power generation, the following maintenance measures are recommended:

1 Module appearance inspection, focusing on the following points:

- a) Whether the module is damaged.
- b) Whether there is a sharp object touching the surface of the module.
- c) Whether the modules are obstructed by obstacles and objects, avoiding new trees, new poles etc. to shielding the modules.
- d) Check for corrosion near the busbar. This kind of corrosion is caused by the damage of the module surface during transportation, which causes moisture to penetrate into the interior of the module.
- e) Check the adhesive between the module and the roof for looseness or damage and adjust or repair it in time.

2 Clean the modules. The accumulation of dust or dirt on the surface of the modules will reduce the power output. It should be cleaned regularly to keep the surface clean. Generally, it should be cleaned at least once a month, appropriately increase the frequency in the harsh natural environment. Pay attention when cleaning PV modules:

- a) Rinse with water first, then dry the water with a soft cloth. Do not use corrosive solvents to clean or wipe the PV modules with hard objects.
- b) The PV module should be cleaned at an irradiance of less than 200 W/m^2 . It should be cleaned in the absence of sunlight or in the morning and evening.
- c) It is strictly forbidden to clean PV modules under meteorological conditions where the wind is greater than grade 4, heavy rain or heavy snow.

Note: Do not walk, stand or sit on the module when cleaning.

3 Connector and cable inspection. It is recommended to conduct a preventive inspection every six months:

- a) Check for signs of aging of PV modules, including possible rodent damage, weathering, and whether all connectors are tightly connected or corroded.

Annex A

Electrical performance parameter

Series	Products	STC					module size
		Pmp	Vmp	Imp	Voc	Isc	
	SMF430F-12X12UW	430	42.0	10.24	49.8	10.74	2054*1084*2
	SMF430F-6X24UW	430	42.0	10.24	49.8	10.74	2120*1046*2

Annex B

Installation for different roof materials

Roof type	Primer needed	Primer type	Adhesive type
TPO	No	\	Butyl tape
Bitumen	Yes	Contact Sunman	Butyl tape
Glass	No	\	Butyl tape

Annex C

Cleaning agent

Roof type	Cleaning agent recommended by Sunman
TPO, PVC, Bitumen, EPDM, etc. plastic roof	Plastic cleaner China: RA-1033 Overseas: Use the cleaning agent recommended by the roofing material supplier
glass roof, metal roof	90% isopropanol + 10% water

Use the cleaners listed above or those recommended by the roofing material supplier.



Annex D

Gluing operation specification

1. Gluing nozzle cutting

The standard nozzle cutout is 10.5mm x 6mm, which is made by cutting about 20mm from the original nozzle and flattening it to the required size, as shown in the figure below.

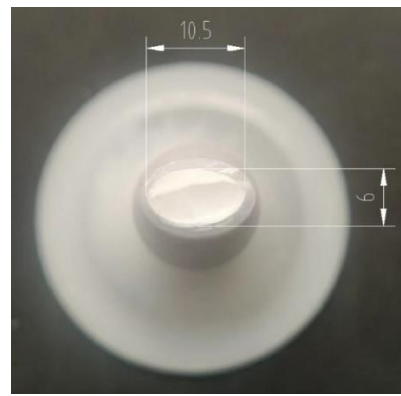

Nozzle cutting should be carried out in strict accordance with the following procedures.



Standard tool shears (complimentary with adhesive)

Operation steps



1. Use a straightedge or tape measure to measure the length of the head of the nozzle 20mm, confirm the cutting position, and then use the tool to cut in addition.



2. It is recommended to use a lighter to heat the tip of the rubber nozzle for about 2s to prevent it from springing back after being flattened.

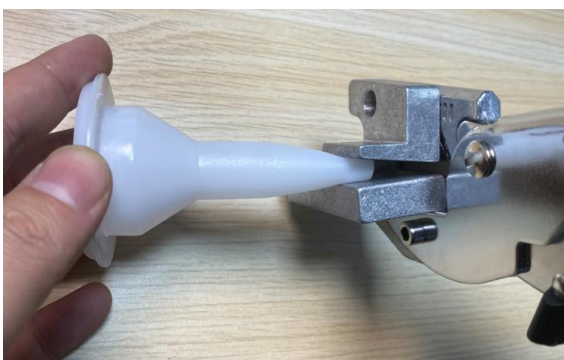

3. Squeezing of the nozzle to the desired size using a flattening die of the tool shears.

2. Electric glue gun adjustment

Standard glue-out speed: Half turn of the speed knob, see the following figure:

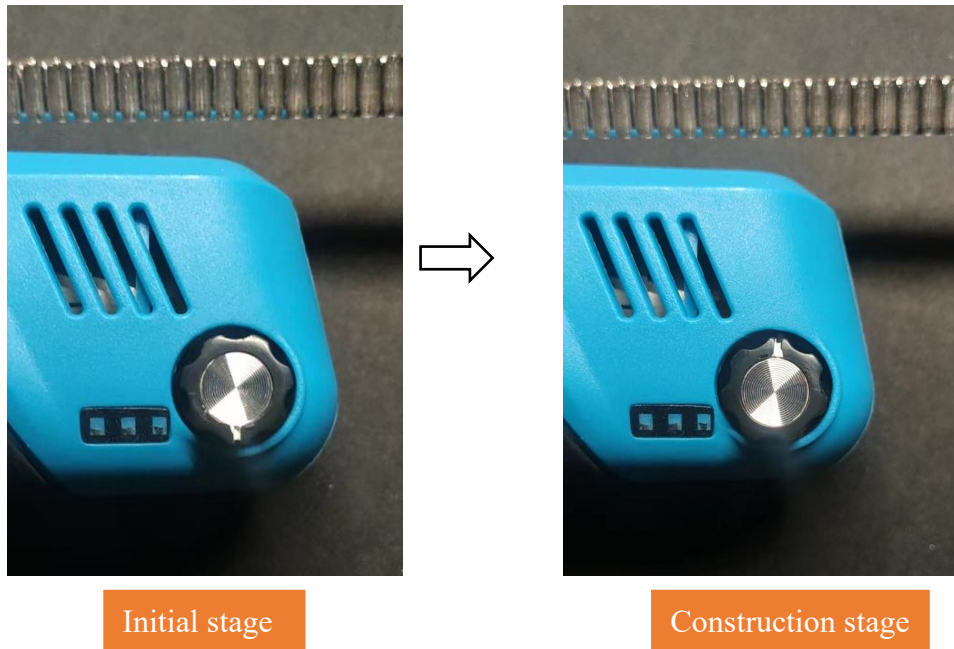

3. Gluing parameters

Gluing length: 10.8m/600ml on average

Gluing speed: about 10cm/s



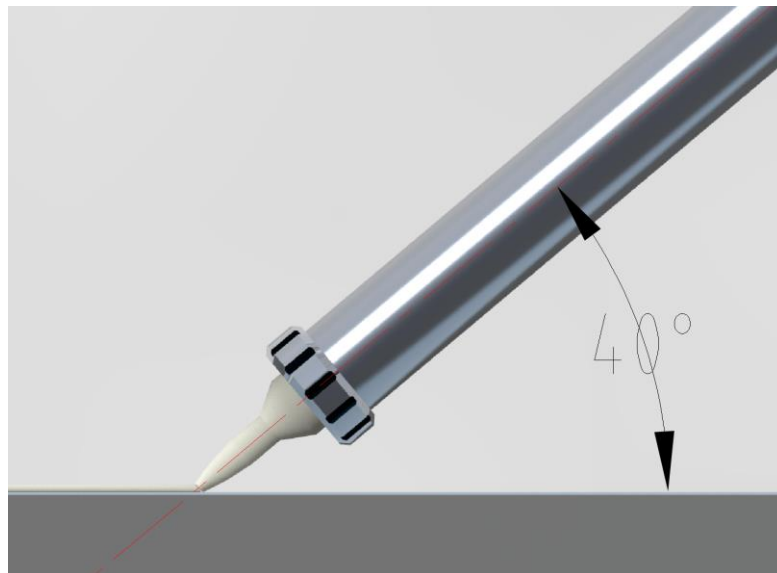





Gluing angle: the glue gun is at an angle of about 40° with the ground, as shown in the following figure:

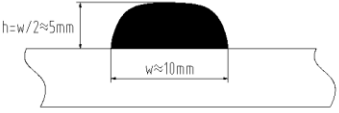







Adhesive size and standard dosage: at least 10*5mm; 5 strips/1 module (adhesive along the width of the PV module); 3 strips/1 module (adhesive along the length of the PV module)

4. Structural adhesive form

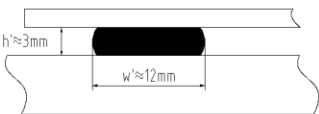
Please see below for proper bead application

	
 Correct dimension	 Too flat
	
 Too high, too small	 Poor wetting

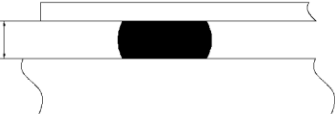
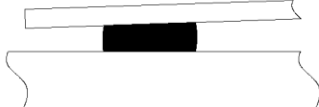
The correct form of structural adhesive after pasting modules

	
 Correct dimension	 Too flat
	
 Too high	 Inclined

Annex E

Unpacking

Standard unpacking steps for light weight PV modules.



1. Remove all wrapping film and packing tape outside the package



2. Remove packing box cover (keep well for another purpose)

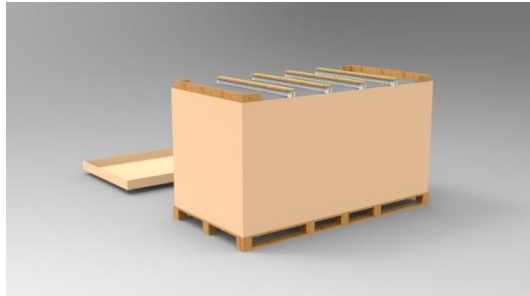

3. Place the cover next to the box with the opening up



4. Remove the outer packaging carton



4.1. Box cover retention (handling module auxiliary parts)



5. Remove the upper fence on the side of the wooden box, keep the lower fence

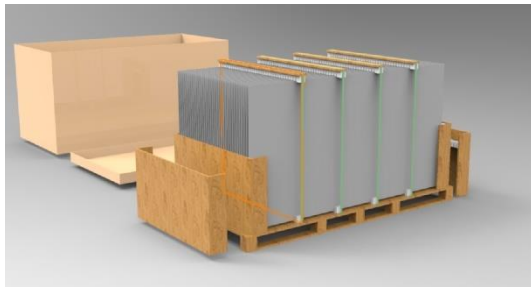
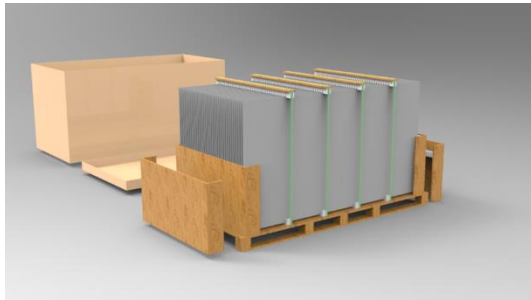

6. Use scissors or a hobby knife to cut off the packing tape used to secure the module (do not cut the module)

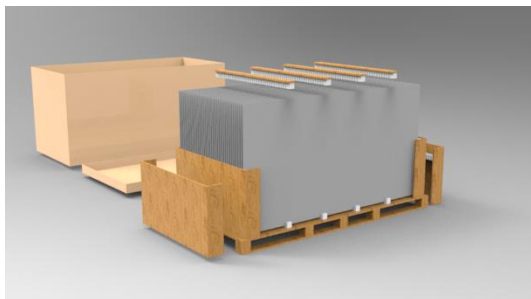
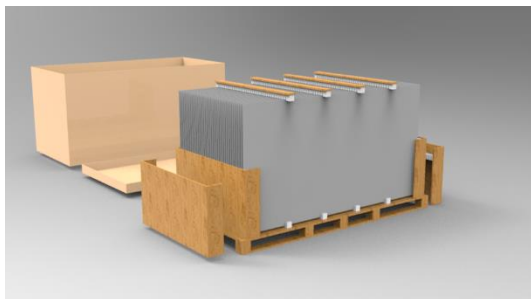

7. Remove the fixing clip above the module

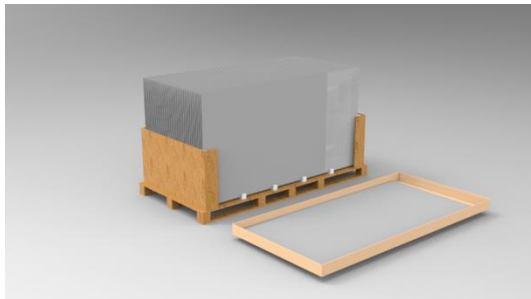
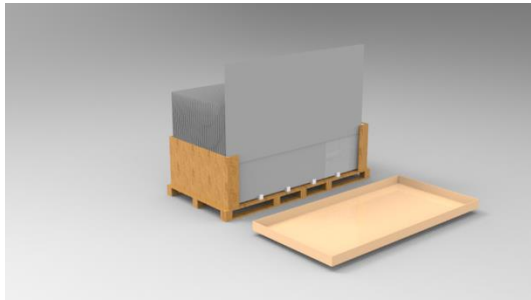
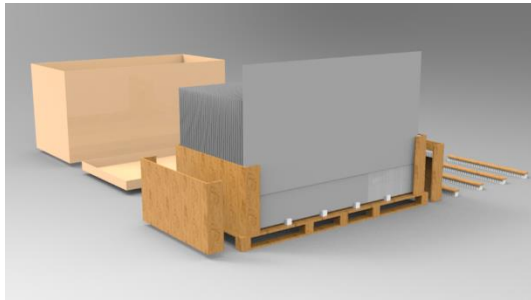
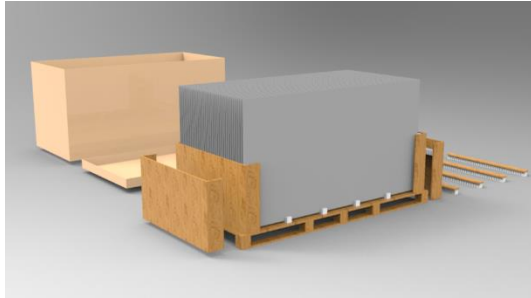

8、 To pick up the module, please raise the module to the height of the lower C-shaped enclosure and move out the module

When picking up the module, please grab the non-cell white area of the module.

When picking up the module, grab the long side direction of the module, the short side direction of the module can only be short grabbed again when out of the box operation

9、 Place the box cover open side up and transport the module flat inside the cover to the project designated installation site
Place a maximum of two modules in the cover, separated from each other with foam inside the box

Use a minimum of four foam strands, placed evenly between the stacked modules.

Module stacking and handling operations are as follows:

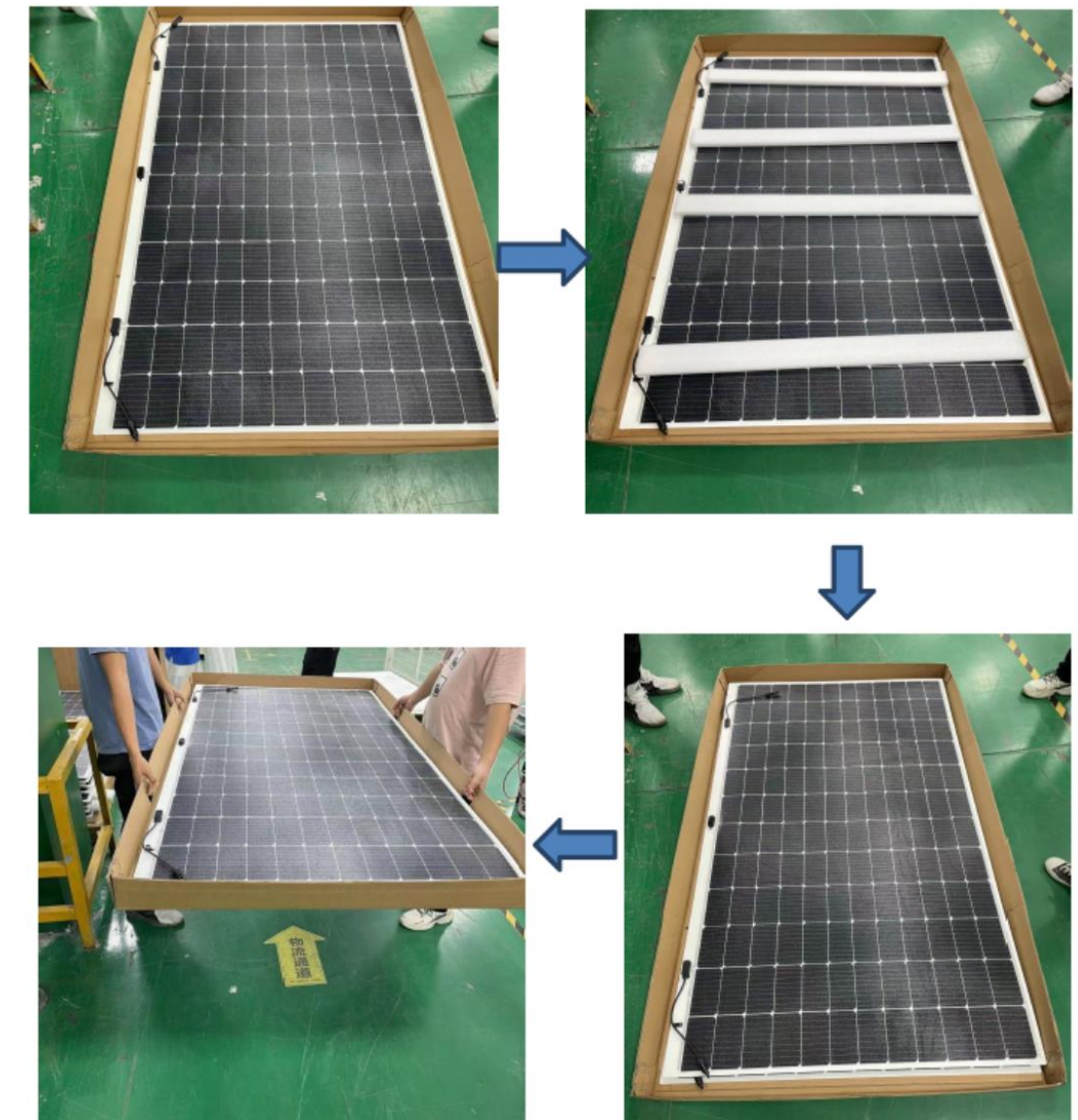

Unpacking precautions

Avoid operating in rainy weather when opening cartons outdoors.

Secure the modules when operating outdoors in windy conditions.

Stack components in a ventilated, rain-proof, and dry area before unpacking them.

Do not to damage the front or back of the module when using scissors or hobby knife to cut the outer packing tape.

Confirm the number of modules in the box promptly after unpacking.

The unpacking area needs to ensure that the box is placed horizontally and stably to avoid tipping of the modules.



During unpacking and handling, please wear protective gloves properly to avoid scratches.

Prohibit pulling on junction boxes or cables under any circumstances.

When handle the modules, avoid touching the cell area with hands.