



**FACTORX 80/90 PIVOTANTE**

**FAC595**

**(78.5-80)X200cm**

**FAC596**

**(88.5-90)X200cm**

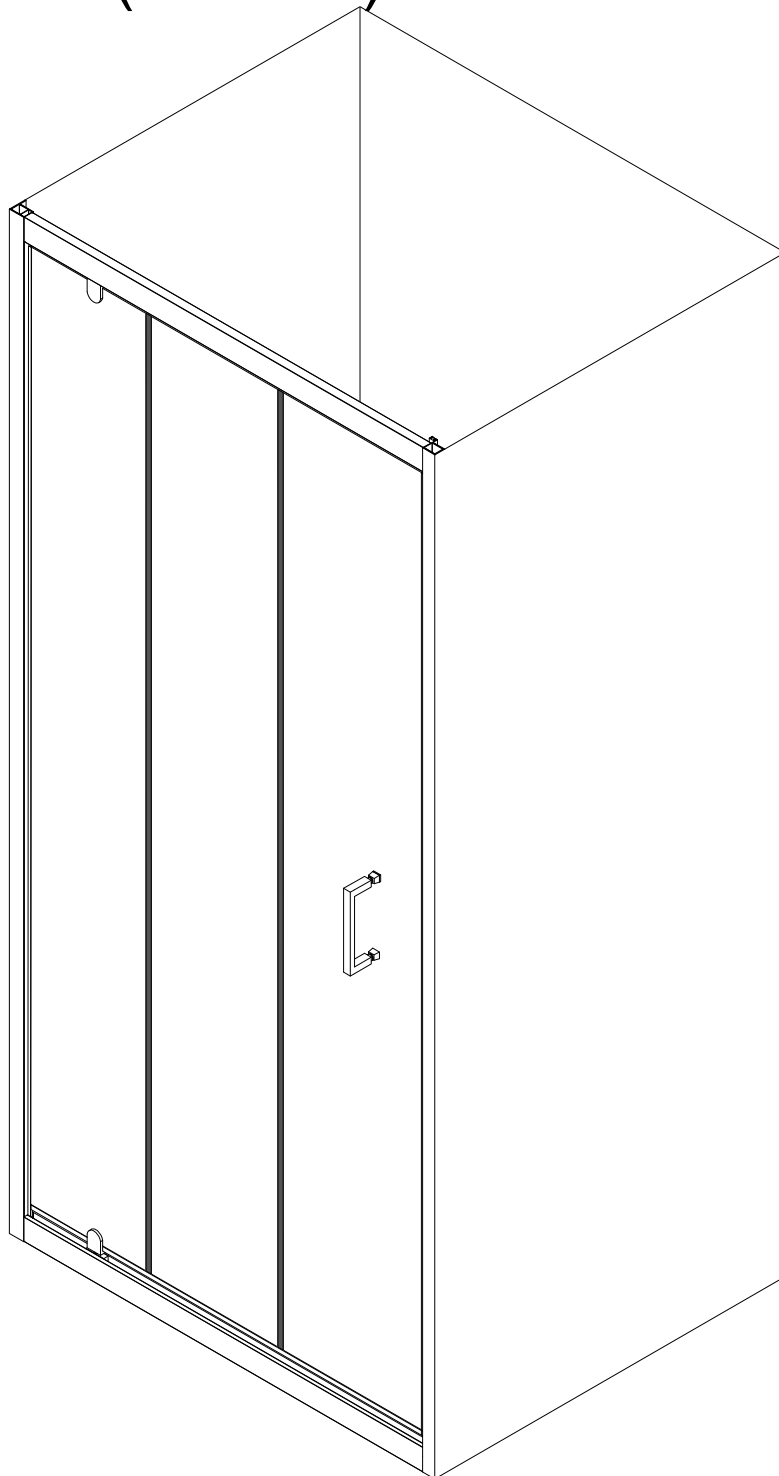

[www.aurlane.com](http://www.aurlane.com)

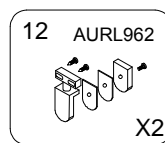
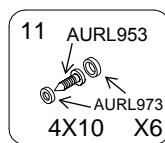
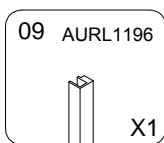
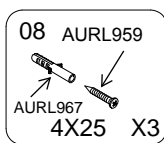
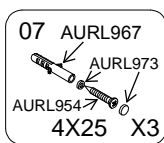
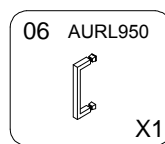
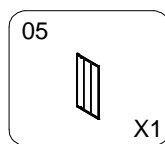
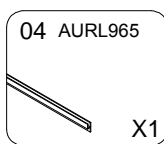
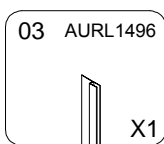
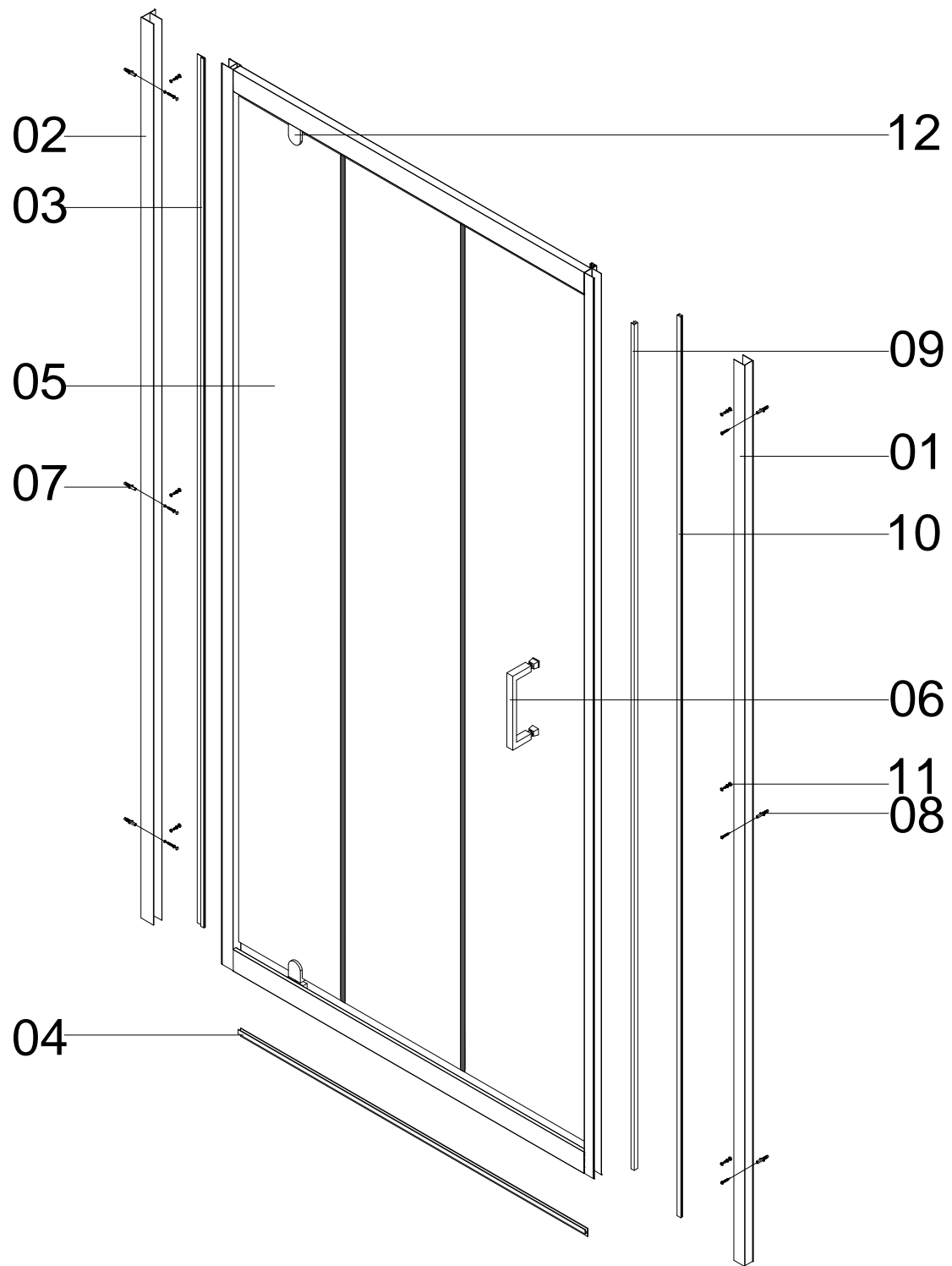

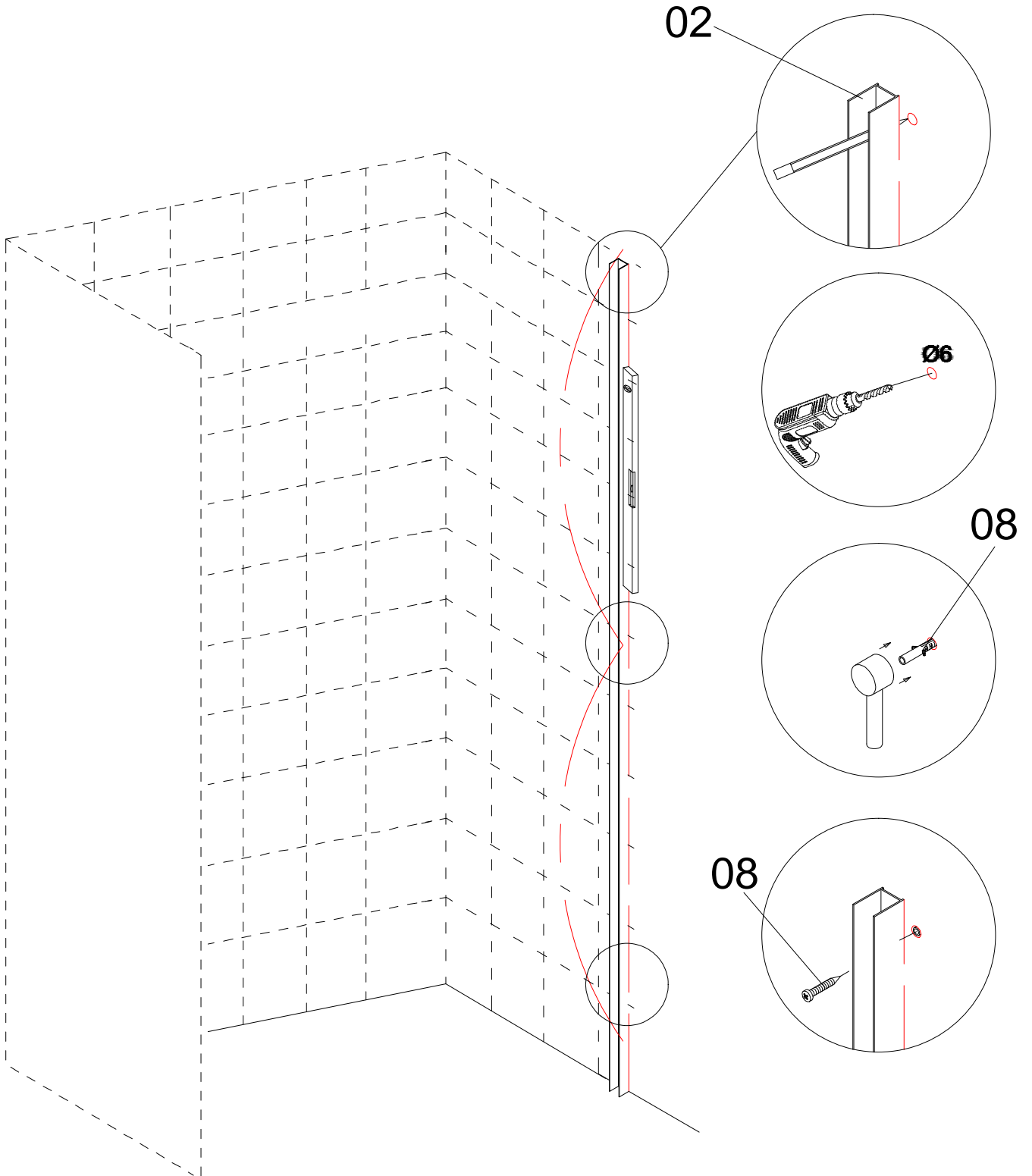
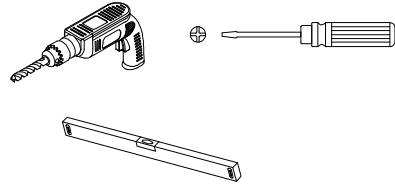
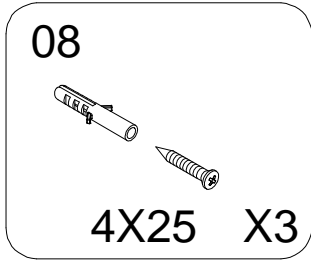
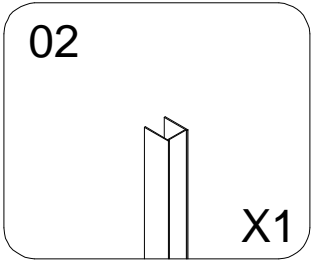

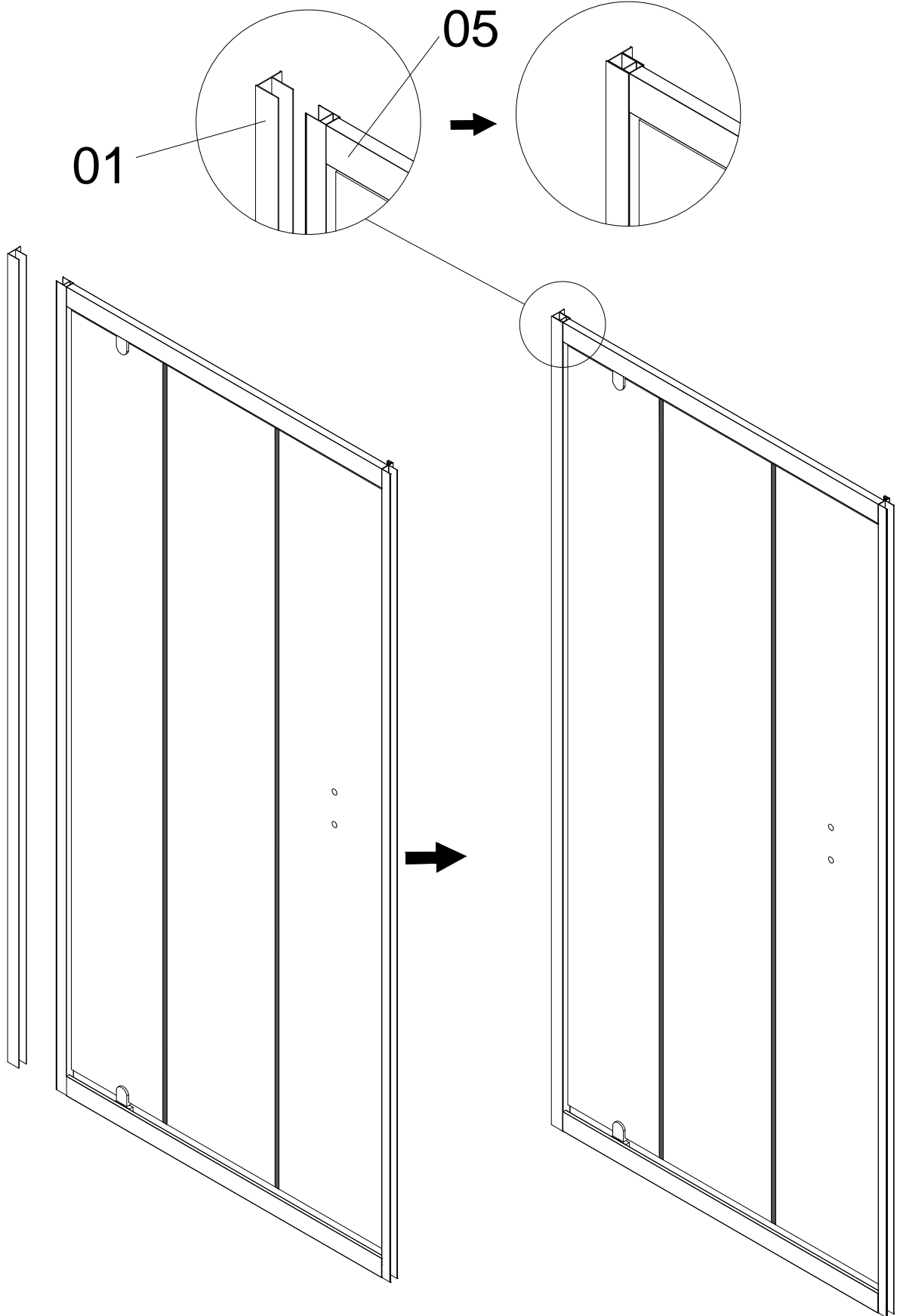
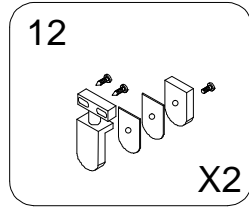
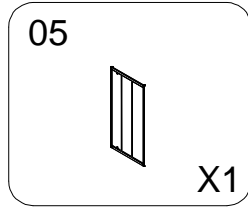
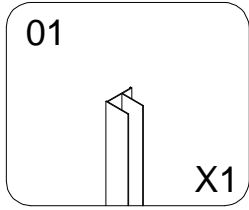

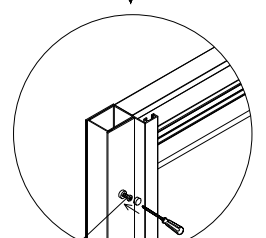
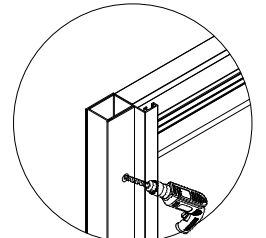
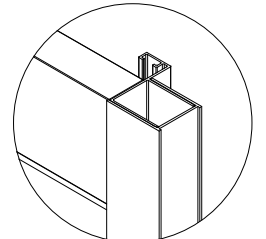
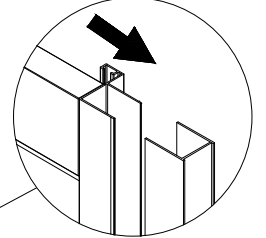
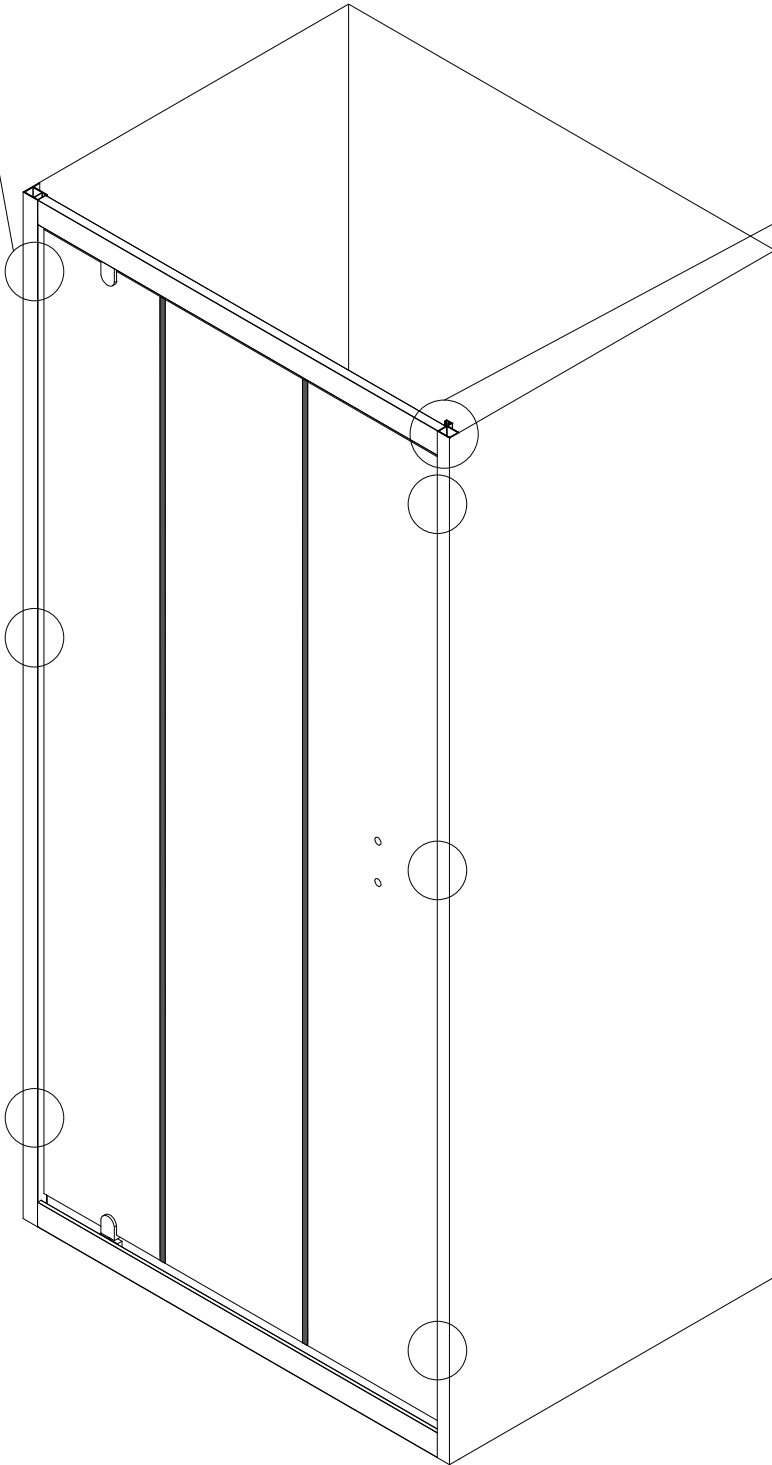
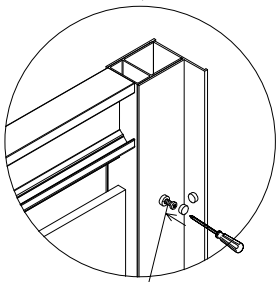
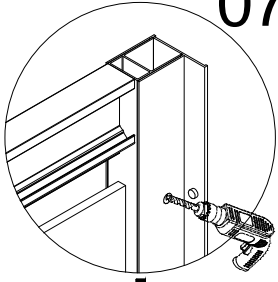
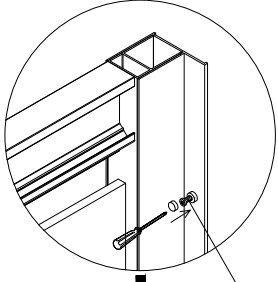
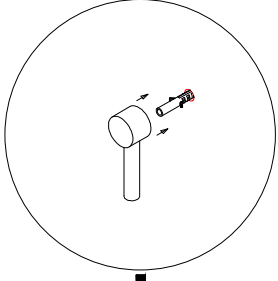
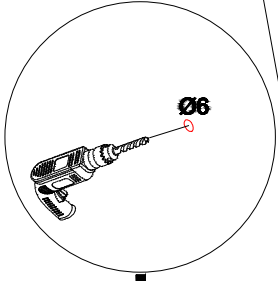
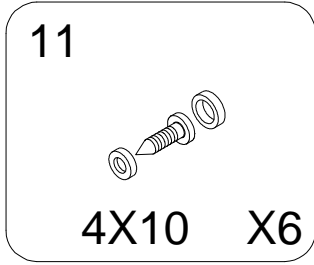
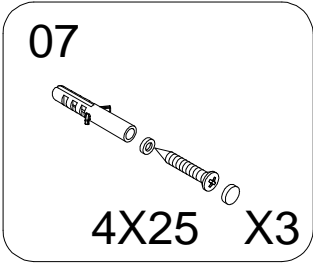
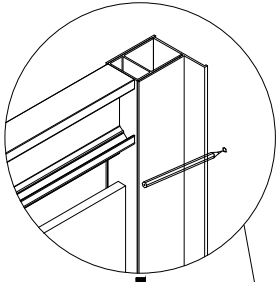

07

11

11

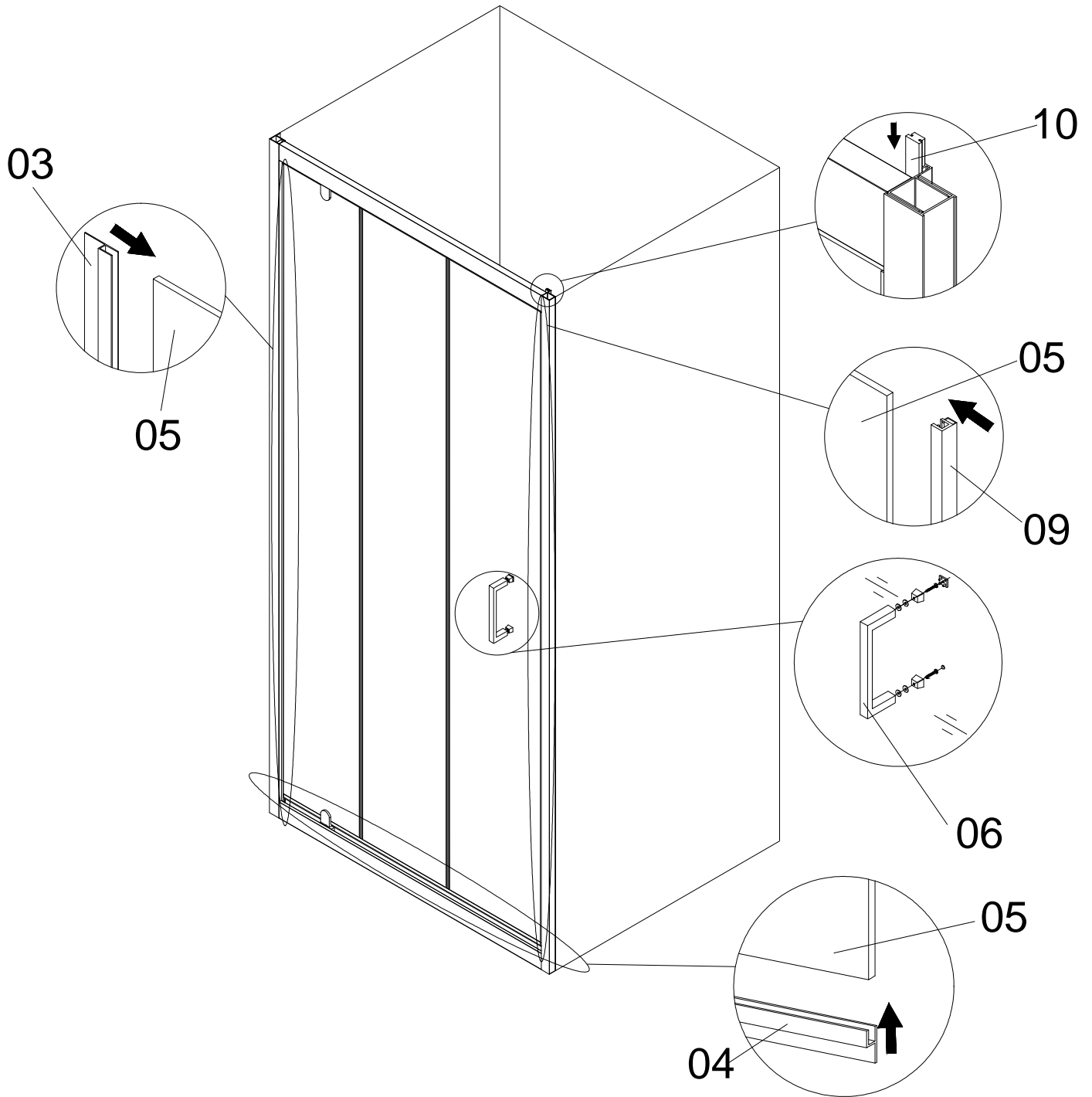
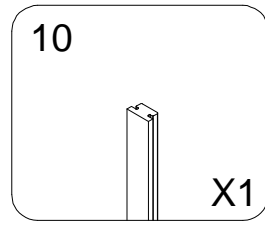
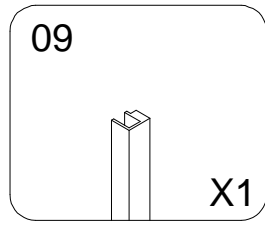
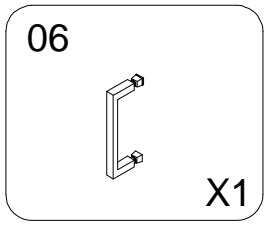
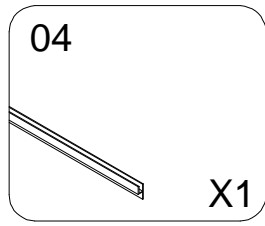
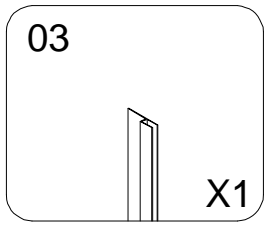

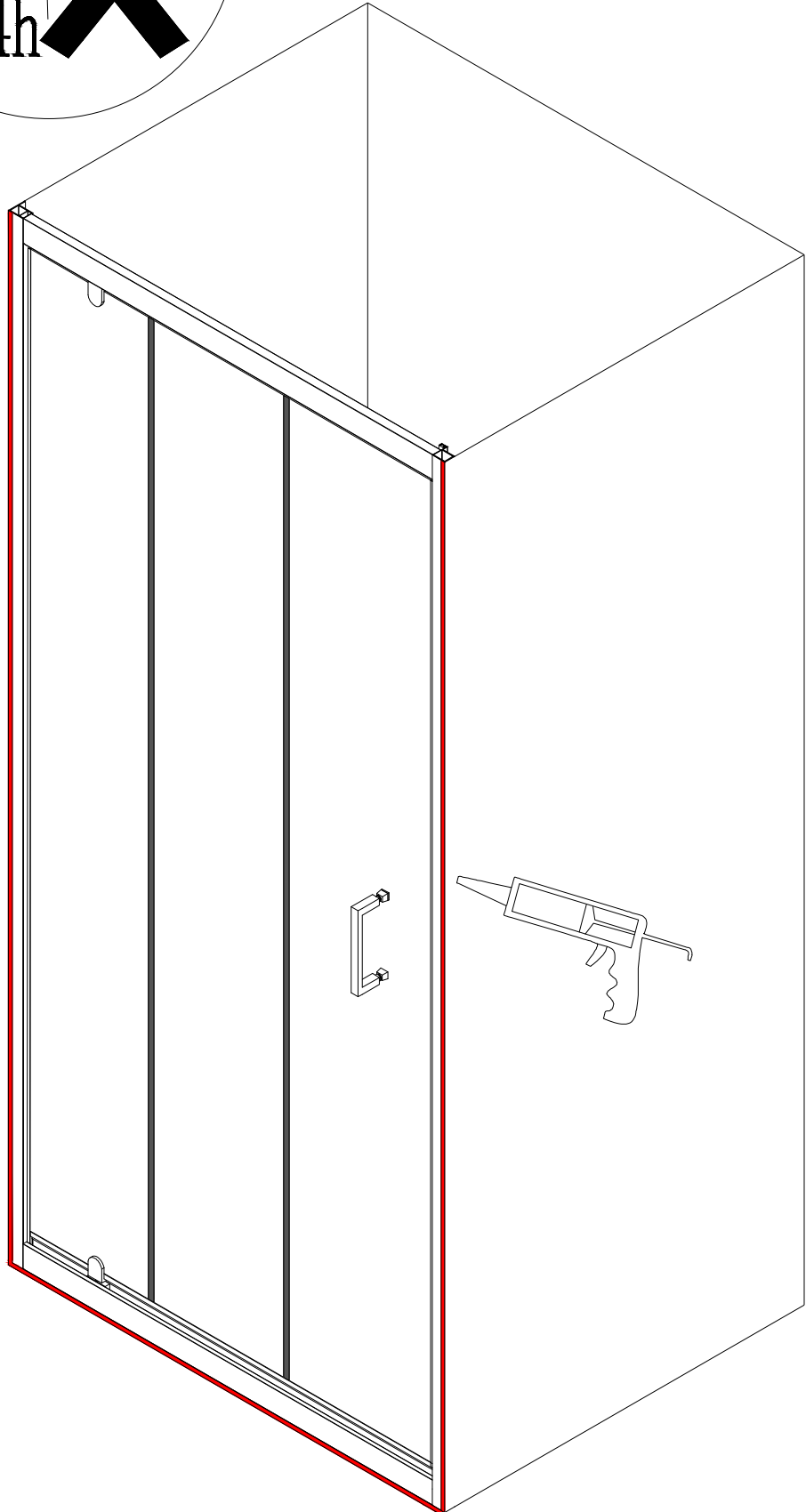

# DÉCLARATION DES PERFORMANCES

N o DoP\_FAC\_031

**1. Code d'identification du produit Type : FACTOR X**

Par extension, la présente déclaration des performances est applicable aux produits détaillés en annexe.

**2. Usage(s) prévu(s) :** ..... PAROIS DE DOUCHE POUR HYGIENE PERSONNEL-PH.....

**3. Fabricant :** .....AURLANE 32 rue Washington 75008 PARIS.....

**4. Mandataire :** .....Non applicable.....

**5. Système(s) d'évaluation et de vérification de la constance des performances:** système 4.....

**6a. Norme harmonisée:** EN14428:2004

Organisme(s) notifié(s) : Non applicable

**6b. Document d'évaluation européen** Non applicable

**Evaluation technique européenne** Non applicable

**Organisme d'évaluation technique** Non applicable

**Organisme(s) notifié(s)** Non applicable

**7. Performances déclarées**

Caractéristiques essentielles	Performances	Spécifications techniques harmonisées
Aptitude au nettoyage	Exigences satisfaites	EN14428:2004+A1:2008 Clause 4.2
Résistance à l'impact / Propriétés d'éclatement	Exigences satisfaites	EN14428:2004+A1:2008 Clause 4.3
Durabilité	Exigences satisfaites	EN14428:2004+A1:2008 Clause 4.4

Les performances du produit identifié ci-dessus sont conformes aux performances déclarées.

Conformément au règlement (UE) n°305/2011, la présente déclaration des performances est établie sous la seule responsabilité du fabricant mentionné ci-dessus.

**Signé au nom du fabricant par:**

Sébastien Doumenc  
Directeur associé Aurlane  
A paris, le 03/02/2020





ANNEXE 1 références

code_produit	Designation
FAC592	FACTORX 120 COULISSANTE
FAC593	FACTORX 140 COULISSANTE
FAC594	FACTORX 70 PIVOTANTE
FAC595	FACTORX 80 PIVOTANTE
FAC596	FACTORX 90 PIVOTANTE
FAC597	FACTORX RETOUR 80CM
FAC598	FACTORX RETOUR 90CM
FAC603	PARE BAIGNOIRE FACTORX 130X75

ANNEXE 2 marquage CE

