

# FAR TOOLS®



## DBH 1700D

Professional Machine

FR	Brise béton ( Notice originale )
EN	Demolition breaker hammer ( Original version translation )
DE	Abbruchhammer (Übersetzung aus dem Original-Anleitung)
ES	Martillo demoledor ( Traducción del manual de instrucciones originale )
IT	Martello demolitore ( Tradução do livro de instruções original )
PT	Martelo demolidor ( Traduzione dell'avvertenza originale)
NL	Sloophamer (Vertaling van de originele instructies)
EL	<b>Σφύρα κατεδάφισης (Μετάφραση από τις πρωτότυπες οδηγίες)</b>
PL	Młot rozbiórkowy (Tłumaczenie z oryginalnej instrukcji)
FI	Moska (Käännös alkuperäisestä ohjeet)
SV	udarno kladivo (Översättning från originalinstruktioner)
BG	Разрушителен чук (Превод на оригиналната инструкция)
DA	Nedrivningshammer (Oversættelse fra oprindelige brugsanvisning)
RO	Ciocan pentru demolat (Traducere din instrucțiunile originale)
RU	Отбойный молоток (Перевод с оригинальной инструкции)
TR	ELEKTROPNÖMATİK KIRICI (Orijinal talimatlar çeviri)
CS	Bourací kladivo (Překlad z originálního návodu)
SK	Búracie kladivo (Preklad z originálneho návodu)
HE	תורוקמ תוארהמ סוגרת) לברעמ
AR	قيلحصاا تامييعتلا نم قمجرتلا) قطالخ
HU	Bontókalapács (Fordítás az eredeti utasítások)
SL	udarno kladivo (Prevod iz izvornih navodil)
ET	Lõhkumisvasar (tõlge originaal juhiseid)
LV	Atskaldāmais āmurs (Tulkojumā no instrukcijas oriģinālvalodā)
LT	Ardomasis kūjis (vertimas iš originalių instrukcijas)
HR	Betonski povjetarac (Izvornu obavijest)



© FAR GROUP EUROPE

115369-5-I-20230411



fartools.com



5 min





Description et repérage des organes de la machine  
Description and location of machine parts

# A



Contenu du carton  
Contents of box

# B





Assemblage de la  
machine  
Assembly of the  
machine

C

## 01 IMPORTANT !

Remplir d'huile avant la première utilisation !  
Vul voor het eerste gebruik met olie!  
¡Llenar con aceite antes del primer uso!  
Encha com óleo antes do primeiro uso!  
Riempire con olio prima del primo utilizzo!  
Fill with oil before first use !





Assemblage de la machine  
Assembly of the machine

C



- \* en cas de non respect de cette consigne, la garantie ne s'applique pas en cas de dommage.
- \* Bij het niet naleven van deze instructie geldt de garantie bij schade niet.
- \* En caso de incumplimiento de estas instrucciones, la garantía no se aplica en caso de daños.
- \* No caso de não cumprimento desta instrução, a garantia não se aplica no caso de danos.
- \* No caso de não cumprimento desta instrução, a garantia não se aplica no caso de danos.
- \* if this instruction is not followed, the warranty does not apply in the event of damage.



Fonctionnalité de la machine  
Functions of the machine

D

01

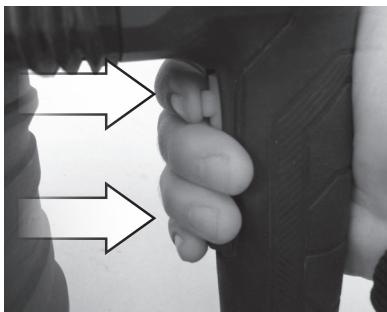
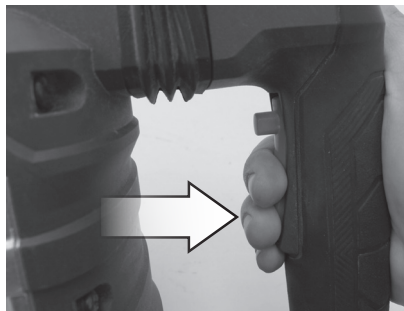
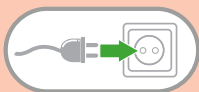



Fonctionnalité de la machine  
Functions of the machine

**D**

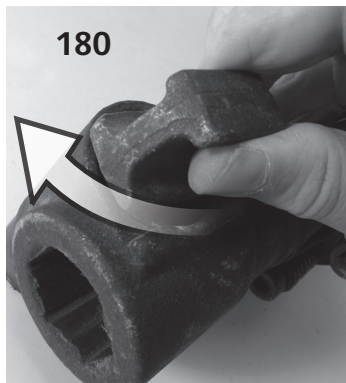
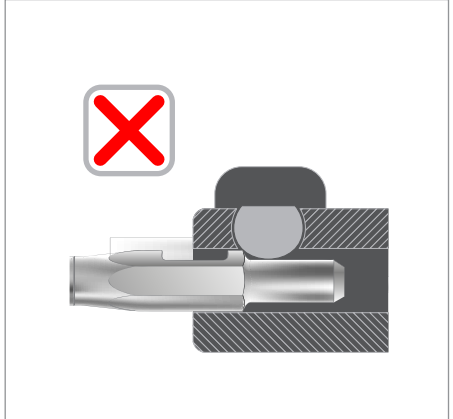
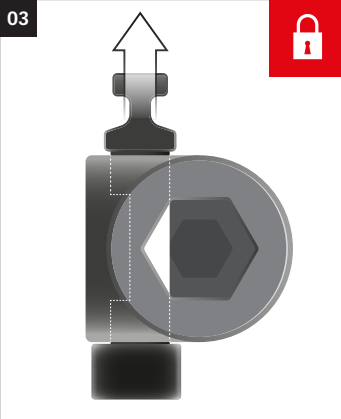
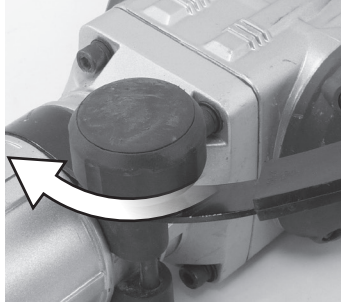
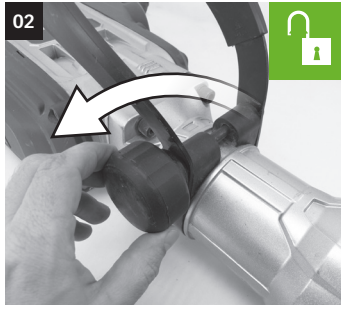



Fonctionnalité de la machine  
Functions of the machine

D

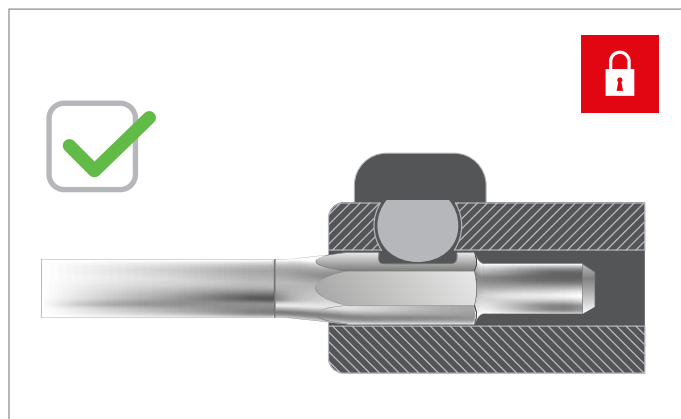
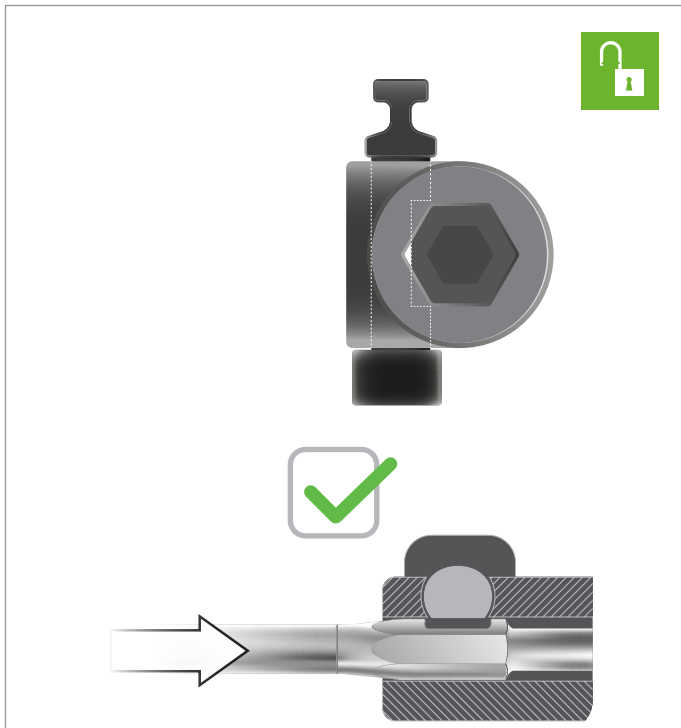
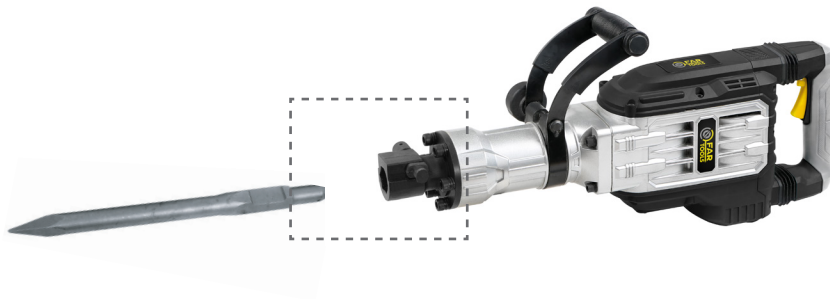



Réglages de la machine  
Machine settings

E

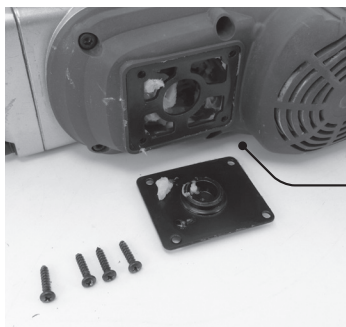
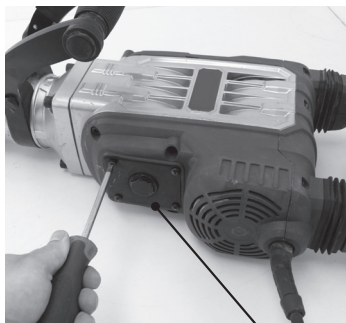

Tous les trois mois  
Elke drie maanden  
Cada tres meses  
A cada tres meses  
Ogni tre mesi  
Every three months



15W40



Dérippant / Lubrifiant  
Penetrerend / smeermiddel  
Penetrante / Lubrificante  
Penetrante / Lubrificante  
Penetrante / lubrificante  
Penetrating / Lubricant









	<p>Tension et fréquence assignée : Nominal frequency and power: Spannung und Frequenz: Tensión y frecuencia fijada: Tensione e frequenza assegnata: Tensão e frequência fixa: Aangegeven spanning en frequentie: <b>Ονομαστική τάση και συχνότητα:</b> Napięcie i częstotliwość przydzielona: Jännite ja määrittäty taajuus: Angiven spänning och frekvens: Anført spænding og frekvens: Tensiune și frecvență de lucru:</p>	<p>Заданное напряжение и частота: Tahsis gerilimi ve frekansı: Stanovené napětí a frekvence: Stanovené napätie a frekvencia: מתח ומדר מוקצב الغلطية والذبذبة المبرمجة. Névfleges feszültség és frekvencia: Napetost in določena frekvenca: Консумирано напрежение и честота : Määratud pinge ja sagedus Nustatyta įtampa ir dažnis Noteiktāis spriegums un frekvence. Napon i nazivna frekvencija:</p>	230 V ~ 50 HZ
--	--	--	---------------

	<p>Puissance assignée : Nominal power: Leerlaufdrehzahl: Potencia fijada: Potenza assegnata: Potência assinada: Onbelast toerental: <b>Ονομαστική ισχύς:</b> Prędkość na biegu jałowym: Teho: Angiven effekt: Anført styrke: Putere de lucru:</p>	<p>Заданная мощность: Tahsis edilen güç: Stanovený příkon: Predpísaný výkon: כוח מוקצב. القدرة المبرمجة. Névfleges teljesítmény : Določena jakost: Консумирана мощност: Määratud võimsus. Nustatyta galia Noteiktā jauda Nazivna snaga:</p>	1700 W
--	---	---	--------

	<p>Vitesse à vide : No-load speed: Drehzahl unbelastet: Velocidad vacía: Velocità a vuoto: Velocidade no vácuo: Leerlaufdrehzahl: <b>Ταχύτητα αδράνειας:</b> Prędkość bezciążenia: Tyhjäkäyntinopeus Tomgånghastighet: Hastighed i ubelastet tilstand: Viteza în gol:</p>	<p>Скорость вращения на холостом ходу: Boşalma hızı: Rychlost naprázdno: Rýchlosť pri chode naprázdno: מהירות ריק. السرعة على الفارغ. Üres sebesség: Prosti tek: Скорост на празни обороти: Kiirus tühikäigul Tuščio prietaiso greitis Tukšgaitas ātrums Brzina praznog hoda:</p>	1900 Hit. min <sup>-1</sup>
--	---	---	-----------------------------





	<p>Classe d'isolement : 2 Insulation class : 2 Isolierung Klasse : 2 Aislamiento clase :2 Isolamento classe :2 Isolamento classe :2 Isolatie Klasse : 2 <b>Κατηγορία μόνωσης: 2</b> Izolacja Klasy :2 Eristysluokka :2 Isolering Klass :2 Isoleringsklasse 2 Clasă izolație :2</p>	<p>Класс изоляции 2 : Yalıtım derecesi :2 Třída izolace :2 Izolačný systém 2 סוג בידוד 2. فئة العزل 2. Szigetelési osztály :2 Razred izolacije :2 Инструмент Клас :2 Isolatsiooniklass 2 Izolācijas rūšis 2 Izolācijas klase 2 Izolacija klasa: 2</p>	X
--	--	---	---



	<p>Lire les instructions avant usage :          Read the instructions before use :          Vor Einsatz des Geräts Anweisung lesen :          Léase las instrucciones antes de usar :          Leggere le istruzioni prima dell'uso :          Ler as instruções antes da utilização :          Lees voor het gebruik de instructies :  <b>Διαβάστε τις οδηγίες πριν από τη χρήση:</b>          Zapoznać się instrukcją przed użyciem :          Lue ohjeet ennen käyttöä :          Läs anvisningarna före användning :          læs instruktionerne før brug          Înainte de utilizare, cititi instructiunile :</p>	<p>Внимательно прочитайте следующие инструкции :          Kullanmadan talimatları okuyunuz :  <b>Pozorně si přečtete následující pokyny :</b>  <b>Pred použitím si prečítajte pokyny :</b>          דרום חילופי          اقرأ التعليمات قبل الاستخدام.  <b>használat előtt olvassuk el az utasítást :</b>  <b>Pred uporabo preberite ustrezna navodila :</b>          Прочетете указанията за употреба :          Enne kasutamist lugege instruksiooni          Prieš naudojimą perskaityti instrukciją          izlasīt instrukcijas pirms lietošanas          Pročitati upute prije uporabe:</p>	X
	<p>Conformité européenne :          Conforms to EC standards :          CE-Konformität :          Cumples con las directivas CE :          Conforme alle norme CE :          Conforme às normas CE :          Voldoet aan de EG-normen :  <b>Ευρωπαϊκή Συμμόρφωση:</b>          Zgodność z normami CE :          EU-standardien mukainen :          EU-standardien mukainen :          Overholder EU standarderne :          Conform cu normele europene:</p>	<p>соответствие европейским стандартам:          Avrupa uygunluk :  <b>Evropská shoda :</b>  <b>Európska dohoda :</b>          התאמה לתקני האירופיים          مطابقت للجواصفات الأوروبية.  <b>Evropska ustreznost :</b>  <b>Európai megfeleléség :</b>          Съответствие с европейските норми :          Euroopa Liidu vastavusmärk          Europinių normų atitikima          Atbilstība Eiropas standartiem  <b>Europska sukladnost</b></p>	X
	<p>Poids :          Weight :          Gewicht :          Peso :          Peso :          Peso :          Gewicht :  <b>Βάρος :</b>          Masa :          Paino :          Vikt :          Vægt :          Greutate :</p>	<p>Бес :          Ağrlık :          Hmotnost :          Hmotnost :          משקל          الوزن.          Súly :          Teža :          Тегло :          Raskus          Svoris          Svarts          Težina:</p>	13 kg





  	<p>Porter des lunettes de sécurité : Porter un masque anti-poussière: Porter une protection auditive: Wear protective eyewear : Wear a dust mask : Wear hearing protective equipment: Schutzbrille tragen : Staubschutzmaske tragen : Gehörschutz tragen: Llevar puestas gafas protectoras : Llevar puesta una careta de protección contra el polvo : Llevar puesta una protección auditiva: Portare de gli occhiali di sicurezza : Indossare una mascherina anti-polvere : Portare una protezione uditiva: Utilizar óculos de segurança : Utilizar uma máscara anti-poeira : Utilizar uma protecção auditiva: Draag een veiligheidsbril : Draag een stofmasker : Draag gehoorbeschermers: <b>Φοράτε προστατευτικά γυαλιά: Φορέστε μάσκα για τη σκόνη: Φοράτε προστασία ακοής:</b> Zakładać okulary ochronne : Zakładać maskę przeciwpyłową Zakładać słuchawki ochronne Käytä suojalaseja : Käytä pölysuojust : Käytä kuulosuojaimia: Använd skyddsglasögon : Bär mask mot damm : Bär hörselskydd: Der skal benyttes sikkerhedsbriller : Der skal benyttes beskyttelsesmaske mod støv: Der skal benyttes hørevern: Purtatı ochelari de protecție : Purtatı mască anti-praf : Purtatı căști de protecție auz:</p>	<p>Наденьте защитные очки : Наденьте респиратор : наденьте средства звуковой защиты: Güvenlik gözlükleri takın : Toza karşı maske takın : İşitsel koruma aleti takın: Používejte bezpečnostní brýle : Používejte masku proti prachu : Používejte ochranu sluchu: Noste ochranné okuliare : Noste ochrannú masku proti prachu : Noste ochranné slúchadlá: תחובי יקשמ ביכרהל אנ קבא דגנ הכסמ שובחל אנ יש ל הרכיב הגנת שמיעה چمک نظارات وقایة. لبس قناع مضارخ للذغبار. لبس خوذة ضرس الضحیح. Viseljen védőszemüveget : Viseljen porvédő maszkot Viseljen fülvédőt Nositi zaščitna očala : Nositi zaščitno masko proti prahu: Nositi zašito ušes: Да се използват защитни очила : Да се използва защитна маска : Да се използва слухови защитни средства: Kandke kaitseprille Kandke tolumumaski. Kandke kõrvakaitset Nešioti apsauginius akinius Dėvėti respiratorių Nešioti apsaugą nuo triukšmo Valkät aizsargbrilles Valkät aizsarg masku pret puteļņiem valkät dzirdes aizsarglīdzekli Nositi zaštitne naočale: Nositi masku za zaštitu od prašine: Nositi štitnike protiv buke:</p>	X
	<p>Porter des gants : Use rubber gloves : Scchutzhandschuhe tragen : Llevar guantes de protección : Indossare i guanti di protezione : Utilizar luvas de protecção : Draag veiligheidshandschoenen : <b>Φορώντας γάντια:</b> Używać rękawic ochronnych : Käytä suojakäsineitä : Använd skyddshandskar : Der skal benyttes handsker : Purtatı mənüşü :</p>	<p>Наденьте перчатки : Eldiven takın : Noste rukavice : Noste rukavice : توففك شوبلل ان لبس قفازات. Viseljen kesztyű t Nositi rokavice: а се използват предпазни ръкавици : Kandke kindaid Müvēti pirštines Valkät cimdus Nositi zaštitne rukavice:</p>	X



	<p>Soumis à recyclage Subjected to recycling Sujeto a reciclaje Sottoposti a riciclaggio Sujeitos a reciclagem Não deite no lixo Niet wegwerpen Υπόκειται σε ανακύκλωση Nie wyrzucac Älä heitä pois luontoon Batteriet får inte kastas Bortkast det ikke Nu le auncati</p>	<p>Подлежит переработке Atmayiniz Nevyhazujte je do bežného odpadu Neodhadzovat Gjenvinningspliktig قللا ترحمها هلندا فسي القمامة. ne mečíte1 Ne odvržite ga/jih vstran Taaskasutusse kuuluv Ärge visake seda minema Nemetykite Nemest Podvrgnuto recikliranju</p>	×
---	--	--	---

**Recyclage des déchets :**

Les outils, accessoires et leur emballages doivent suivre une voie de recyclage adaptée. Conformément aux directives Européenne 2012/19/UE et 2006/66/CE, les composants d'un produit doivent être séparés, collectés, recyclés ou éliminés en conformité avec les réglementations environnementales en vigueur. Les appareils, batteries, piles, huiles, emballages devront être déposés dans les systèmes d'élimination des déchets spéciaux tels que déchetteries. Renseignez-vous auprès de votre commune pour connaître l'organisme le plus proche à même de retraiter ou de collecter ces déchets.

	<p>Recyclable, soumis au tri sélectif Recyclable, subject to recycling Recyclingfähige, unterliegen Recycling Recyclables, sujetos a reciclaje Riciclabili, soggetti a riciclaggio Recicláveis, sujeito à reciclagem Recycleerbare, onderworpen aan recycling Ανακυκλώσιμο, υπόκειται σε επιλεκτική διαλογή Opakowanie nadaje się do recyklingu podlegają recyklingu Kierrätettävien pakkausten kohteena kierrätys Återvinningsbara förpackningar omfattas återvinning Рециклираци се опаковки подлежат на рециклиране Genanvendelig underlagt genbrug</p>	<p>Reciclabile sub rezerva reciclare Повторно упаковка подлежит вторичной переработке Geri dönüştürme Geri dönüştürülebilir ambalaj konusu Recyklovateľné podléhající recyklaci Recyklovateľné podliehajúce recyklácii Resirkulerbar, med förbehold om selektiv sortering ريودنلا خا اعال يرضخت ريودنلا خا اعال تاباؤلا فيلرخللو خويب خنلا Újrahasznosítható csomagolás alá újrahasznosítás Reciklirati predmet recikliranja Pakendite suhtes ringlussevõtu Pärsträdajams iepakojuoms otrreizējai pārstrādei Perdirbamų taikomos perdirbimo Može se reciklirati, podložno selektivnom sortiranju</p>	×
---	--	--	---





 <b>L<sub>pA</sub></b>	Niveau de pression acoustique :	Уровень акустического давления. :	84,02 dB (A)
	Acoustic pressure level :	Akustik basınç seviyesi :	
	Schalldruckpegel :	Hladina akustického tlaku :	
	Nível de presión acústica :	Hladina akustického tlaku :	
	Livello di pressione acustica :	רמת לחץ אקוסטי.	
	Nível de pressão acústica :	مستوى الضغط السمعي.	
	Niveau akoestische druk :	A hangnyomás szintje :	
	<b>Στάθμη ηχητικής πίεσης:</b>	Nivo akustičnega pritiska:	
	Poziom mocy akustycznej :	Равнище на акустично налягане :	
	Käytä kuulosuojaimia :	Helirõhu nivoo	
	Ljudtryksnivå :	Akustinio spaudimo lygis	
	Lydtryk :	Akustiskā spiediena līmenis	
	Nível presiune acustică :	Razina zvučnog tlaka:	

 <b>L<sub>WA</sub></b>	Niveau de puissance acoustique :	уровень мощности звука :	104,02 dB (A)
	Acoustic power level :	Akustik basınç seviyesi :	
	Schalleistungspegel :	Hladina zvukového výkonu :	
	Nível de potencia acústica :	Hladina zvukového výkonu :	
	Livello di potenza acustica :	רמת כוח אקוסטי.	
	Nível de potência acústica :	مستوى الصوتي.	
	Niveau akoestisch vermogen :	a hangnyomás szintje :	
	<b>Επίπεδο ισχύος ήχου:</b>	Nivo akustične jakosti :	
	Poziom mocy akustycznej :	Равнище на вибрации :	
	Käytä suojalaseja :	Helivõimsuse nivoo	
	Ljudstyrkenivå :	Triukšmo lygis	
	Lydstyrke :	Akustiskās jaudas līmenis	
	Nível putere acustică :	Razina zvučne snage:	

NIVEAU SONORE D'ÉMISSION :

A VIDE

Pression acoustique L<sub>pA</sub> poste opérateur  
Incertitude

84,02 dB  
3

Puissance acoustique L<sub>WA</sub>  
Incertitude

104,02 dB  
3

Valeurs déterminées suivant le code d'essai de l'annexe B de la norme EN 61029-1 avec emploi des normes de base ISO 11201 et ISO 3744.

Les niveaux de pression acoustique obtenus in situ dépendent :

- Des niveaux réels de la machine considérées, en prenant en compte les incertitudes déclarées;
  - Du local et de l'installation de la machine. Préférez une pièce dont l'acoustique est plus feutrée.
- Évitez les pièces vide à grande résonance. Placez vous auprès d'une fenêtre le cas échéant.
- Des outils montés, des pièces travaillées, des réglages choisis,...

 <b>L<sub>WA</sub></b>	Niveau de vibration :	Уровень вибрации :	17,87 m / s <sup>2</sup>
	Hand/arm vibration level :	Titreşim seviyesi :	
	Vibrationspegel Hand/Arm :	Úroveň vibrací :	
	Nível de vibración mano/brazo :	Hladina vibrácií :	
	Livello di vibrazione mano/braccio :	רמת תנודות	
	Nível de vibração mão/braço :	مستوى الارتجاج.	
	Trillingsniveau hand/arm :	Vibrációsínt :	
	<b>Επίπεδο κραδασμών:</b>	Nivo vibracij :	
	Poziom wibracji rżka/ramię :	Равнище :	
	Tärinätaso:	Vibrācijas līmenis.	
	Vibrationsnivå hand/arm :	Vibracijos lygis	
	Vibrations niveau :	Vibratsioonini nivo	
	Nível vibrații :	Razina vibracije:	

VIBRATIONS:

Total des valeurs de vibration (somme vectorielle des trois directions) déterminée selon EN 60745 :

a 17,87 m/s<sup>2</sup>  
Incertitude K 1,5 m/s<sup>2</sup>

L'amplitude d'oscillation peut être utilisée comme valeur de comparaison d'outils électroportatifs.

Attention : si l'outil électroportatif est utilisé pour d'autres applications, avec d'autres outils de travail, l'amplitude d'oscillation peut être différente.





DBH 1700D

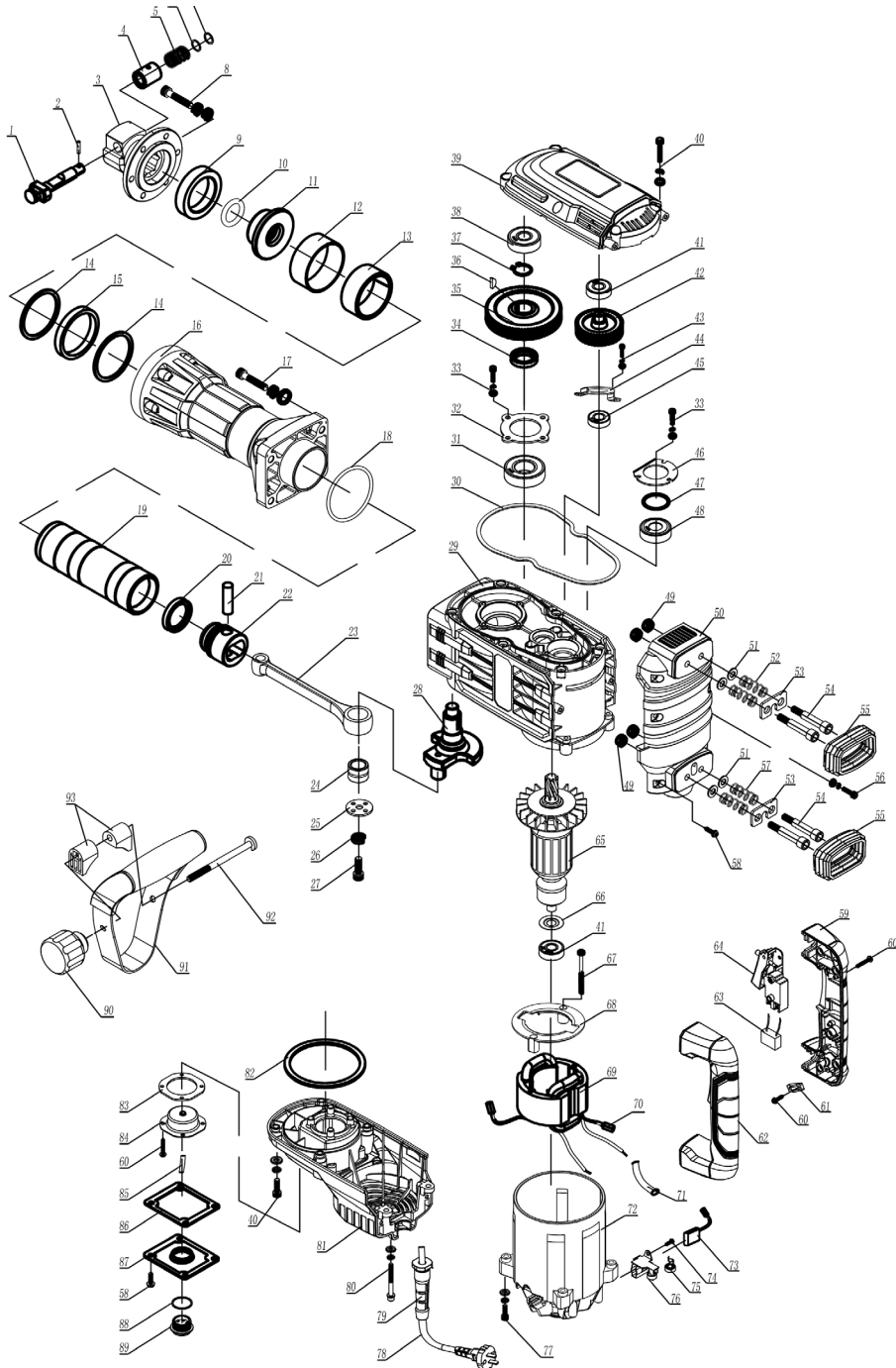



DECLARATION DE CONFORMITE  
VERKLARING VAN OVEREENSTEMMING  
DECLARACION DE CONFORMIDAD  
DICHIARAZIONE DI CONFORMITA  
KONFORMITÄSERKLÄRUNG  
DECLARATION CONFORMITY  
DECLARAÇÃO DE CONFORMIDADE  
DEKLARACJA ZGODNOSCI Z NORMAMI  
OM ÖVERENSSTÄMMELSE  
VAATIMUSTENMUKAISUUSVAKUUTUS  
ÖVERENSSTEMMELSESERKLÆRING  
ΔΗΛΩΣΗ ΣΥΜΜΟΡΦΩΣΗΣ

DECLARAȚIE DE CONFORMITATE  
VYHLÁSENIE ZHODY  
Декларация соответствия  
**SAMSVARERKLÆRING**  
Uygünlük beyanı  
الاصدريج بالمطابق ة  
PROHLÁŠENÍ SHODY  
EGYZŐSÉGI NYILATKOZAT  
Декларация за съответствие с нормите  
IZJAVA O SKLADNOSTI  
DEKLARACIJA  
ATTITIKTES DEKLARACIJA  
KINNITUS  
IZJAVA O SKLADNOSTI

Le soussigné,  
Ondergetekende,  
Der Unterzeichner,  
O abaixo assinado,  
Undertecknad,  
Долуподписаният  
Undertegnede  
Subseminatul,  
Я, нижеподписавшийся,  
Imzalayan,  
Niže podepsany,  
Toliau pasirašęs

Personne autorisée à constituer  
le dossier technique :  
Christophe HUREL



FAR GROUP EUROPE  
192, Avenue Yves Farge  
37700 St. Pierre-des-Corps  
FRANCE

El suscrito,  
Il sottoscritto,  
The undersigned,  
Níneí podpísany  
Allékirjoittanut,  
Ο κάτωθι υπογεγραμμένος,  
Nižsie podpisany  
Undertegnede,  
الاصدريج بالاصدريج  
Alulírott,  
Podpisani,  
Apakšá parakstijies  
allakirjutanu  
Dolje potpisani,

Declara por la presente que,  
Dichiare che,  
Declares that,  
Oświadczam niniejszym, że  
Ilmoitetaan täten että,  
**Δια του παρόντος δηλώνει ότι,**  
tymto vyhlasuje, že  
يصرح اسجنانا على ذلك  
Pareiskia, kad,  
Ar šo apliecinu, ka,  
Kinnitab, et  
izjavljuje u ovom dokumentu da je

Déclare par la présente que,  
Verklaart hiermede dat,  
Erklärt hiermit daß,  
Declara pela presente que,  
Förklarar härmed att  
Заявляю с настоящюто  
erklærer hermed, at  
Declara prin prezenta că,  
настоящим подтверждаю, что  
Mevcut belgeyle beyan ediliyor ki,  
tımto prohlasuje, že,  
Pareiskia, kad,

demolition breaker Hammer / Marteau démolisseur / Abbruchhammer / Martillo demohedor / Martello demolitore / Martelo demolidor / Sloopamer / Σπύρα  
κατεδάφισης / Młot rozbiórkowy / Moska / Udarno kladivo / Разрушительный чук / Nedrivningshammer / Отбойный молоток / Darbeli çekici / Bouracé kladivo / Búracé  
kladivo / מכרעם / Bontókalapács / udarno kladivo / Löhkumisvasar / Ardomasís Kújis / Atskaldámais ámuris

## code

FARTOOLS / 115369 / DBH 1700D / Z1G-DS-107M

**Est conforme et satisfait aux directives et normes CE,**  
In overeenstemming is met en Voldoet aan EG richtlijnen,  
Den folgenden EU-Bestimmungen entspricht,  
Respeita e está em conformidade com as normas CE,  
Överensstämmer med och uppfyller EG-standarder,  
Съответства и отговаря европейските норми  
Er i overensstemmelse med og overholder EU standarderne  
Este conform și satisface normele CE  
полностью соответствует и удовлетворяет  
требованиям стандартов ЕС  
CE şartlara uygundur,  
odpovídá normám ES.  
Atitinka ir atitinka EB direktyvas ir standartus,

Cumple con la directivas de la CE,  
E conforme alle direttive CEE,  
Complies with the EEC directives and standards,  
Odpowiada normom UE,  
Täyttää EU-vaatimukset,  
Συμμορφώνεται και ικανοποιεί τις οδηγίες και τα πρότυπα CE,  
zodpovedá normám ES.  
Samsvarer med og tilfredsstiller CE-direktiver og standarder,  
بان الاجاز يطاق و يلى م اى يدر م جود ة الدول الاوربية  
kielegiti a CE szabványok előírásait.  
Je v skladu z in izpolnjuje norme Evropske skupnosti.  
Atbilst un atbilst EK direktivas un standartus,  
Vastab ja vastab EU direktiividele ja standartitele,  
Sukladan i ispunjava direktive i standarde CE,

2006/42/EC 2014/30/EU 2011/65/EU 2015/863/EU

EN 62841-1:2015+A11:2022  
EN IEC 62841-2-6:2020+A11:2020  
EN IEC 55014-1:2021  
EN IEC 55014-2:2021  
EN IEC 61000-3-2:2019+A1:2021  
EN IEC 61000-3-11:2019

Christophe HUREL,  
Président Directeur Général  
18/07/2023  
Fait à St. Pierre-des-Corps



**DBH 1700D**  
115369

230V-50Hz    1700 W    1900 U/min\*    13 Kg

60 J

Made for FAR GROUP EUROPE - 192 Avenue Yves Farge - Saint Pierre (37700) - FRANCE  
Z1G-DS-107M  
Serial number / numéro série :

FAR  
TOOLS®

DBH 1700D                      115369

IMPORTANT ! BELANGRIJK! IMPORTANTE! IMPORTANTE! ¡IMPORTANTE! IMPORTANT!

\* Remplir d'huile avant la première utilisation !  
Vul voor het eerste gebruik met olie!  
¡Llenar con aceite antes del primer uso!  
Encha com óleo antes do primeiro uso!  
Riempire con olio prima del primo utilizzo!  
Fill with oil before first use !

\* en cas de non respect de cette consigne, la garantie ne s'applique pas en cas de dommage.  
\* In het geval van niet naleven van deze instructie kan de garantie niet worden toegepast.  
\* En caso de incumplimiento de estas instrucciones, la garantía no se aplica en caso de daños.  
\* No caso de não cumprimento destas instruções, a garantia não se aplica no caso de danos.  
\* In caso de non adempimento della istruzione, la garanzia non si applica nel caso di danni.  
\* If this instruction is not followed, the warranty does not apply in the event of damage.

Voir manuel page 2-1  
See user manual page 2-1

115369-5-Oil sticker-B-03.indd 1

01/07/2021 09:29

IMPORTANT !

REMPLEZ D'HUILE AVANT LA PREMIÈRE UTILISATION !

REMPLEZ D'HUILE AVANT LA PREMIÈRE UTILISATION !  
FILL WITH OIL BEFORE FIRST USE !

115369-5-Oil sticker-A-04.indd 1                      30/06/2021 10:30



## GARANTIE - WARRANTY



### FR. GARANTIE

Cet outil est garanti contractuellement contre tout vice de construction et de matière, à compter de la date de vente à l'utilisateur et sur simple présentation du ticket de caisse. La garantie consiste à remplacer les parties défectueuses. Cette garantie n'est pas applicable en cas d'exploitation non conforme aux normes de l'appareil, ni en cas de dommages causés par des interventions non autorisées ou par négligence de la part de l'acheteur. La garantie ne s'applique pas sur les dommages causés par une défaillance de l'outil.

### DE. GARANTIE

Die Garantiezeit für dieses Gerät in Bezug auf Konstruktions- und Materialfehler beträgt lt. Vertrag bei Vorlage des Kassensbons. Die Garantieleistung besteht im Ersatz schadhafter Teile. Die Garantie erlischt bei einem Einsatz des Geräts, der nicht normentsprechend ist, bei Schäden, die auf unsachgemäße Eingriffe zurückzuführen sind bzw. bei Nachlässigkeit seitens des Käufers. Die Garantie erstreckt sich nicht auf Schäden, die auf Fehlfunktionen des Geräts zurückzuführen sind.

### IT. GARANZIA

Quest' attrezzo è garantito per contratto contro qualsiasi difetto di costruzione e di materia, a partire dalla data di vendita all'utente e su semplice presentazione dello scontrino. La garanzia consiste nel sostituire le parti difettose. Questa garanzia non è applicabile in caso di struttamento non conforme alle norme dell'apparecchio, né in caso di danni causati da interventi non autorizzati o da negligenza da parte dell'acquirente. La garanzia non si applica ai danni causati da un'avaria dell'attrezzo.

### EN. GARANTEE

This tool is guaranteed, in writing, against any defect in manufacture or parts from the date of sale, upon simple presentation of the sales slip. The guarantee is limited to the replacement of faulty parts. This guarantee is not applicable in the event of usage which is not conform with the intended usage of the apparatus, nor in the event of damage caused by unauthorised servicing or negligence on behalf of the purchaser. This guarantee does not apply to any damage caused by the failure of this tool.

### ES. GARANTIA

Esta herramienta se garantiza contractualmente contra todo defecto de construcción y materia, a partir

de la fecha de venta a l' usuario y sobre simple presentación del recibo de caja. La garantía consiste en sustituir a las partes defectuosas. Esta garantía no es aplicable en caso de explotación no conforme a las normas del aparato, ni en caso de daños causados por intervenciones no autorizadas o por negligencia por parte del comprador. La garantía no se aplica sobre los daños causados por un fallo del herramienta.

### NL. GARANTIE

Dit gereedschap heeft een garantie tegen constructeurfouten en materiaaldefecten, die geldig is vanaf de aankoopdatum door de gebruiker, op vertoning van de kassabon. De garantie betreft de vervanging van de defecte onderdelen. Deze garantie is niet van toepassing indien het apparaat niet volgens de normen gebruikt is, noch in geval van schade veroorzaakt door onjuist gebruik of nalatigheid van de koper. De garantie is niet van toepassing op schade voortvloeiend uit een defect van het gereedschap.

### PT. GARANTIA

Esta ferramenta tem uma garantia contratual contra qualquer defeito de construção e de material, a partir da data de venda ao utilizador e sobre simples apresentação do talão da caixa. A garantia consiste em substituir as partes defeituosas. Esta garantia não é aplicável no caso de exploração não conforme as normas do aparelho, nem em caso de danos causados pelas intervenções não autorizadas ou por negligência da parte do comprador. A garantia não se aplica para os danos causados por uma falha da ferramenta.

To ergale9io avt9o f9ere  
symbatik9h egg9yhsz gia  
oPoiod9hPote el9attvma  
kataskeyhz aP9o thn  
hmeromhyia p9vlihozh sto  
x9hstih me aP19h Prosk9omish  
thz aP9o-oeihz agor9az. H  
egg9yhsz aPotele9itai att9o  
thn antikata9oatoh tvn  
elattvmatik9vn tmhm9atvn.  
H Paro9yssa. egg9yhsz oen  
ewarm9ozetai se Per9iPvsh  
x9hshz mh szymvwnhz me  
ta Pr9otyPa thz syskem9hz.  
h se Per9iPtvszh zhmi9az.  
Poy Prok19hUkhe aP9o mh  
egkekrim9enn eP9embash  
9h aP9o am9eleia toy  
agorast9h. H egg9yhsz Ooen  
ewarm9ozetai se zhmi9ez Poy  
Prokalo9yntai aP9o bl9abh toy  
ergale9ioy. Stavro9i keno9y  
Diasthmo2Par9embysma

### PL. GWARANCJA

Narz dzie jest obite gwarancja na wszelkie wady konstrukcyjne i materiałowe, licząc od daty sprzedaży uytownikowi i po okazaniu paragonu kasowego. Gwarancja obejmuje wymianę cz-aci wybrakowanych. Gwarancja nie

znajduje zastosowania w przypadku uytkowania niezgodnego z normami urzadzenia, ani w przypadku szkod spowodowanych zaniedbaniami ze strony nabywcy. Gwarancja nie obejmuje szkod powstajlch z powodu upadku urzadzenia.

### SV. GARANTI

Detta verktyg har en avtalsenlig garanti mot konstruktions- och materialfel, från och med tidpunkten för användarens inköp och genom uppvisning av kassakvittot. Garantin består i att ersätta de bristfälliga delarna. Denna garanti gäller inte om användningen inte motsvarar apparatens standarder, inte heller vid skador som orsakas av ej tilltän ingrepp eller på grund av koparens vårdslöshet. Garantin gäller inte forskador som orsakats av att verktyget fungerat bristfälligt.

### FI. TAKUU

Taman laitteen takuu on voimassa sopimuksenmukaisesti kattaen kaikki rakenne- ja materiaali- ja lukien ostopaivasta kassakuittia vastaan. Takuu sisältää viallisten osien korvaamisen. Takuu ei korvaa ohjeidenvastaista käyttöä eikä ylituuttamattomien henkilöiden käsittelystä tai ostajan huolimattomuudesta aiheutuneita vahinkoja. Takuu ei vastaa myöskään toimint- ahairioista aiheutuneita vahinkoja.

Този инструмент е под договорна гаранция срещу всякакъв дефект в изработката и използваните материали, считано от датата на продажба на потребителя и само срещу представяне на касовата бележка. Гаранционното обслужване се състои в замяна на дефектните части. Настоящата гаранция не е валидна когато апаратът се използва по начин, несъответстващ на стандарта за работа с него, както и в случай на щети, нанесени от неоторизирани лица, или вследствие на проявена небрежност от страна на потребителя.

Гаранцията не покрива щети, произтекли вследствие на техническа неизправност на апарата.

### DA. GARANTI

Dette værktøj er dækket af en garantikontrakt for konstruktions- og materialefejl, som gælder fra købsdatoen ved visning af kassabon. Garantien består i at udskifte de defekte dele. Garantien dækker ikke fejl opstået som følge af anvendelse, som ikke overholder standarderne for apparatet, eller skader opstået ved ikke autoriserede indgreb eller sløshed fra brugerens side. Garantien dækker ikke skader opstået, fordi værktøjet har svigtet.

## SERVICE APRÈS VENTE - AFTER SALE SERVICE

FARGROUP EUROPE - 192, Avenue Yves Farge - 37700 St. PIERRE-des-CORPS - FRANCE

fargroup@fargroup.net

## GARANTIE - WARRANTY



### RO. GARANTIE

Acest aparat este garantat din punct de vedere contractual impotriva tuturor viciilor de constructie si de material, incepand de la data vanzarii lui catre utilizator si la simpla prezentare a bonului de casa. Garantia consta in inlocuirea componentelor defecte. Aceasta garantie nu se aplica in cazul exploatarii in alt mod decat cel recomandat de normele aparatului si nici in caz de stricaciuni provocate de interventii neautorizate sau prin neglijenta cumparatorului. Garantia nu se aplica asupra pagbelor cauzate de o defectare a aparatului.

### RU. ГАРАНТИЯ

Данный изделие обладает имеющей силой контракта гарантией, покрывающей все возможные дефекты изготовления материала. Гарантия вступает в силу с даты продажи изделия пользователю, для этого достаточно сохранить и предъявить полученный в кассе чек. Гарантия обязывает изготовителя заменить дефектные части изделия. В случае не соответствующего нормам использования изделия, несанкционированного демонтажа или ремонта или небрежного обращения действие гарантии прекращается. Гарантия не покрывает ущерба, возникшего в результате сбоя в работе изделия.

### TU. GARANTIA

Bu arac, satis tarihinden itibaren, kullanicinin sadesce vezne alindisini sunmasiyyla tum uretim ve malzeme hatasina karsi garantilidir. Garanti eksik olan kisimlari degistirir. Bu garanti aracin sartlarina uygun olmayan isleme durumunda, izin verilmeden kullanimlardan kaynaklanan hasarlarda veya alicinin istegi durumunda uygulanmaz. Garanti malzemenin bir eksikliginden meydana gelen bir zararda uygulanmaz.

### CS. ZARUKA

Pro tento nástroj platí smluvní záruka na všechny výrobní a materiálové vady od data prodeje uživateli a na základě předložení pokladního bloku. Záruka spočívá ve výměně vadných částí. Tato záruka neplatí v případě použití přístroje, které neodpovídá normám, ani v případě škod způsobených nepovolenými zásahy nebo nedbalostí ze strany kupujícího. Záruka se nevztahuje na škody způsobené závadou nástroje.

### SK. ZARUKA

Pre tento nástroj platí zmluva

vná záruka na všetky výrobné a materiálové chyby od dátumu predaja užívateľovi a na základe predloženia pokladničného bloku. Záruka spočíva vo výmene chybných častí. Táto záruka neplatí v prípade použitia prístroja, ktoré nezodpovedá normám, ani v prípade škod spôsobených nepovolenými zásahmi alebo nedbalosťou zo strany kupujúceho. Záruka sa nevzťahuje na škody spôsobené poruchou nástroja.

### HE. GARANTIA

הצגת המכונה קופה. האחריות-משמעה בחומר, החל מיום המכירה למשתמש עם האחריות לפי חוזה מפני כל ליקוי ביצור או על ידי התערבות תלם הי עלכל זה חלה שאינו מתאים לתקנים ובמקרה של נזק שנגרם זו אינה חלה במקרה של שימוש במכשיר תקלה בכלי. החלף תחלקם הקלויים אחריות האחריות אינה חלה על נזק שנגרם על ידי סמכות או על ידי רשלנות מאת הקונה.

### AR. الضمان

على مجرد تقديم بطاقة الشراء يتعلّق من تاريخ البيع إلى المستعمل وبنءا على فني التصدي عوفى الجوانب، اعتباراً أنّ هذه آلة دة مصنوعة تعاقدياً من أي الجوانب، ولا في حالة تعرضه لتللفات حالة الاستعمال غير المطابق لمعايير لا يكون هذا الضمان قابلاً للتطبيق في ظلّ الضمان فني استبدال الأجزاء الأعطالة لا ينطبق الضمان على الصيود الناتج عن عرضة أو في حالة الإدمال من قبل المشتري. باتّة عن عيوبك تدخل غير

### HU. GARANCIA

Erre a szerszámra szerződéses garanciát vállalunk bármilyen gyártási és anyaghiba felmerülése esetére, a fogyasztó részére történt eladás napjától számítva, a penztári blokk egyszerű felmutatása elleneben. A garancia a hibás alkatrészek cserejére terjed ki. Ez a garancia nem érvényes, ha a készüléket nem rendeltetésszerűen használták, sem illetéktelen beavatkozások, vagy a vásárló hanyagsága okozta károk esetén. A garancia nem fedezi azokat a károkat, melyeket a szerszám hibás működése okozott.

### SI. GARANCIJA

To gorodje je z garancijsko pogodbo zašciteno proti vsem napakam v izdelavi in v sestavnem materialu od datuma prodaje naprej in ta velja ob predložitvi blagajniškega računa. Garancija velja za zamenjavo delov z napako. Ta garancija ne velja za uporabo orodja, ki ni v skladu z normami, predpisanimi za omenjeno orodje in za primere okvar, ki nastanejo zaradi nedovoljenih posegov na orodju ali zaradi malomarnega rokovanja kupca. Garancija ne velja za škodo, ki jo lahko povzroči okvara orodja.

### ET. GARANTII

See toorist kuulub lepingu järgi garantiiremonti arvestades alates müumise päevast ja kassatseki alusel kasutajale koigi konstruktsiooni- ja materjalivigade puhul. Garantii

seisneb defektsete osade väljavahetamisest. See garantii ei kehti aparadi normide ebatavalise eiramise puhul ega ostja poolt keelatud viisil kasutamiseist või hooletussejätmisest tulenevate kahjude korral. Garantii ei kehti seadme defektidest põhjustatud kahjude puhul.

### LV. GARANTĪJA

Sis prietaisus yra uztikrinamas kaip itin geros kokybes, nuo jo pardavimo datos iki jo panaudojimo, ir jam yra suteikiamas garantinis taikomas. Garantijos metu galima pakeisti atsiradusius trumplaiakius gedimus. Si garantija netaikoma esant netinkamam naudojimui ar nesilaikant reikiamu sio aparato vartojimo instrukciju, tai pat paciam pirkeju ji sugadinus. Garantija taip pat netaikoma, prietaisa naudojant ne pagal paskirti ir ji apgadinus.

### LT. GARANTĪJA

Sim darbarikam ir liguma noteikta garantija visiem defektiem, kas saistās ar konstrukciju un materiālu, sakot ar pārdošanas datumu, kad mašīnu, pardot lietotājam un vienkarši uzrādot kases čeku. Garantija iekļauj bojāto daļu nomaiņu. Si garantija nav derīga, ja aparāts nav lietots saskaņā ar drošības noteikumiem, ne gādājums ja bojājumi radusies nēsākcionētās, iekļausanas gadijuma vai arī pircēja nolaidības dēļ. Garantija nav derīga, ja bojājumi radusies darbarikā defekta dēļ.

### HR. JAMSTVO

Ovaj alat ima ugovorno jamstvo u slučaju bilo kakvih nedostataka u konstrukciji i materijalu, od datuma prodaje korisniku (uz jednostavno predocenje racuna. Jamstvo se sastoji u zamjeni neispravnih dijelova. Ovo je jamstvo ne primjenjuje u slučaju uporabe i eksploatacije koja nije sukladna standardima uređaja, niti u slučaju štete uzrokovane neovlaštenim intervencijama ili nemanom kupca. Jamstvo se ne primjenjuje na štetu uzrokovanu nekim nedostatkom alata.

## SERVICE APRÈS VENTE - AFTER SALE SERVICE

FARGROUP EUROPE - 192, Avenue Yves Farge - 37700 St. PIERRE-des-CORPS - FRANCE

fargroup@fargroup.net



## FAR GROUP EUROPE

Une société du groupe **SIGMA**

192, Avenue Yves Farge  
37700 St. Pierre-des-Corps  
FRANCE

[fartools.com](http://fartools.com)

