

CASANOVO

VEYMONT 350C160

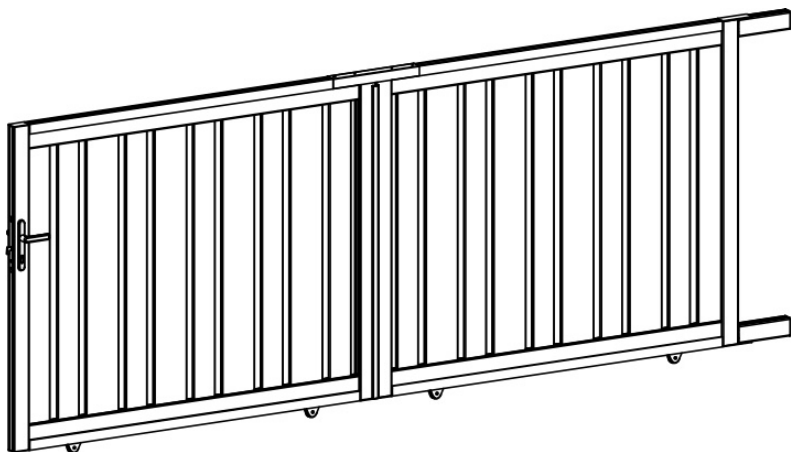

COM-000847 [x1]

COM-000849 [x1]

COM-000848 [x1]



7-8H



X 2



INSTRUCTION MANUAL / NOTICE DE MONTAGE / MONTAGEANLEITUNG / MANUAL DE MONTAJE / MANUAL DE MONTAGEM / MANUALE DI MONTAGGIO /
MONTAGEHANDLEIDING / INSTRUKCJA MONTAŻU / KÄYTTÖOHJEET / BRUKSANVISNING / BRUGSANVISNING / INSTRUCIUNI DE ASAMBLARE /
NAVODILA ZA SESTAVLJANJE / NÁVOD NA MONTÁŽ / ÖSSZESZERELÉSI ÚTMUTATÓ / NÁVOD K MONTÁŽI / UPUTE ZA INSTALACIJU /
ΟΔΗΓΙΕΣ ΣΥΝΑΡΜΟΛΟΓΗΣΗΣ / SURINKIMO INSTRUKCIJOS / MONTŽAS INSTRUKCIJAS

Ext.

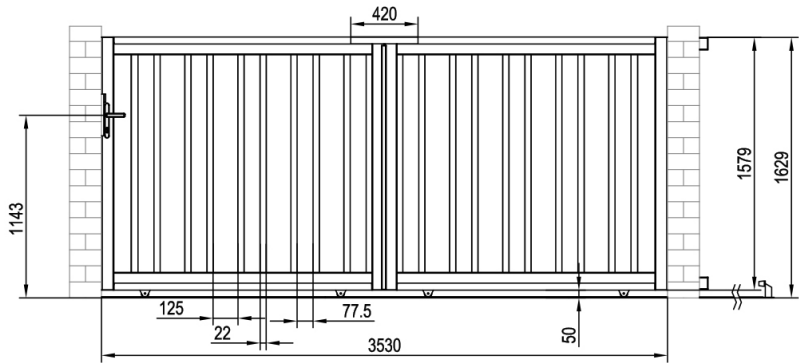

Int.

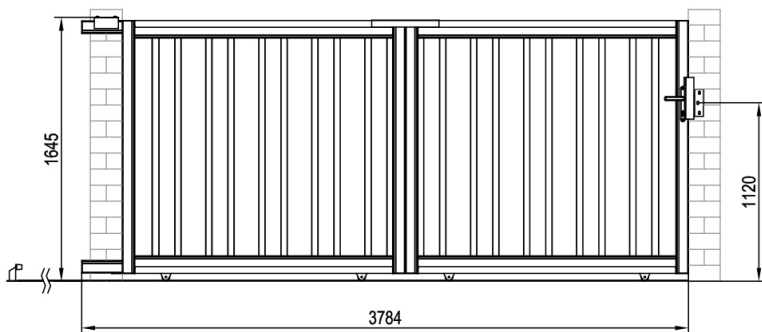

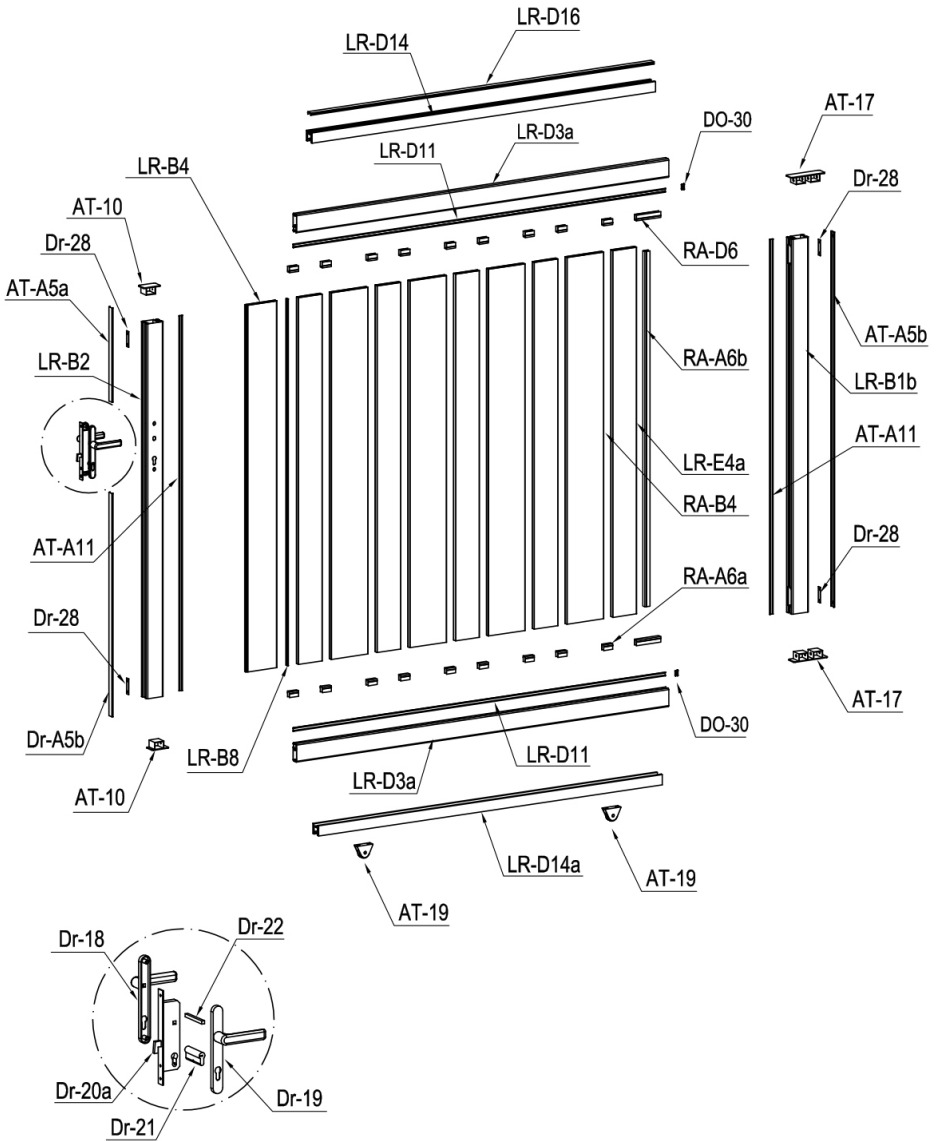

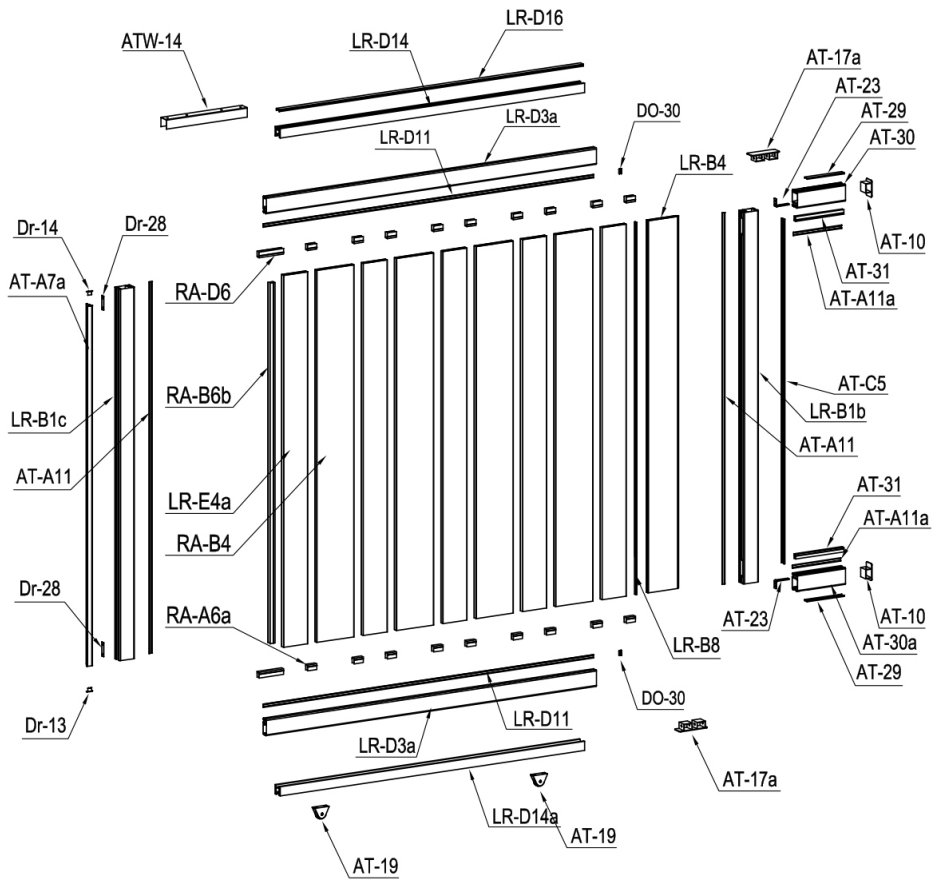

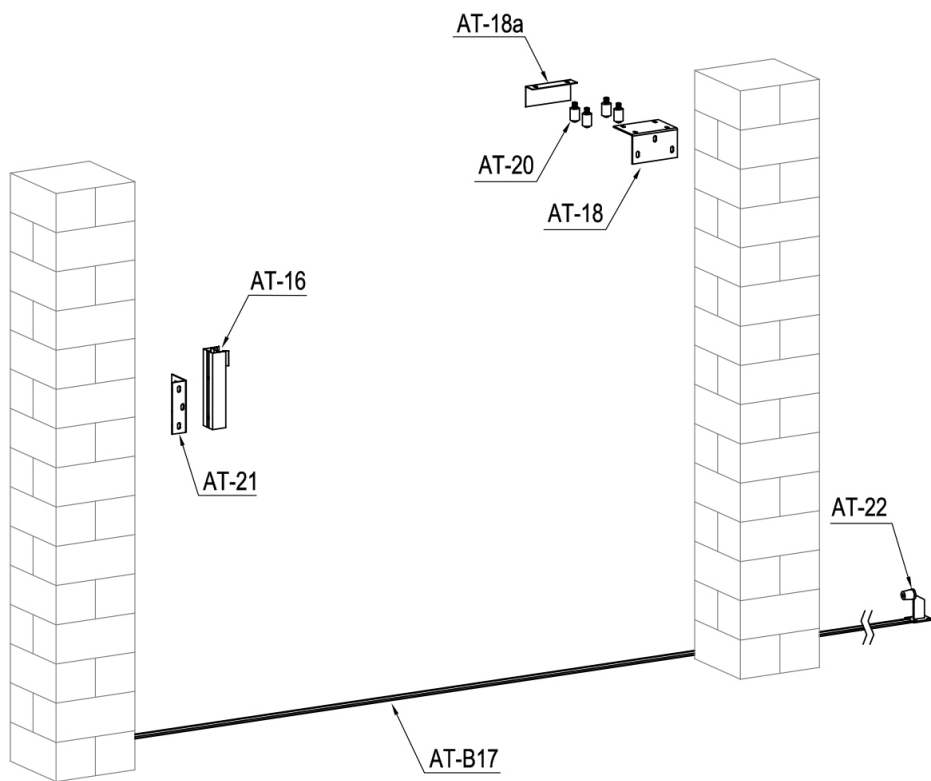



















































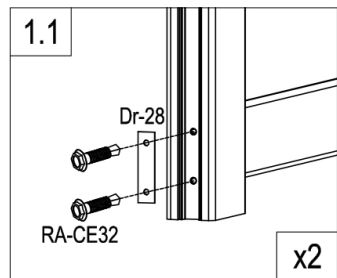
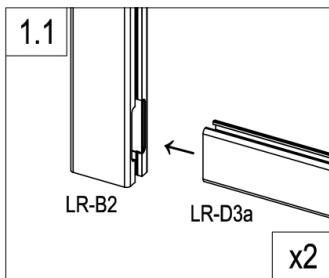
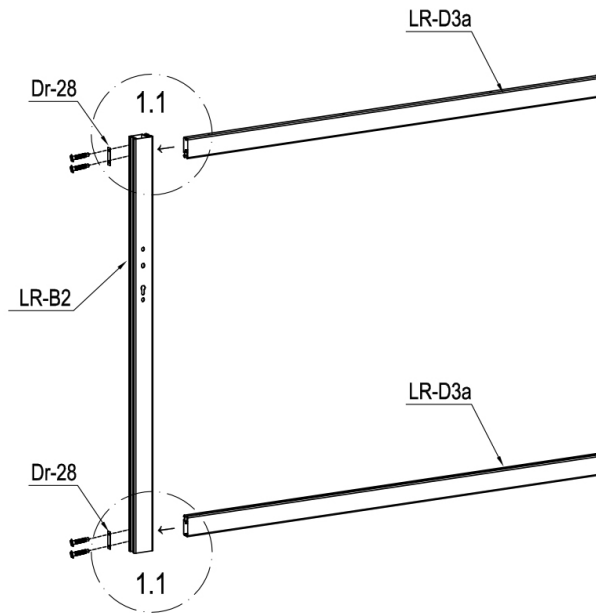

CASANOVO

IMAGE	NO.	L.(mm)	QTY	IMAGE	NO.	L.(mm)	QTY
	LR-B1b	1573	2		Dr-13		1
	LR-B1c	1573	1		Dr-14		1
	LR-B2	1573	1		DO-30		4
	AT-30	250	1		AT-18	150	1
	AT-30a	250	1		AT-18a	150	1
	LR-D3a	1742	4		ATW-14	420	1
	LR-B4	1400	2		AT-19		4
	RA-B4	1400	8		AT-20		4
	LR-D4a	1400	10		AT-21		1
	AT-A5b	1573	1		AT-22		1
	AT-C5	1448	1		AT-23		2
	AT-A5a	395.5	1		Dr-18		1
	Dr-A5b	937	1		Dr-19		1
	AT-29	193	2		Dr-20a		1
	AT-A11	1573	4		Dr-21		1
	AT-A11a	250	2		Dr-22		1
	LR-D11	1742	4		Dr-25	M5x45	1
	AT-31	250	2		Dr-25a	M5x60	2
	RA-A6a	38	36		Dr-27	ST4.2x25	2
	RA-B6b	1357	2		Dr-28		6
	RA-D6	102	4		AT-22J		7
	LR-B8	1400	2		RA-CE30	ST4x10	4
	AT-A7a	1520	1		RA-CE31	M8x60	10
	LR-D14	1608	2		RA-CE32	ST5.5x38	32
	LR-D14a	1608	2		RA-CE33	M8x130	4
	LR-D16	1607	2		RA-CE34	ST4.8x38	12
	AT-16		1		RA-CE35	ST4.2x19	62
	AT-B17	1412	5		RA-CE36	M6x20	2
	AT-17		2		RA-CE37	M8x20	8
	AT-17a		2		RA-CE38	M4x25	50
	AT-10		4				



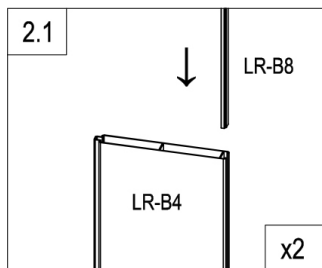
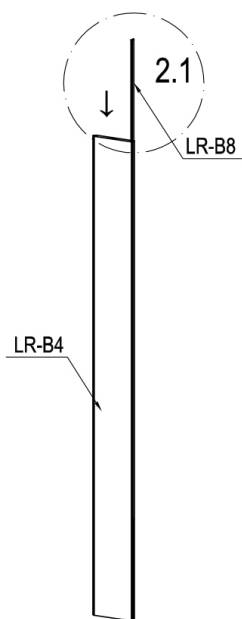

	LR-B2	1
	LR-D3a	2
	Dr-28	2
	RA-CE32	4

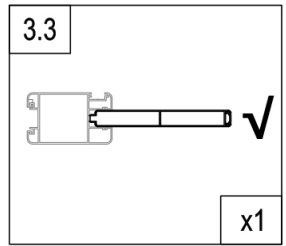
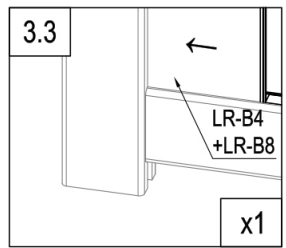
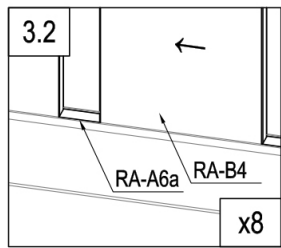
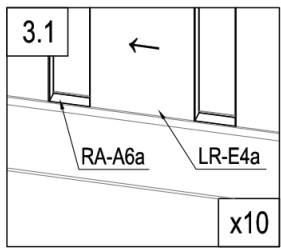
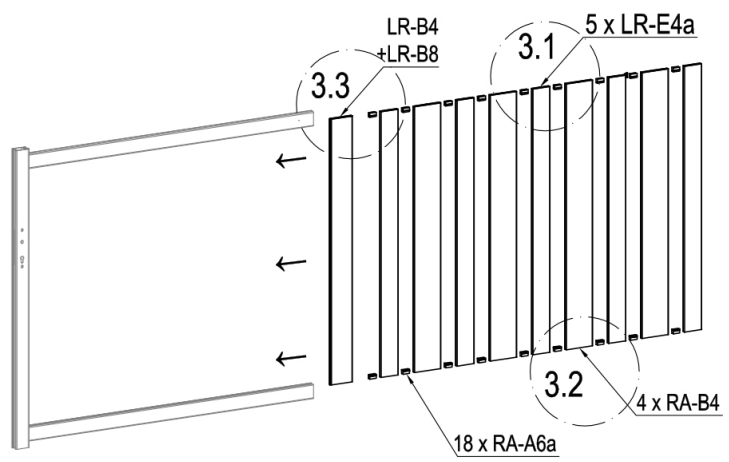

	LR-B8	1
	LR-B4	1





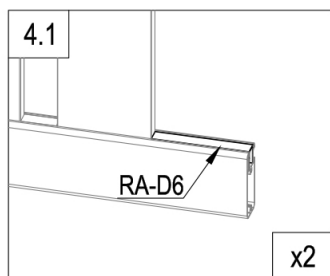
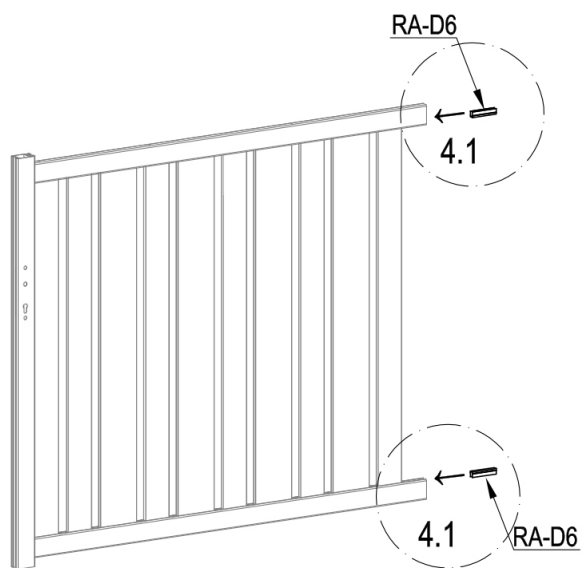

	RA-B4	4
	LR-E4a	5
	RA-A6a	18

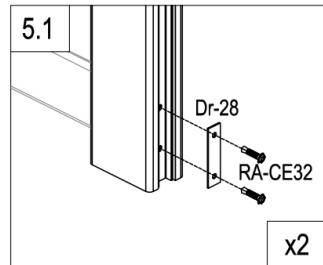
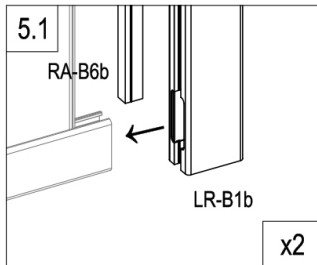
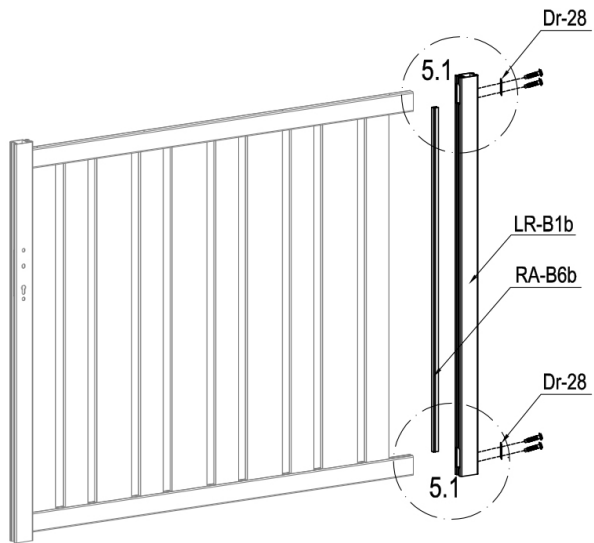

	RA-D6	2
---	-------	---



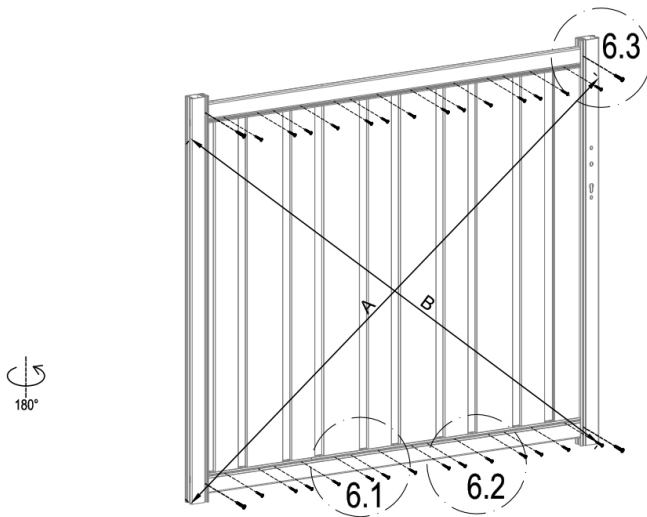

	LR-B1b	1
	RA-B6b	1
	Dr-28	2
	RA-CE32	4

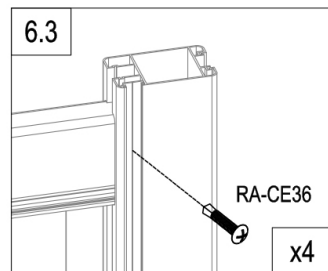
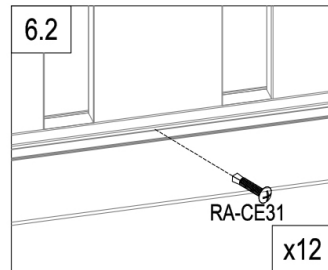
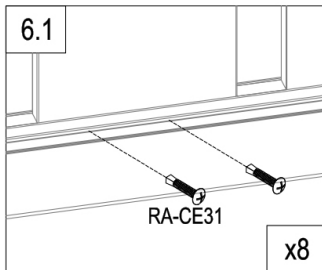

A=B



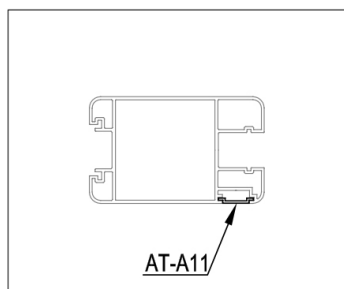
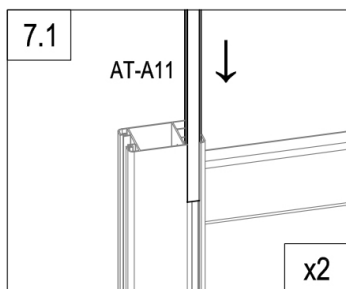
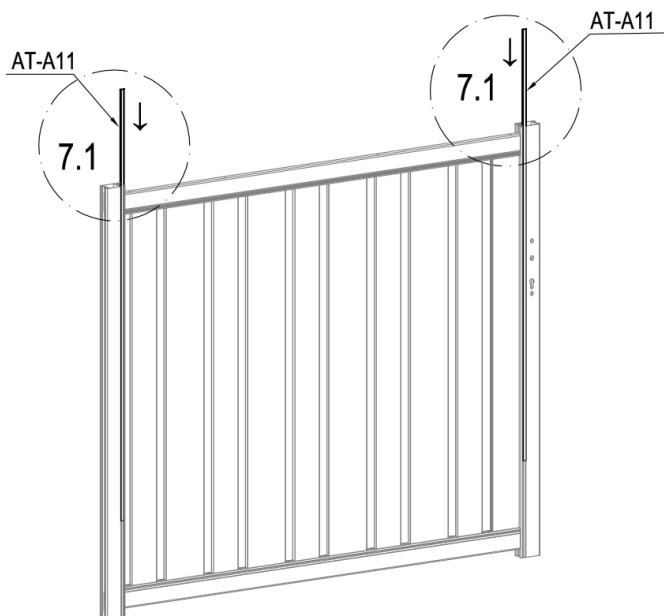

	RA-CE31	28
	RA-CE36	4

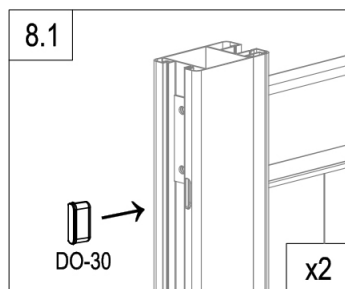
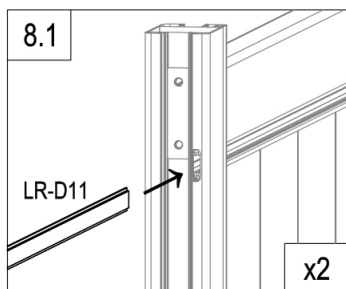
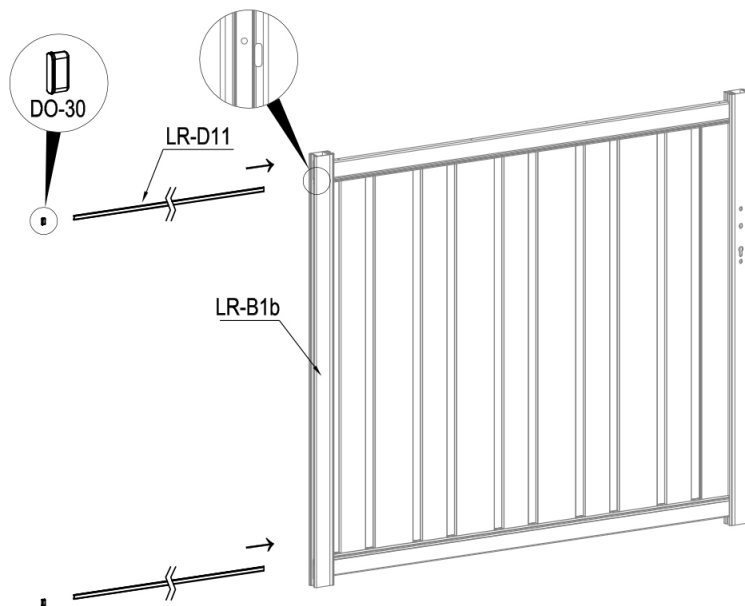

	AT-A11	2
---	--------	---



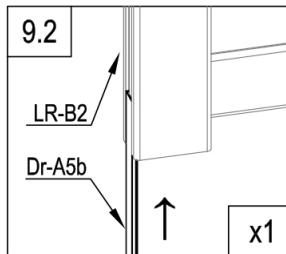
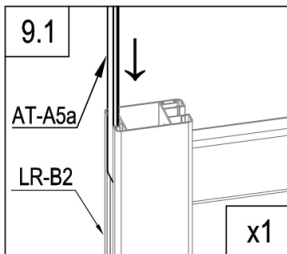
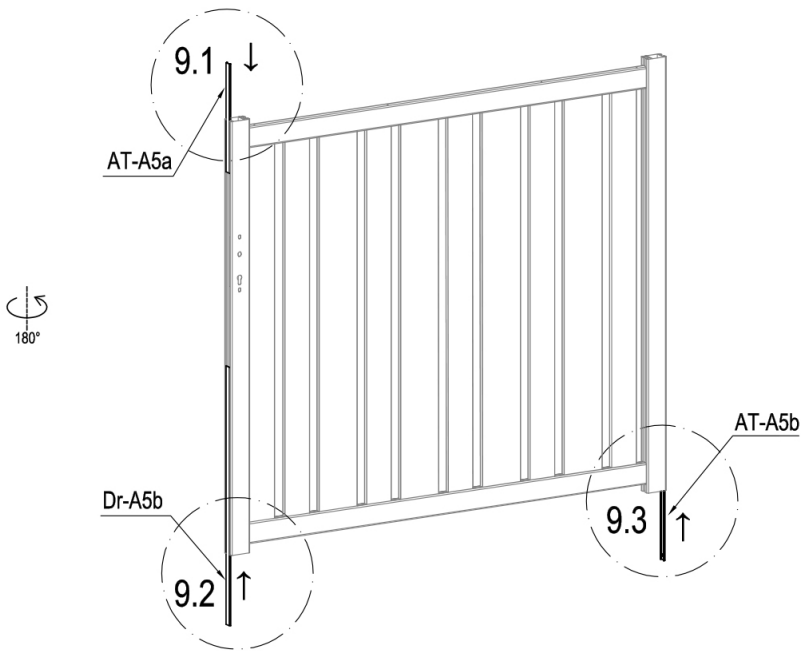

	LR-D11	2
	DO-30	2



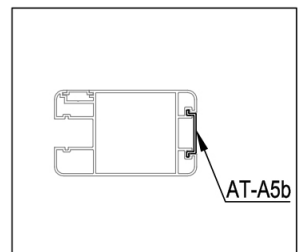

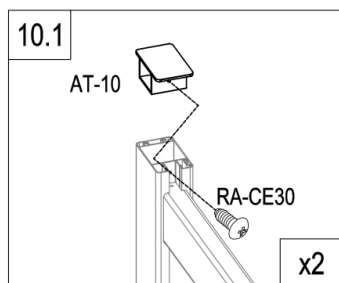
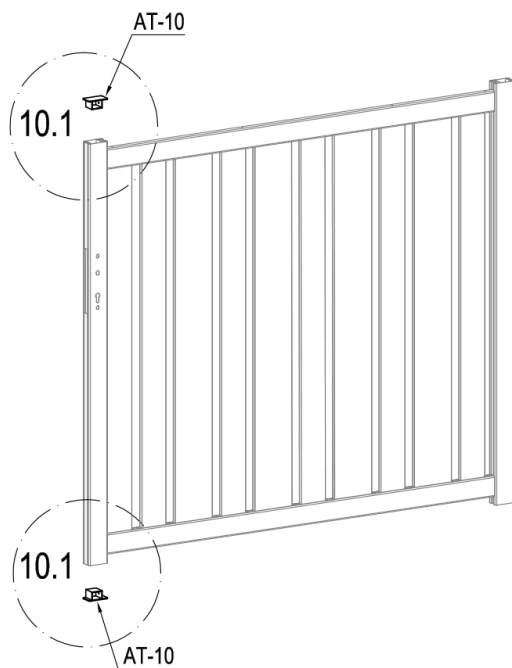

	AT-A5b	1
	AT-A5a	1
	Dr-A5b	1



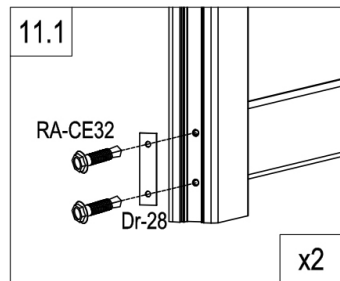
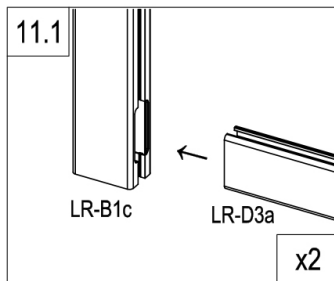
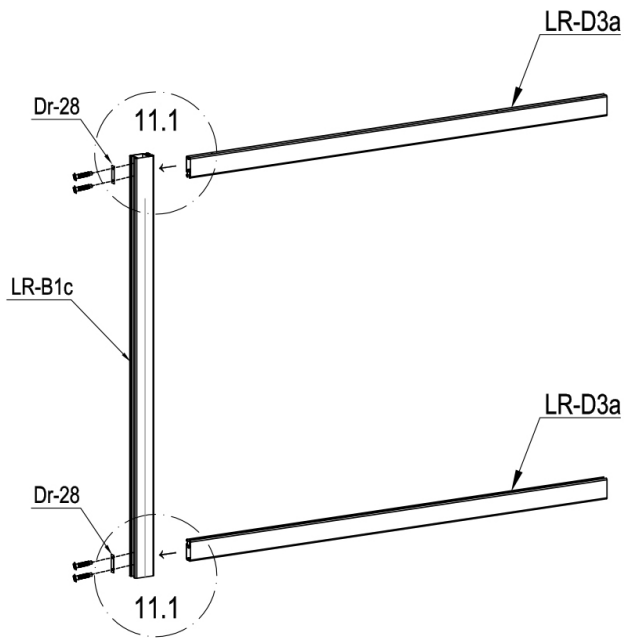



	AT-10	2
	RA-CE30	2

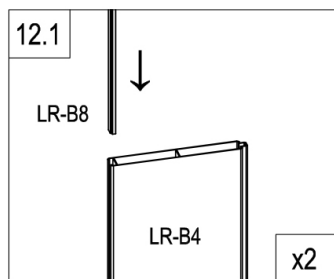
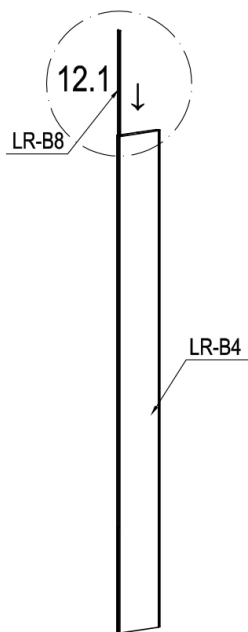

	LR-B1c	1
	LR-D3a	2
	Dr-28	2
	RA-CE32	4



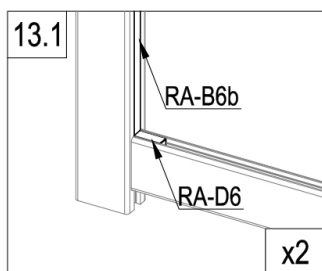
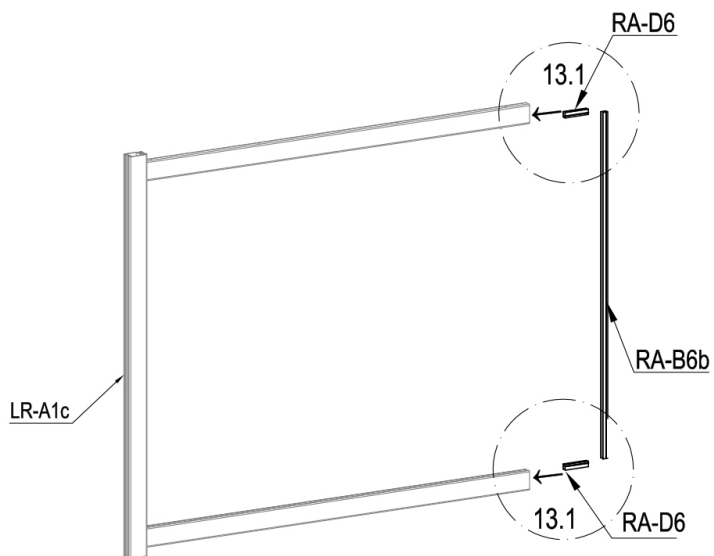

	LR-B8	1
	LR-B4	1



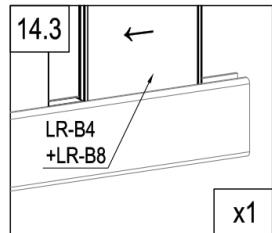
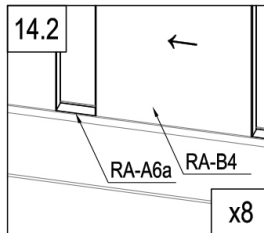
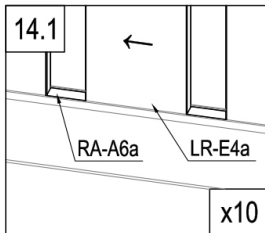
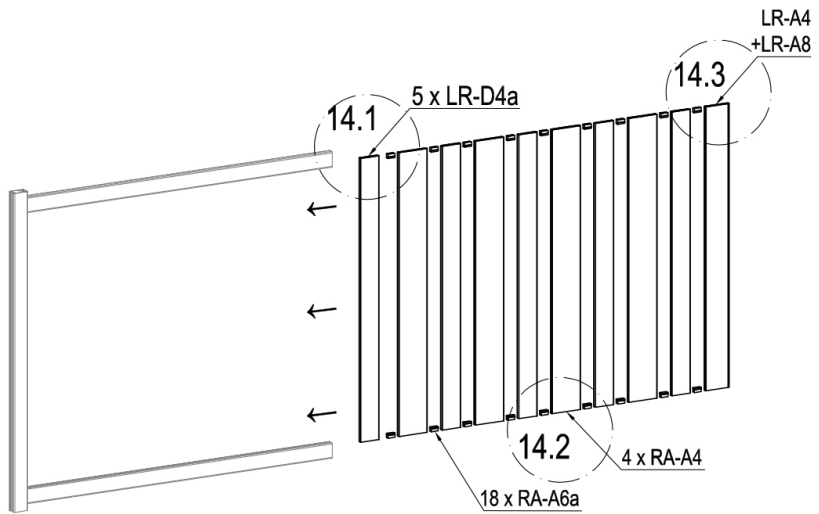

	RA-D6	2
	RA-B6b	1

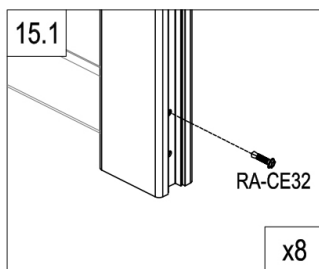
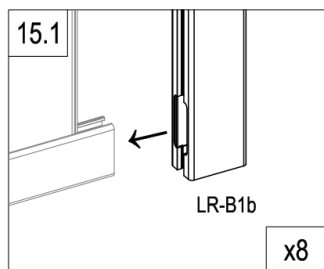
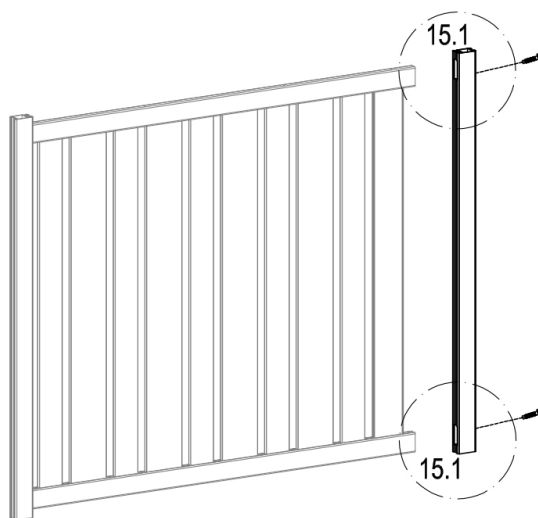

	RA-A4	4
	LR-D4a	5
	RA-A6a	18



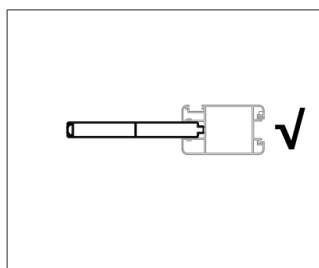

	LR-B1b	1
	RA-CE32	2

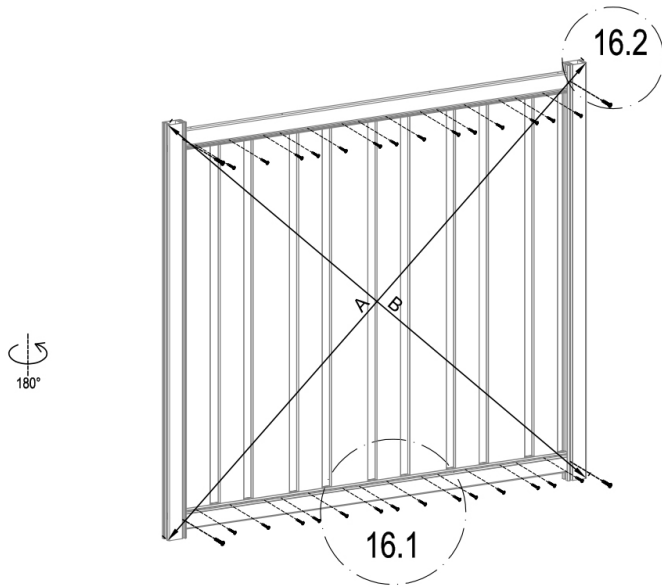



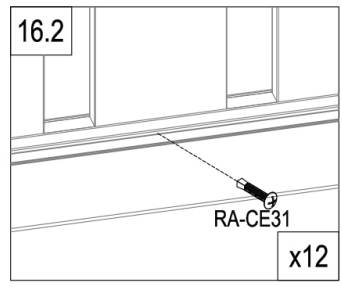
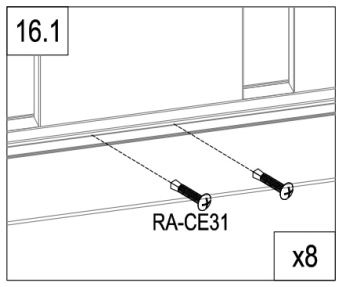

A=B



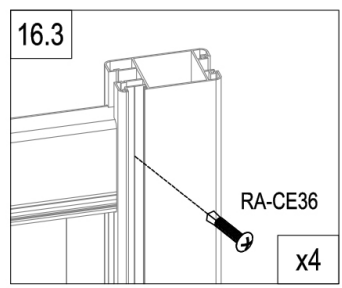

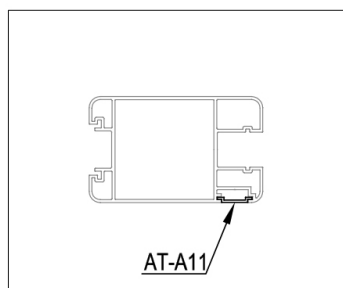
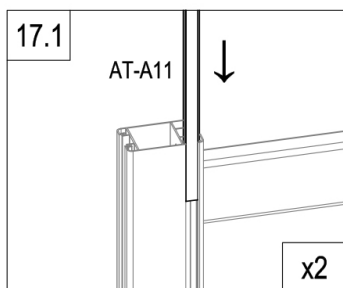
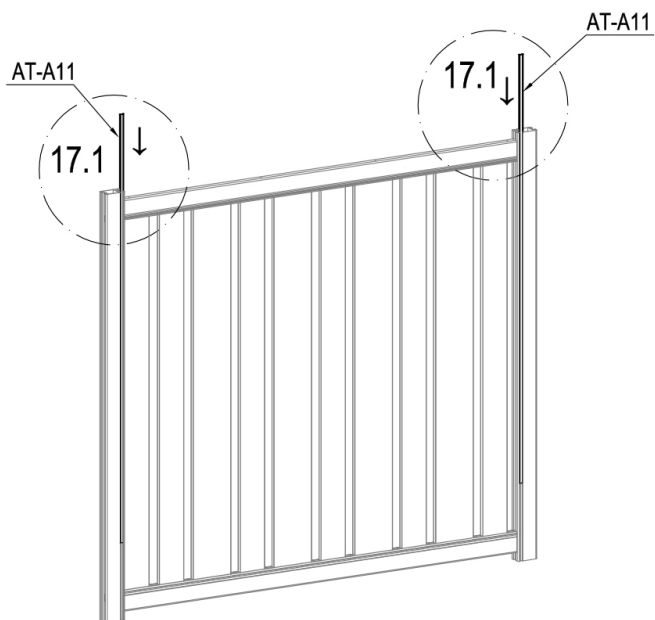
	RA-CE31	28
	RA-CE36	4





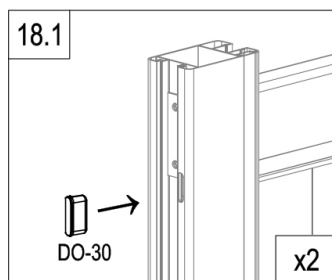
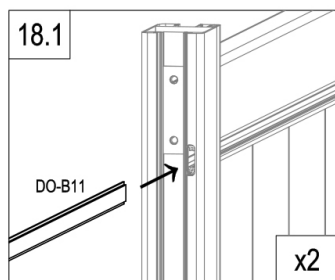
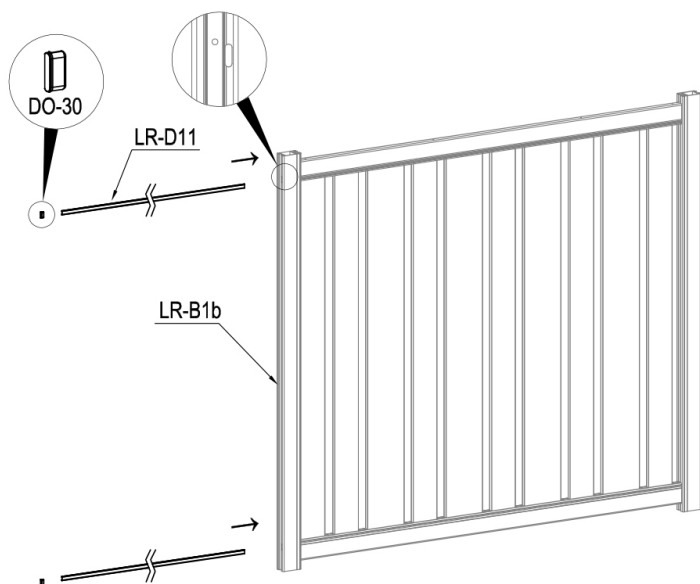



	AT-A11	2
---	--------	---

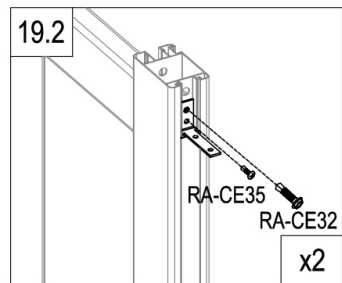
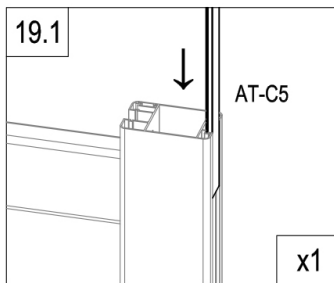
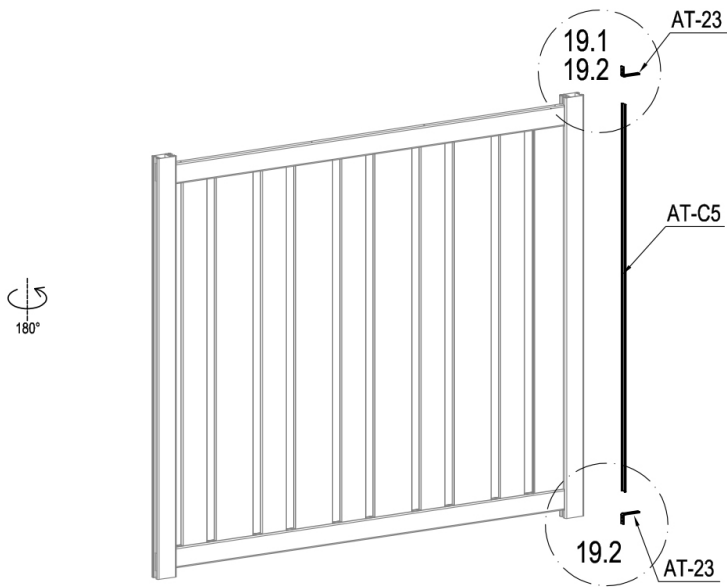

	DO-B11	2
	DO-30	2



	AT-C5	1
	AT-23	2
	RA-CE32	2
	RA-CE35	2

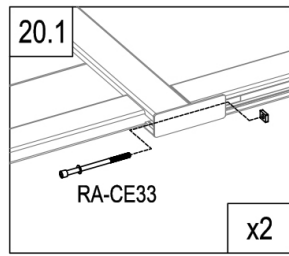
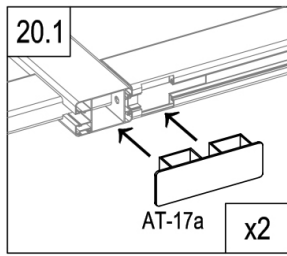
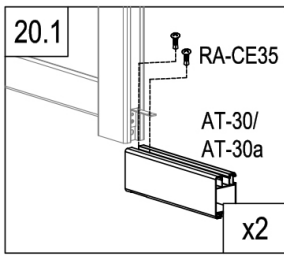
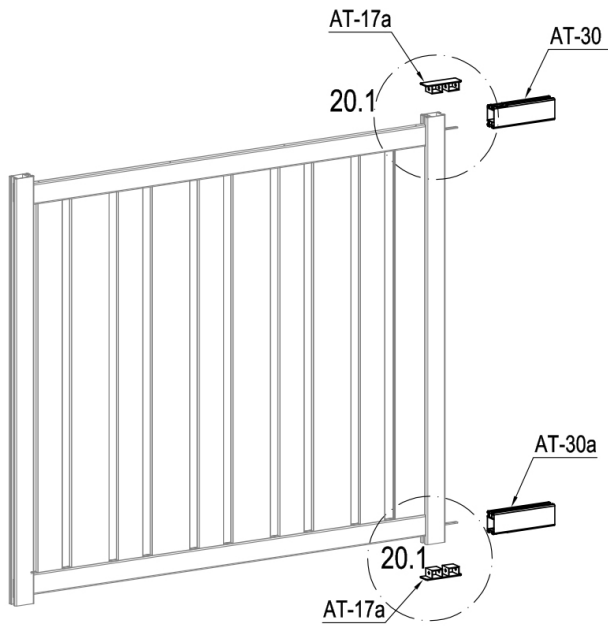

	AT-30	1
	AT-30a	1
	AT-17a	2

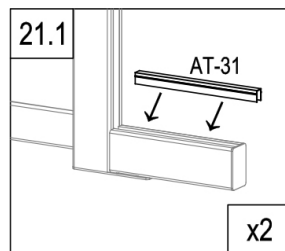
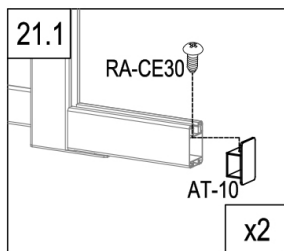
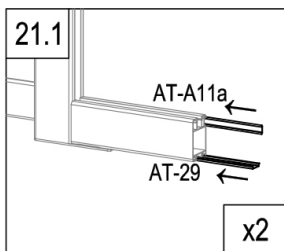
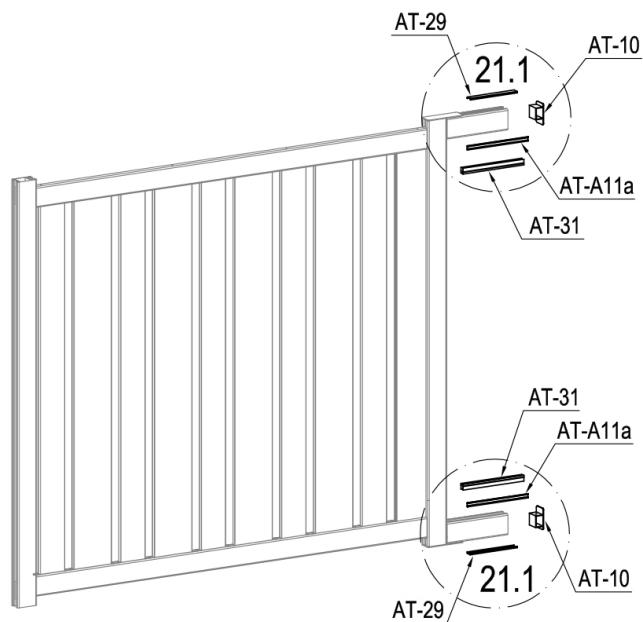

	RA-CE33	2
	RA-CE35	4



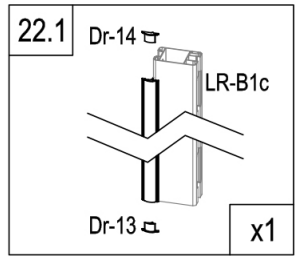
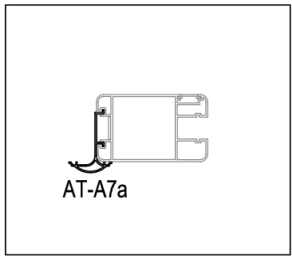
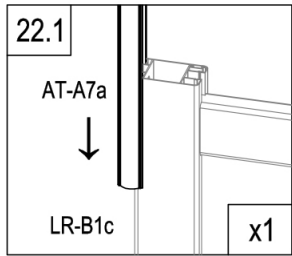
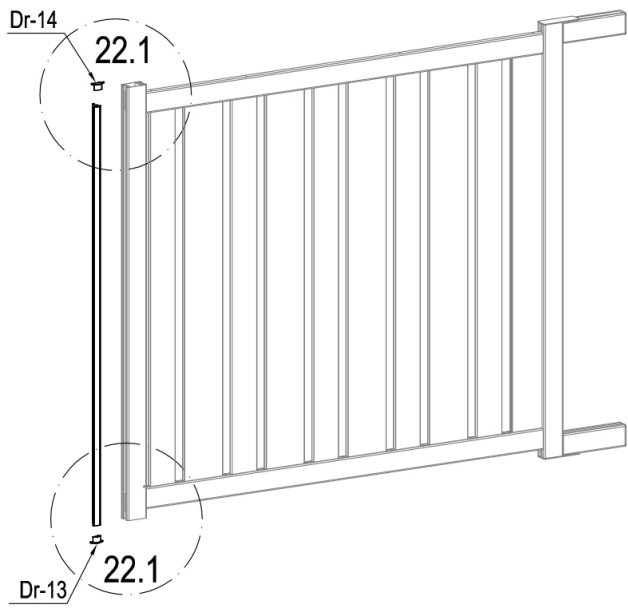

	AT-29	2
	AT-A11a	2
	AT-31	2

	AT-10	2
	RA-CE30	2

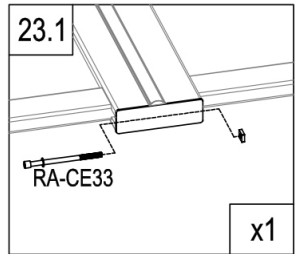
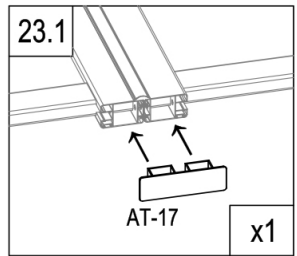
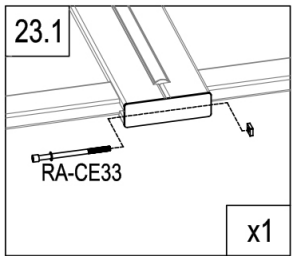
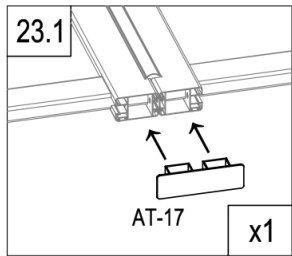
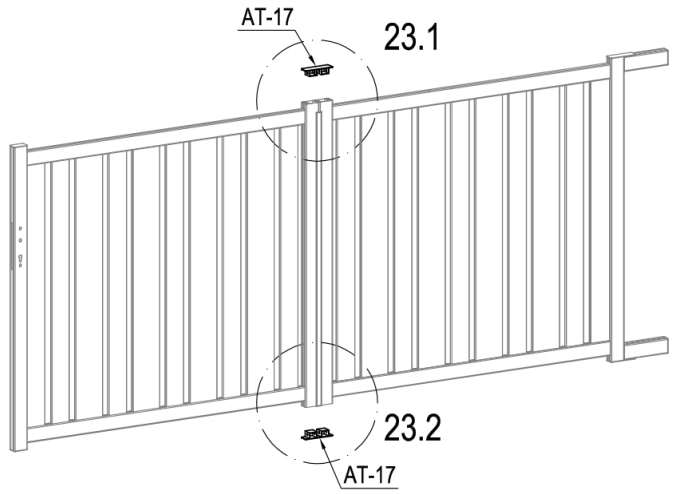

	AT-A7a	1
	Dr-13	1
	Dr-14	1



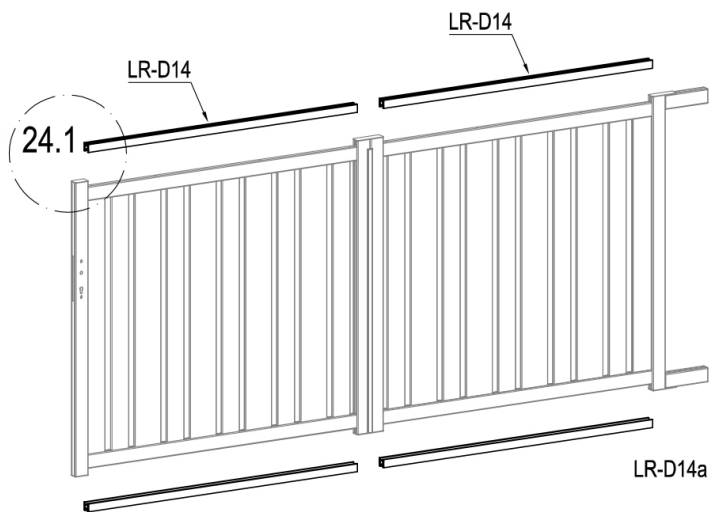

	AT-17	2
	RA-CE33	2





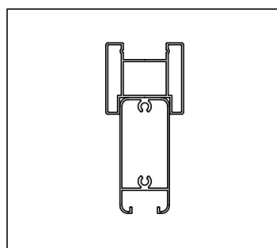
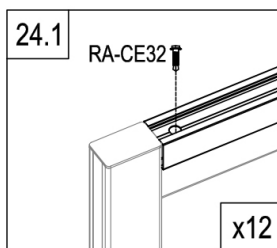
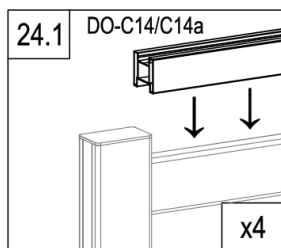

LR-D14a

EN: These parts are made for connecting your gate's automation
 FR: Ces pièces sont faites pour relier l'automatisation de votre portail
 DE: Diese Teile sind für den Anschluss der Automatisierung Ihres Tores vorgesehen
 ES: Estas piezas están hechas para conectar la automatización de su puerta
 PT: Estas peças são feitas para ligar a automatização do seu portão
 IT: Queste parti sono realizzate per collegare l'automazione del vostro cancello
 NL: Deze onderdelen zijn gemaakt voor het aansluiten van de automatisering van uw poort.
 PL: Te części są wykonane do podłączenia automatyki bramy.

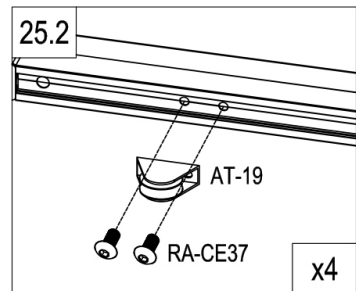
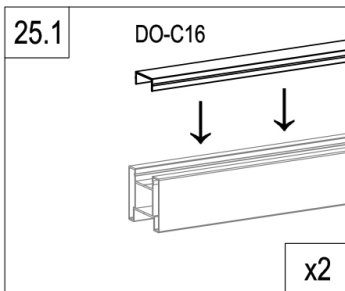
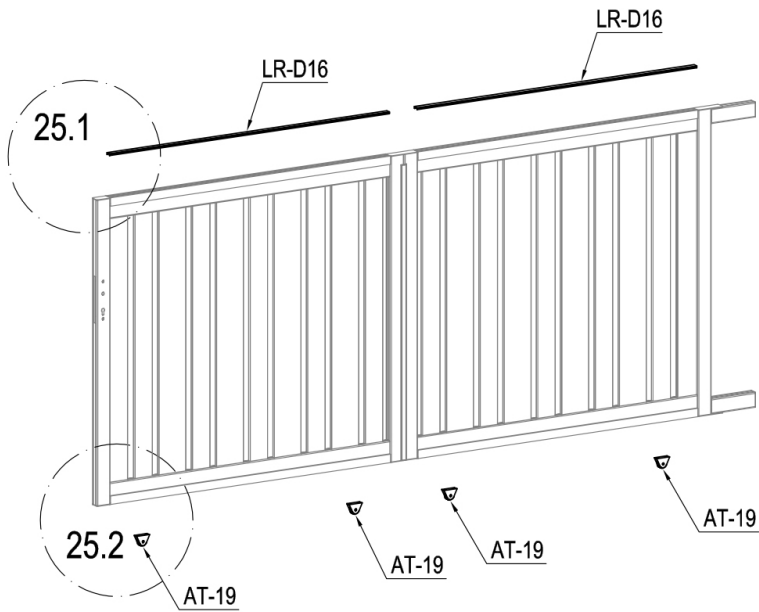



	DO-C14	2
	DO-C14a	2
	RA-CE32	12

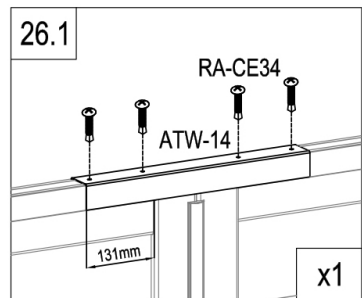
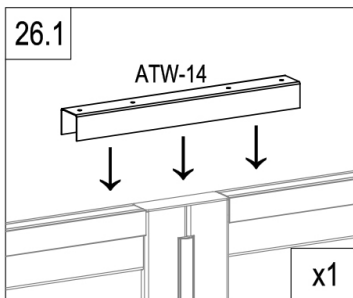
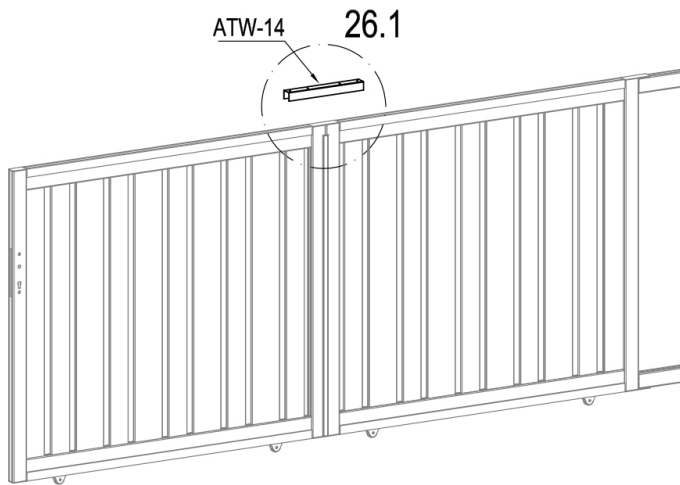

	DO-C16	2
	AT-19	4
	RA-CE37	8



	ATW-14	1
	RA-CE34	4

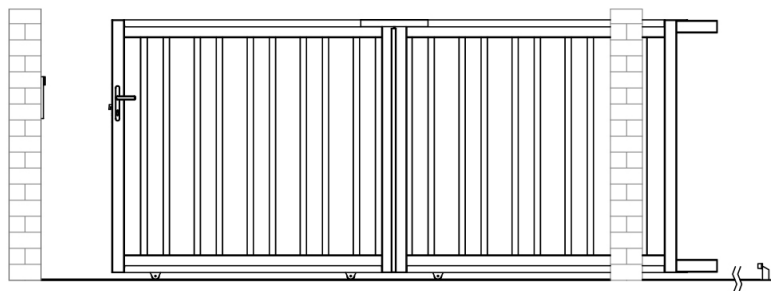

L

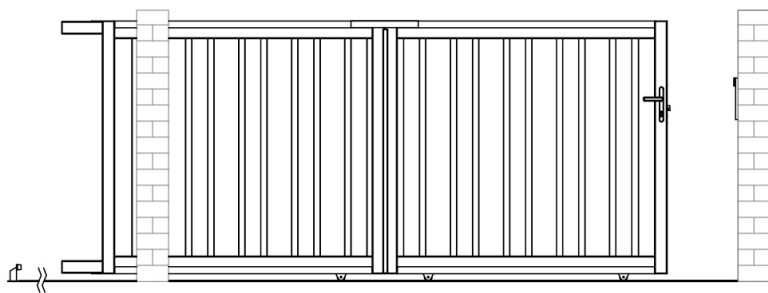

R

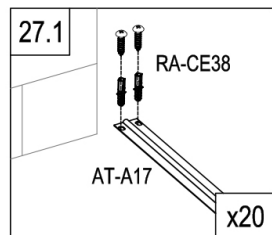
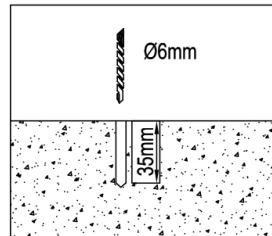
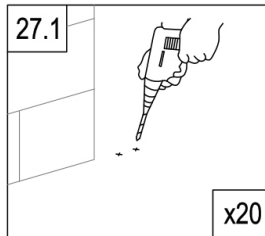
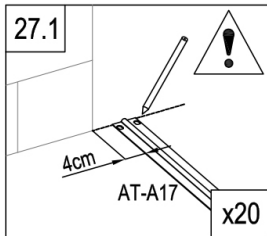
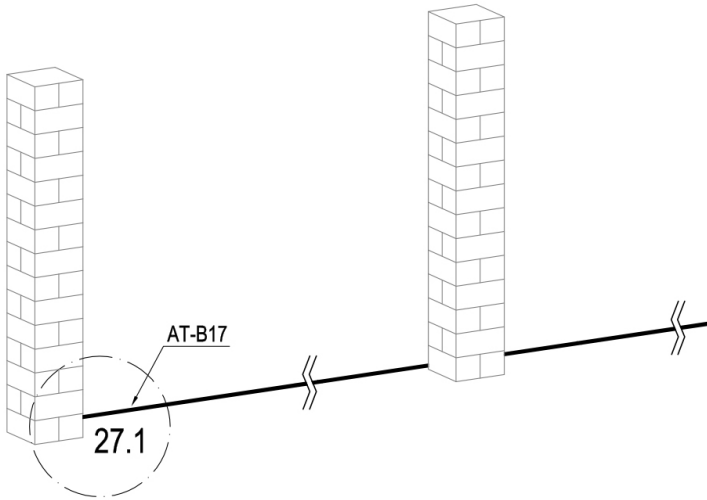

	AT-A17	5
	RA-CE38	40

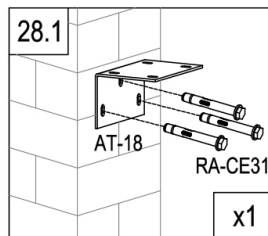
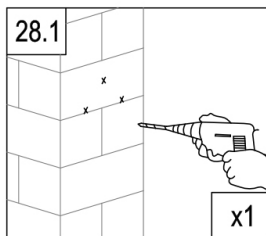
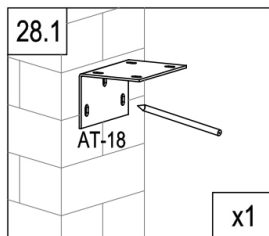
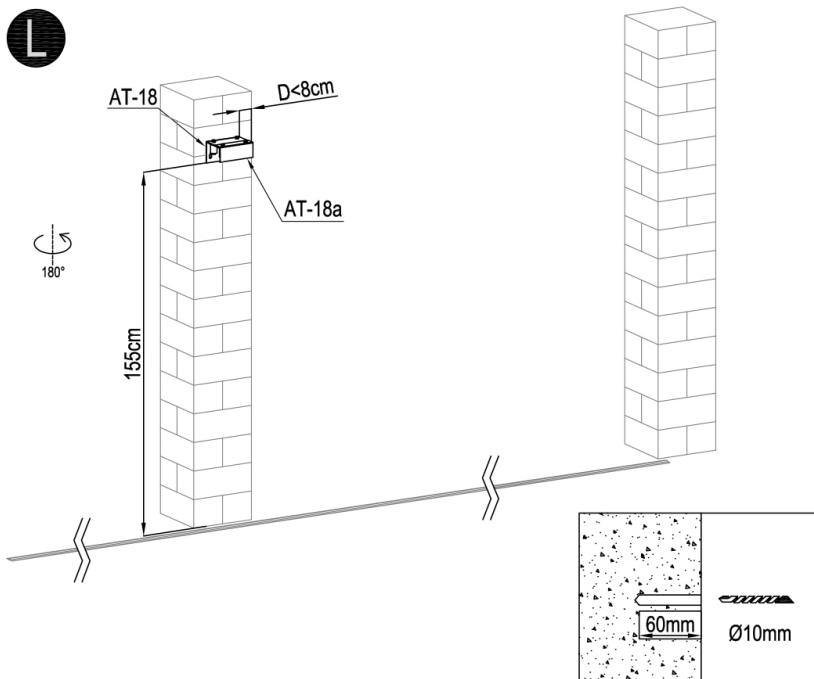

	AT-18	1
	AT-18a	1
	AT-20	4
	RA-CE31	3

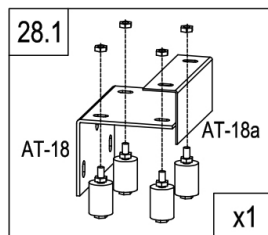
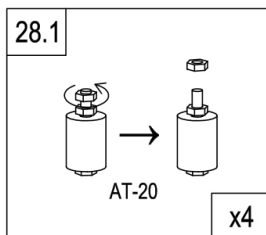

L

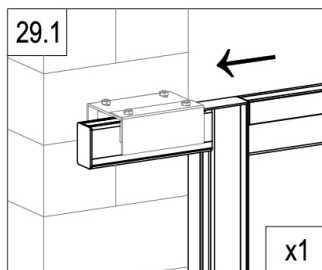
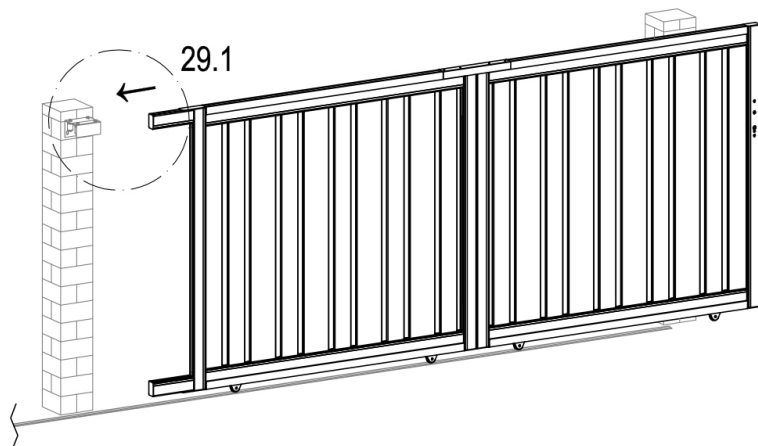

L

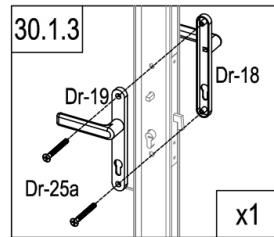
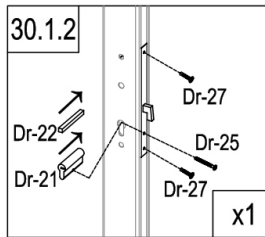
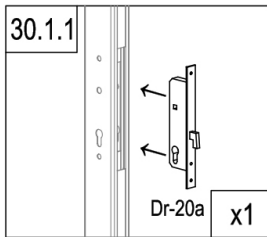
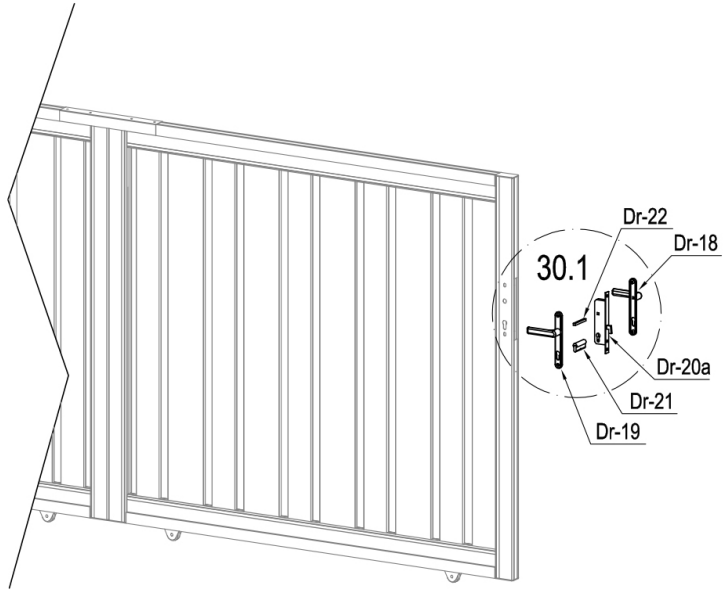

	Dr-20a	1
	Dr-21	1
	Dr-22	1
	Dr-25	1

	Dr-18	1
	Dr-19	1
	Dr-25a	2
	Dr-27	2

L

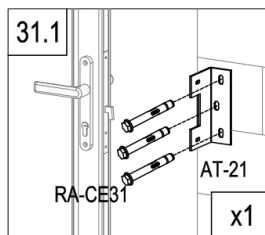
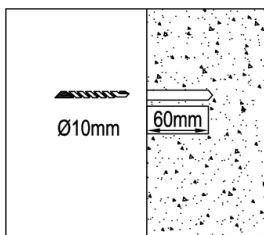
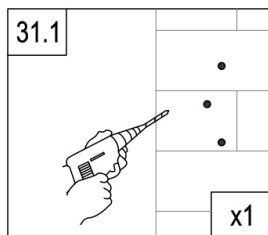
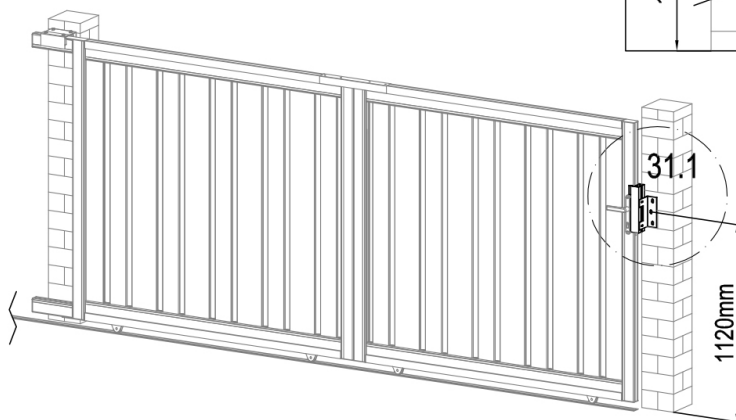
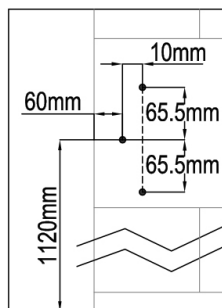

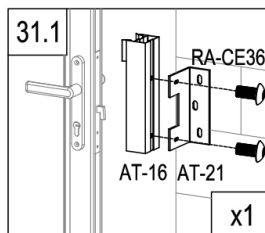
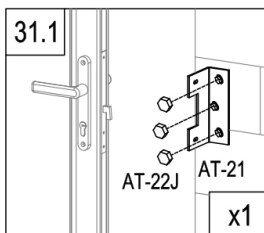

	AT-16	1
	AT-21	1
	RA-CE36	2
	RA-CE31	3
	AT-22J	3

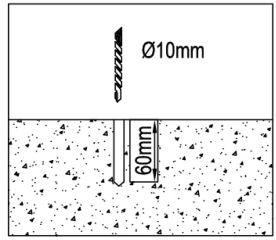
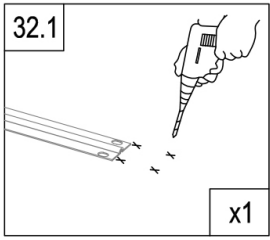
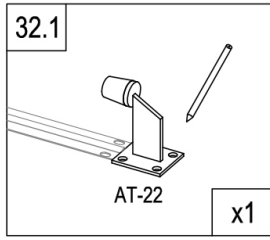
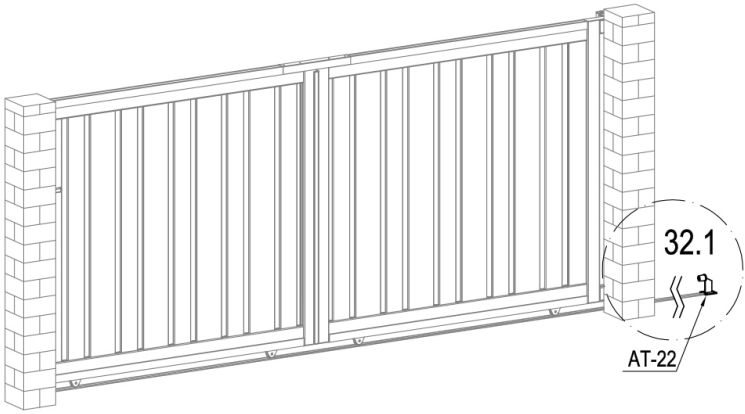

L



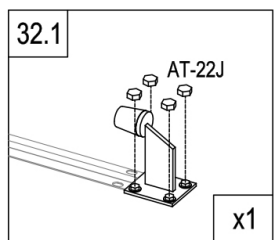
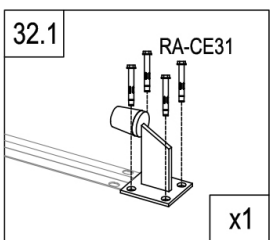

	AT-22	1
	RA-CE31	4
	AT-22J	4

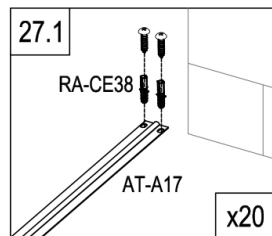
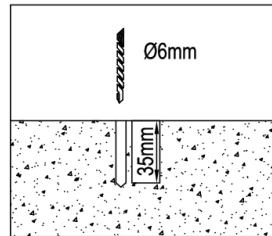
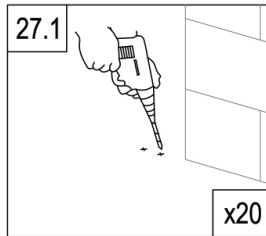
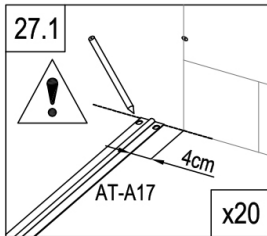
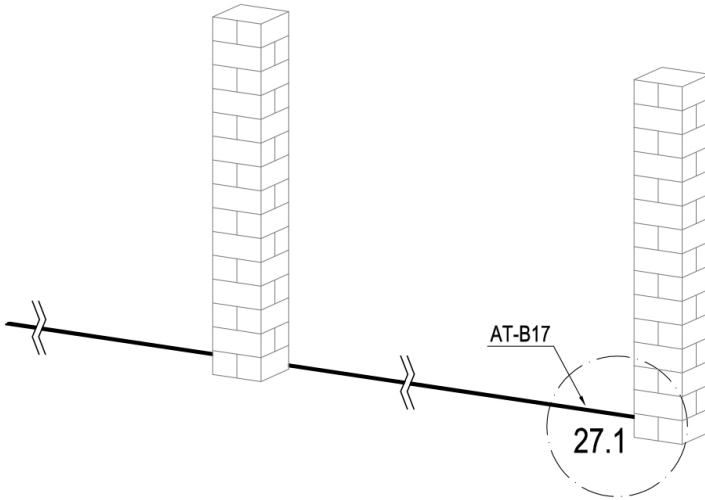

R



	AT-A17	5
	RA-CE38	40

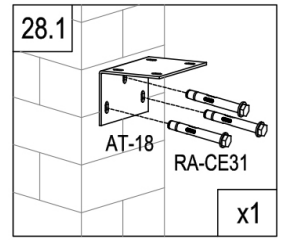
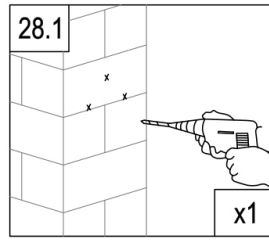
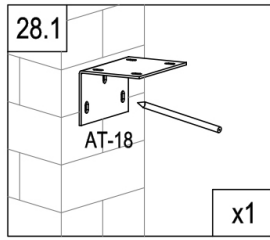
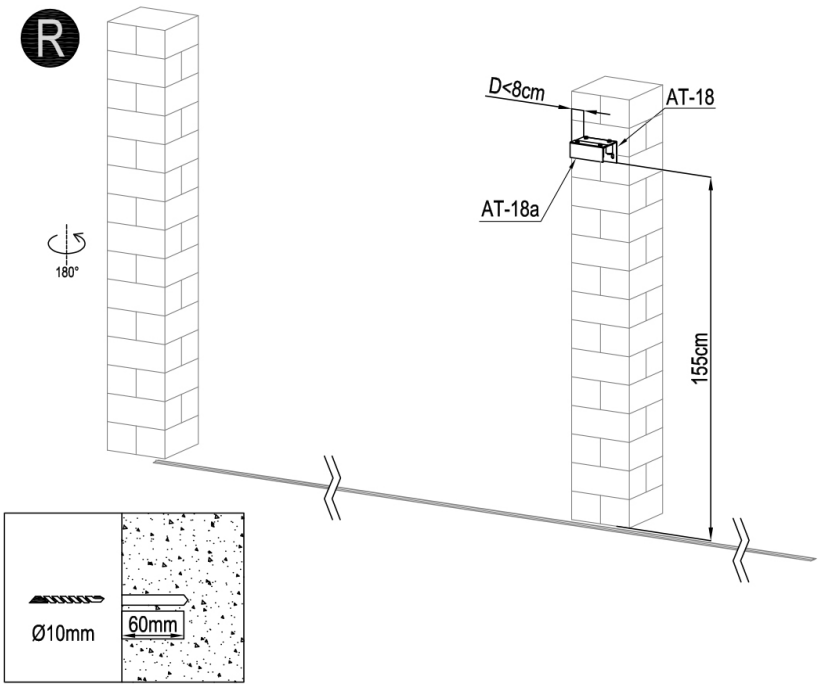

	AT-18	1
	AT-18a	1
	AT-20	4
	RA-CE31	3

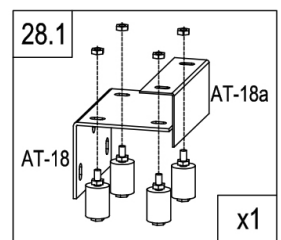
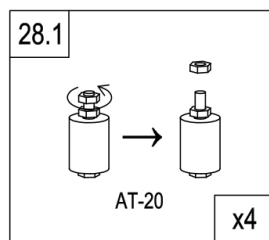

R

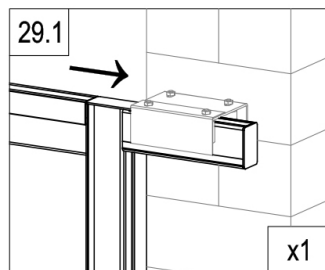
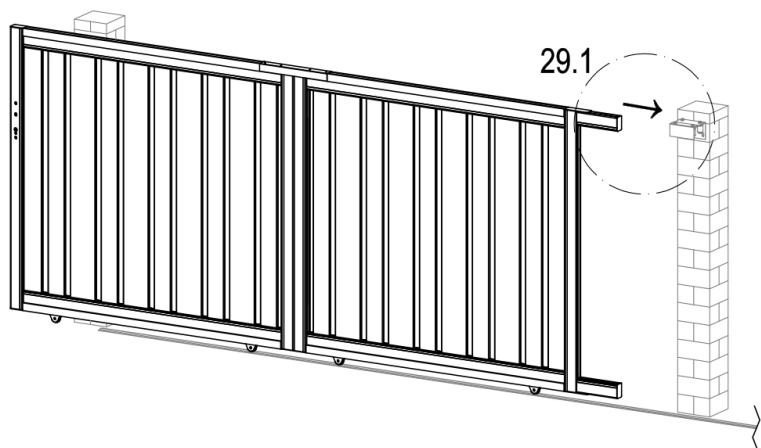

R

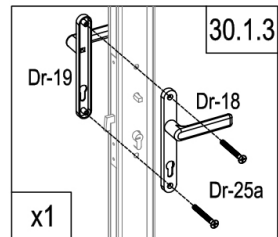
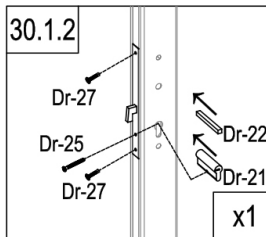
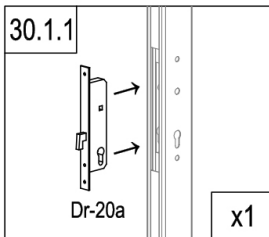
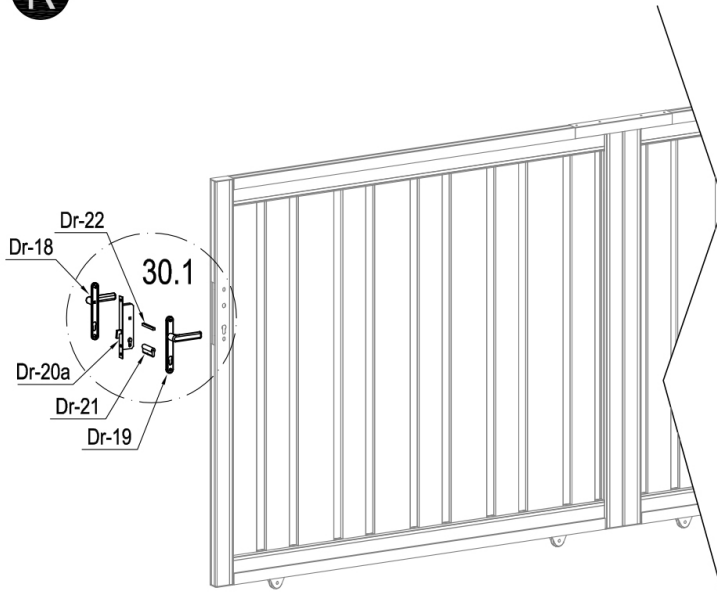

	Dr-20a	1
	Dr-21	1
	Dr-22	1
	Dr-25	1

	Dr-18	1
	Dr-19	1
	Dr-25a	2
	Dr-27	2

CASANOVO

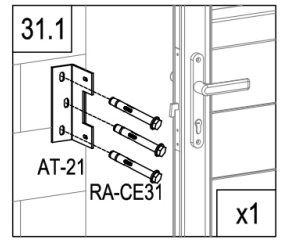
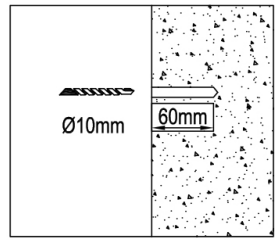
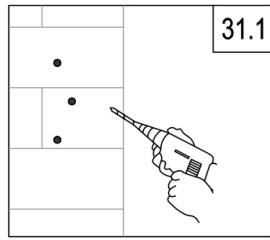
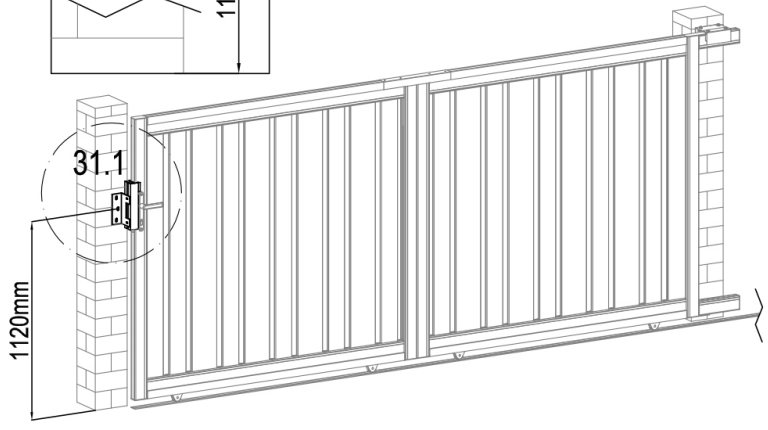
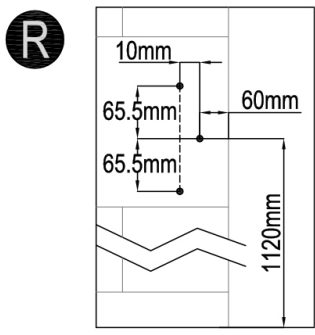

	AT-16	1
	AT-21	1
	RA-CE36	2
	RA-CE31	3
	AT-22J	3

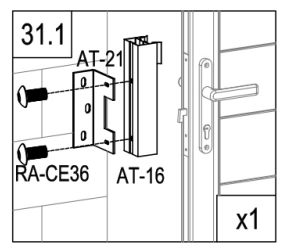
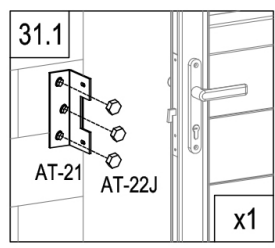

R

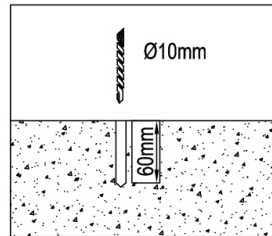
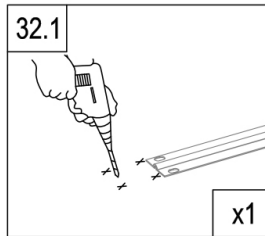
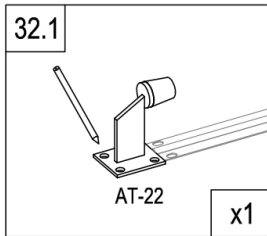
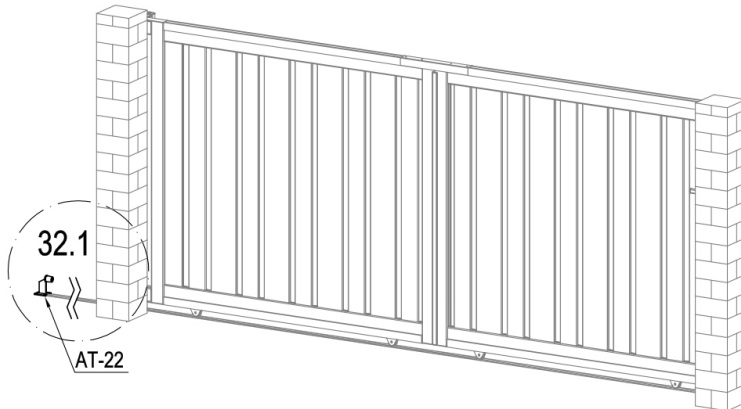

	AT-22	1
	RA-CE31	4
	AT-22J	4

