

CASANOVO

VEYMONT 400C160

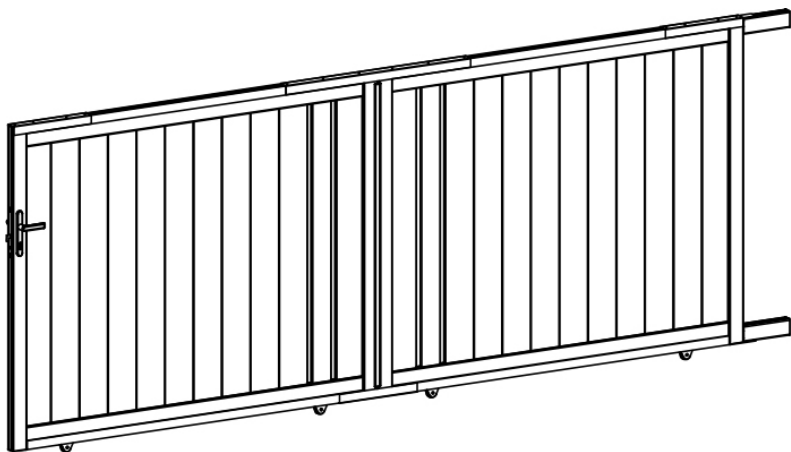

COM-000853 [x1]

COM-000855 [x1]

COM-000854 [x1]



5-7H



X 2



INSTRUCTION MANUAL / NOTICE DE MONTAGE / MONTAGEANLEITUNG / MANUAL DE MONTAJE / MANUAL DE MONTAGEM / MANUALE DI MONTAGGIO /
MONTAGEHANDLEIDING / INSTRUKCJA MONTAŻU / KÄYTTÖOHJEET / BRUKSANVISNING / BRUGSANVISNING / INSTRUCȚIUNI DE ASAMBLARE /
NAVODILA ZA SESTAVLJANJE / NÁVOD NA MONTÁŽ / ÖSSZESZERELÉSI ÚTMUTATÓ / NÁVOD K MONTÁŽI / UPUTE ZA INSTALACIJU /
ΟΔΗΓΙΕΣ ΣΥΝΑΡΜΟΛΟΓΗΣΗΣ / SURINKIMO INSTRUKCIJOS / MONTĀŽAS INSTRUKCIJAS

Ext.

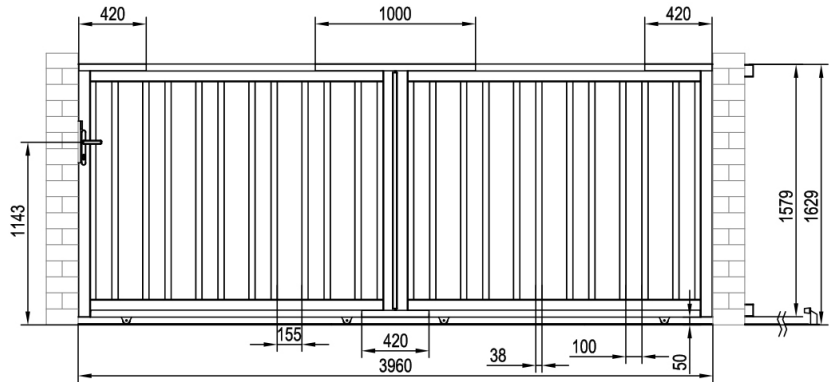

Int.

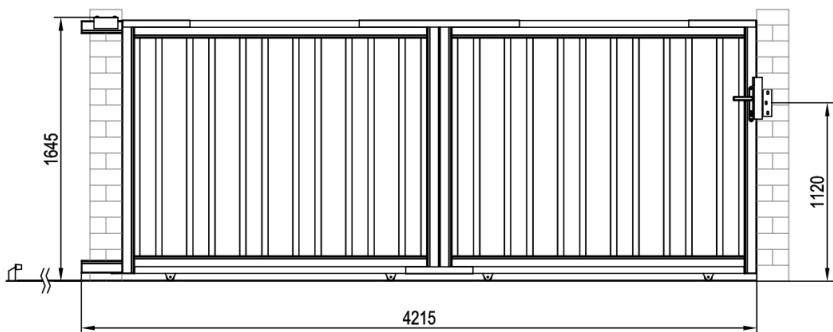

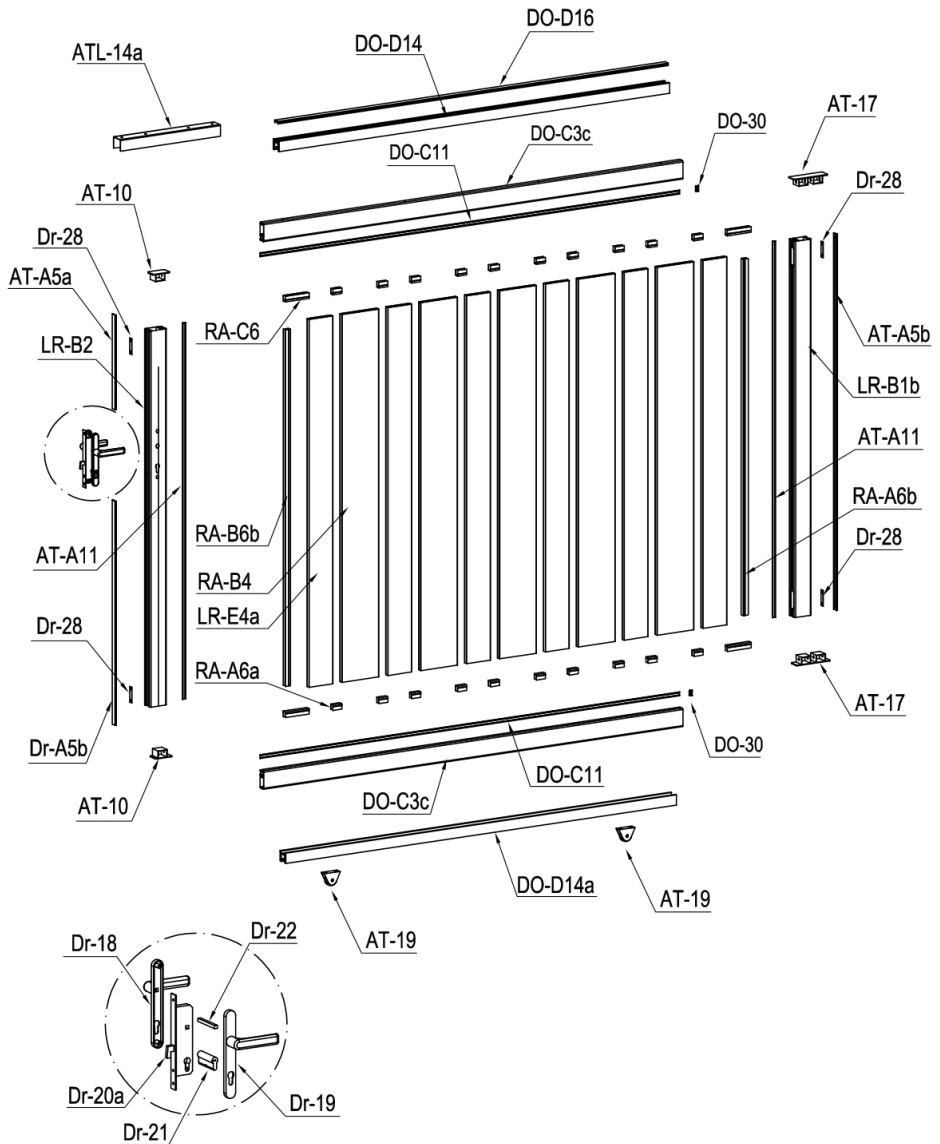

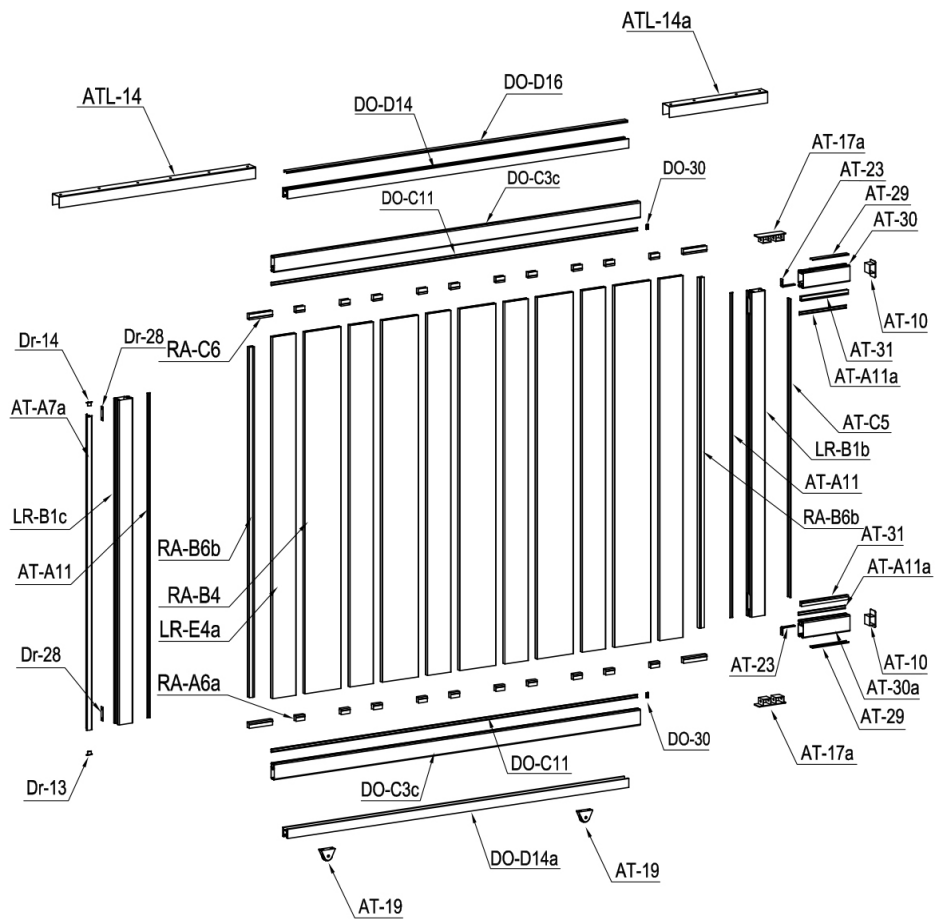

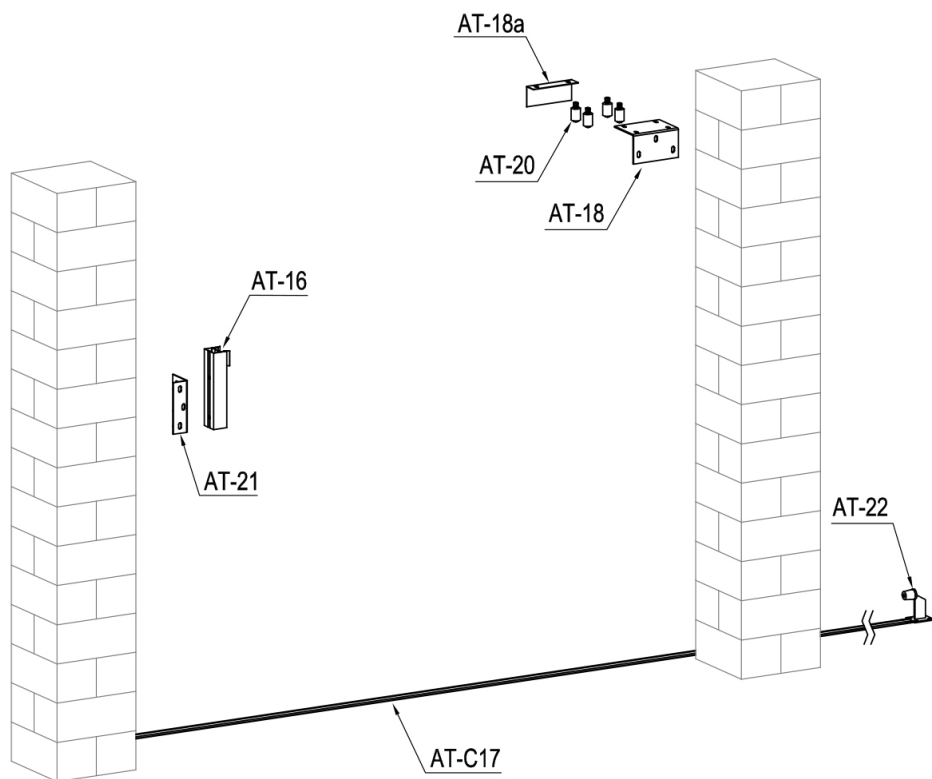













































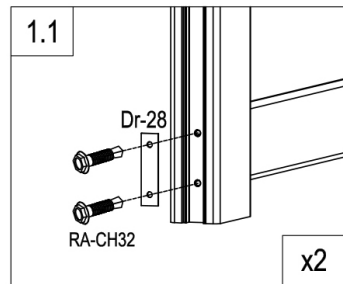
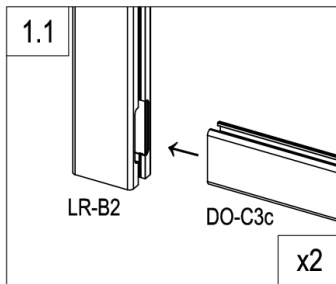
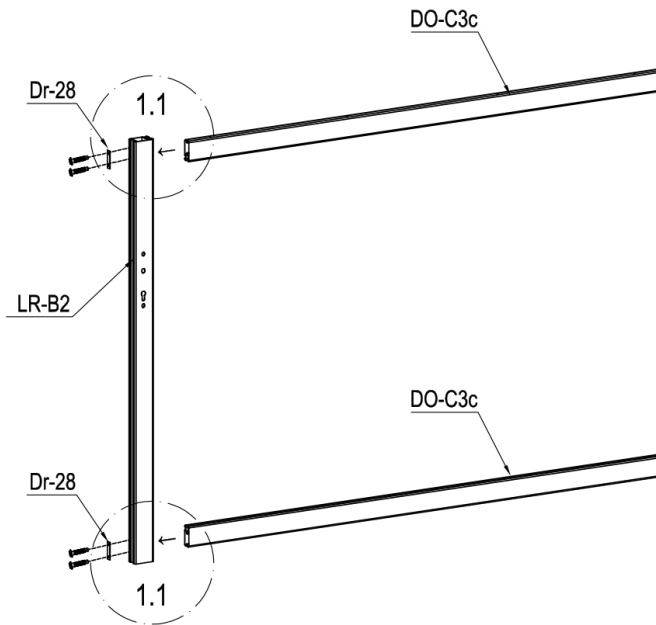



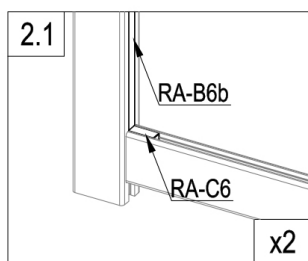
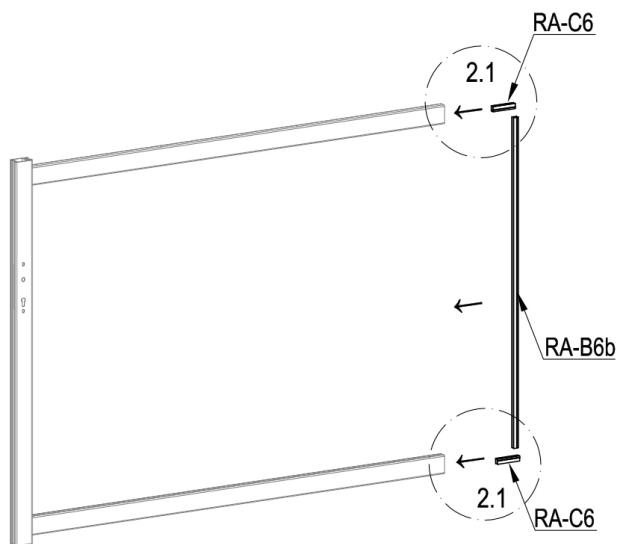

IMAGE	NO.	L.(mm)	QTY	IMAGE	NO.	L.(mm)	QTY
	LR-B1b	1573	2		Dr-14		1
	LR-B1c	1573	1		DO-30		4
	LR-B2	1573	1		AT-18	150	1
	AT-30	250	1		AT-18a	150	1
	AT-30a	250	1		ATL-14	1000	1
	DO-C3c	1957	4		ATL-14a	420	3
	RA-B4	1400	10		AT-19		4
	LR-E4a	1400	12		AT-20		4
	AT-A5b	1573	1		AT-21		1
	AT-C5	1448	1		AT-22		1
	AT-A5a	395.5	1		AT-23		2
	Dr-A5d	937	1		Dr-18		1
	AT-29	193	2		Dr-19		1
	Dr-A5d	52	1		Dr-20a		1
	AT-A11	1573	4		Dr-21		1
	AT-A11a	250	2		Dr-22		1
	DO-C11	1957	4		Dr-25		1
	AT-31	250	2		Dr-25a		2
	RA-A6a	38	40		Dr-27		2
	RA-B6b	1357	4		Dr-28		6
	RA-C6	100	8		AT-22J		7
	AT-A7b	1468	1		RA-CH30		4
	DO-D14	1823	2		RA-CH31		10
	DO-D14a	1823	2		RA-CH32		32
	DO-D16	1822	2		RA-CH33		4
	AT-16		1		RA-CH34		26
	AT-C17	1580	5		RA-CH35		70
	AT-17		2		RA-CH36		2
	AT-17a		2		RA-CH37		8
	AT-10		4		RA-CH38		50
	Dr-13		1				





	LR-B2	1
	DO-C3c	2
	Dr-28	2
	RA-CH33	4

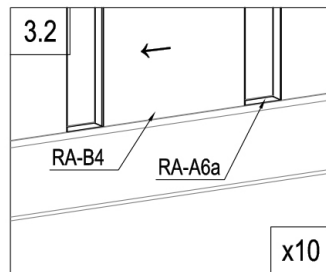
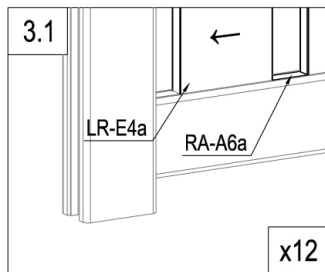
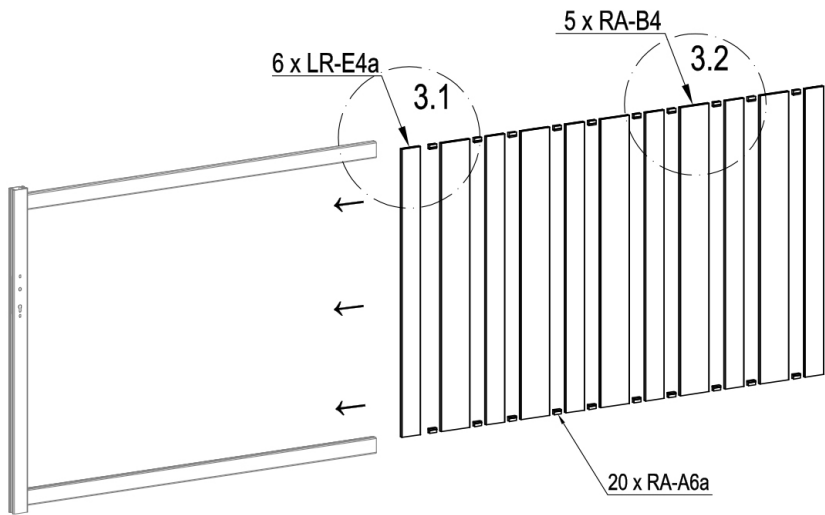

C	RA-C6	2
	RA-B6b	1





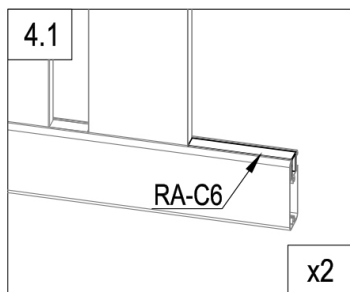
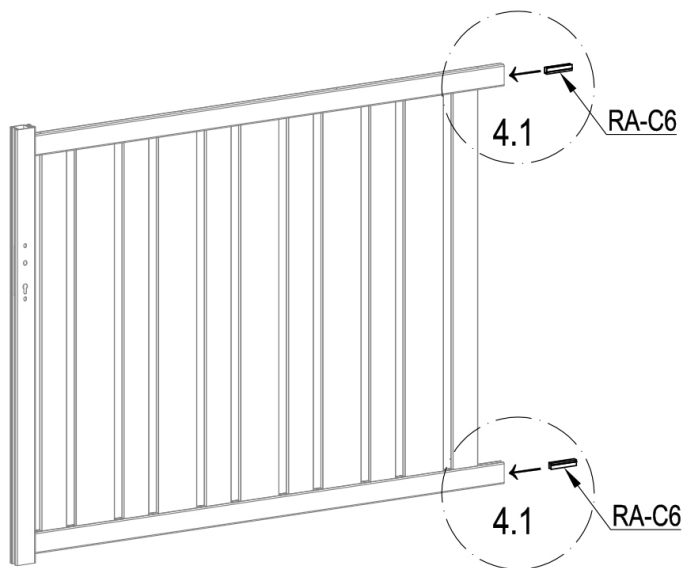

	RA-B4	5
	LR-E4a	6
	RA-A6a	20

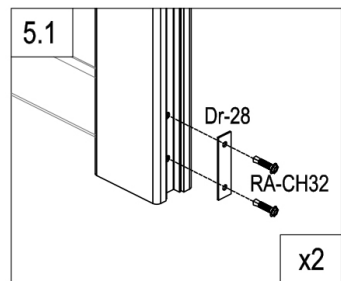
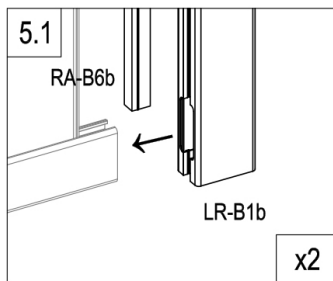
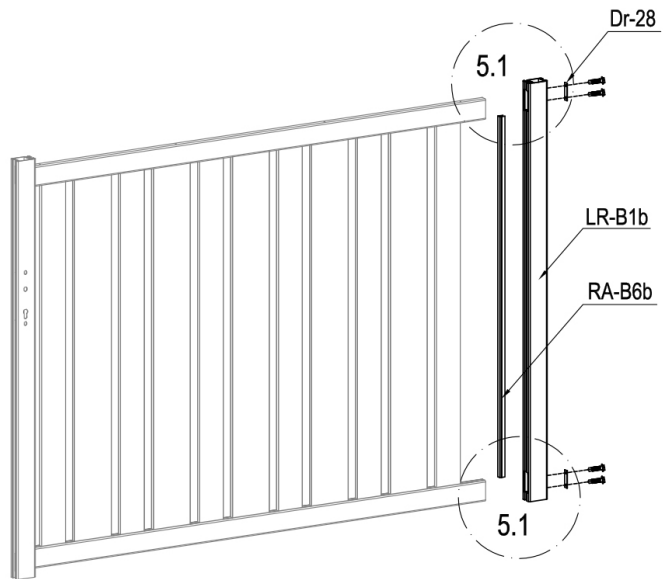



	RA-C6	2
---	-------	---

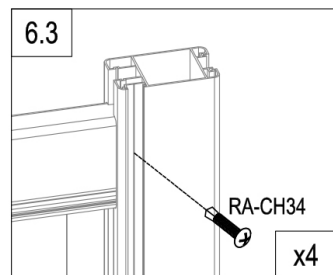
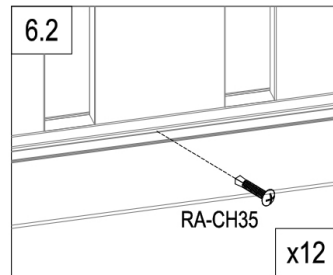
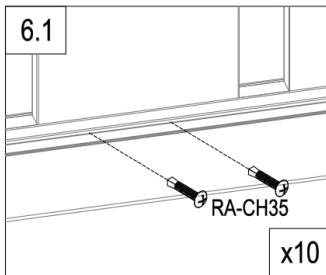
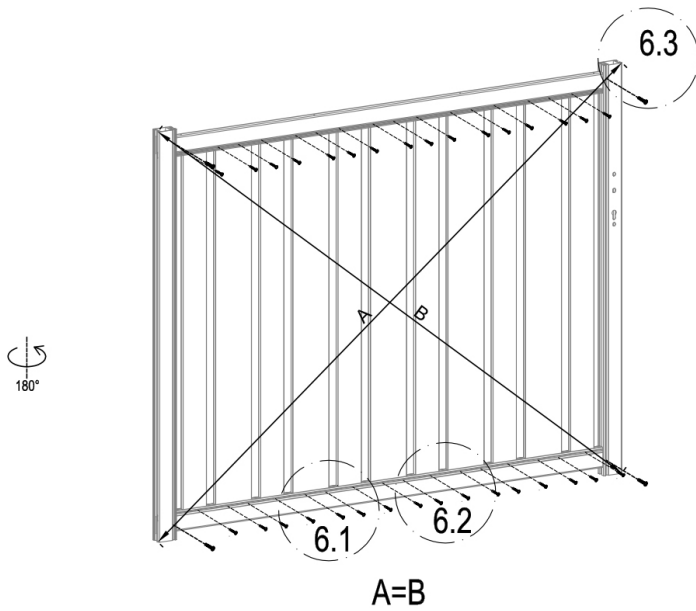

	LR-B1b	1
	RA-B6b	1
	Dr-28	2
	RA-CH32	4



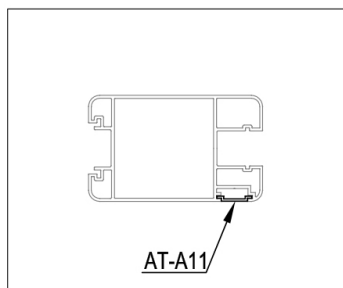
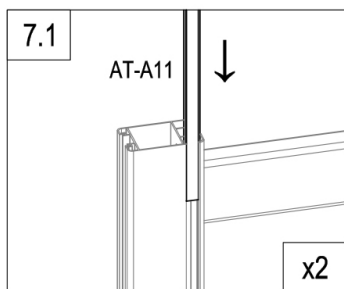
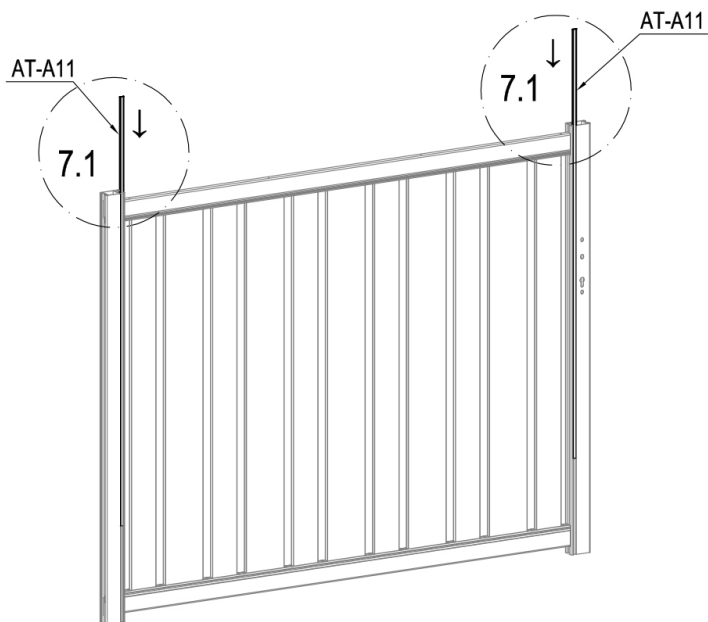

	RA-CH35	32
	RA-CH34	4

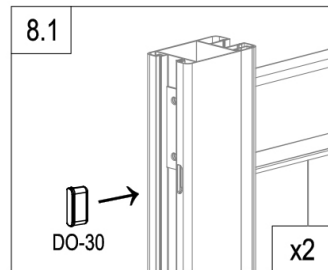
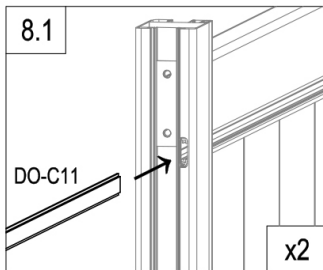
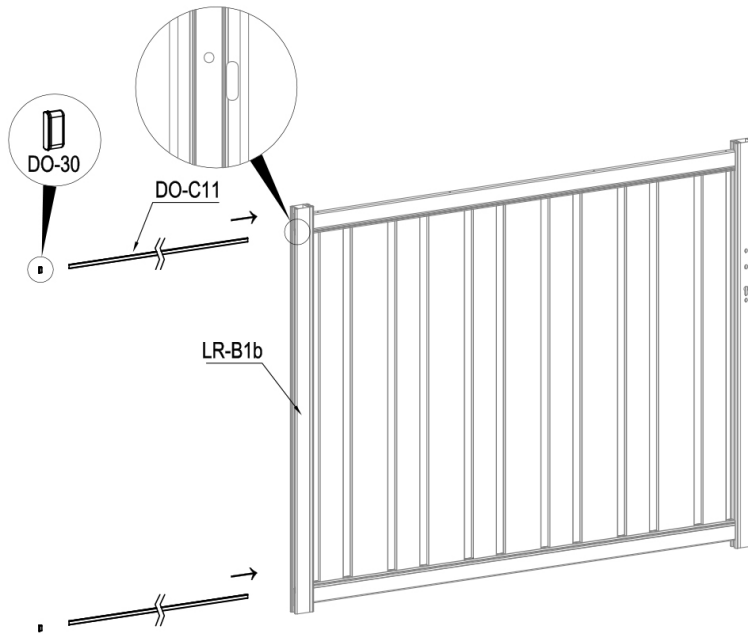

	AT-A11	2
---	--------	---



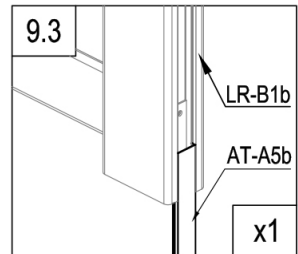
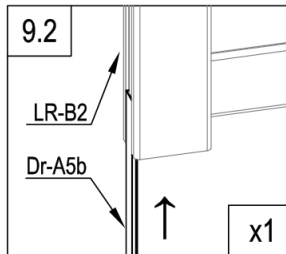
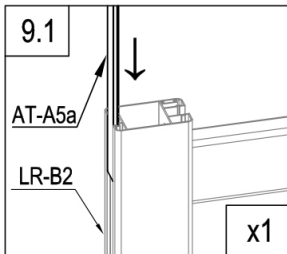
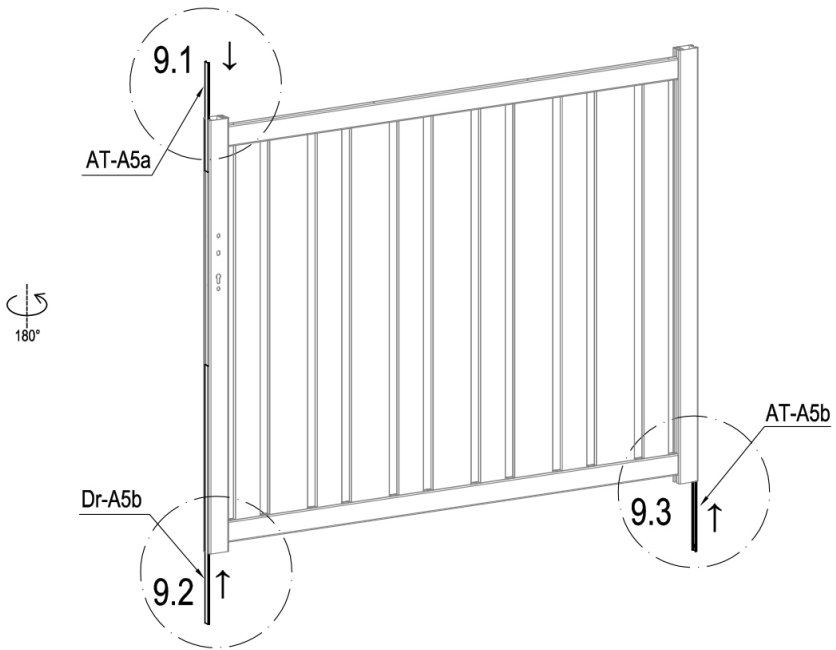

	DO-C11	2
	DO-30	2



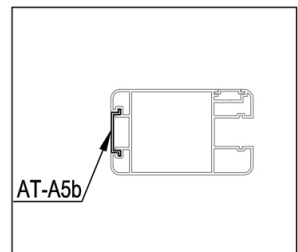

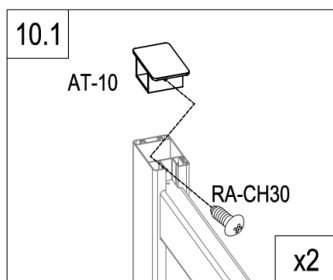
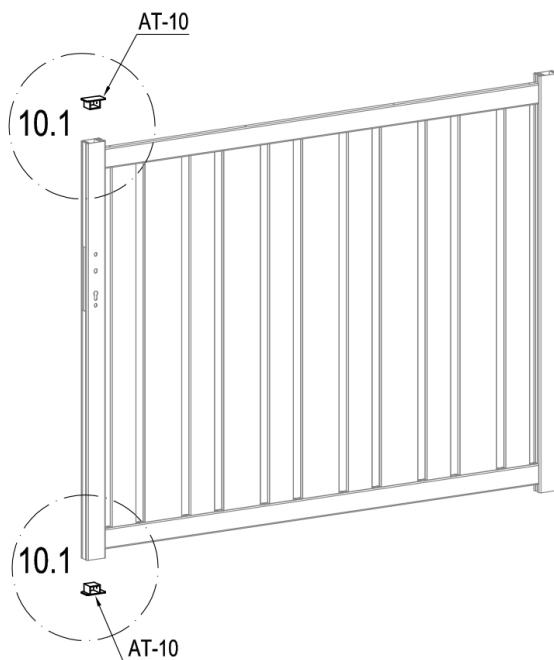

	AT-A5b	1
	AT-A5a	1
	Dr-A5b	1



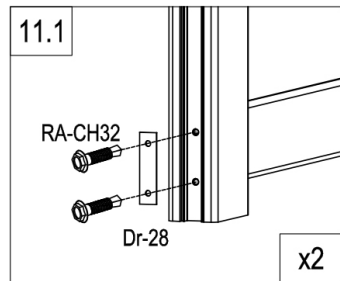
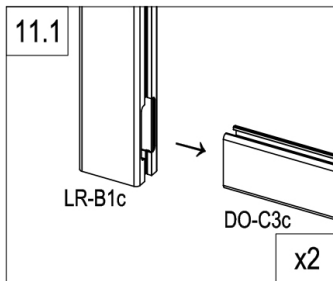
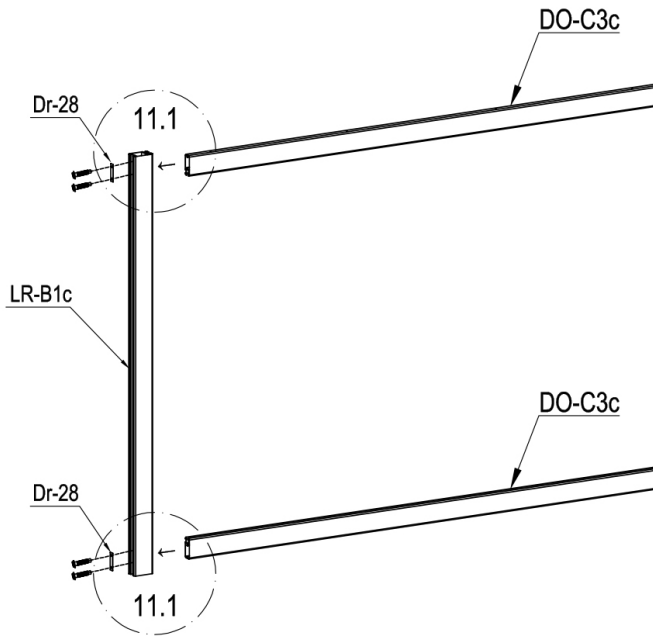

	AT-10	2
	RA-CH30	2



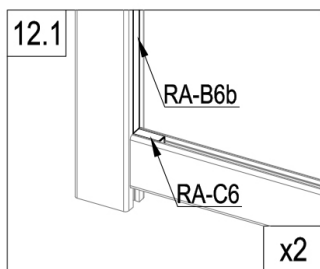
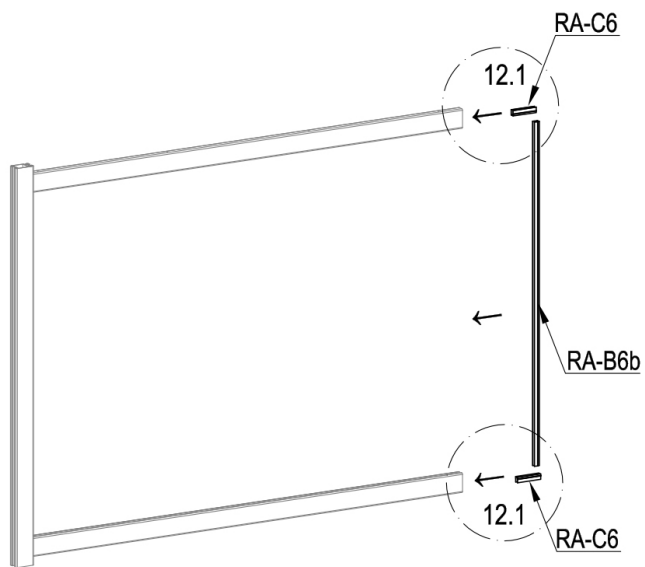

	LR-B1c	1
	DO-C3c	2
	Dr-28	2
	RA-CH32	4

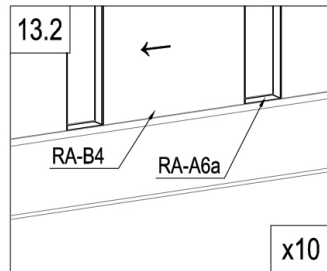
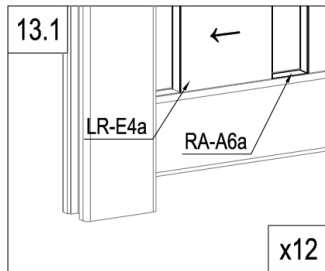
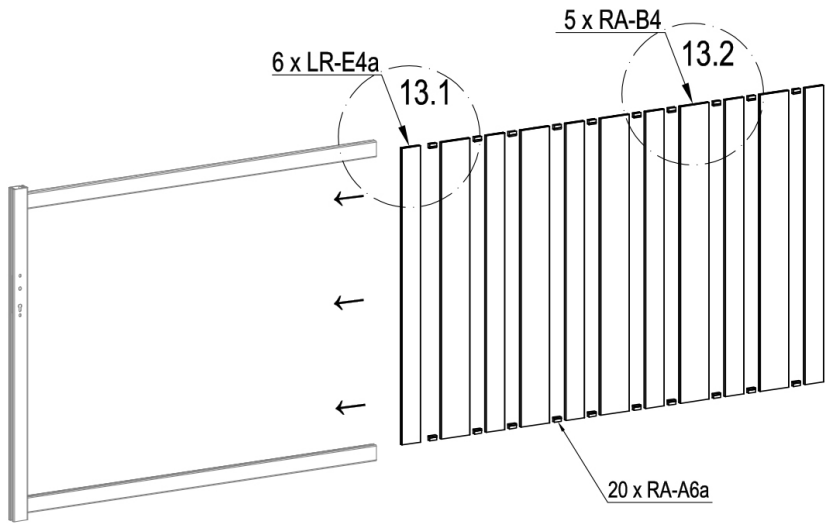

C	RA-C6	2
	RA-B6b	1



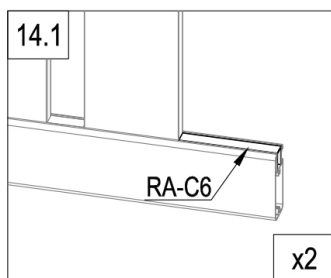
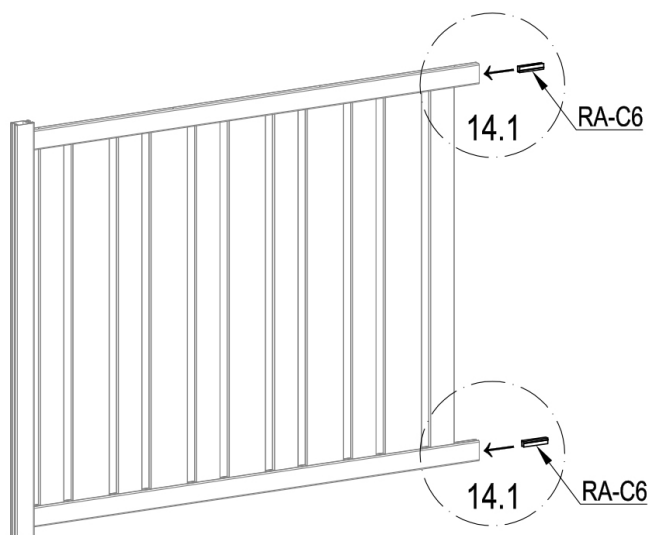

	RA-B4	5
	LR-E4a	6
	RA-A6a	20

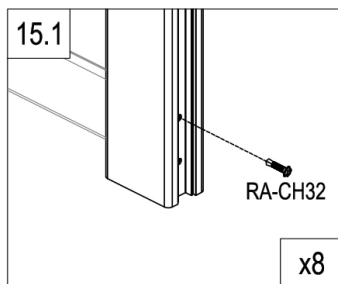
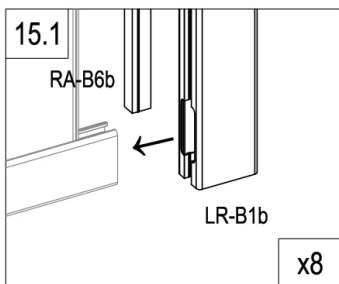
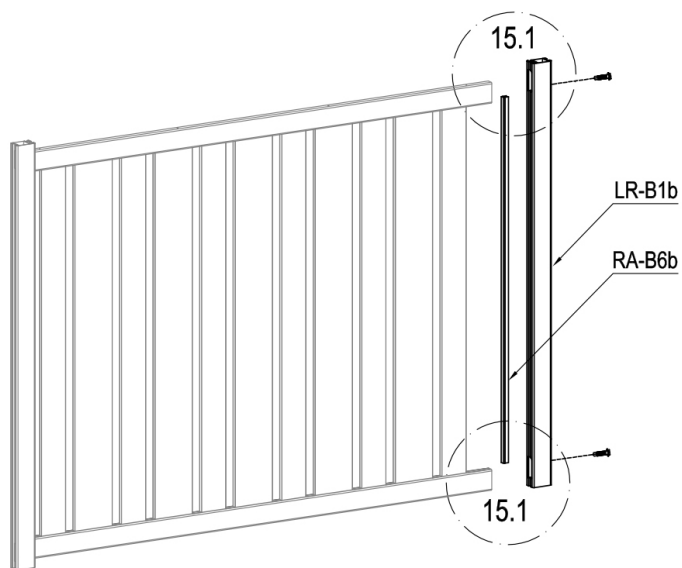

	RA-C6	2
---	-------	---



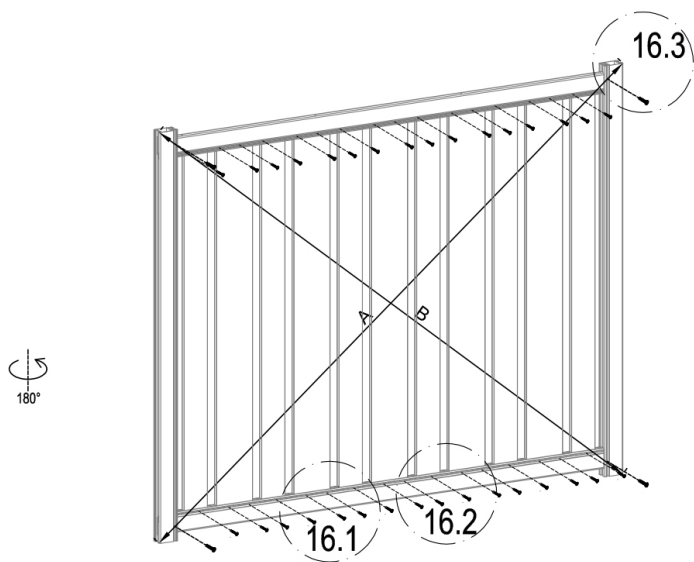

	LR-B1b	1
	RA-B6b	1
	RA-CH32	2

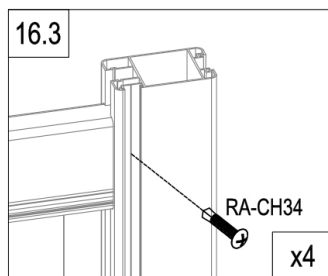
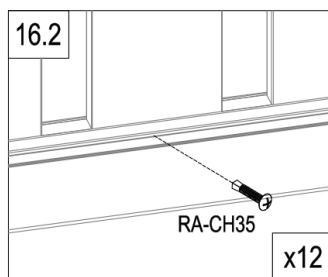
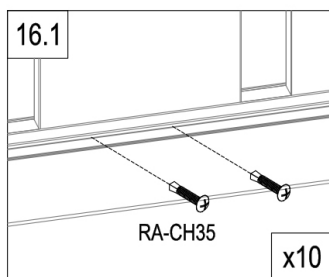

A=B



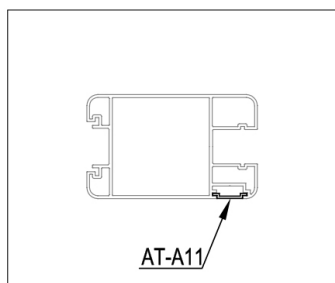
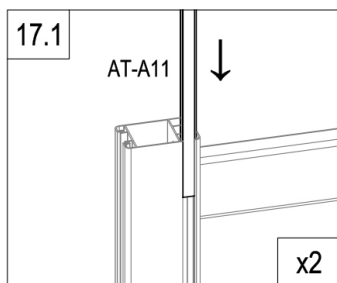
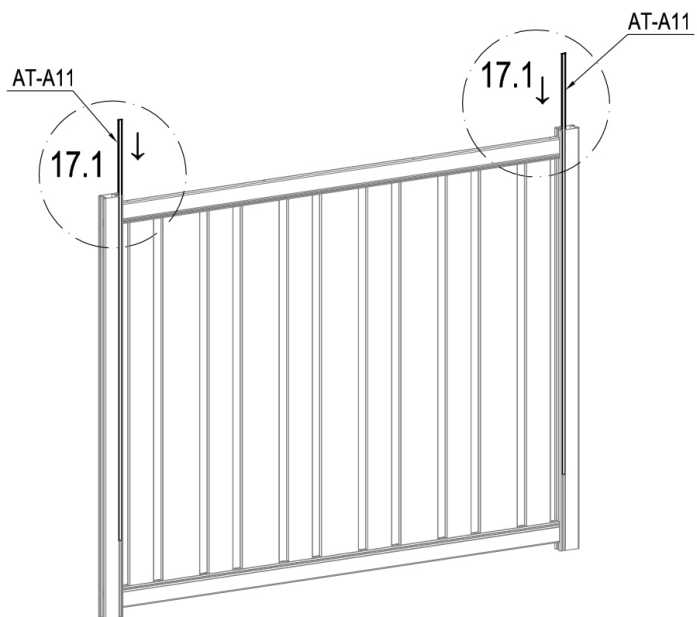

	RA-CH35	32
	RA-CH34	4



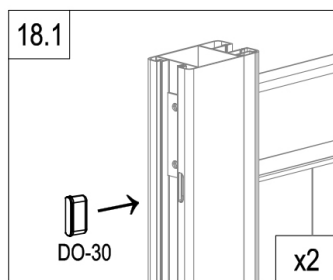
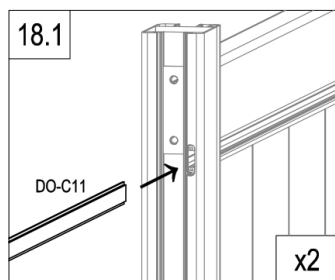
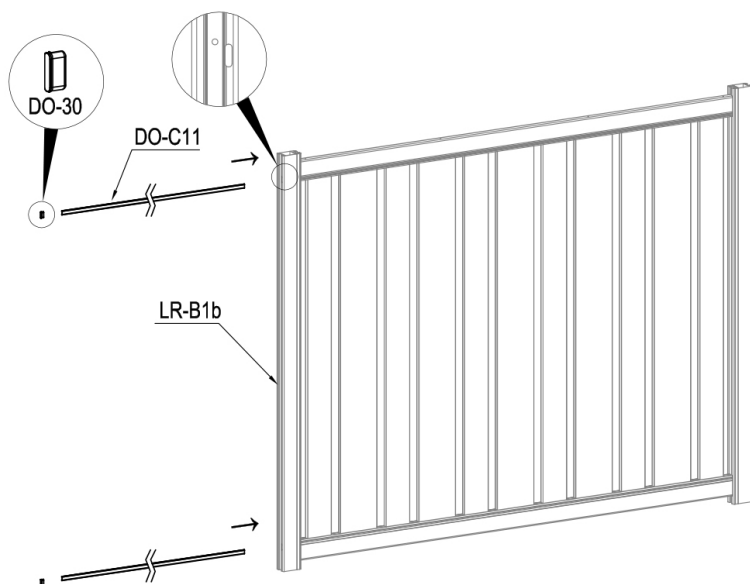



	AT-A11	2
---	--------	---

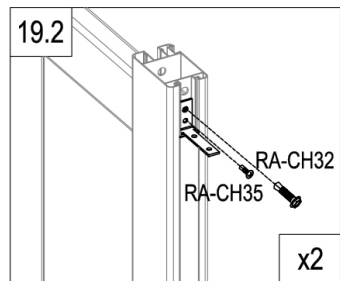
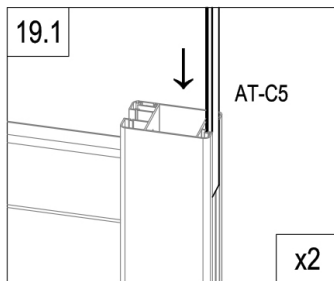
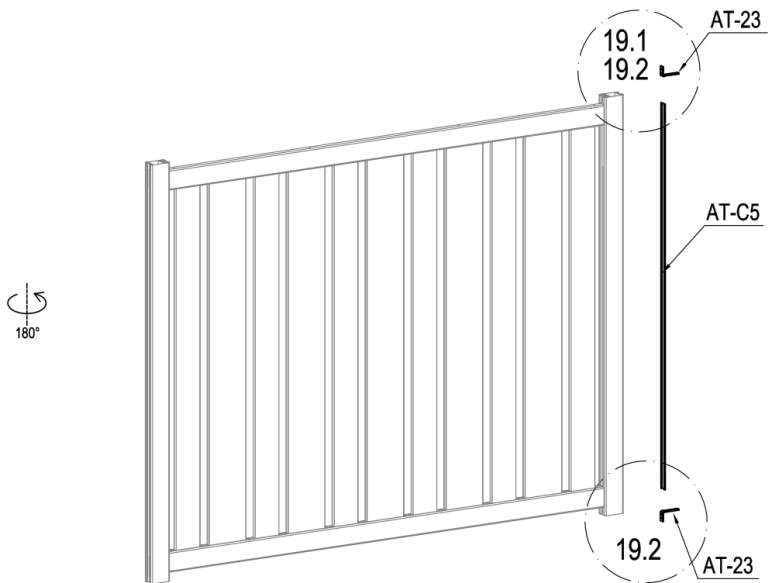





	DO-C11	2
	DO-30	2

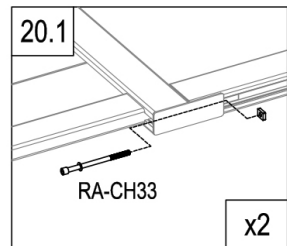
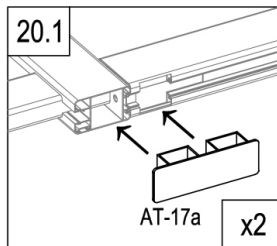
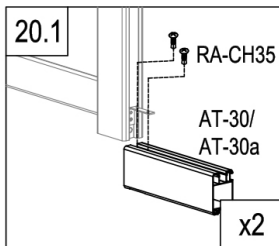
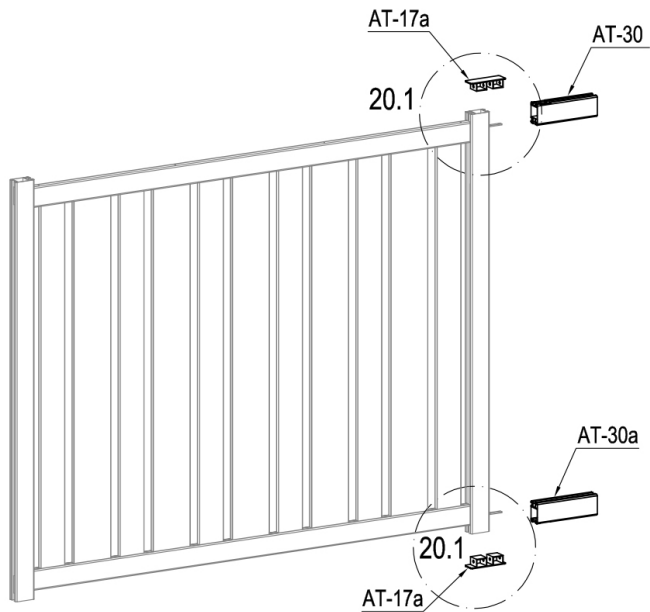

	AT-C5	1
	AT-23	2
	RA-CH32	2
	RA-CH35	2



	AT-30	1
	AT-30a	1
	AT-17a	2

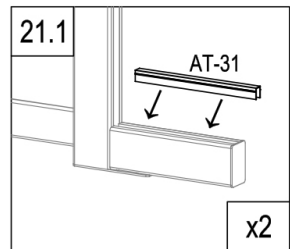
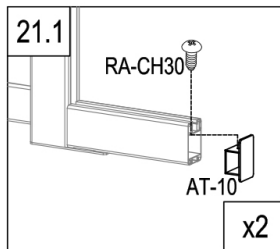
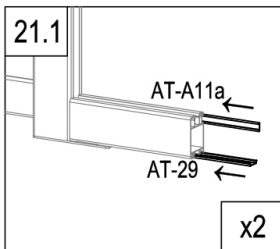
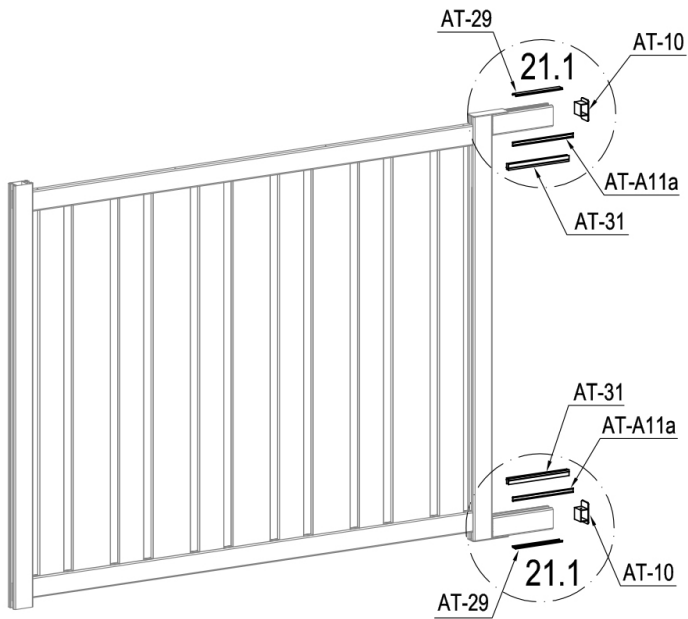

	RA-CH33	2
	RA-CH35	4



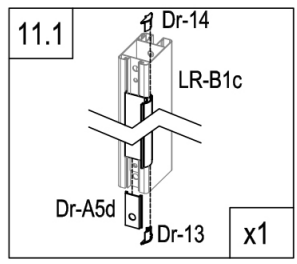
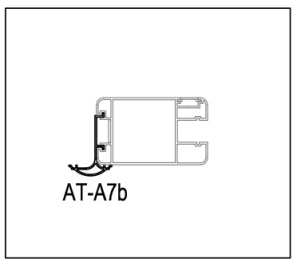
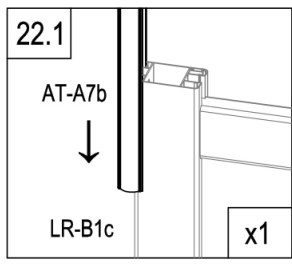
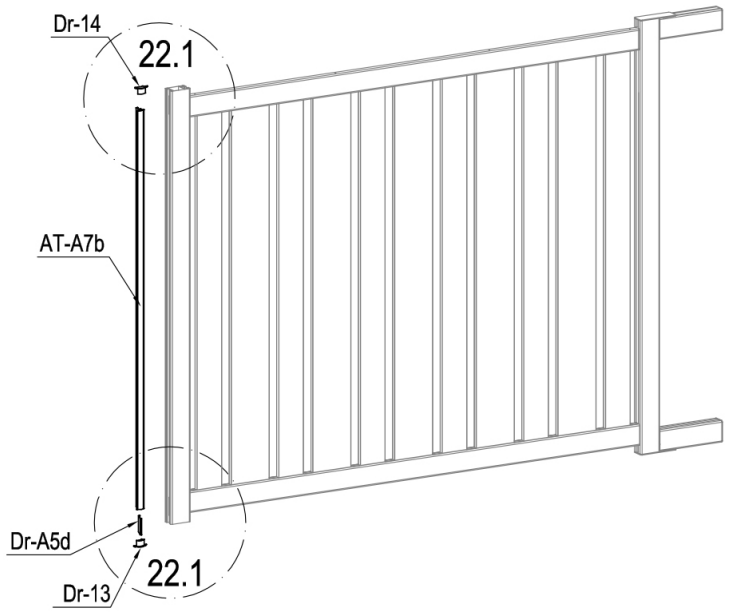

	AT-29	2
	AT-A11a	2
	AT-31	2

	AT-10	2
	RA-CH30	2

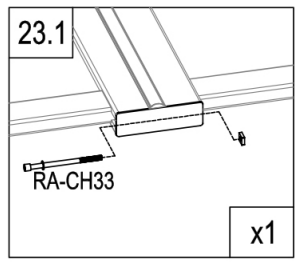
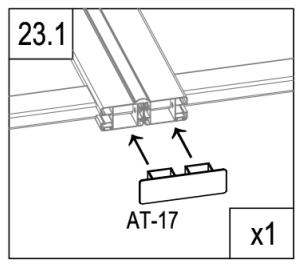
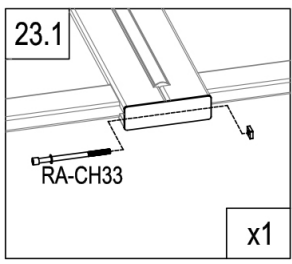
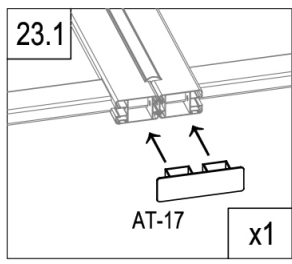
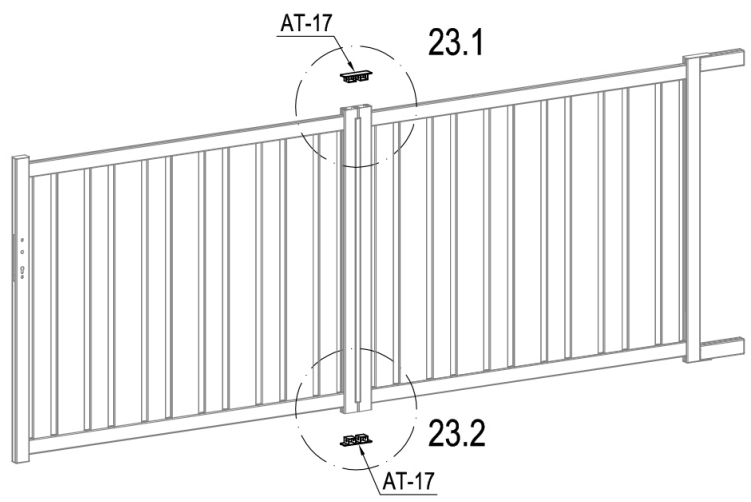

	AT-A7a	1
	Dr-13	1
	Dr-14	1



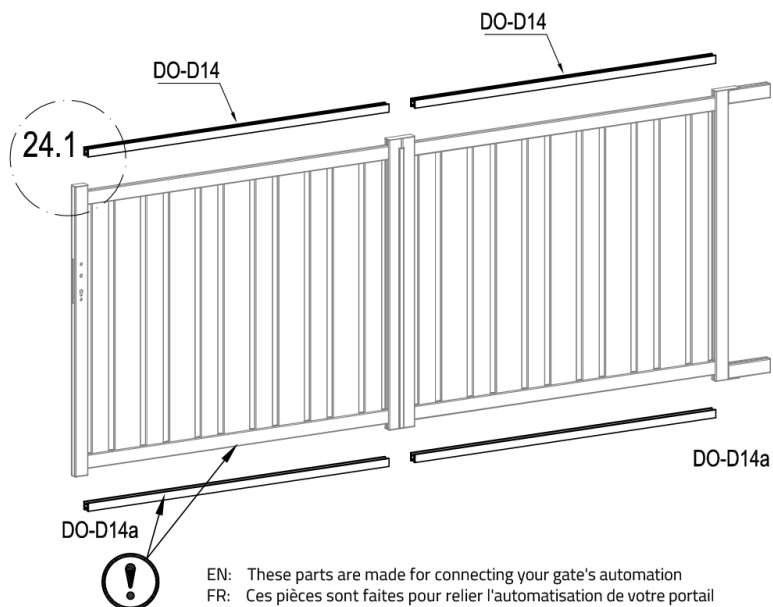

	AT-17	2
	RA-CH33	2



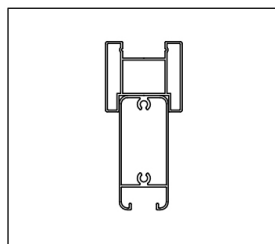
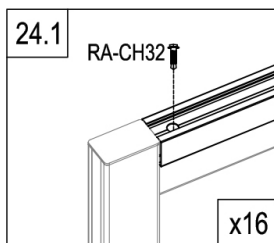
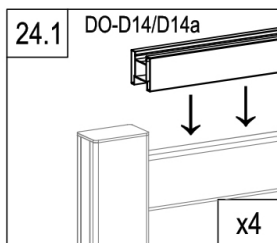

EN: These parts are made for connecting your gate's automation
 FR: Ces pièces sont faites pour relier l'automatisation de votre portail
 DE: Diese Teile sind für den Anschluss der Automatisierung Ihres Tores vorgesehen
 ES: Estas piezas están hechas para conectar la automatización de su puerta
 PT: Estas peças são feitas para ligar a automatização do seu portão
 IT: Queste parti sono realizzate per collegare l'automazione del vostro cancello
 NL: Deze onderdelen zijn gemaakt voor het aansluiten van de automatisering van uw poort.
 PL: Te części są wykonane do podłączenia automatyki bramy.



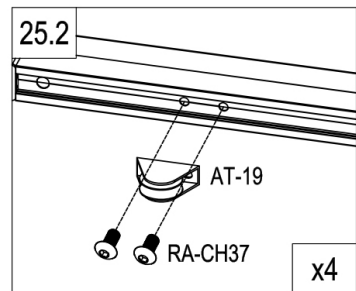
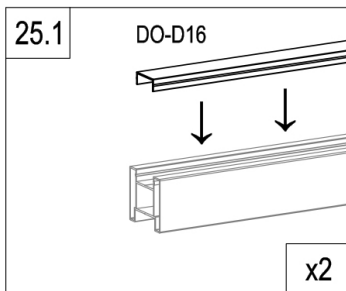
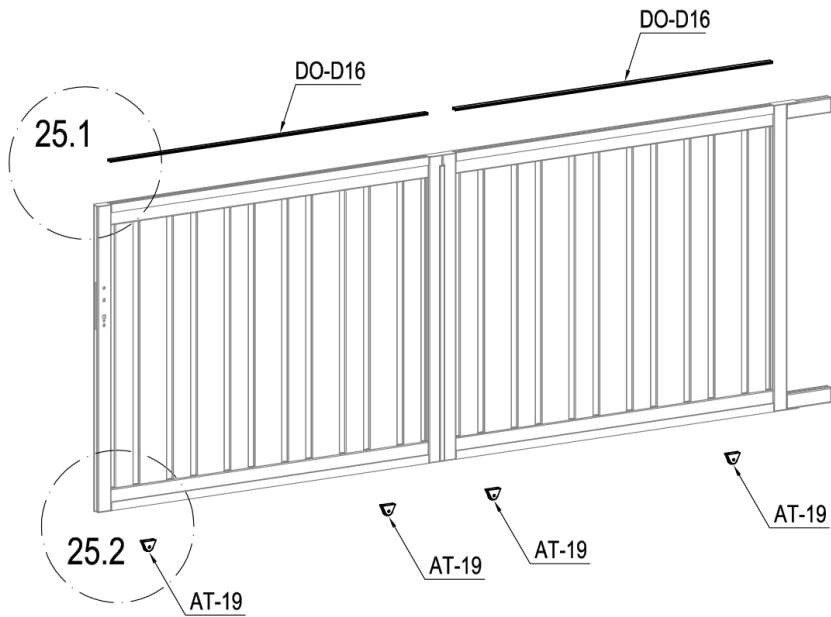

	DO-D14	2
	DO-D14a	2
	RA-CH32	16

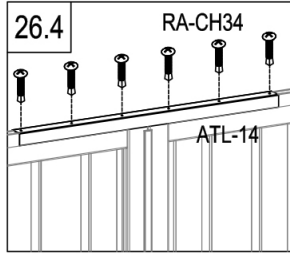
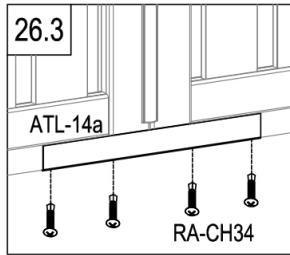
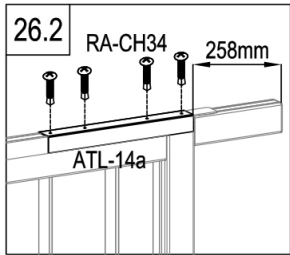
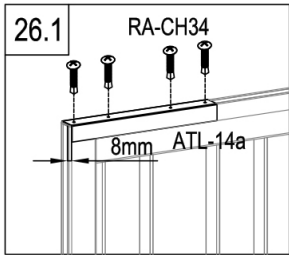
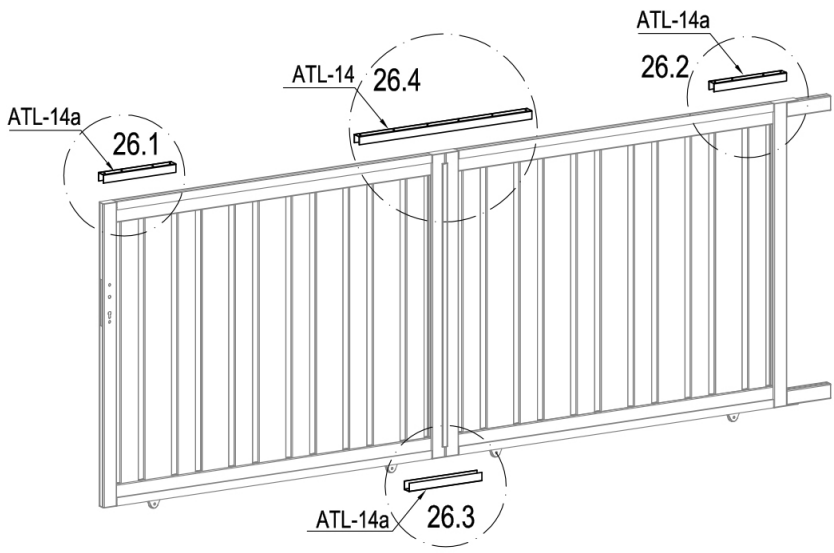

	DO-D16	2
	AT-19	4
	RA-CH37	8



	ATL-14	1
	ATL-14a	1
	RA-CH34	18

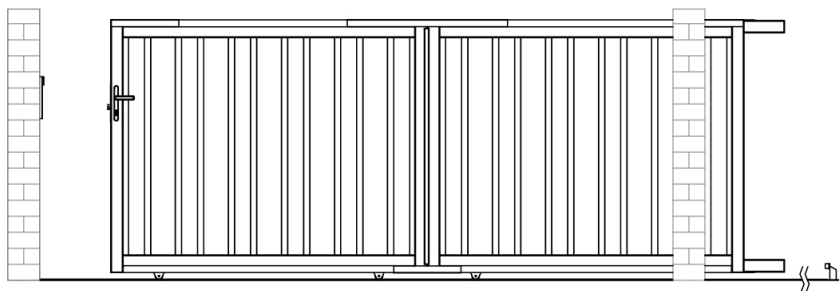

L

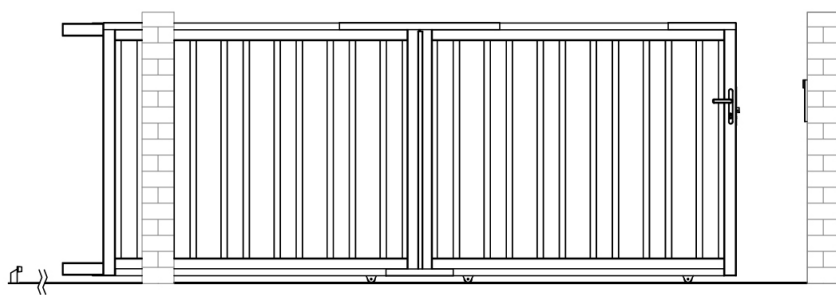

R

L

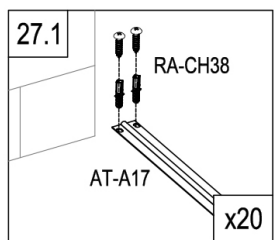
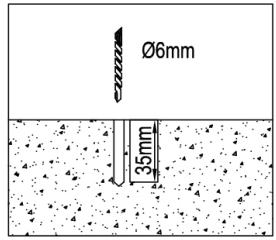
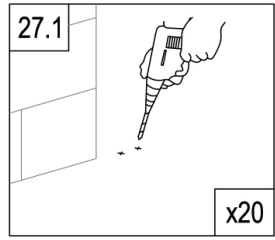
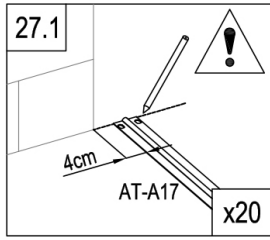
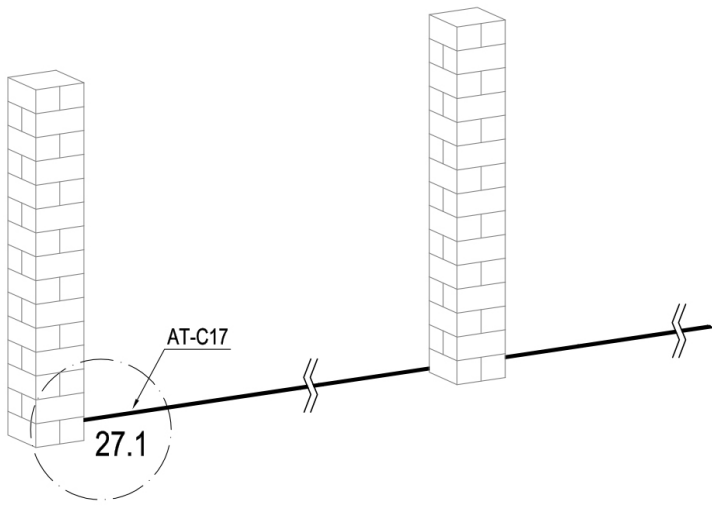

	AT-A17	5
	RA-CH38	40

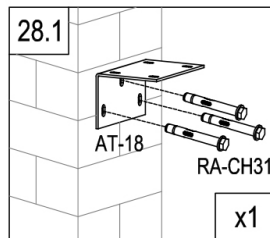
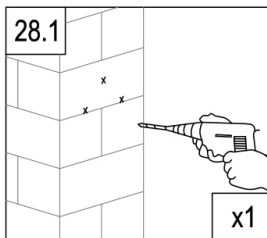
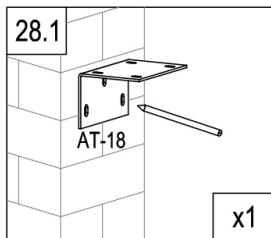
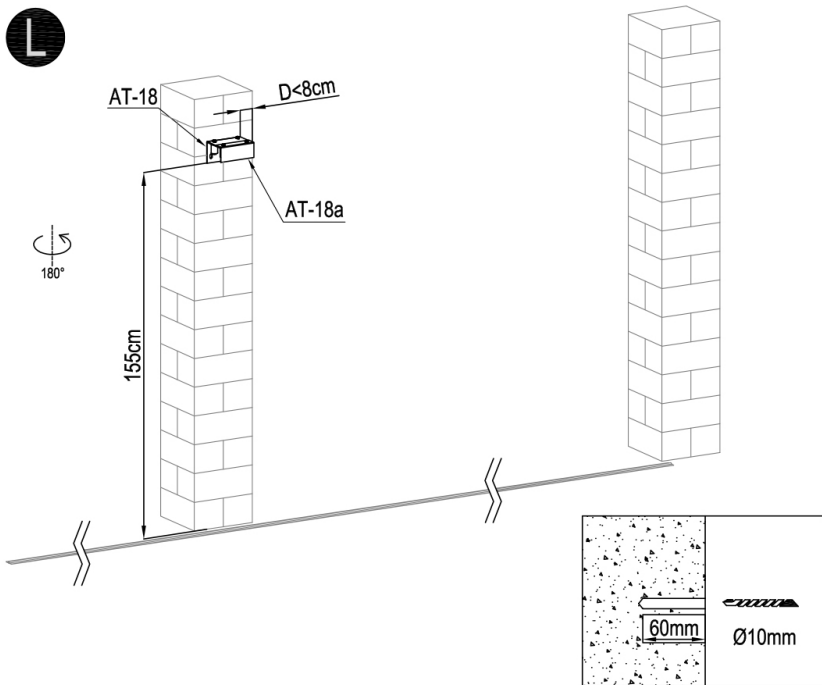

	AT-18	1
	AT-18a	1
	AT-20	4
	RA-CH31	3

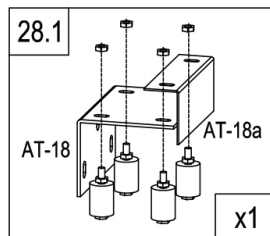
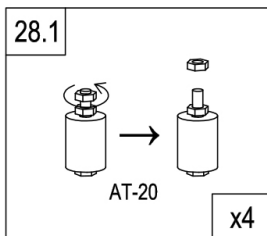

L

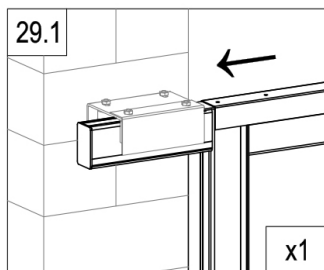
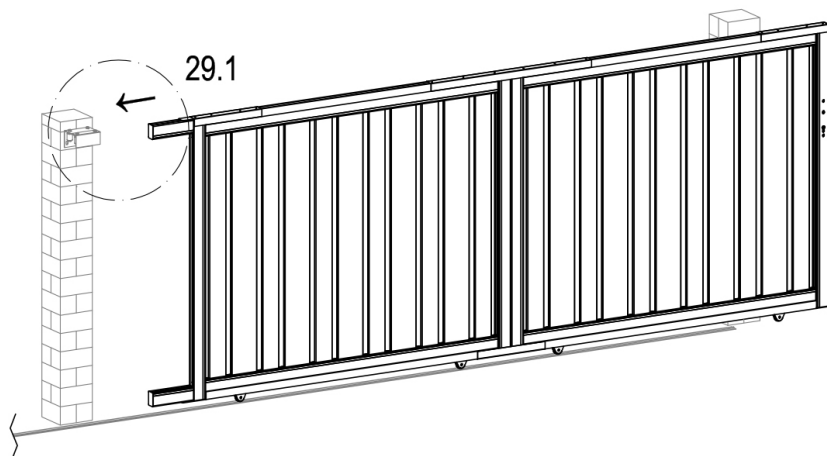

L

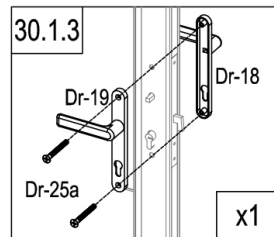
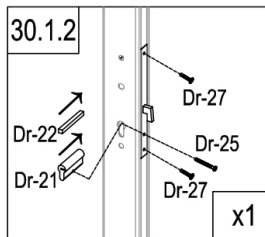
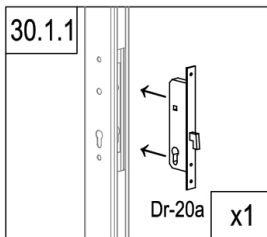
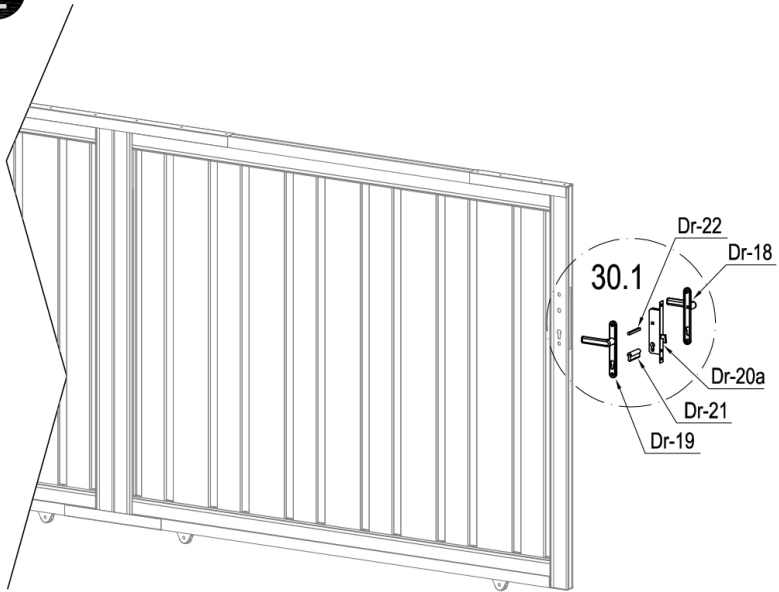

	Dr-20a	1
	Dr-21	1
	Dr-22	1
	Dr-25	1

	Dr-18	1
	Dr-19	1
	Dr-25a	2
	Dr-27	2

L

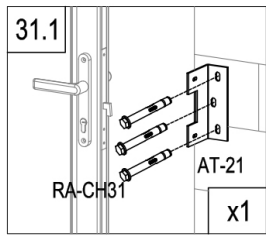
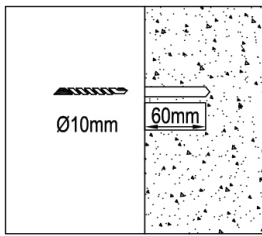
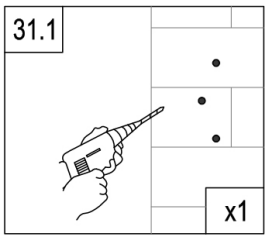
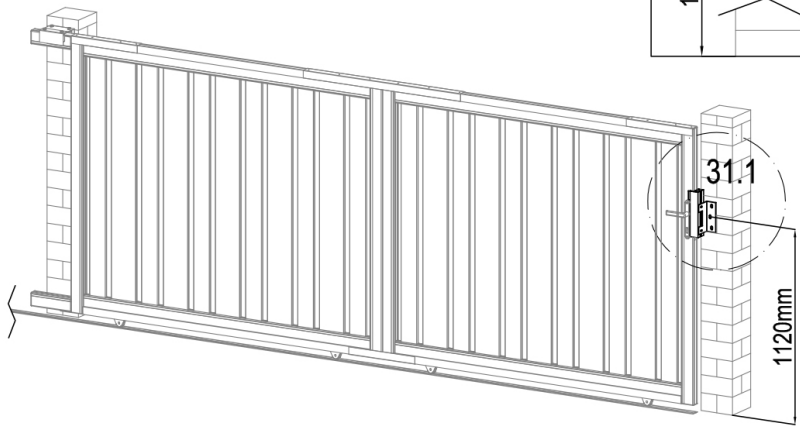
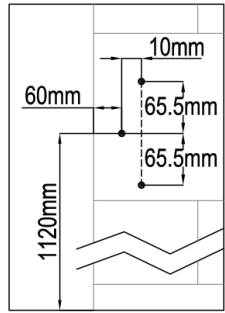

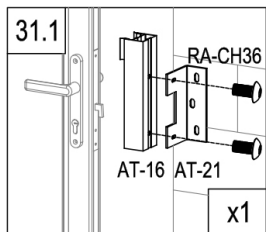
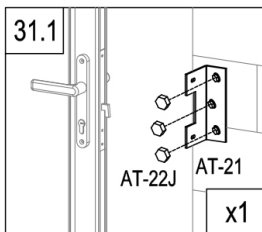

	AT-16	1
	AT-21	1
	RA-CH36	2
	RA-CH31	3
	AT-22J	3

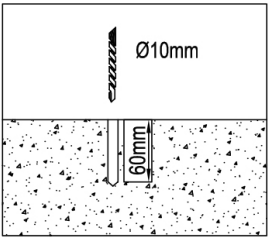
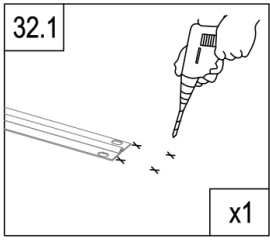
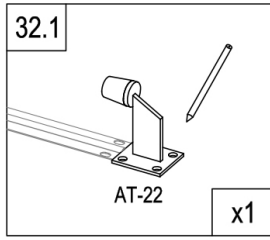
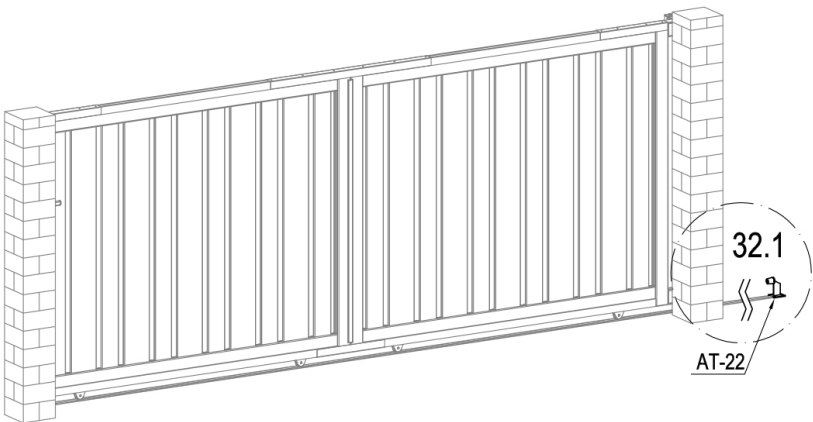

L



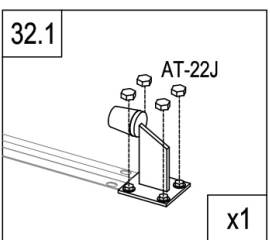
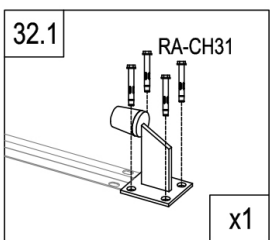

	AT-22	1
	RA-CH31	4
	AT-22J	4

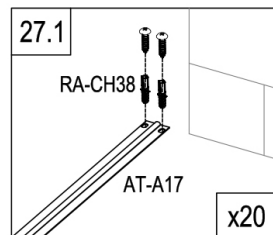
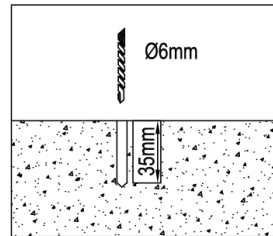
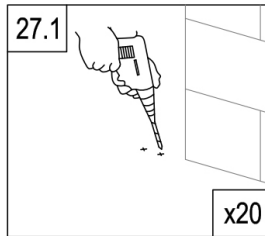
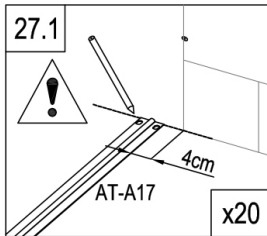
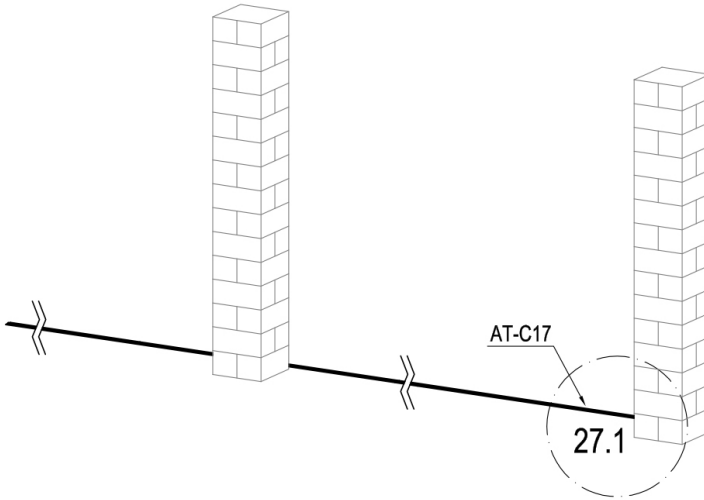

R



	AT-A17	5
	RA-CH38	40

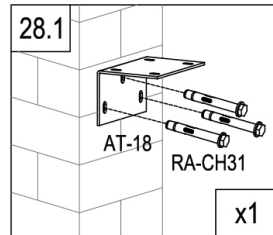
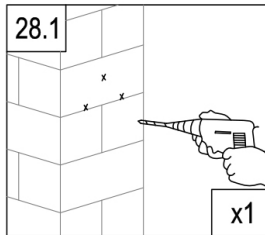
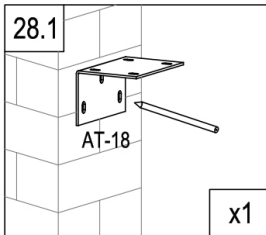
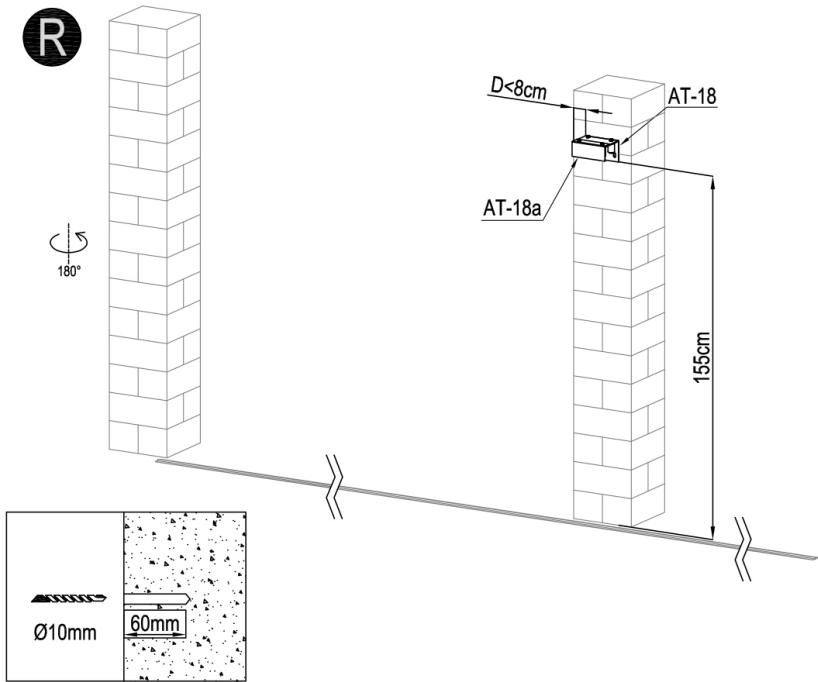

	AT-18	1
	AT-18a	1
	AT-20	4
	RA-CH31	3

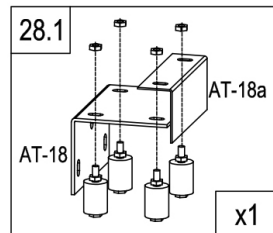
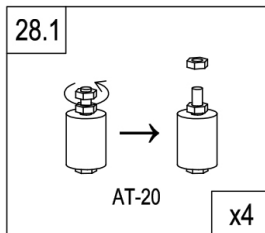

R

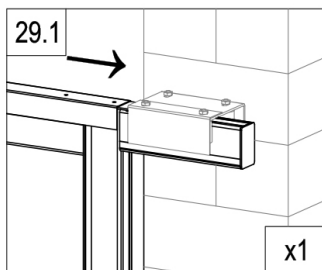
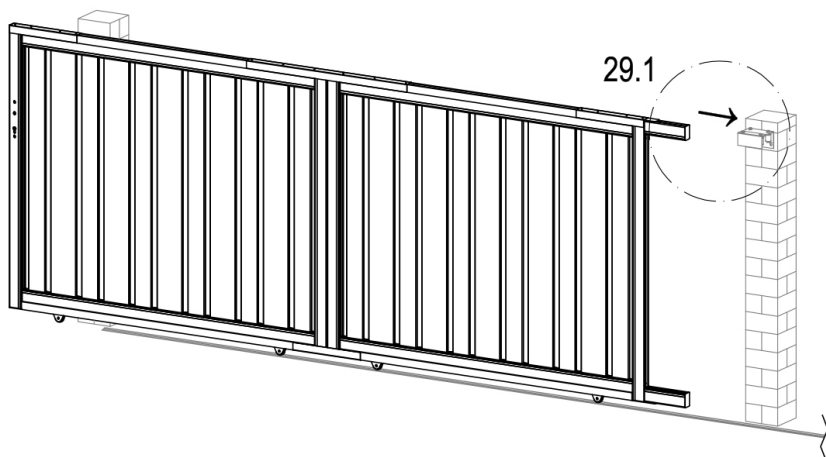

R

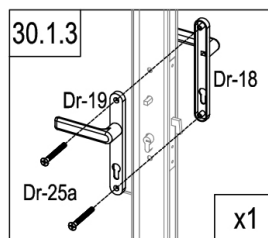
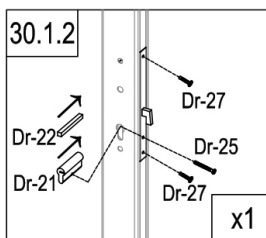
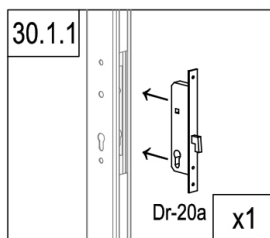
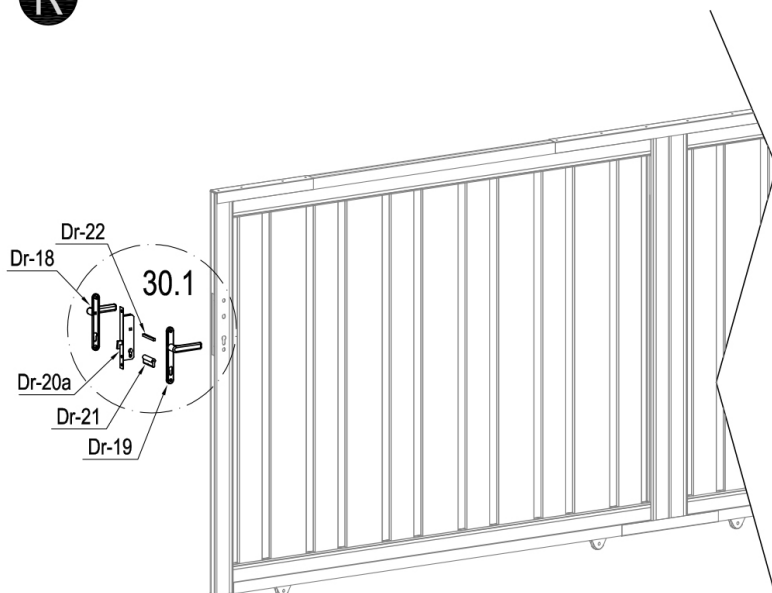

	Dr-20a	1
	Dr-21	1
	Dr-22	1
	Dr-25	1

	Dr-18	1
	Dr-19	1
	Dr-25a	2
	Dr-27	2

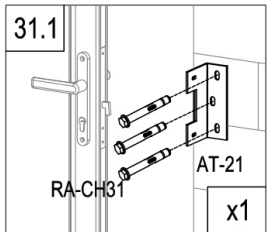
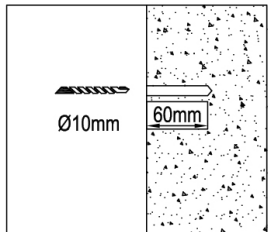
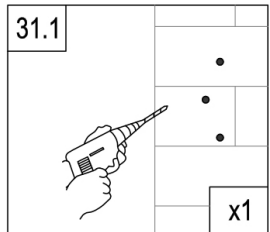
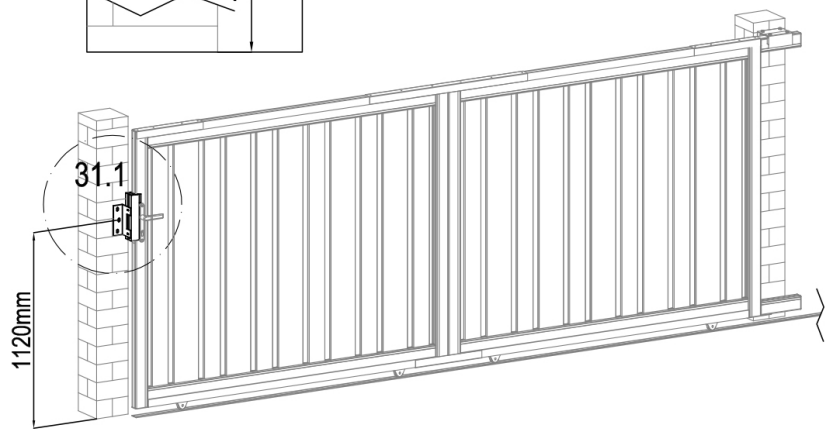
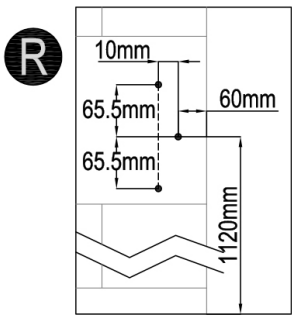

	AT-16	1
	AT-21	1
	RA-CH36	2
	RA-CH31	3
	AT-22J	3

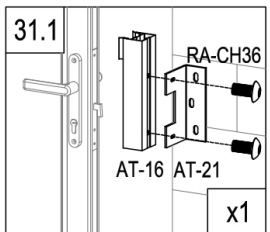
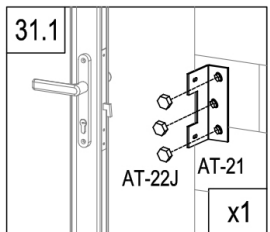

R

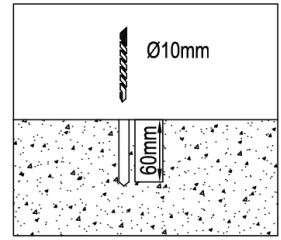
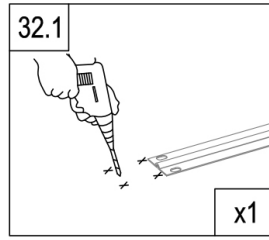
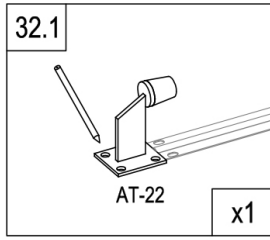
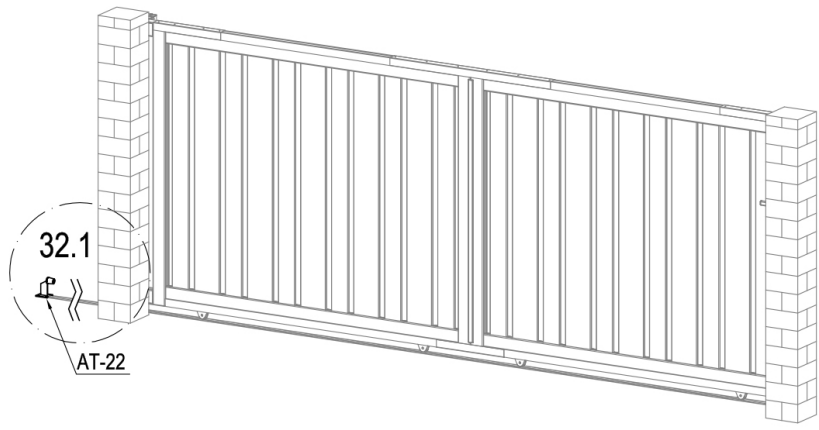

	AT-22	1
	RA-CH31	4
	AT-22J	4

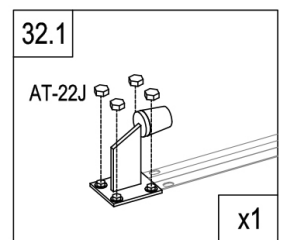
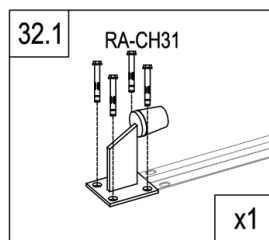

CASANOVA

