

CASANOVO

VOGEL 400C140

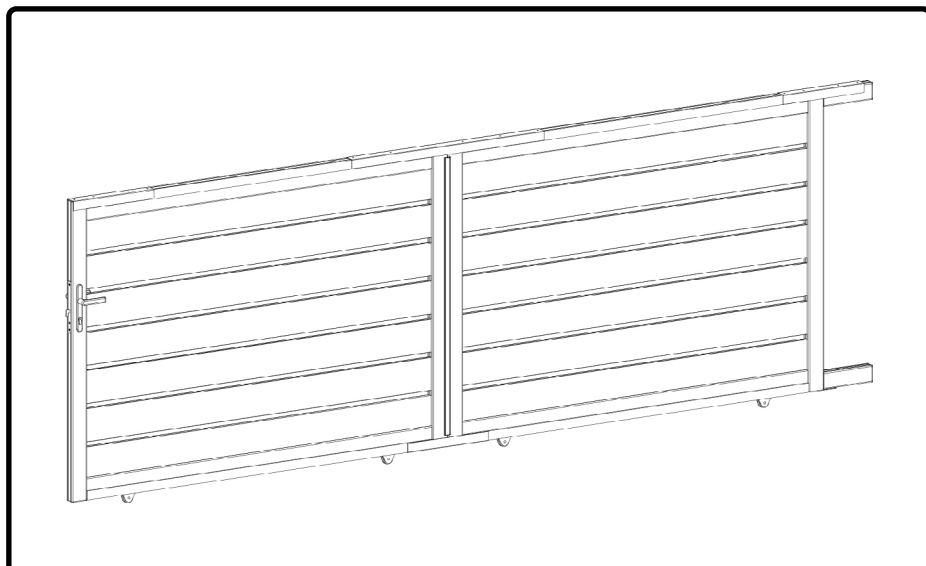

COM-000031 [x1]

COM-000033 [x1]

COM-000032 [x1]



INSTRUCTION MANUAL / NOTICE DE MONTAGE / MONTAGEANLEITUNG / MANUAL DE MONTAJE / MANUAL DE MONTAGEM / MANUALE DI MONTAGGIO /
MONTAGEHANDLEIDING / INSTRUKCJA MONTAŻU / KÄYTTÖOHJEET / BRUKSANVISNING / BRUGSANVISNING / INSTRUCIUNI DE ASAMBLARE /
NAVODILA ZA SESTAVLJANJE / NÁVOD NA MONTÁŽ / ÖSSZESZERELÉSI ÚTMUTATÓ / NÁVOD K MONTÁŽI / UPUTE ZA INSTALACIJU /
ΟΔΗΓΙΕΣ ΣΥΝΑΡΜΟΛΟΓΗΣΗΣ / SURINKIMO INSTRUKCIJOS / MONTĀŽAS INSTRUKCIJAS

Ext.

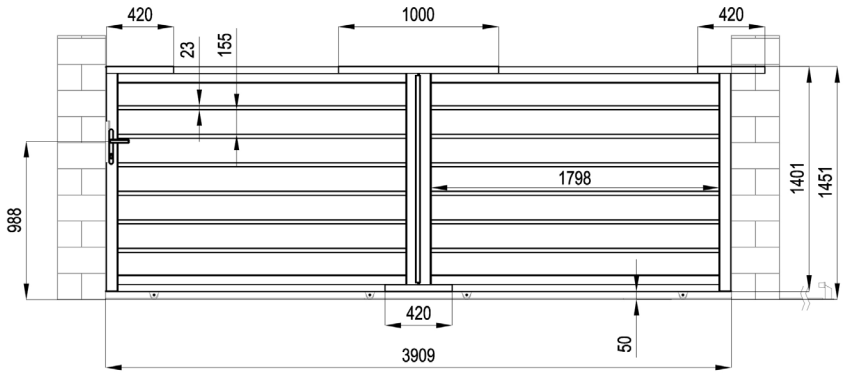



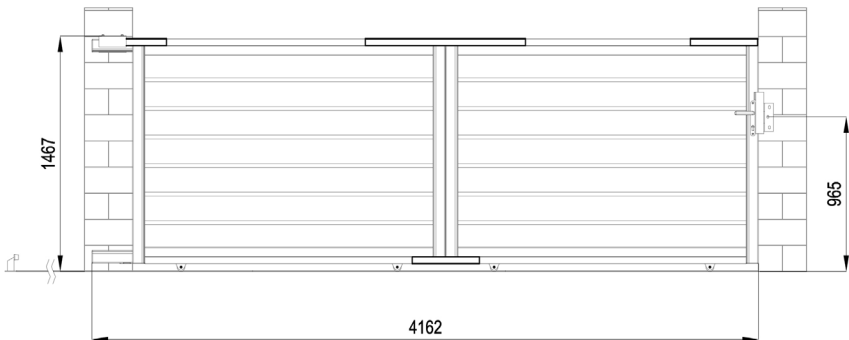

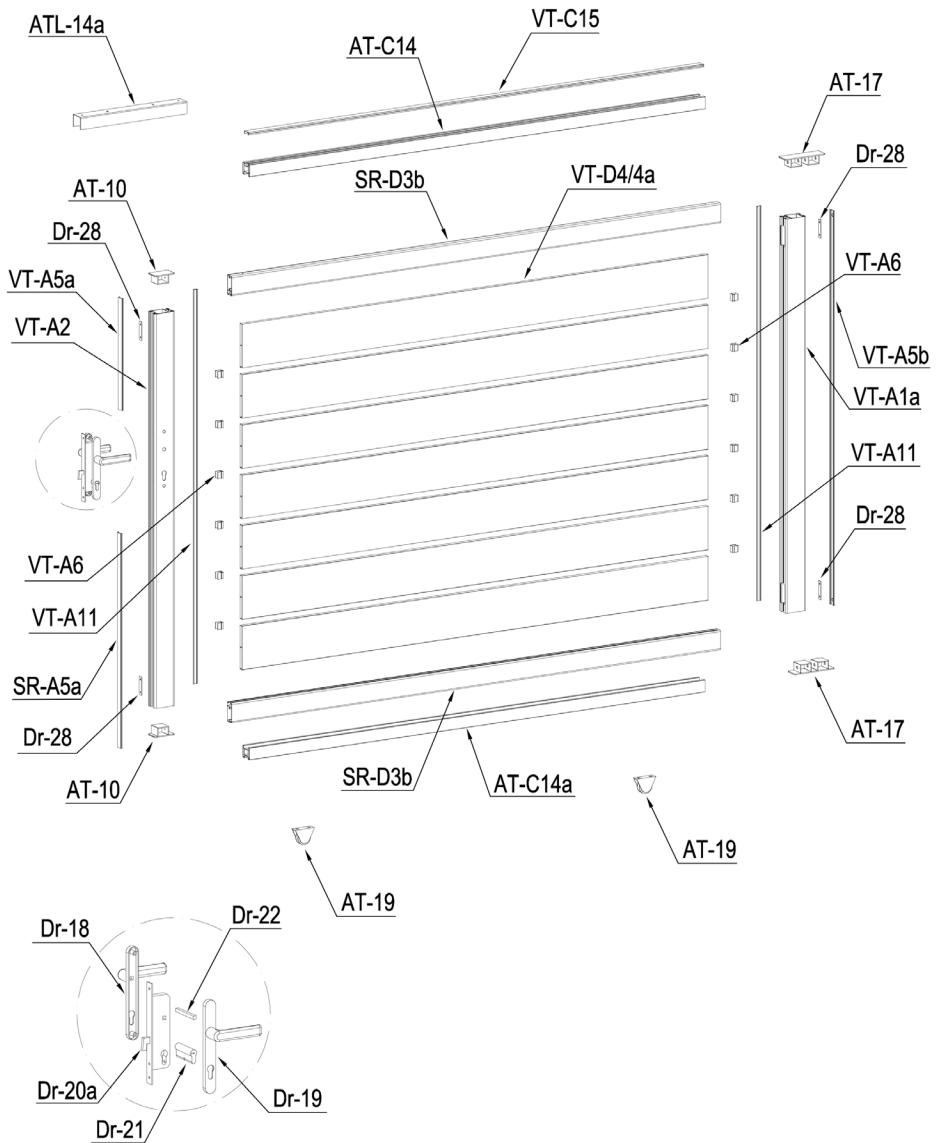

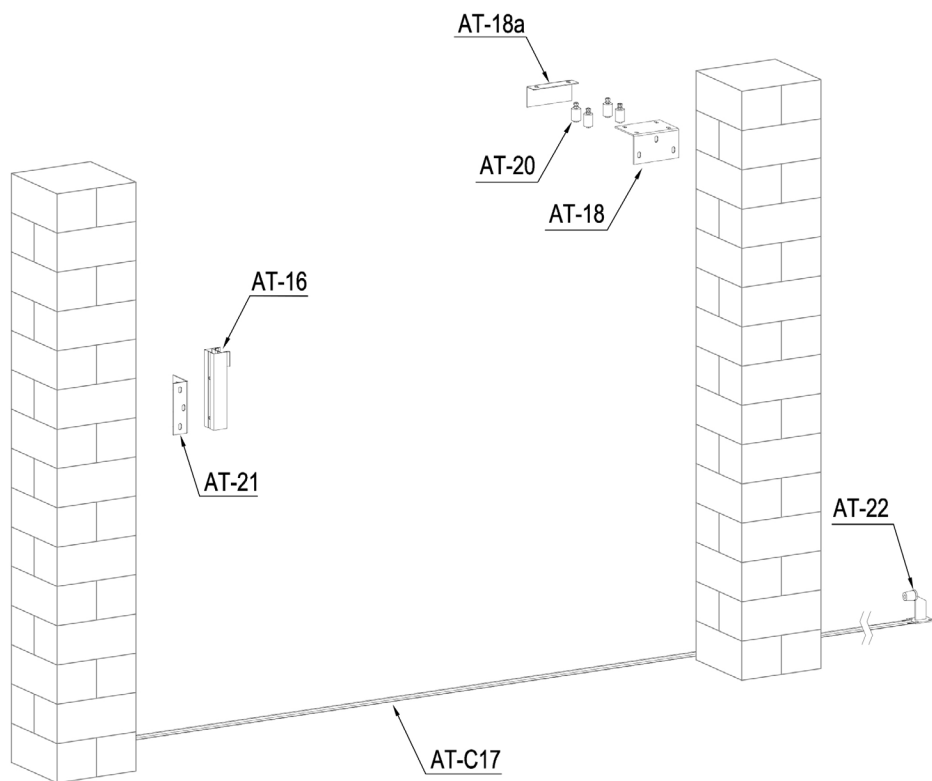





































Int.









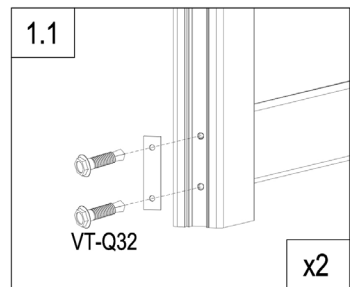
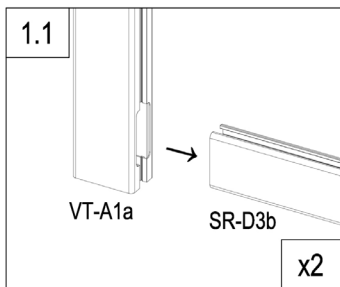
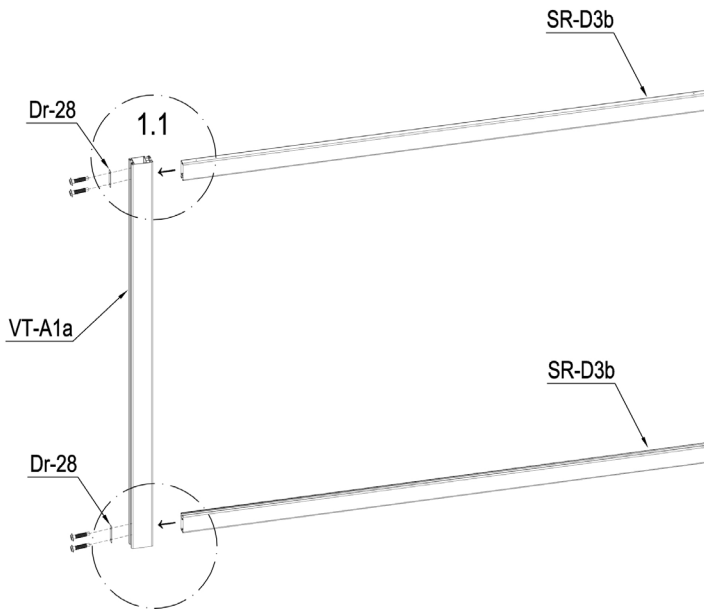

PART LIST

IMAGE	NO.	L.(mm)	QTY	IMAGE	NO.	L.(mm)	QTY
	VT-A1a	1395	3		ATL-14	1000	1
	VT-A2	1395	1		ATL-14a	420	3
	AT-30	250	1		Dr-18		1
	AT-30a	250	1		Dr-19		1
	SR-D3b	1931	4		Dr-20a		1
	VT-D4	1840	12		Dr-21		1
	VT-D4a	1840	2		Dr-22		1
	VT-C5	1270	1		Dr-25		1
	VT-A5a	372.5	1		Dr-25a		2
	SR-A5a	782	1		Dr-27		2
	VT-A5b	1395	1		AT-18		1
	AT-29	193	2		AT-18a		1
	Dr-A5d	52	1		AT-19		4
	VT-A11	1395	4		AT-20		4
	AT-A11a	250	2		AT-21		1
	VT-A6	23	24		AT-22		1
	AT-31	250	2		AT-23		2
	VT-A7b	1290	1		VT-Q30		4
	AT-C14	1798	2		VT-Q31		10
	AT-C14a	1798	2		VT-Q32		32
	VT-C15	1797	2		VT-Q33		4
	AT-16	260	1		VT-Q34		75
	AT-C17	1580	5		VT-Q35		6
	AT-17		2		VT-Q36		2
	AT-17a		2		VT-Q37		8
	AT-10		4		VT-Q38		50
	Dr-13		1		Dr-28		6
	Dr-14		1		AT-22J		7



	VT-A1a	1
	SR-D3b	2
	Dr-28	2
	VT-Q32	4

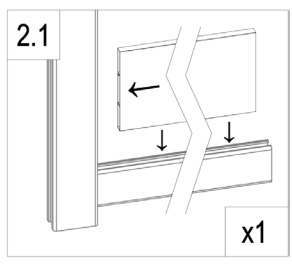
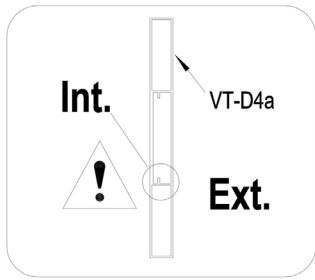
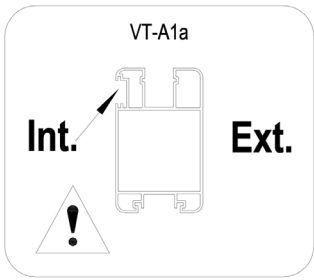
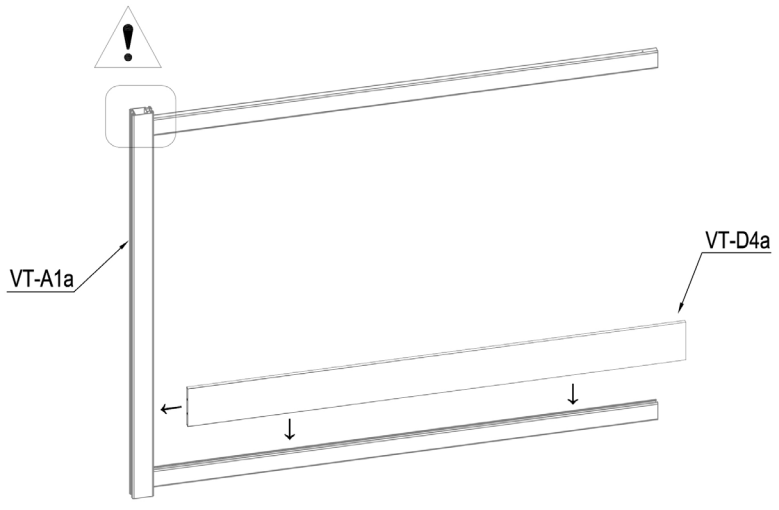

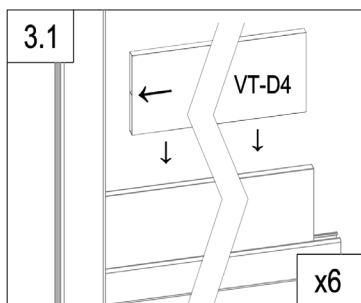
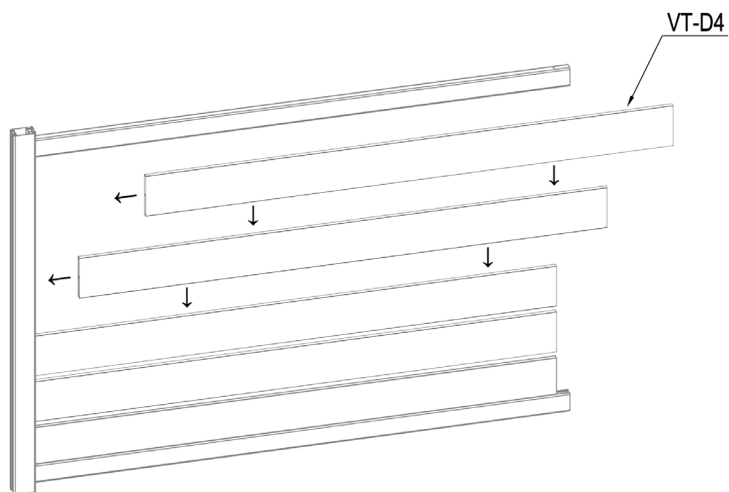

	VT-D4a	1
---	--------	---

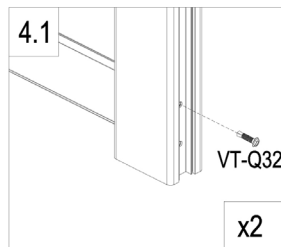
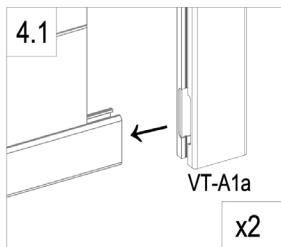
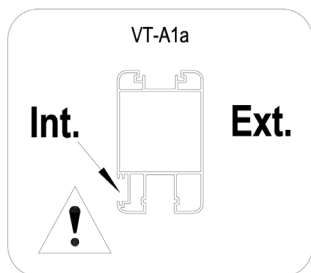
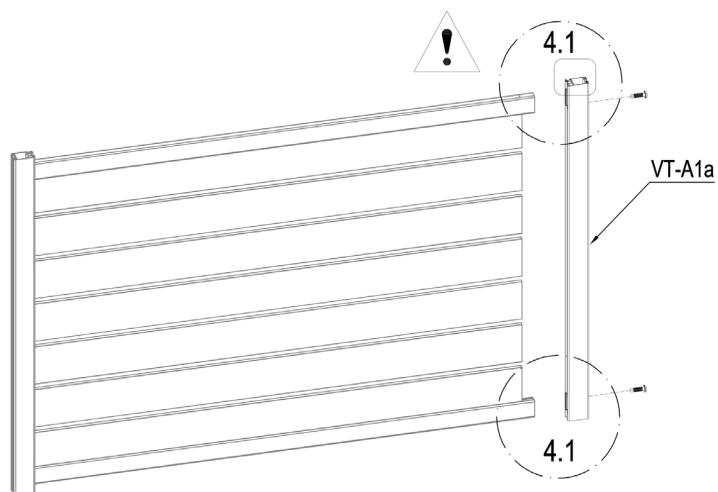

	VT-D4	6
---	-------	---



	VT-A1a	1
	VT-Q32	2

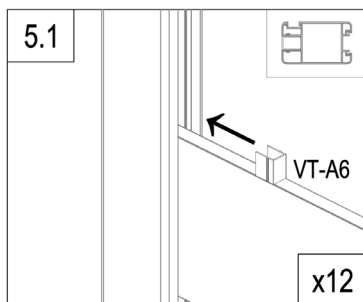
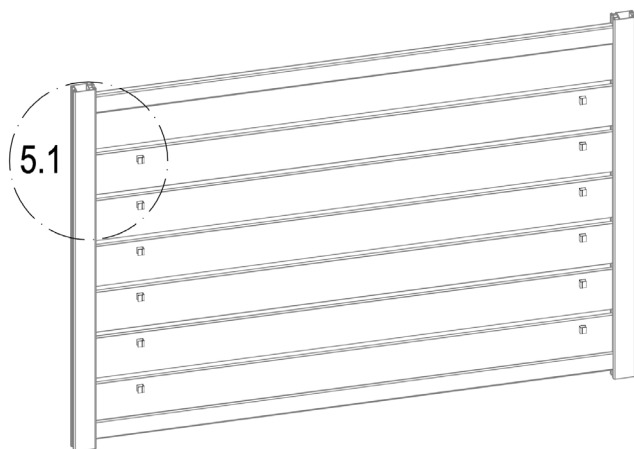

	VT-A6	12
---	-------	----

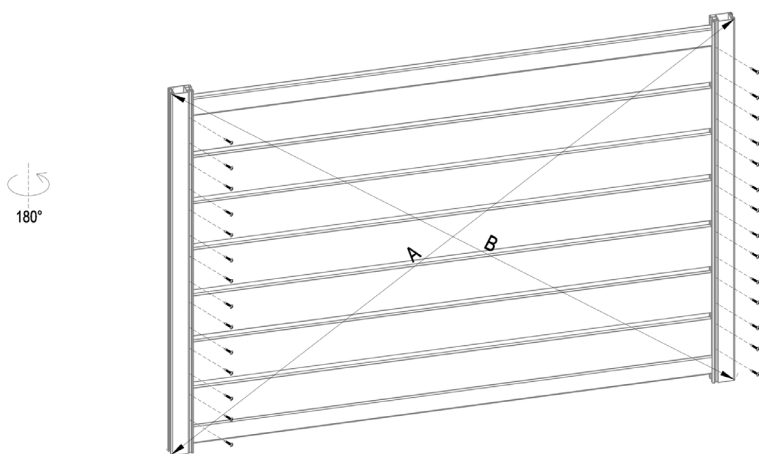

A=B

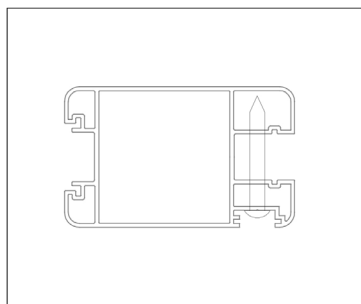
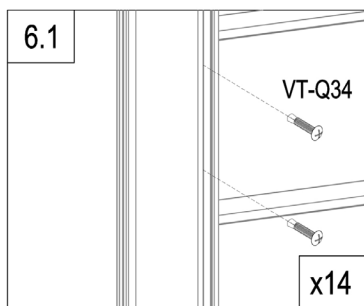

	VT-Q34	28
---	--------	----

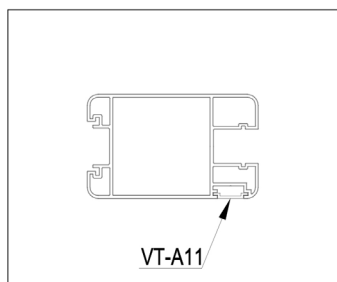
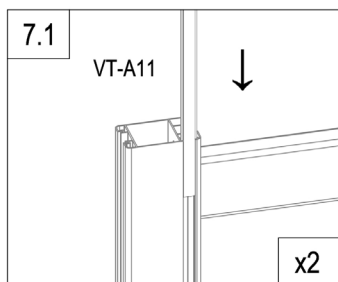
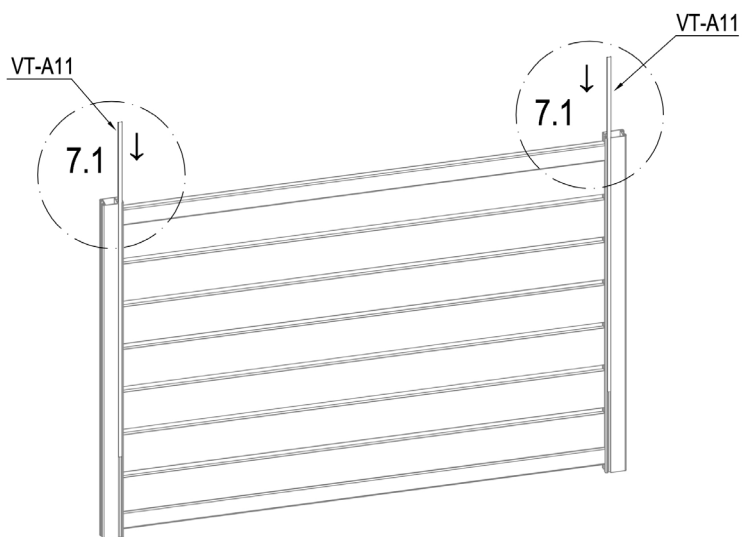

	VT-A11	2
---	--------	---

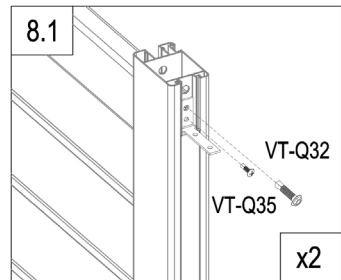
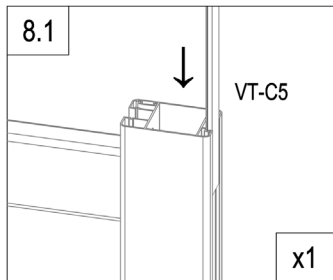
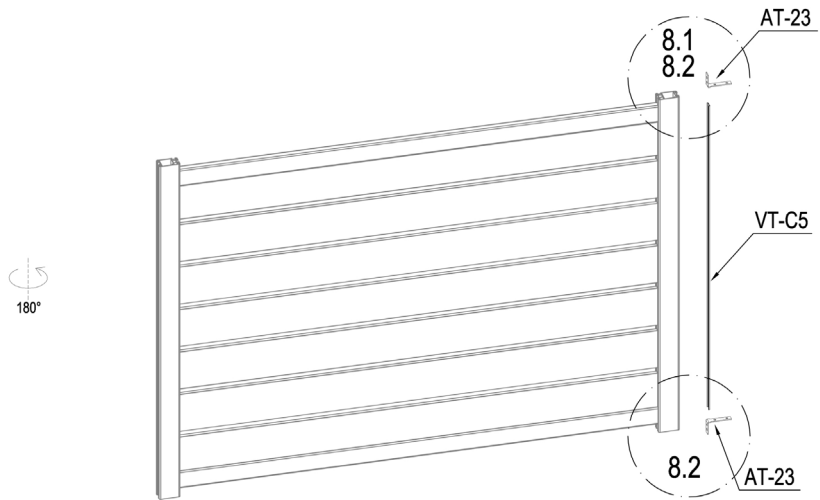



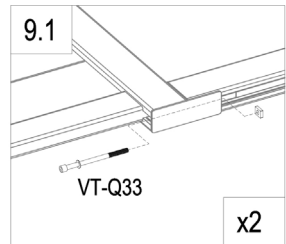
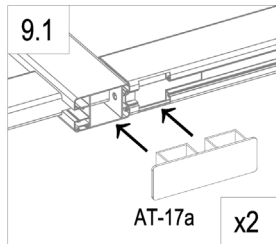
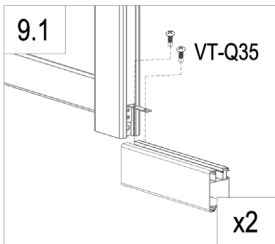
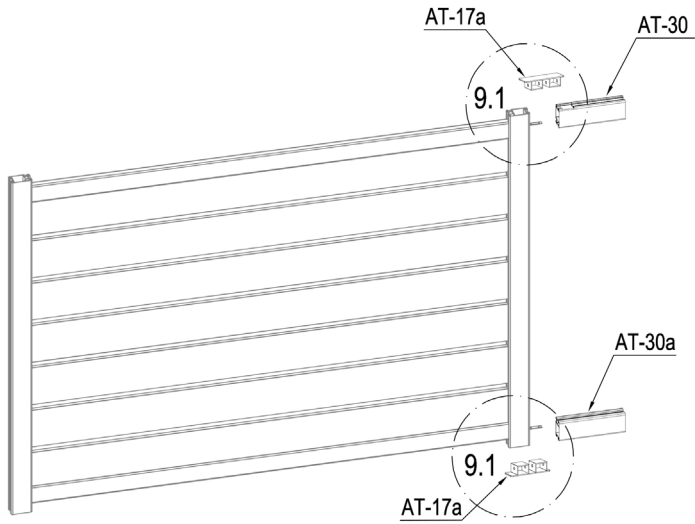

	VT-C5	1
	AT-23	2
	VT-Q32	2
	VT-Q35	2



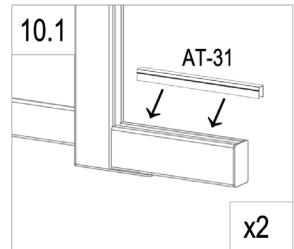
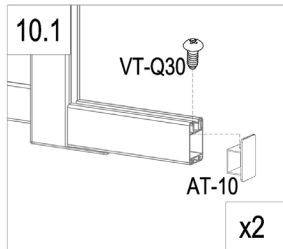
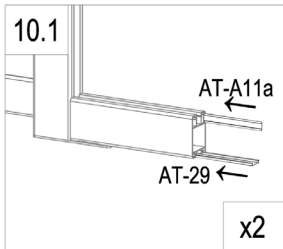
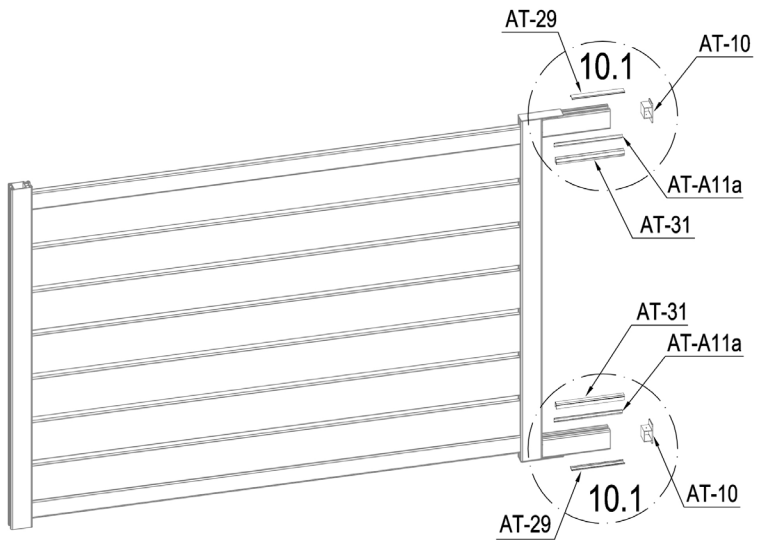

	AT-30	1
	AT-30a	1
	AT-17a	2





	VT-Q33	2
	VT-Q35	4



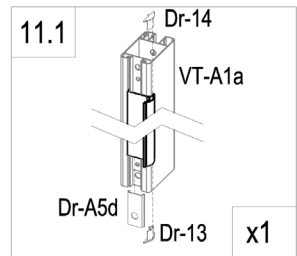
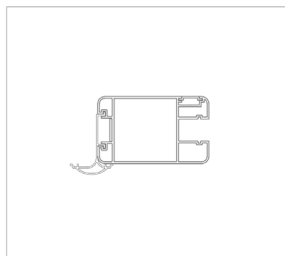
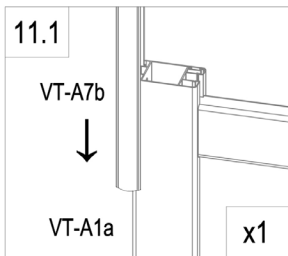
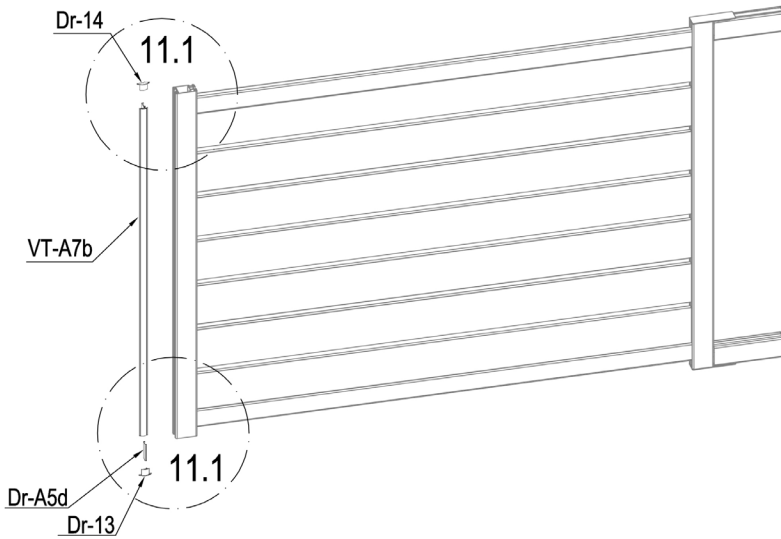



	AT-29	2
	AT-A11a	2
	AT-31	2

	AT-10	2
	VT-Q30	2

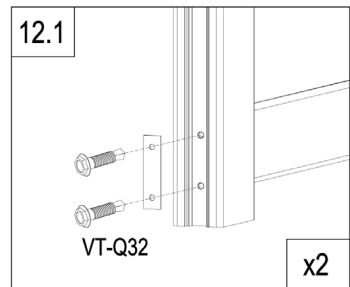
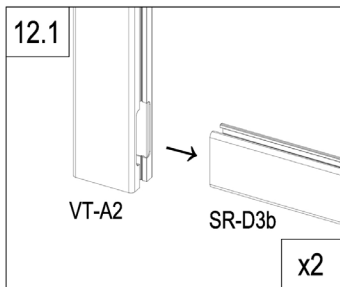
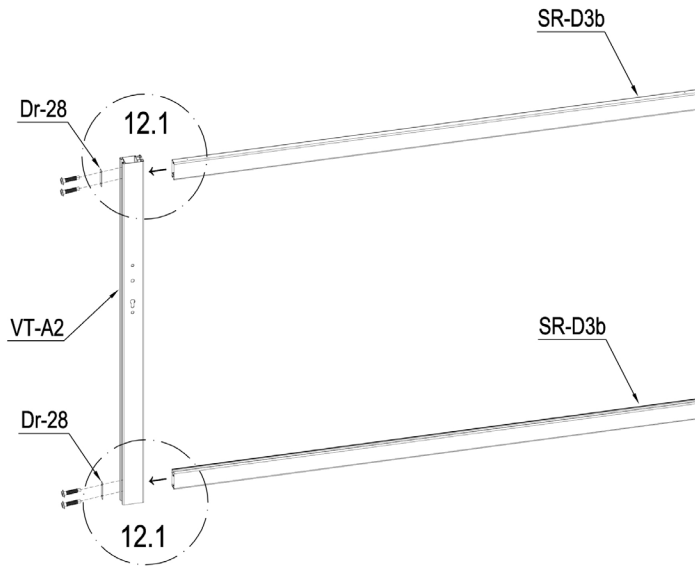

	VT-A7b	1
	Dr-A5d	1
	Dr-13	1
	Dr-14	1



	VT-A2	1
	SR-D3b	2
	Dr-28	2
	VT-Q32	4

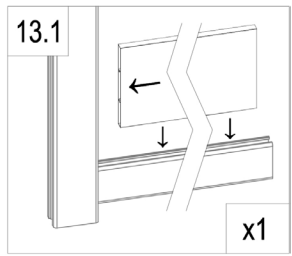
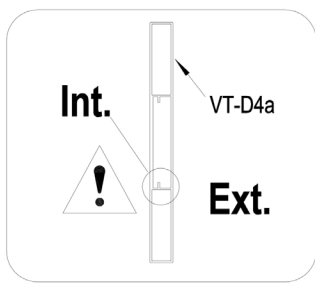
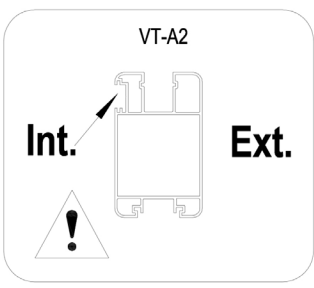
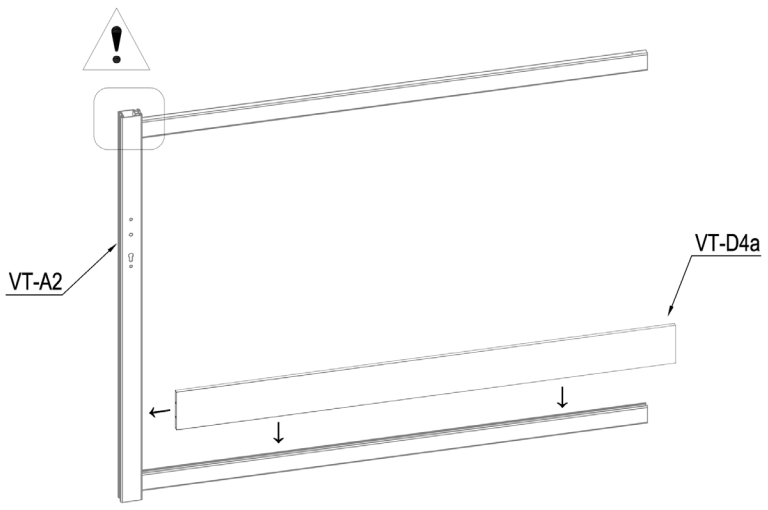

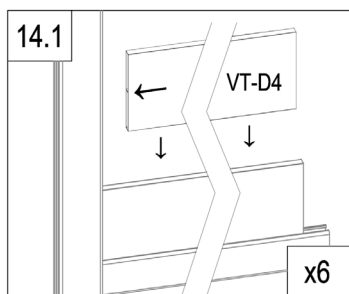
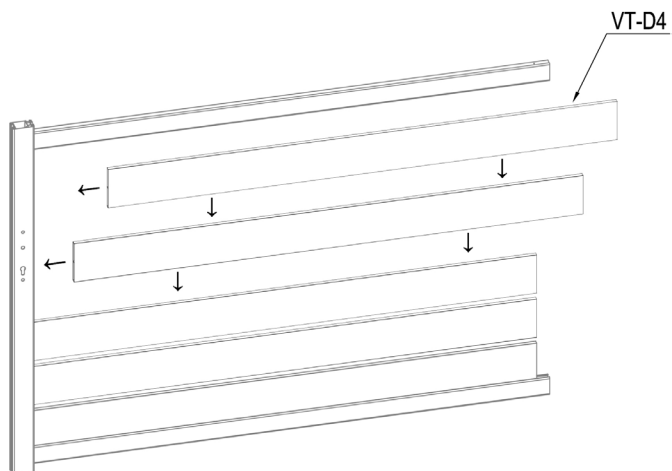

	VT-D4a	1
---	--------	---

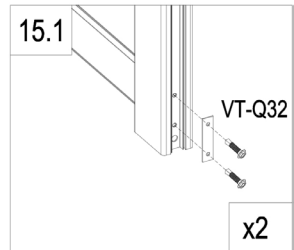
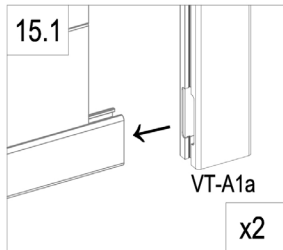
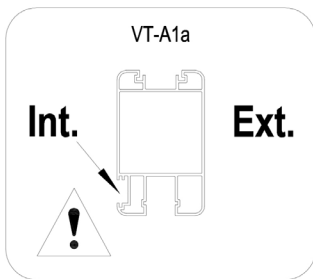
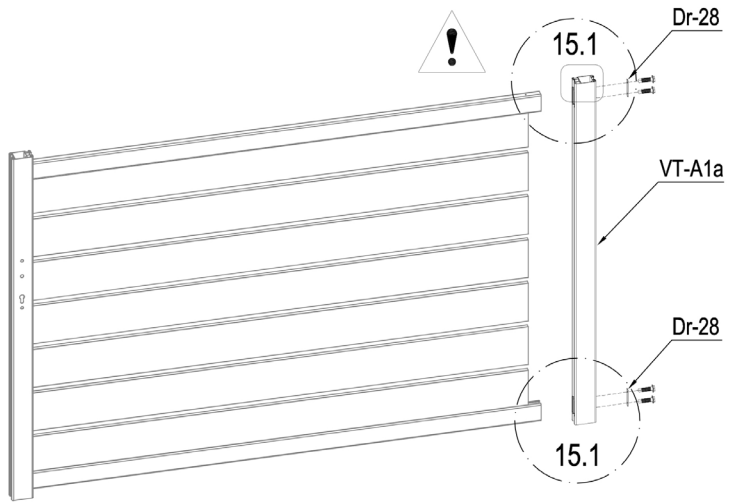

	VT-D4	6
---	-------	---



	VT-A1a	1
	Dr-28	2
	VT-Q32	4

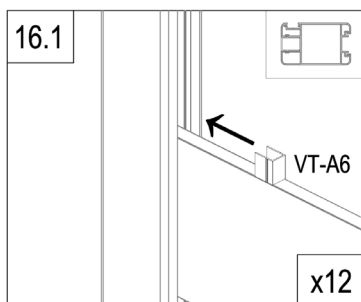
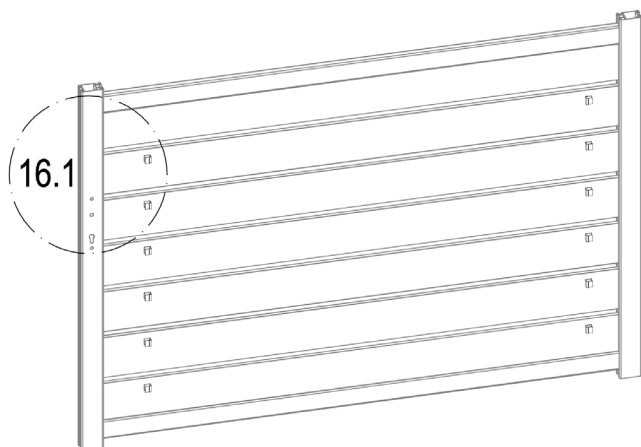

	VT-A6	12
---	-------	----

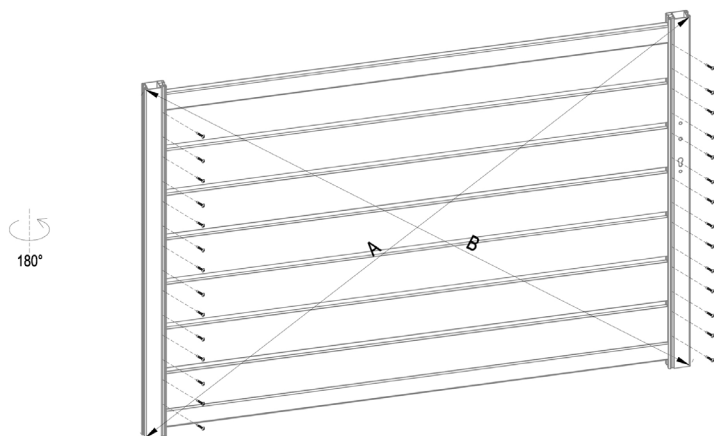

A=B

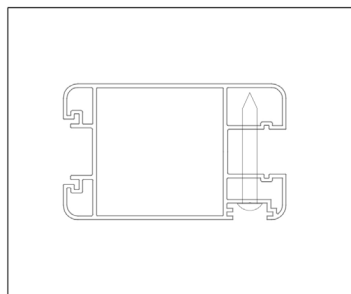
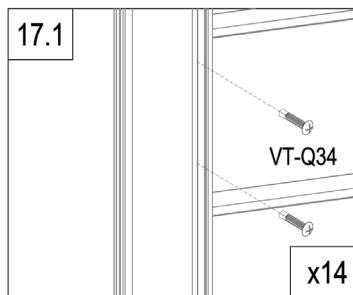

	VT-Q34	28
---	--------	----

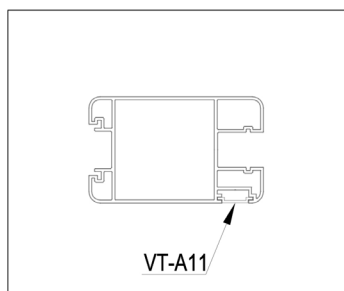
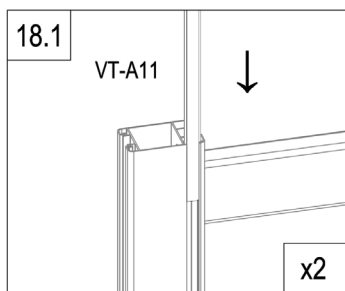
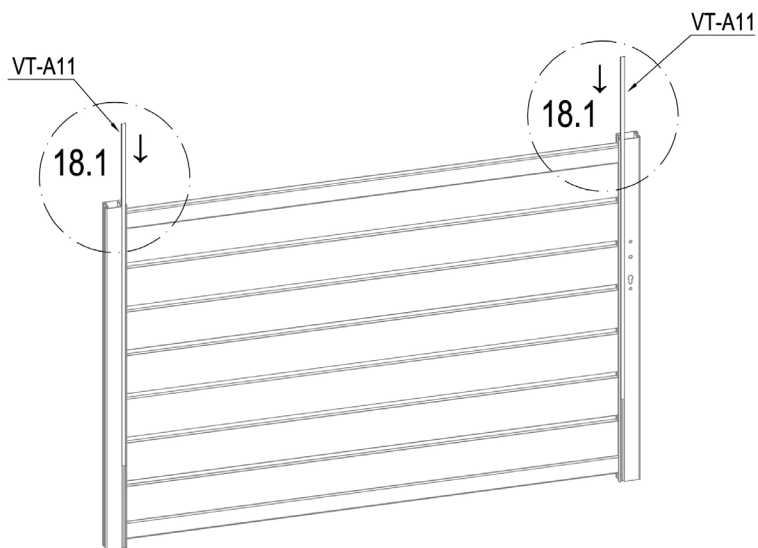

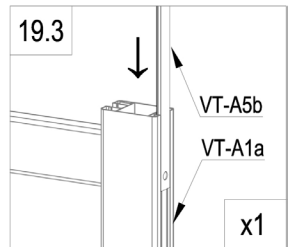
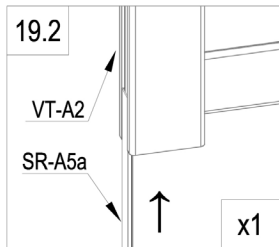
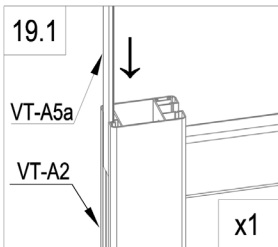
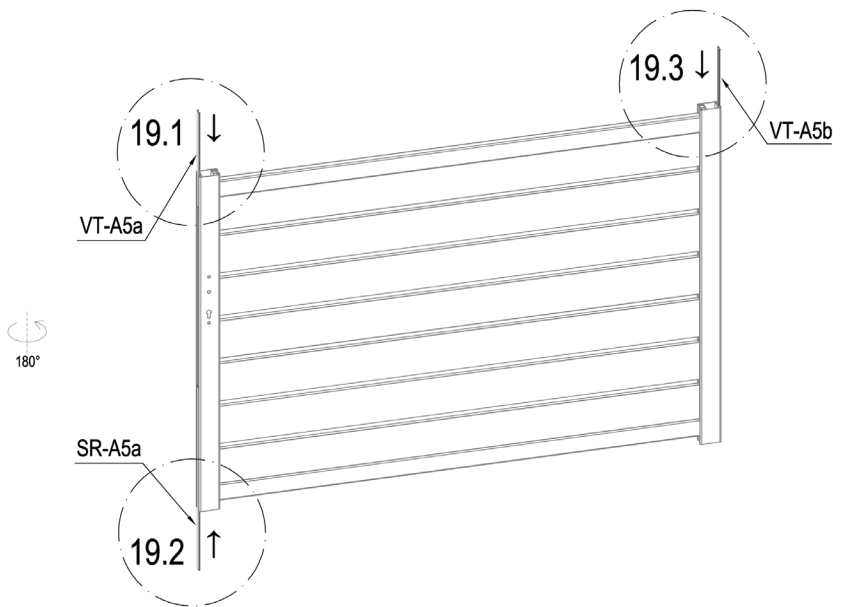

	VT-A11	2
---	--------	---



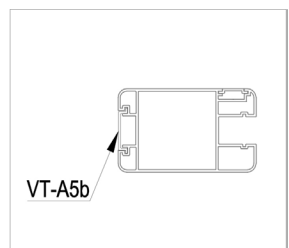

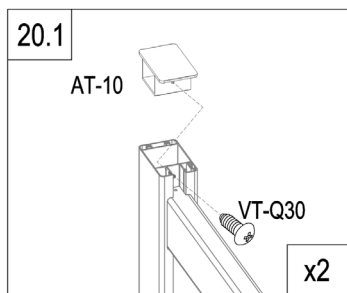
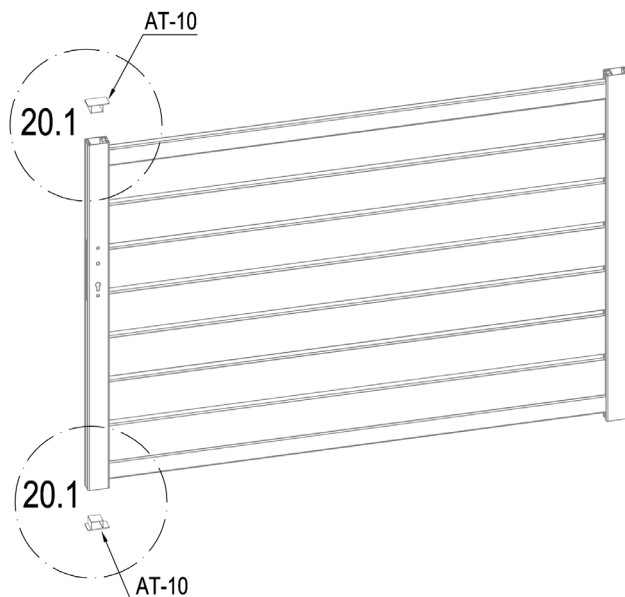
	VT-A5b	1
	VT-A5a	1
	SR-A5a	1



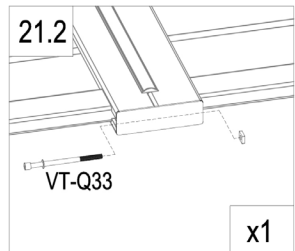
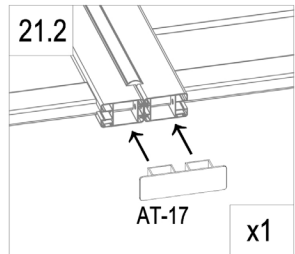
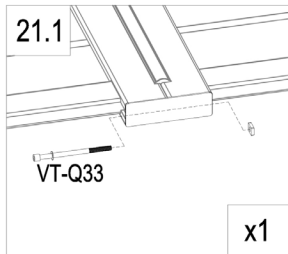
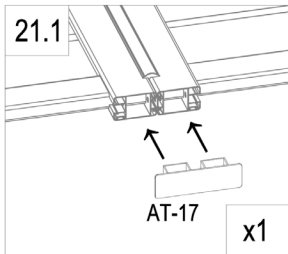
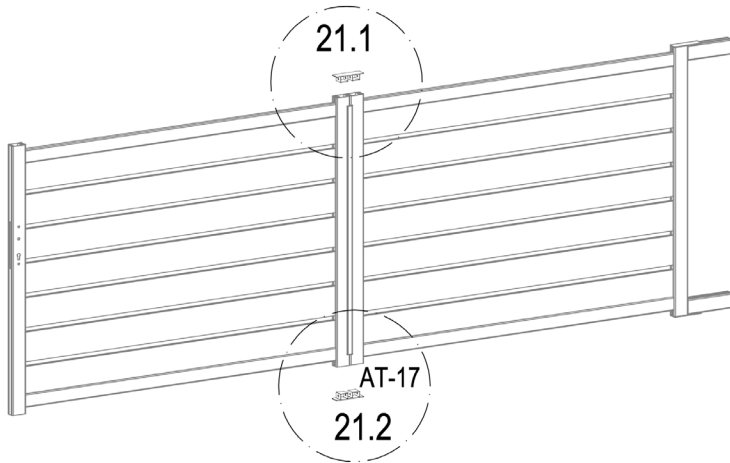

	AT-10	2
	VT-Q30	2



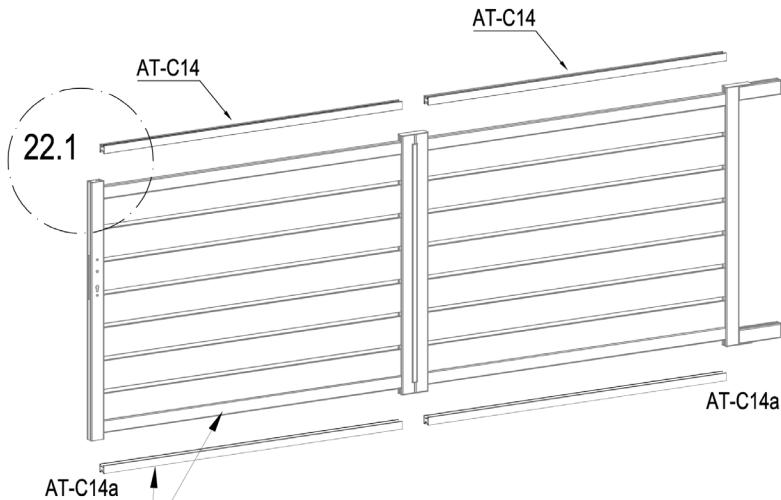

	AT-17	2
	VT-Q33	2



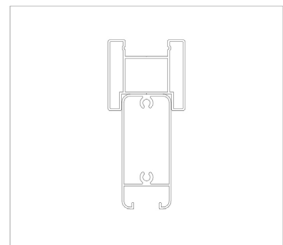
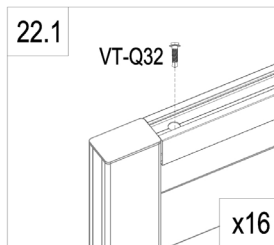
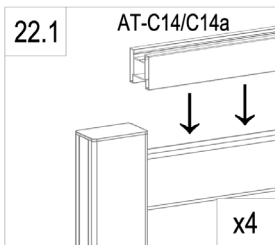

EN: These parts are made for connecting your gate's automation
 FR: Ces pièces sont faites pour relier l'automatisation de votre portail
 DE: Diese Teile sind für den Anschluss der Automatisierung Ihres Tores vorgesehen
 ES: Estas piezas están hechas para conectar la automatización de su puerta
 PT: Estas peças são feitas para ligar a automatização do seu portão
 IT: Queste parti sono realizzate per collegare l'automazione del vostro cancello
 NL: Deze onderdelen zijn gemaakt voor het aansluiten van de automatisering van uw poort.
 PL: Te części są wykonane do podłączenia automatyki bramy.



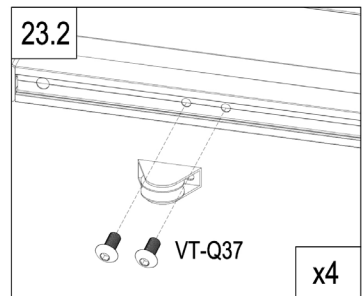
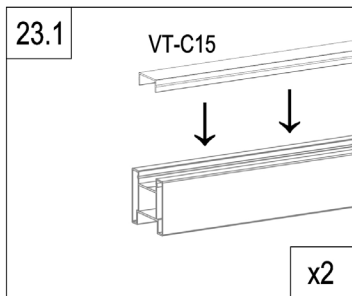
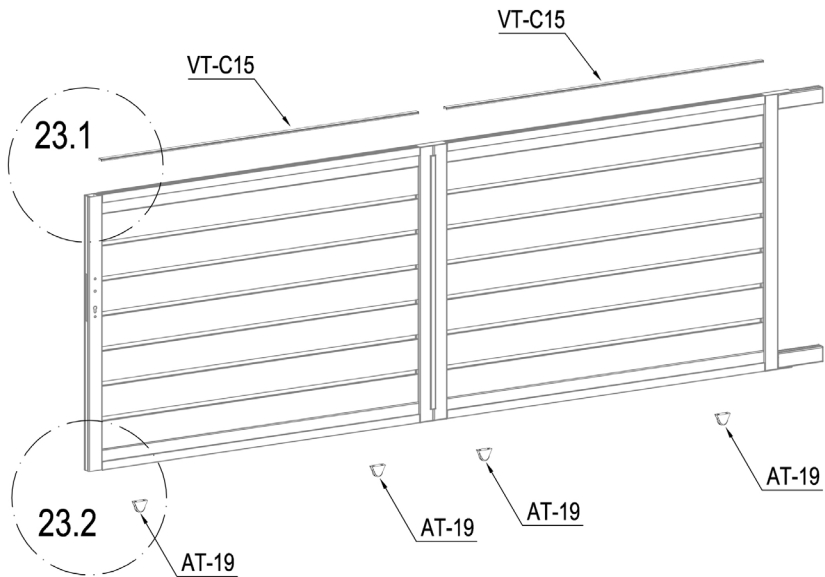

	AT-C14	2
	AT-C14a	2
	VT-Q32	16

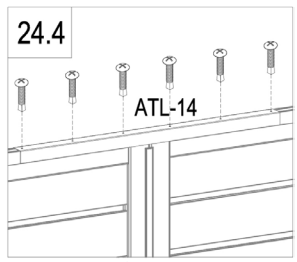
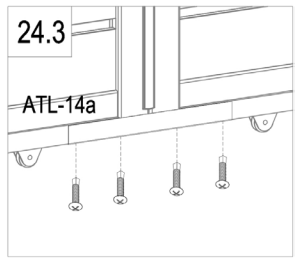
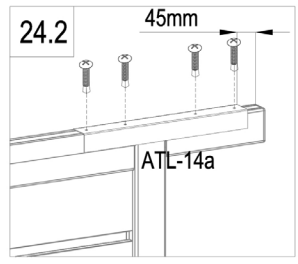
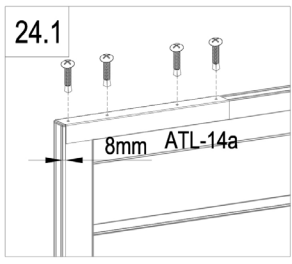
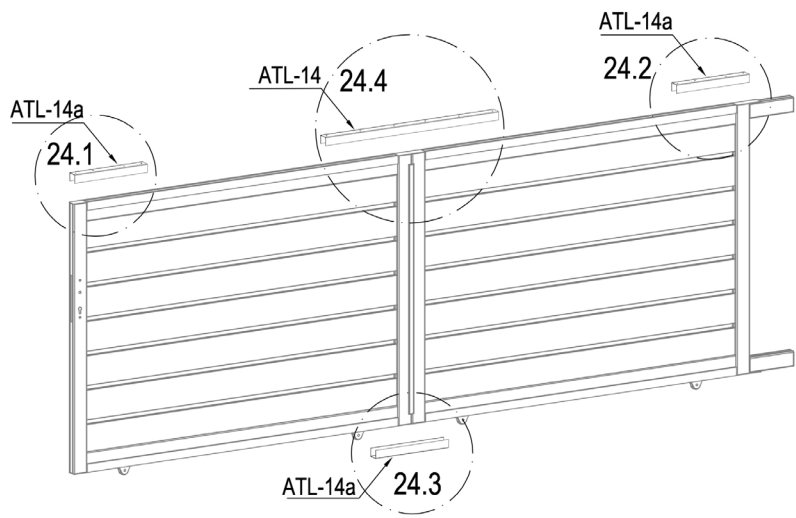

	VT-C15	2
	AT-19	4
	VT-Q37	8



	ATL-14	1
	ATL-14a	3
	VT-Q34	18

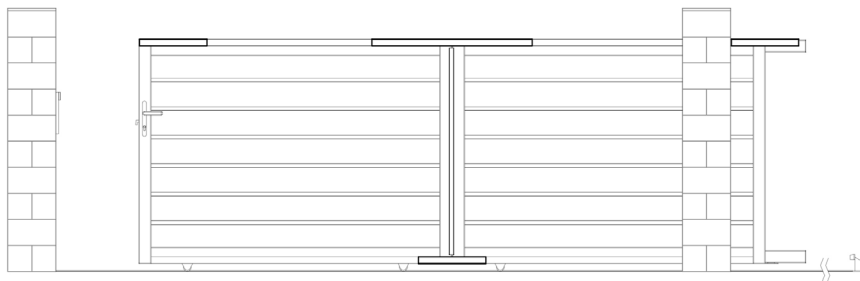

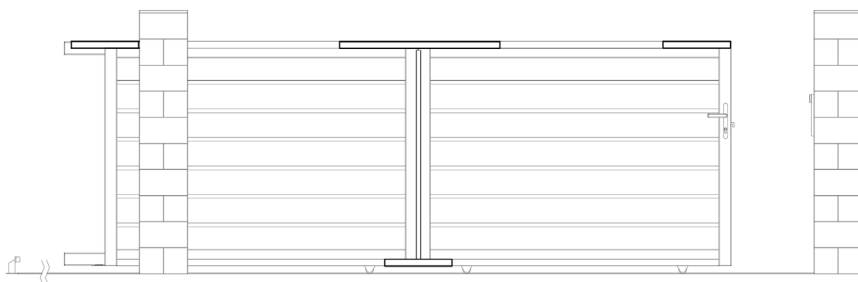

L : P25~30

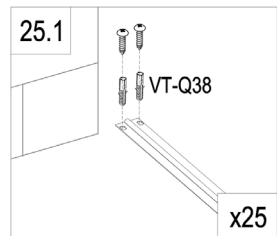
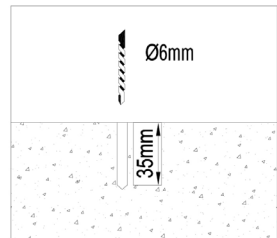
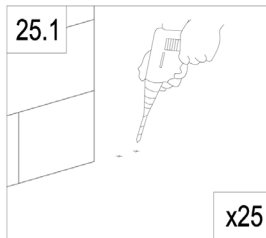
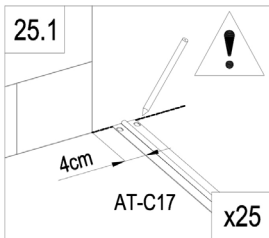
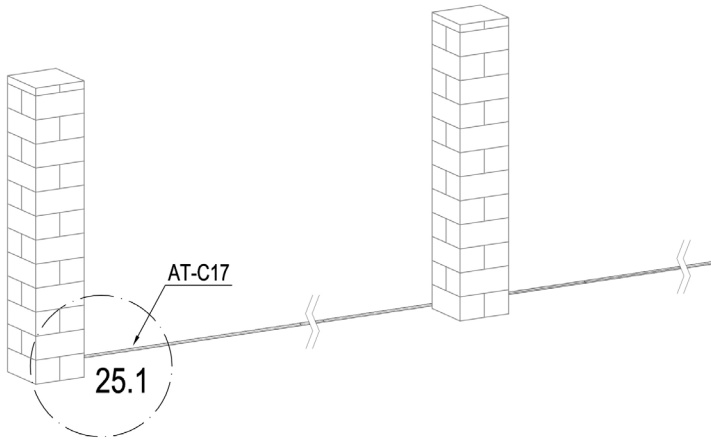

R : P31~36

L



	AT-C17	5
	VT-Q38	50

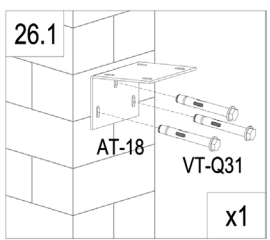
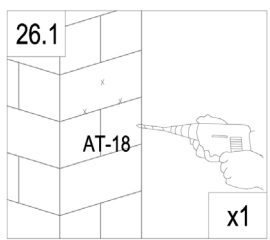
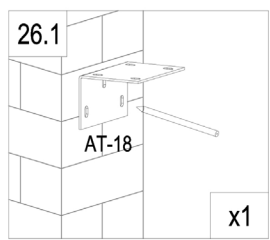
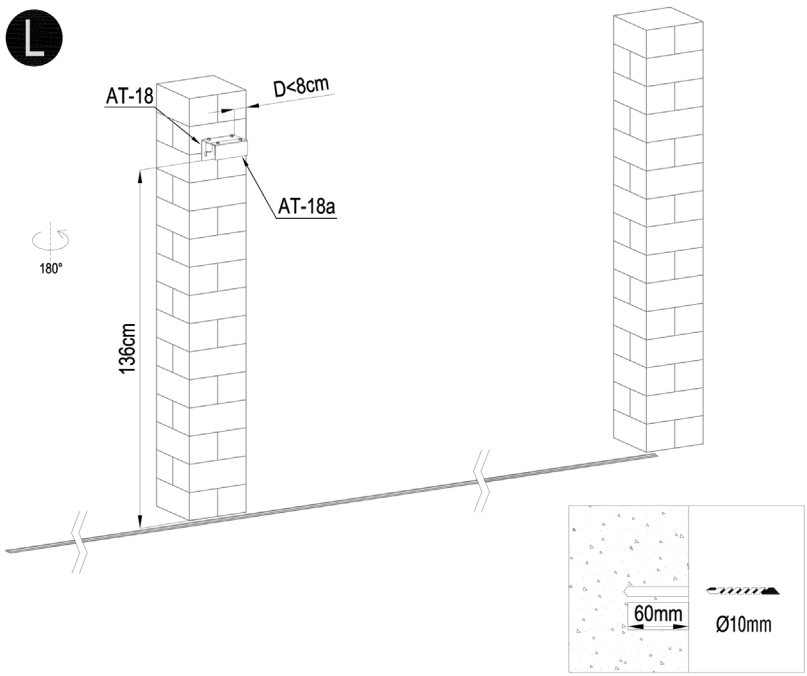

	AT-18	1
	AT-18a	1
	AT-20	4
	VT-Q31	3

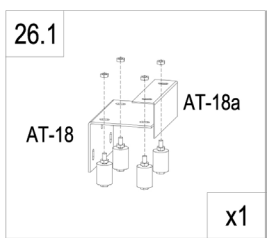
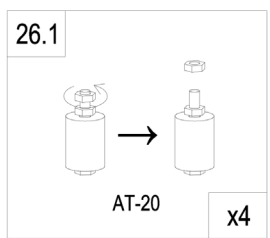



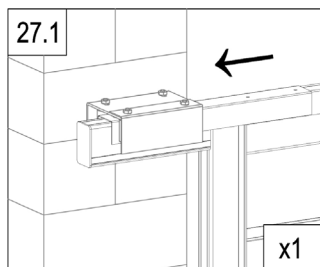
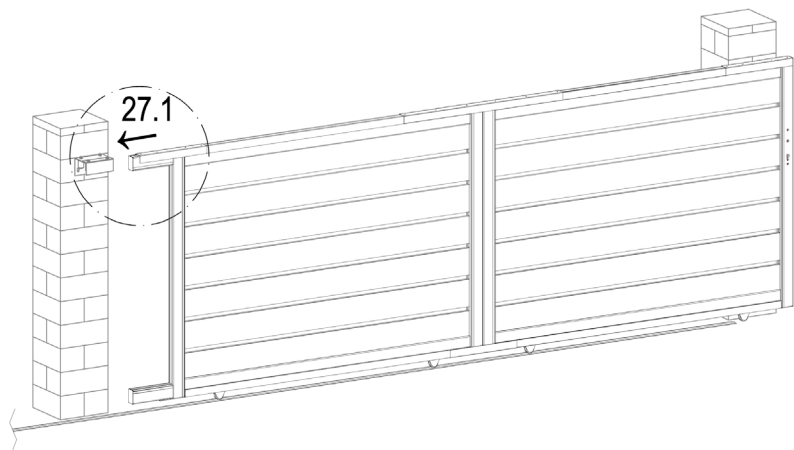

L

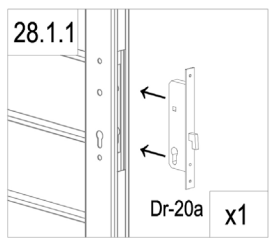
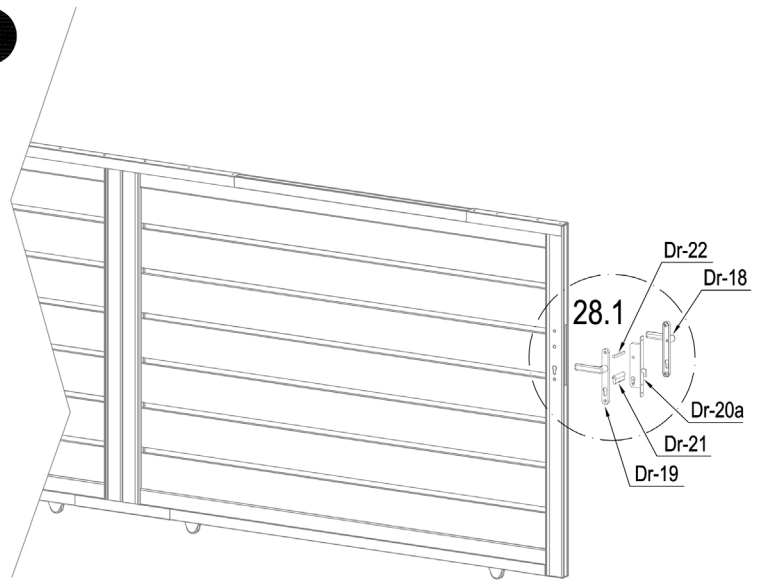





L

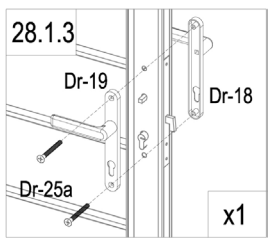
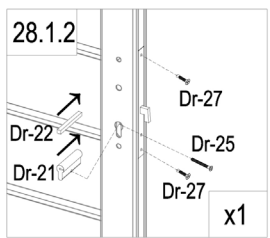

	Dr-20a	1
	Dr-21	1
	Dr-22	1
	Dr-25	1



	Dr-18	1
	Dr-19	1
	Dr-25a	2
	Dr-27	2

L

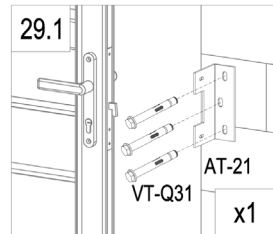
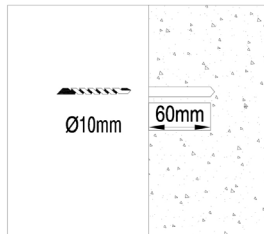
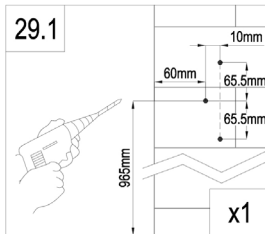
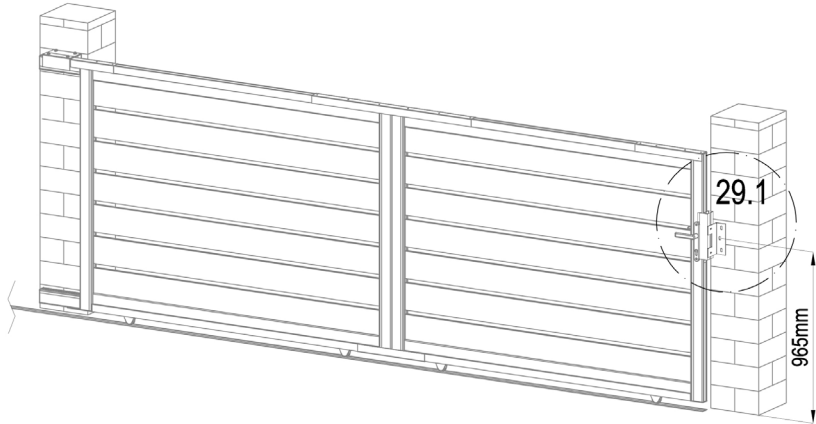

	AT-16	1
	AT-21	1
	VT-Q36	2
	VT-Q31	3
	AT-22J	3

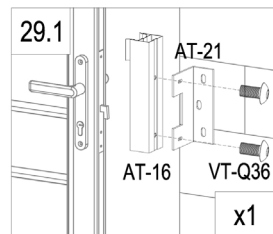
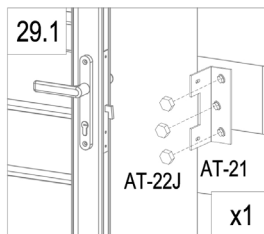

L

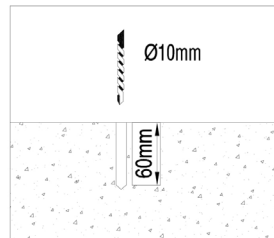
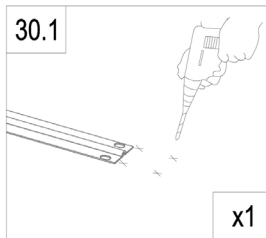
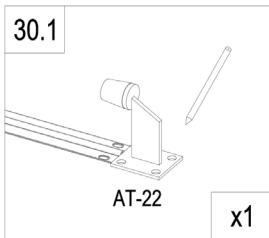
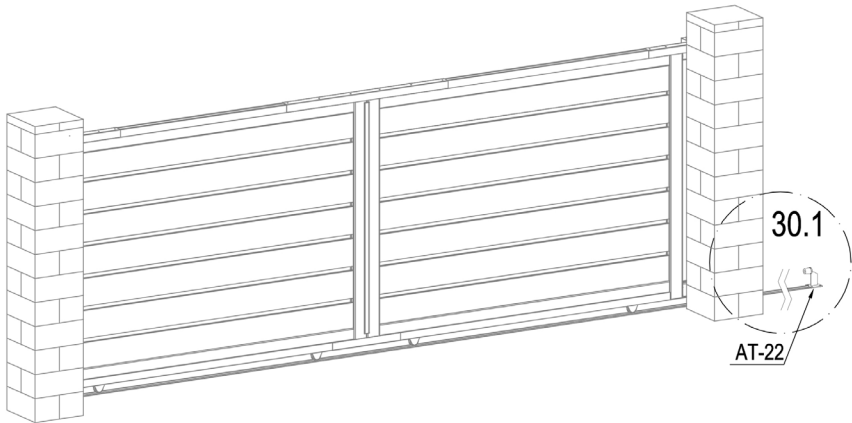

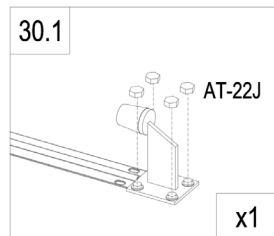
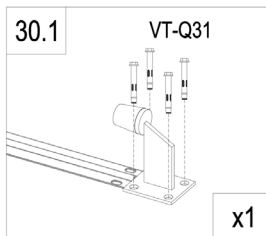

	AT-22	1
	VT-Q31	4
	AT-22J	4

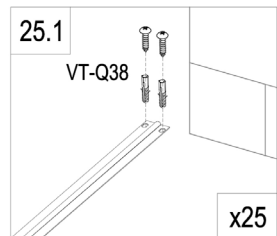
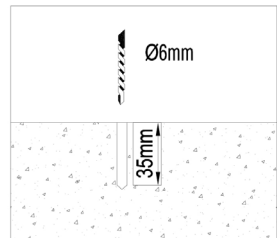
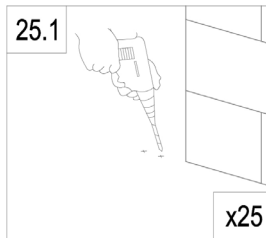
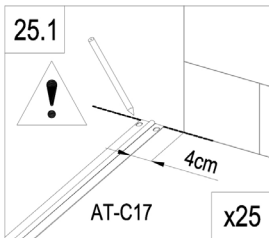
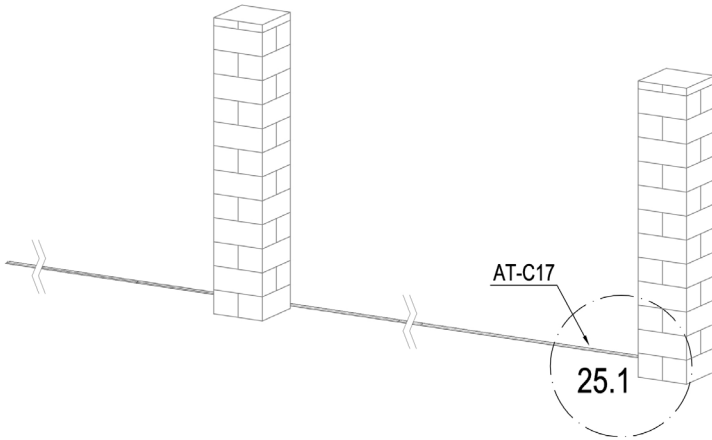

R



	AT-C17	5
	VT-Q38	50

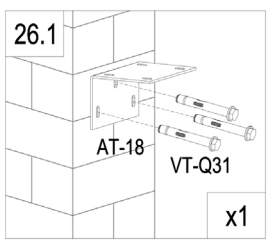
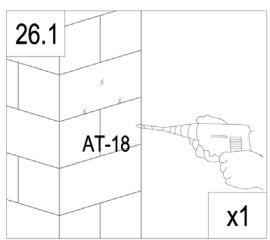
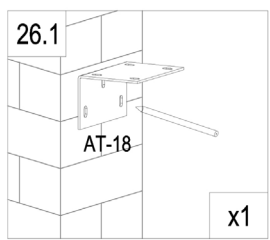
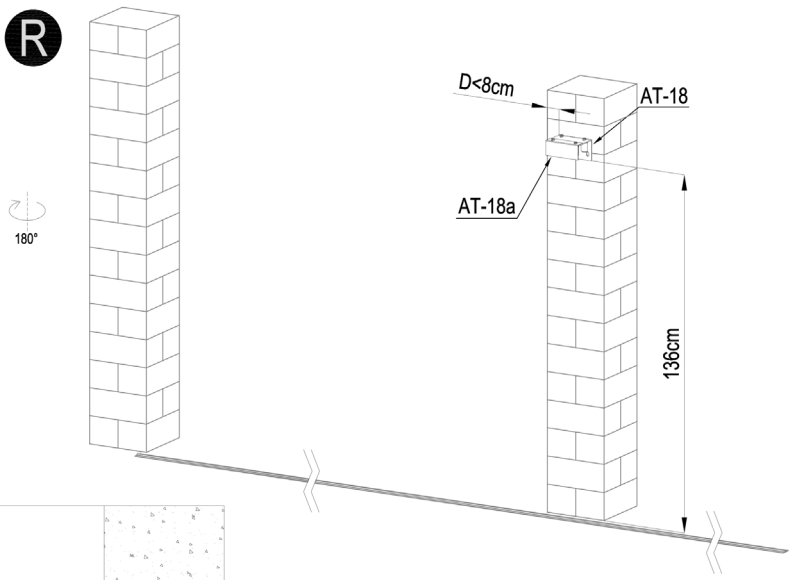

	AT-18	1
	AT-18a	1
	AT-20	4
	VT-Q31	3

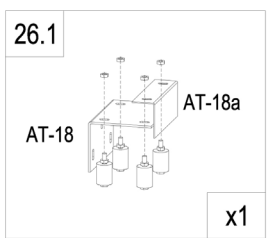
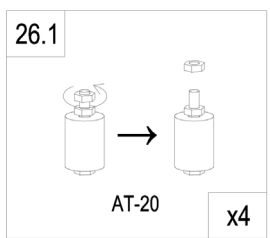

R

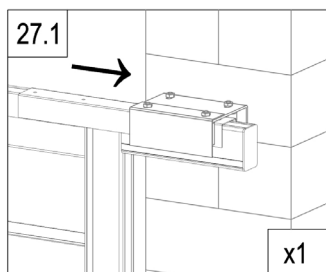
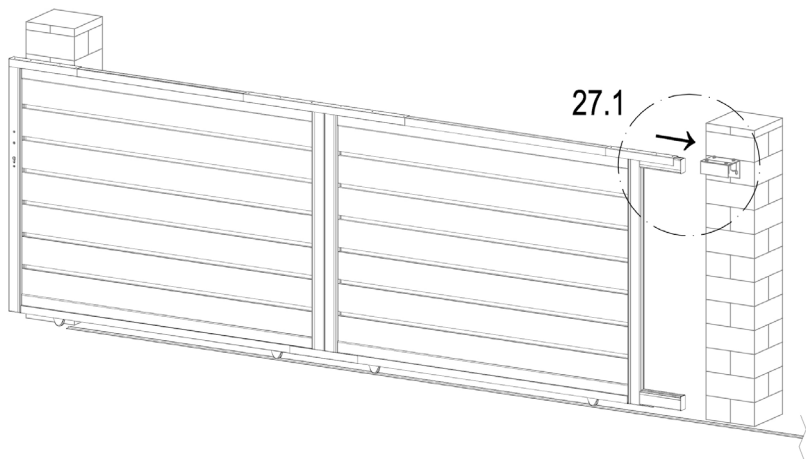

R

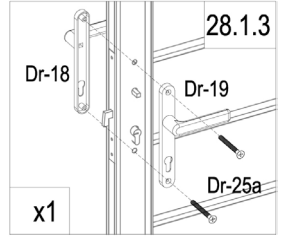
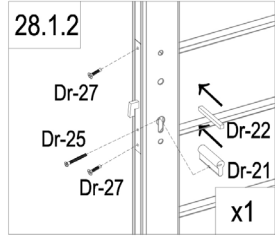
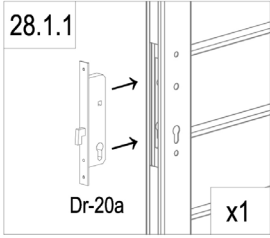
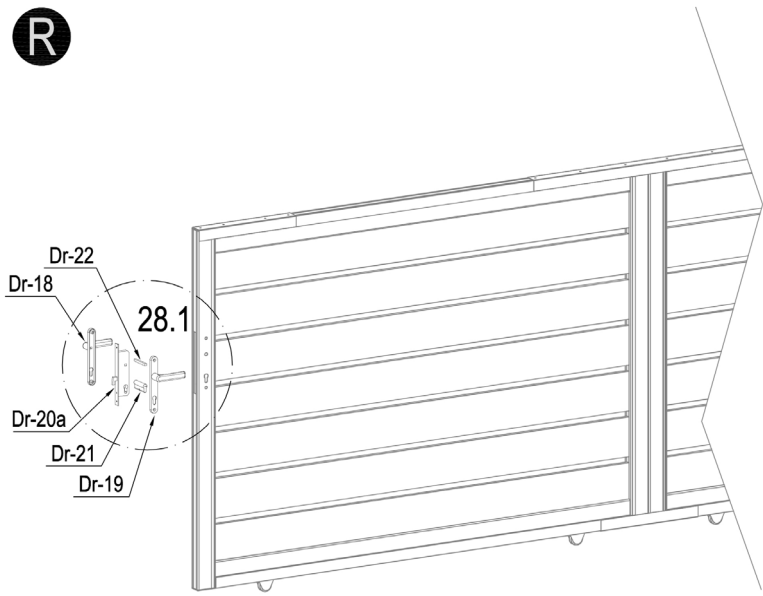

	Dr-20a	1
	Dr-21	1
	Dr-22	1
	Dr-25	1

	Dr-18	1
	Dr-19	1
	Dr-25a	2
	Dr-27	2

R

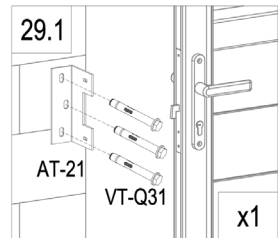
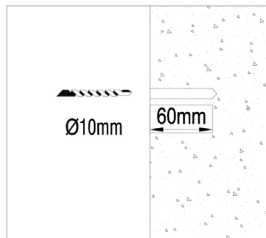
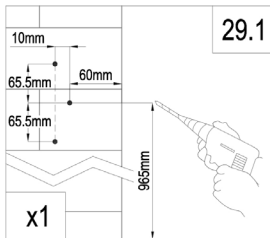
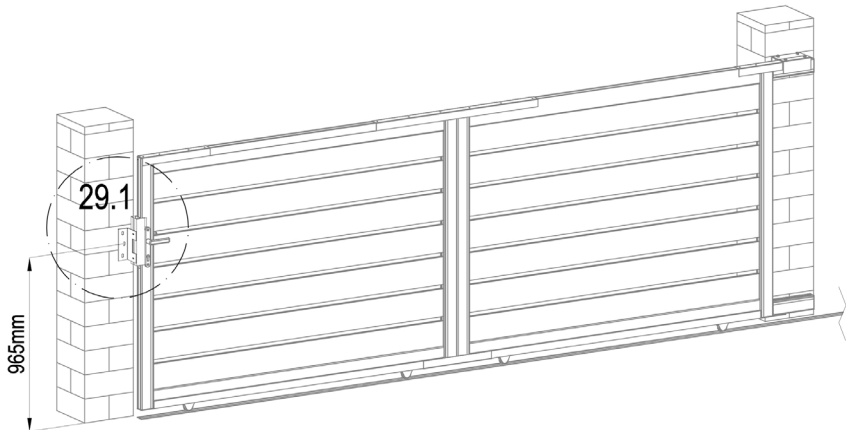

	AT-16	1
	AT-21	1
	VT-Q36	2
	VT-Q31	3
	AT-22J	3

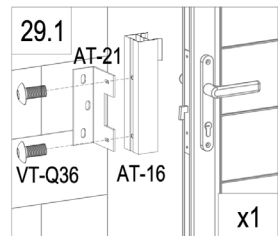
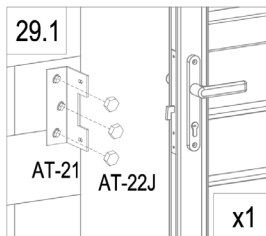

R

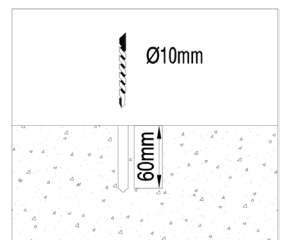
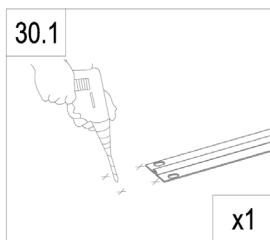
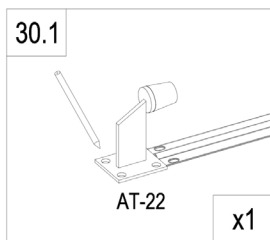
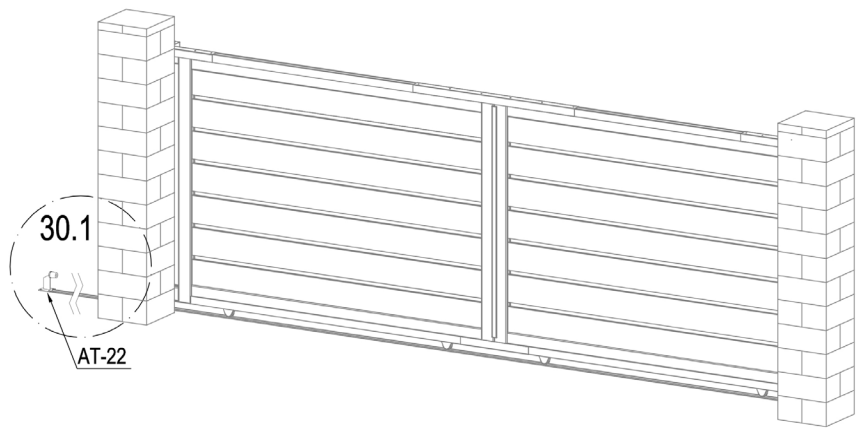

	AT-22	1
	VT-Q31	4
	AT-22J	4

