

CASANOVO

EIGER 400C180

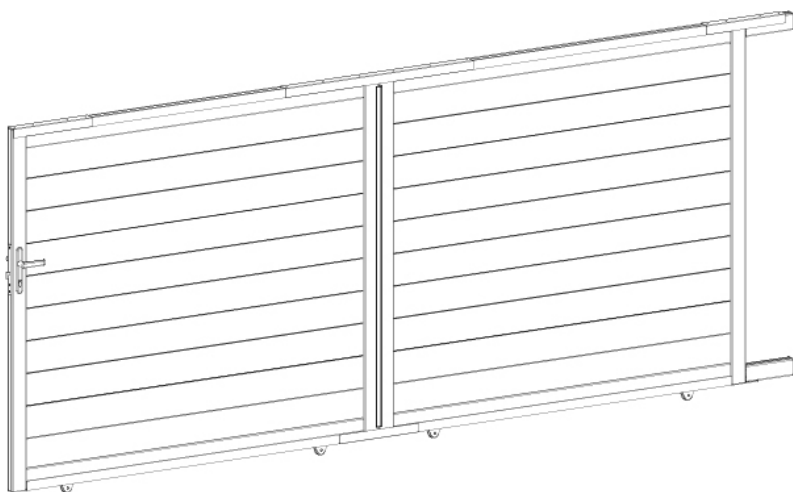

COM-000101 [x1]

COM-000103 [x1]

COM-000102 [x1]

COM-000104 [x1]



INSTRUCTION MANUAL / NOTICE DE MONTAGE / MONTAGEANLEITUNG / MANUAL DE MONTAJE / MANUAL DE MONTAGEM / MANUALE DI MONTAGGIO /
MONTAGEHANDLEIDING / INSTRUKCJA MONTAŻU / KÄYTTÖOHJEET / BRUKSANVISNING / BRUGSANVISNING / INSTRUCȚIUNI DE ASAMBLARE /
NAVODILA ZA SESTAVLJANJE / NÁVOD NA MONTÁŽ / ÖSSZESZERELÉSI ÚTMUTATÓ / NÁVOD K MONTÁŽI / UPUTE ZA INSTALACIJU /
ΟΔΗΓΙΕΣ ΣΥΝΑΡΜΟΛΟΓΗΣΗΣ / SURINKIMO INSTRUKCIJOS / MONTŽAS INSTRUKCIJAS

Ext.

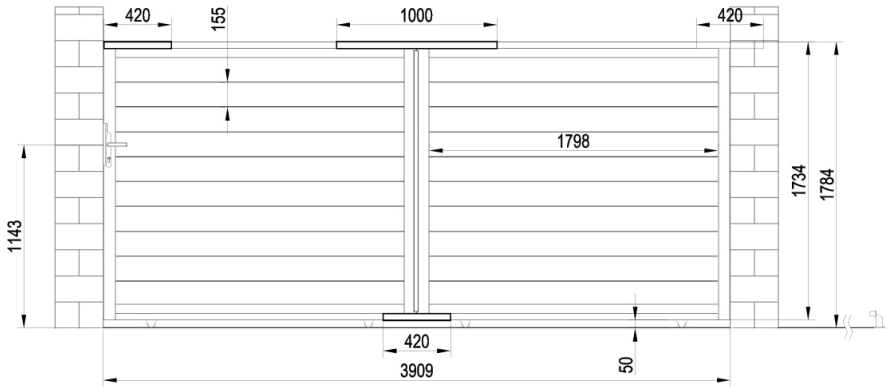

Int.

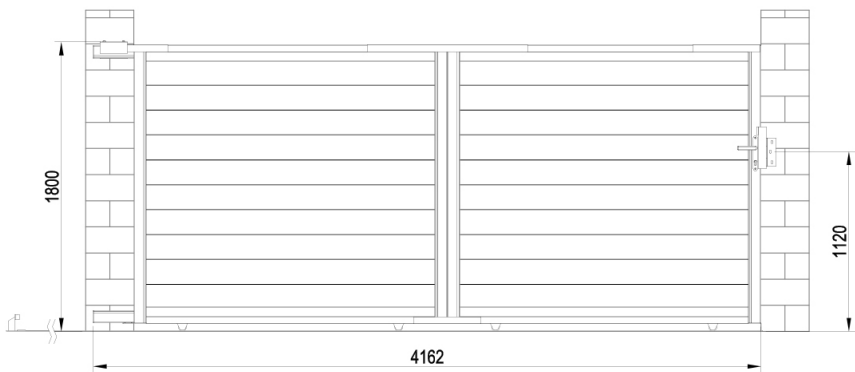



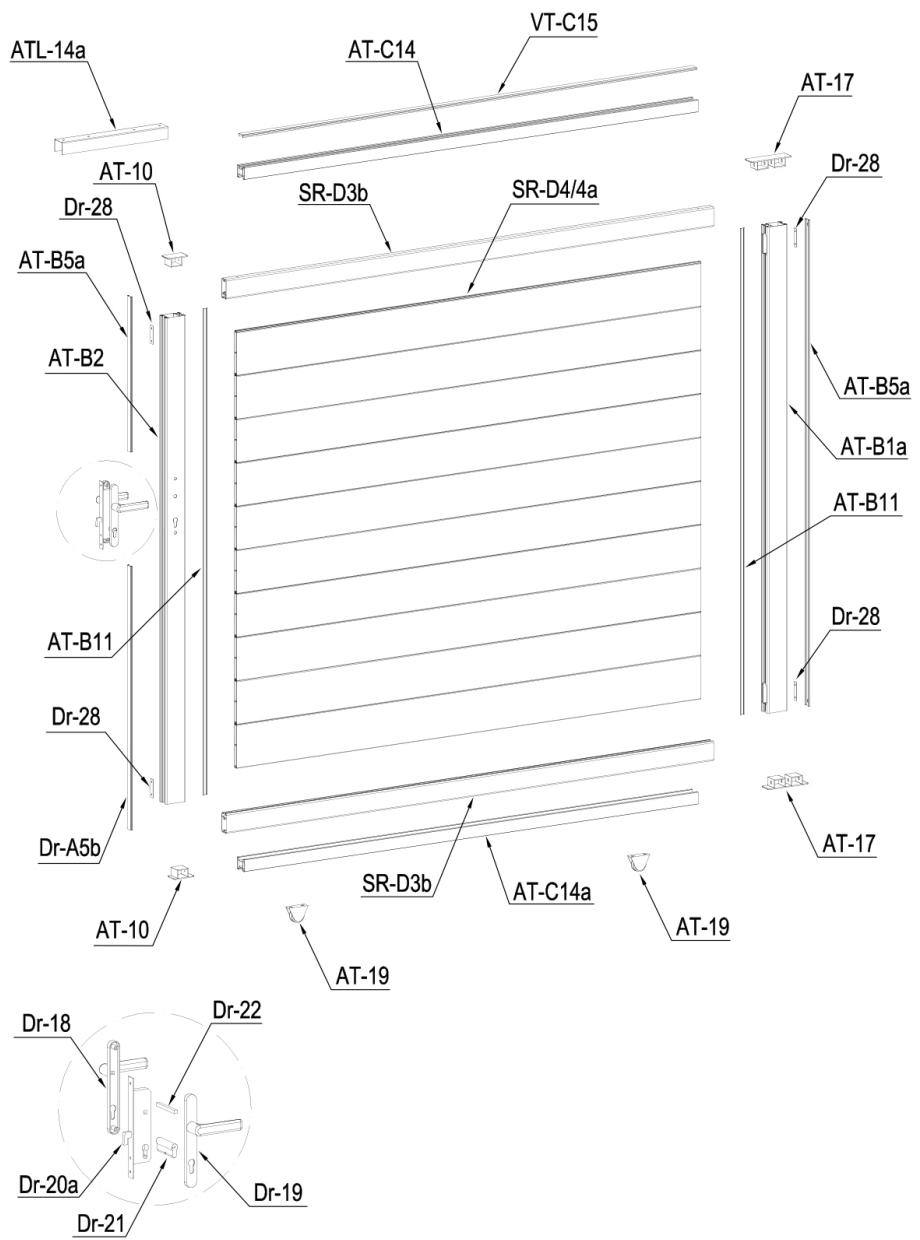

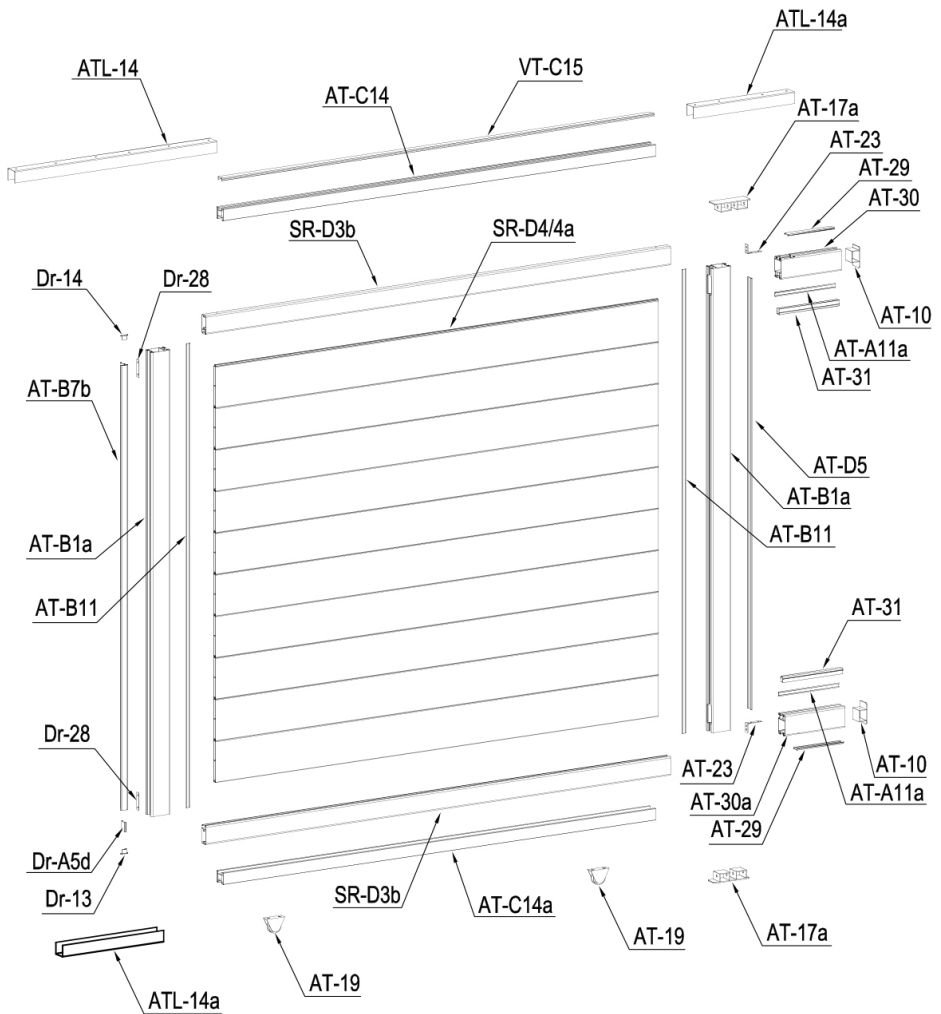

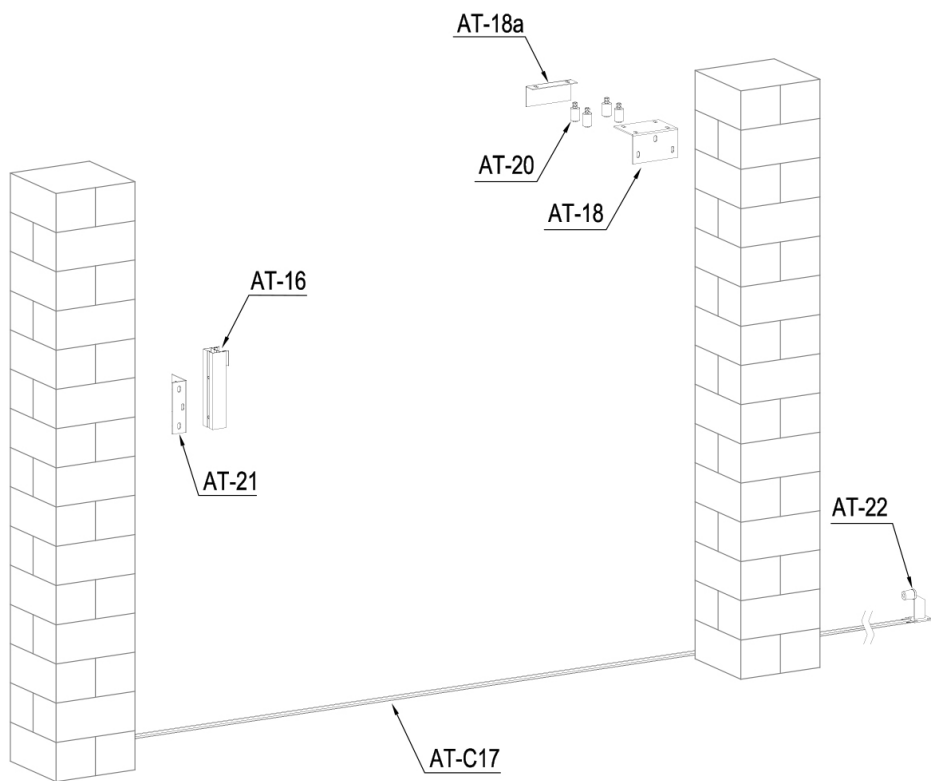





































CASANOVO









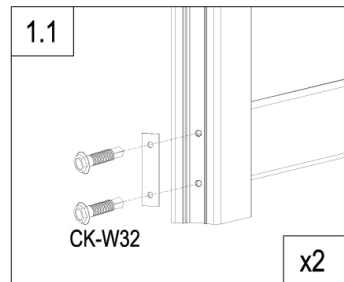
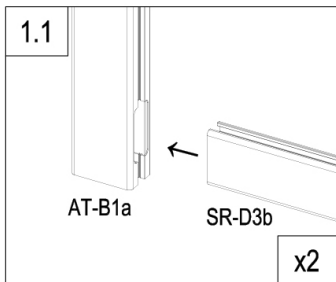
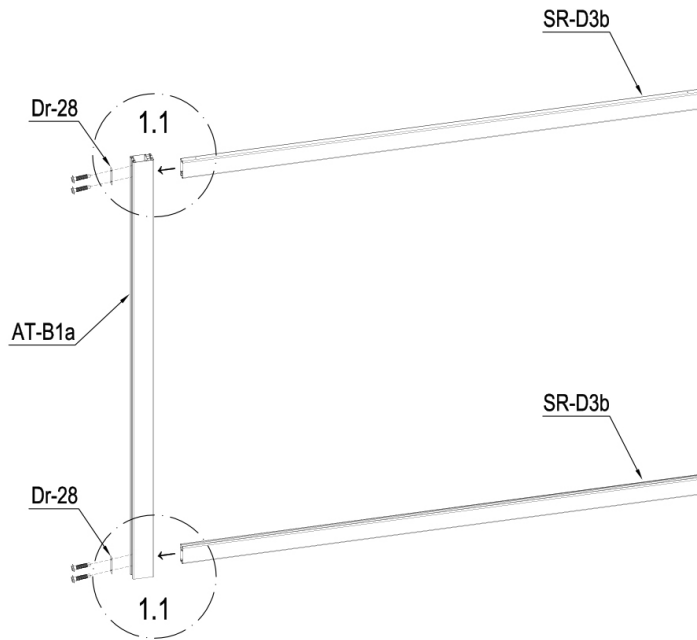

PART LIST

IMAGE	NO.	L.(mm)	QTY	IMAGE	NO.	L.(mm)	QTY
	AT-B1a	1728	3		AT-10		4
	AT-B2	1728	1		AT-18		1
	AT-30	250	1		AT-18a		1
	AT-30a	250	1		AT-19		4
	SR-D3b	1931	4		AT-20		4
	SR-D4	1840	18		AT-21		1
	SR-D4a	1840	2		AT-22		1
	AT-B5b	1728	1		AT-23		2
	AT-D5	1603	1		Dr-18		1
	AT-B5a	550.5	1		Dr-19		1
	Dr-A5b	937	1		Dr-20a		1
	AT-29	193	2		Dr-21		1
	Dr-A5d	52	1		Dr-22		1
	AT-B11	1728	4		Dr-25		1
	AT-A11a	250	2		Dr-25a		2
	AT-31	250	2		Dr-27		2
	AT-B7b	1623	1		CK-W30		4
	AT-C14	1798	2		CK-W31		10
	AT-C14a	1798	2		CK-W32		32
	VT-C15	1797	2		CK-W33		4
	AT-16	260	1		CK-W34		99
	AT-C17	1580	5		CK-W35		6
	ATL-14	1000	1		CK-W36		2
	ATL-14a	420	3		CK-W37		8
	Dr-13		1		CK-W38		50
	Dr-14		1		Dr-28		6
	AT-17		2		AT-22J		7
	AT-17a		2				



	AT-B1a	1
	SR-D3b	2
	Dr-28	2
	CK-W32	4

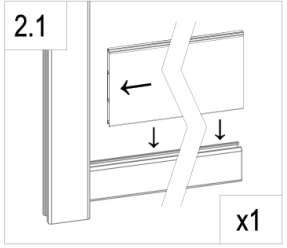
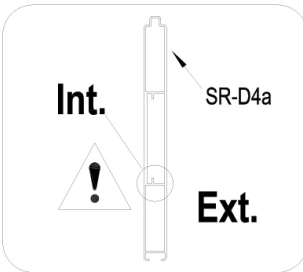
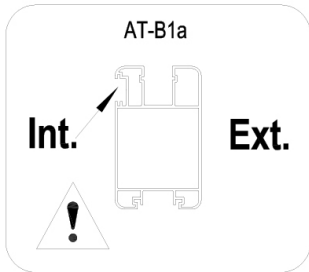
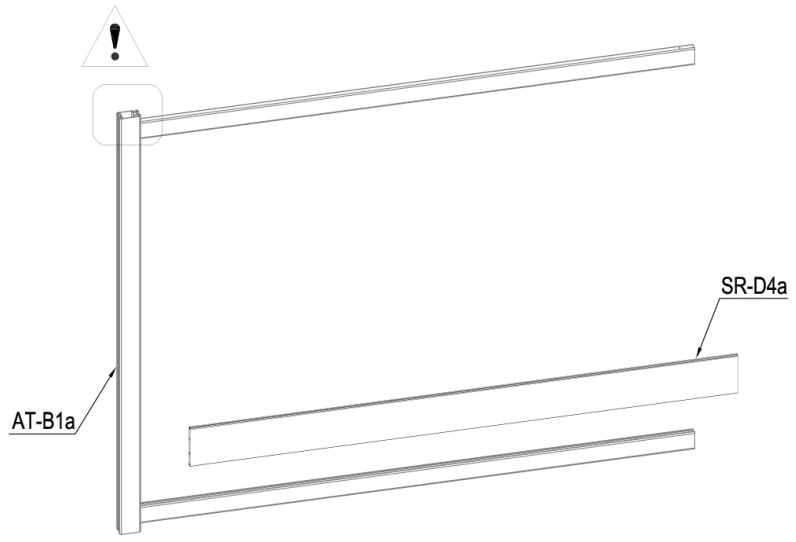

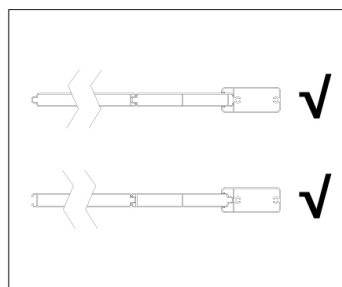
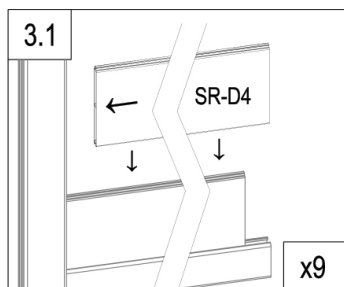
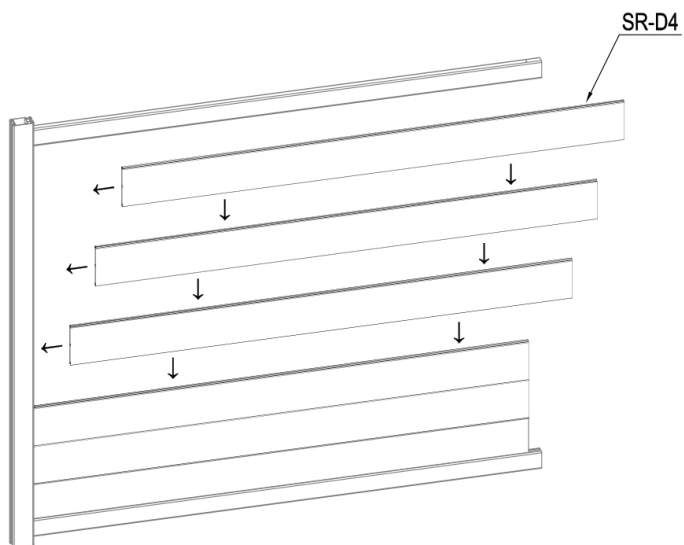

	SR-D4a	1
---	--------	---

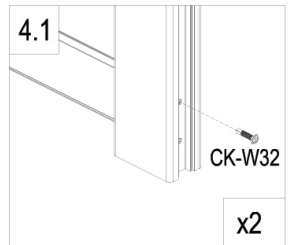
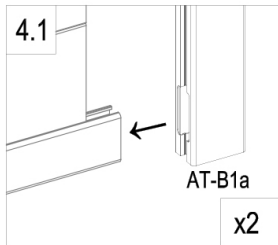
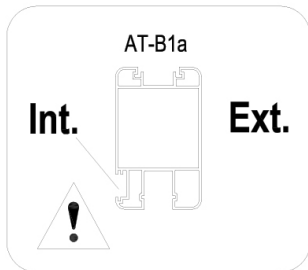
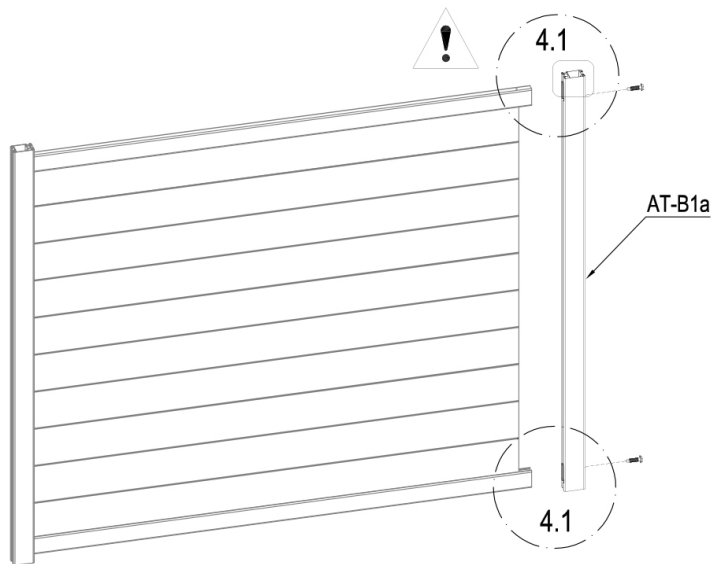

	SR-D4	9
---	-------	---



	AT-B1a	1
	CK-W32	2

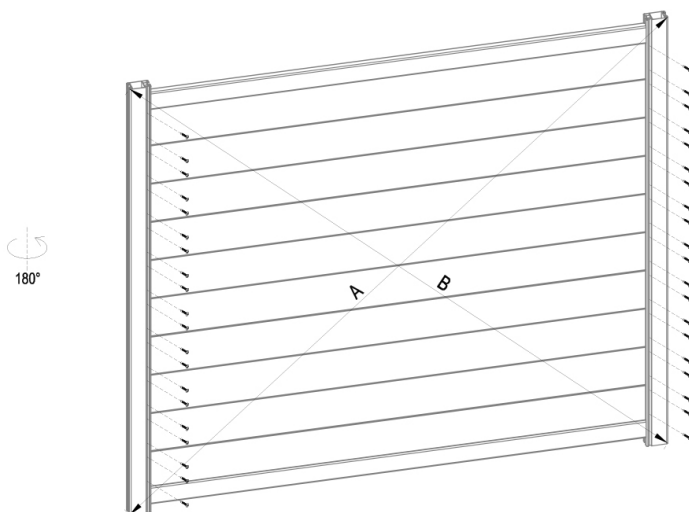

A=B

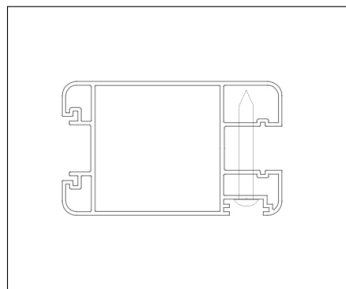
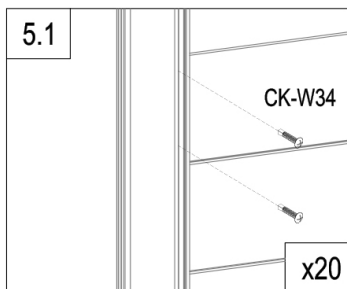



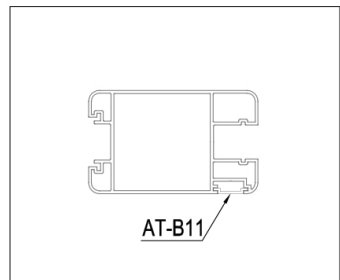
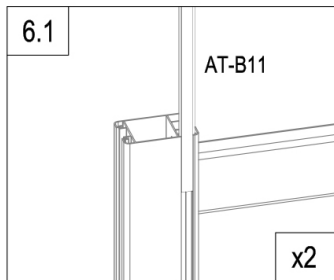
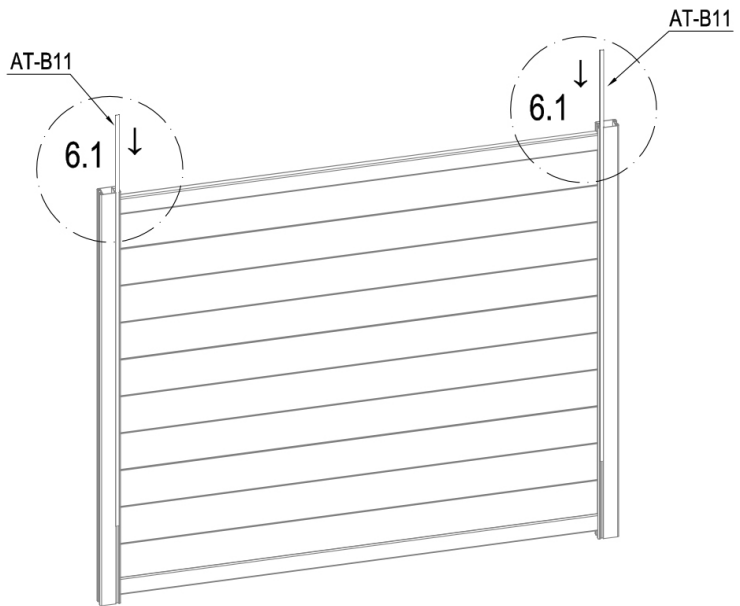

	CK-W34	40
---	--------	----

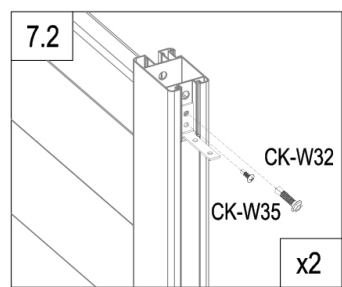
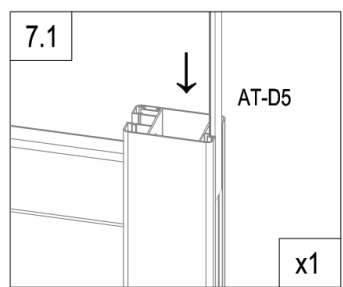
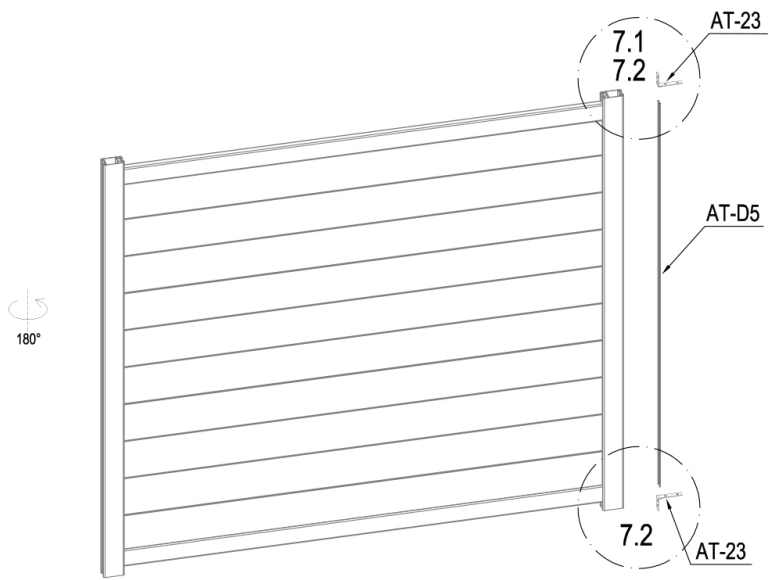





	AT-B11	2
---	--------	---

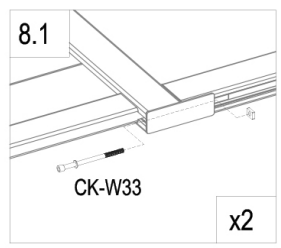
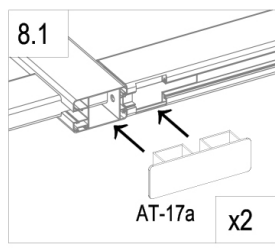
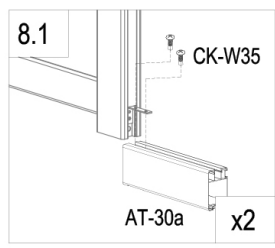
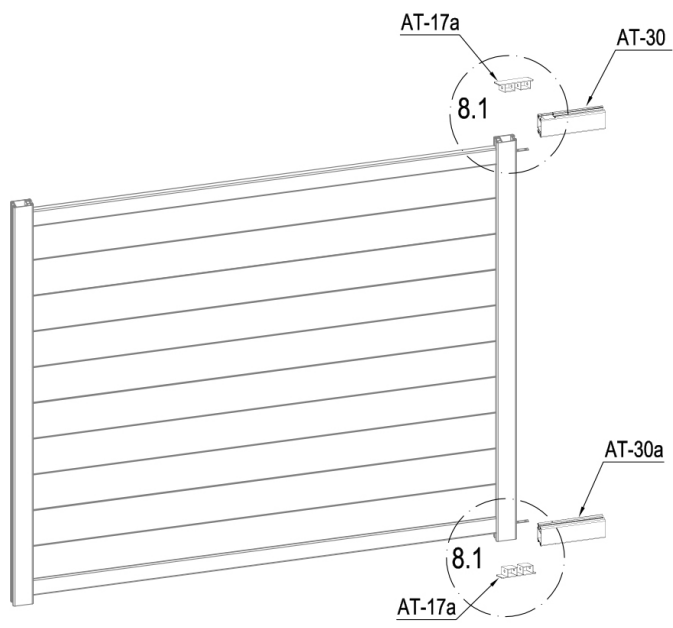





	AT-D5	1
	AT-23	2
	CK-W32	2
	CK-W35	2



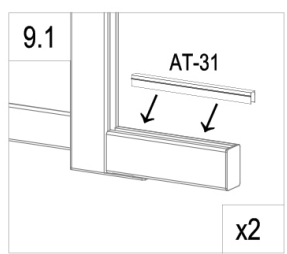
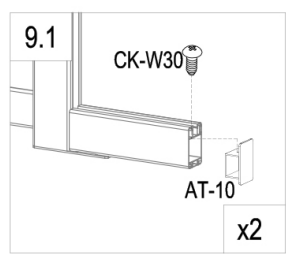
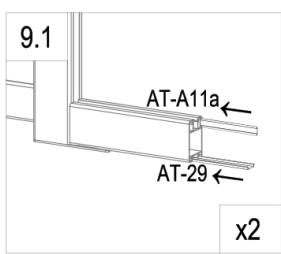
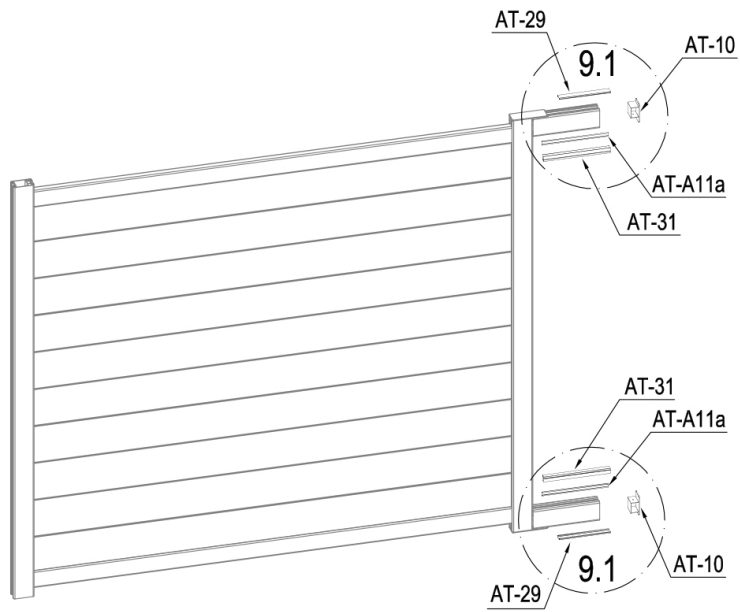

	AT-30	1
	AT-30a	1
	AT-17a	2

	CK-W33	2
	CK-W35	4





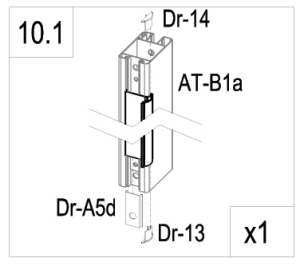
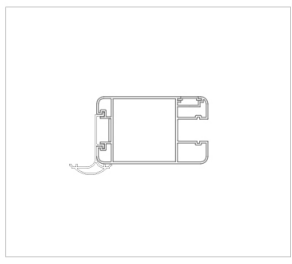
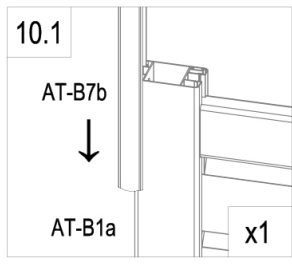
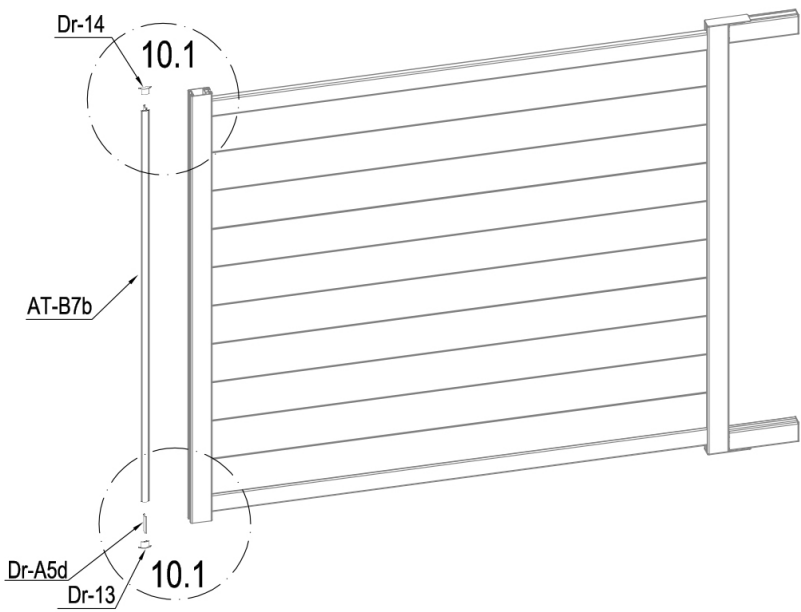

	AT-29	2
	AT-A11a	2
	AT-31	2

	AT-10	2
	CK-W30	2

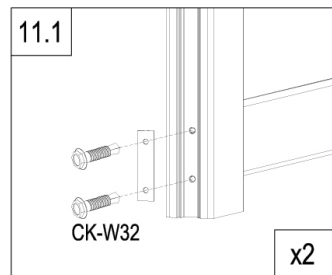
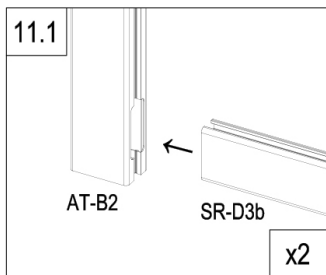
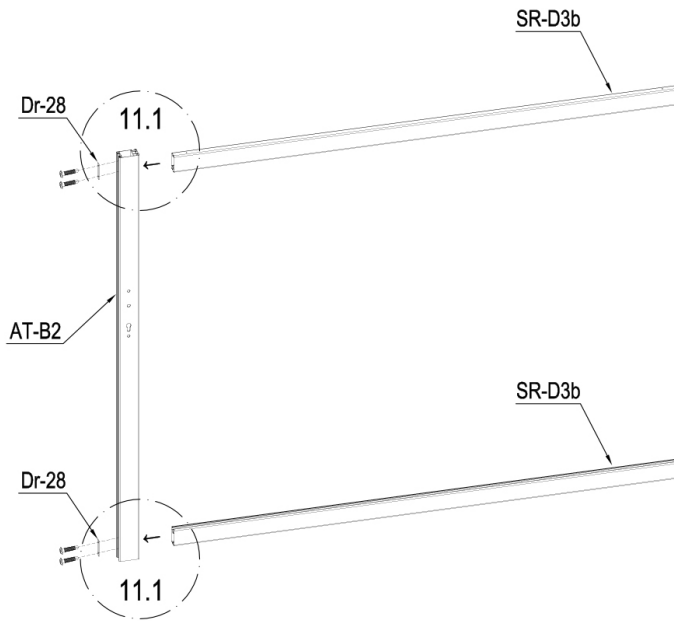

	AT-B7b	1
	Dr-A5d	1
	Dr-13	1
	Dr-14	1



	AT-B2	1
	SR-D3b	2
	Dr-28	2
	CK-W32	4

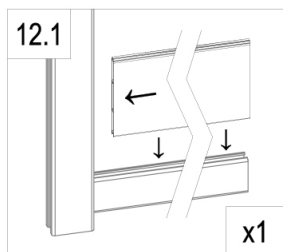
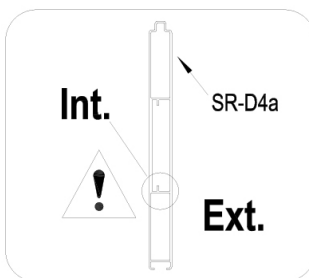
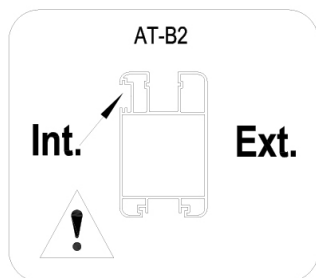
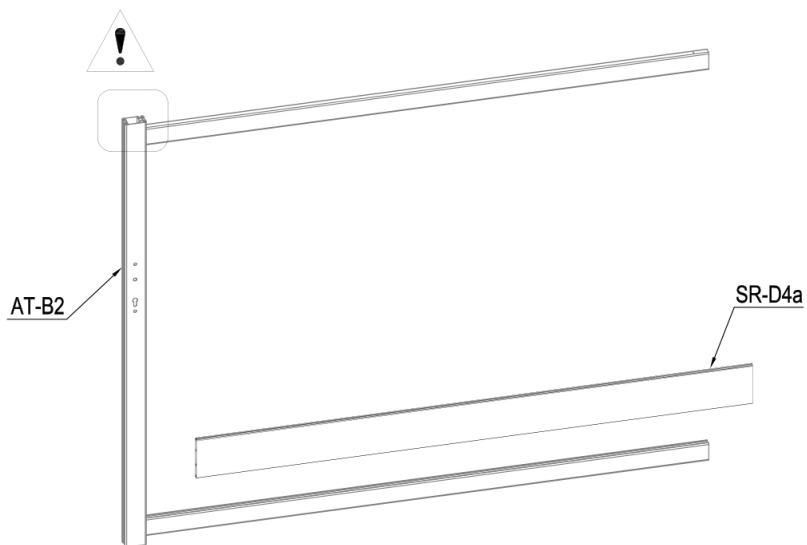

	SR-D4a	1
--	--------	---

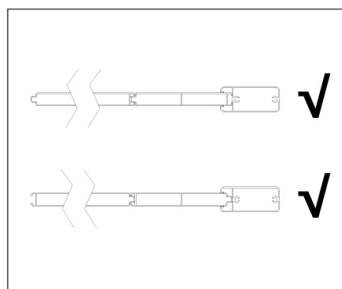
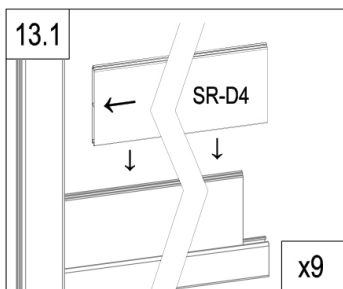
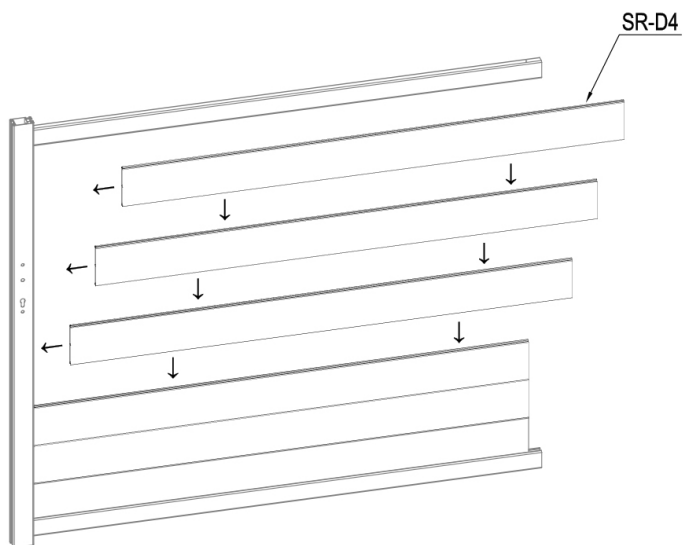

	SR-D4	9
---	-------	---

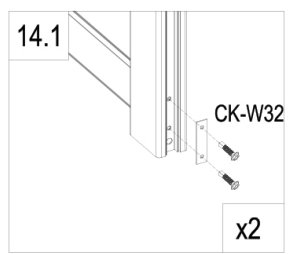
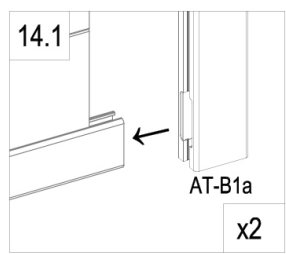
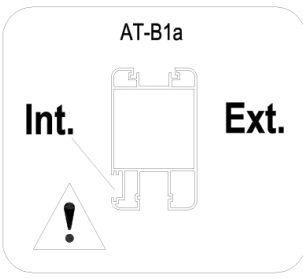
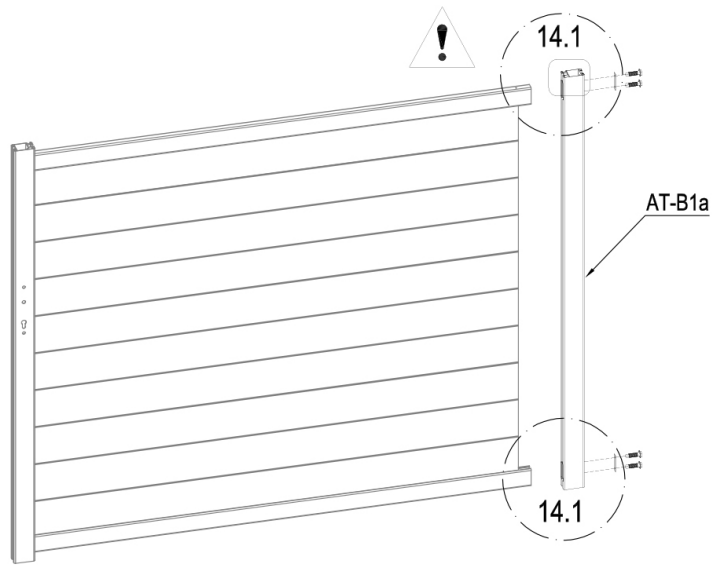

	AT-B1a	1
	Dr-28	2
	CK-W32	4

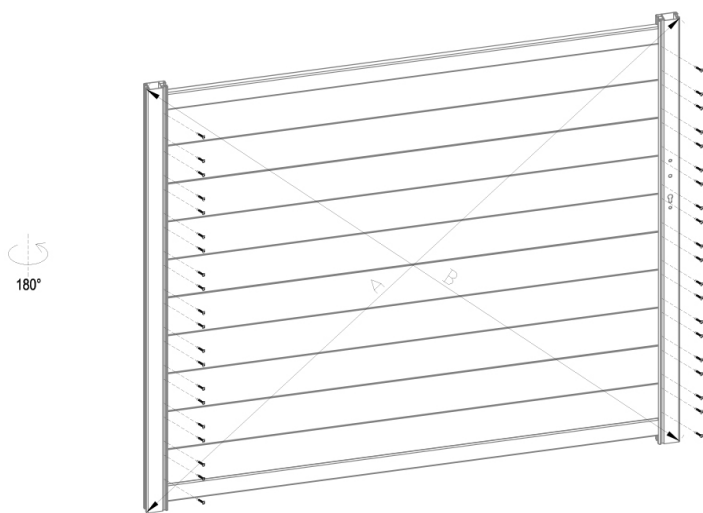

A=B

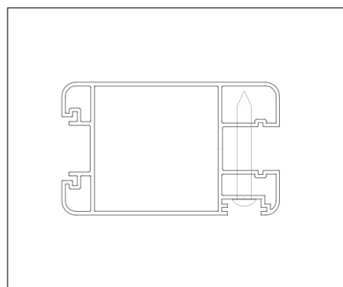
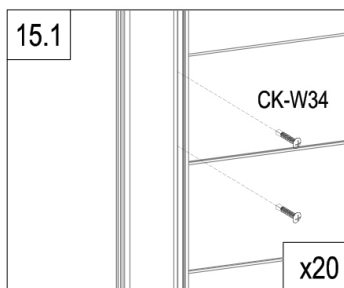

	CK-W34	40
---	--------	----

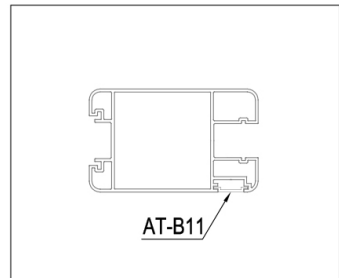
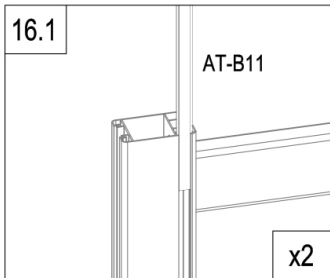
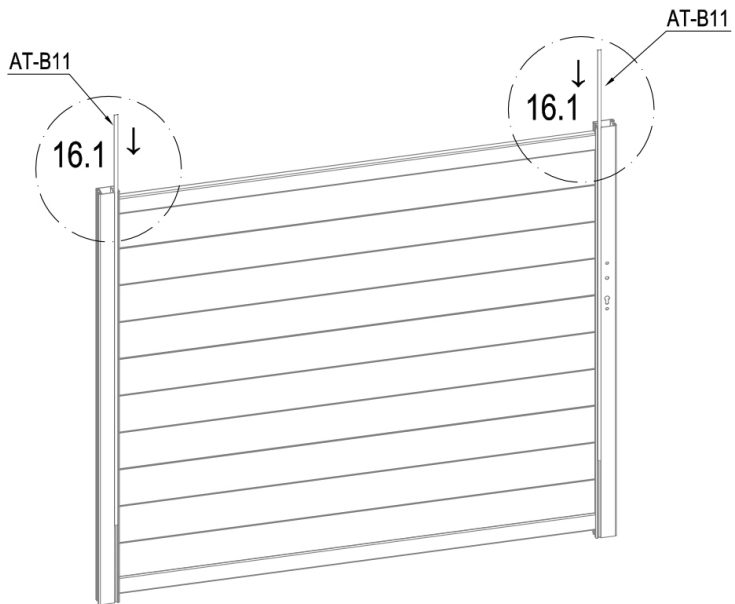

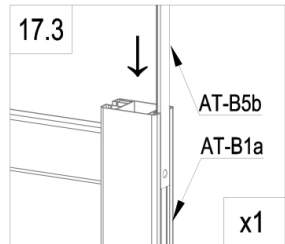
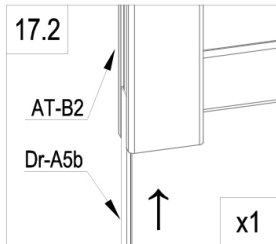
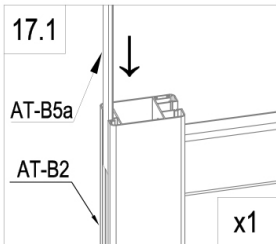
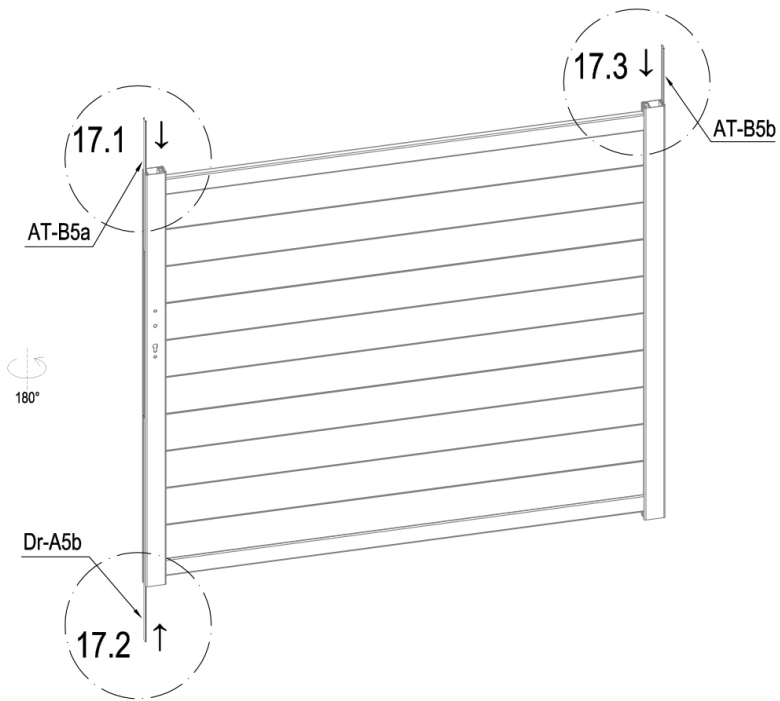

	AT-B11	2
---	--------	---



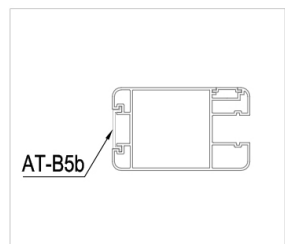

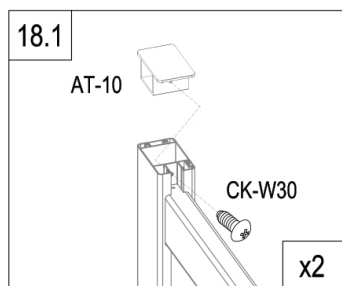
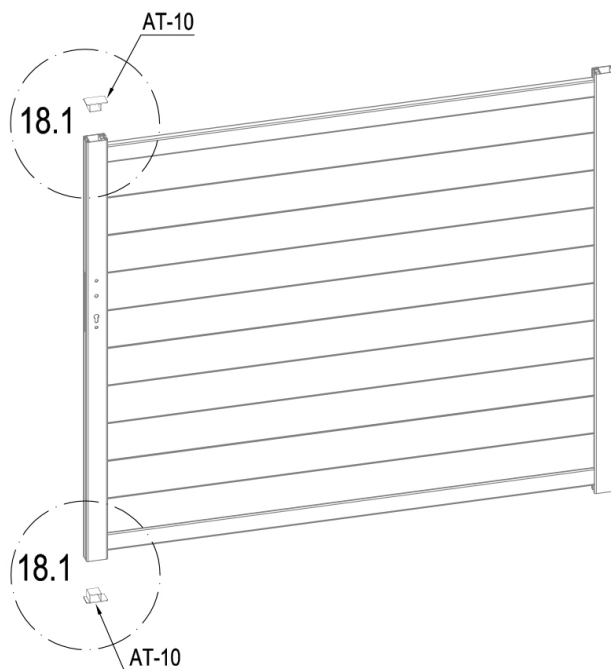
	AT-B5b	1
	AT-B5a	1
	Dr-A5b	1



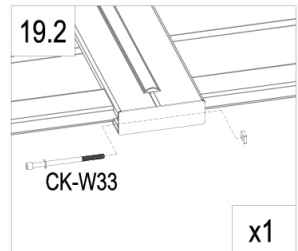
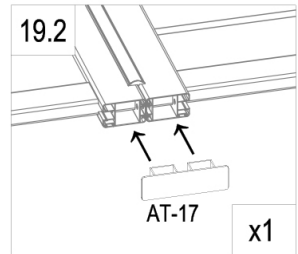
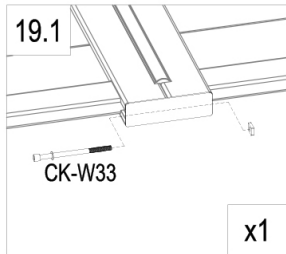
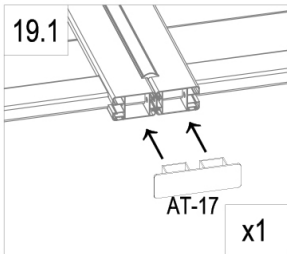
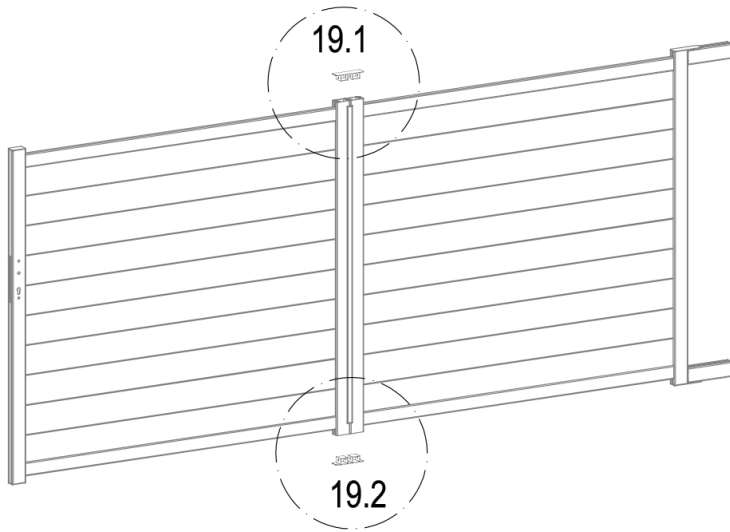

	AT-10	2
	CK-W30	2



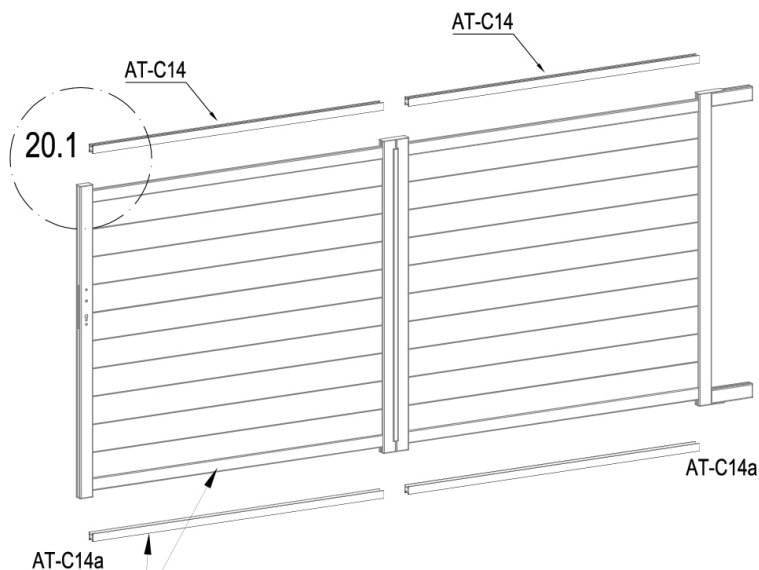

	AT-17	2
	CK-W33	2

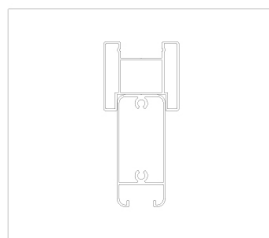
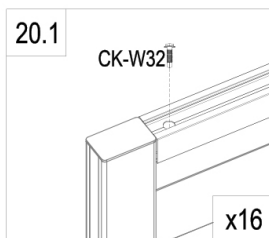
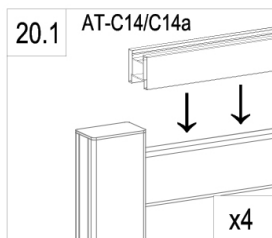

EN: These parts are made for connecting your gate's automation
 FR: Ces pièces sont faites pour relier l'automatisation de votre portail
 DE: Diese Teile sind für den Anschluss der Automatisierung Ihres Tores vorgesehen
 ES: Estas piezas están hechas para conectar la automatización de su puerta
 PT: Estas peças são feitas para ligar a automatização do seu portão
 IT: Queste parti sono realizzate per collegare l'automazione del vostro cancello
 NL: Deze onderdelen zijn gemaakt voor het aansluiten van de automatisering van uw poort.
 PL: Te części są wykonane do podłączenia automatyki bramy.



	AT-C14	2
	AT-C14a	2
	CK-W32	16

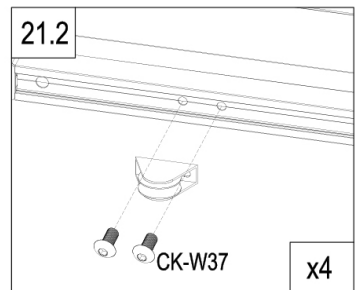
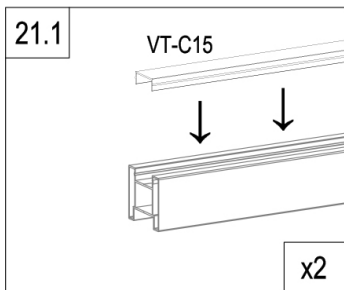
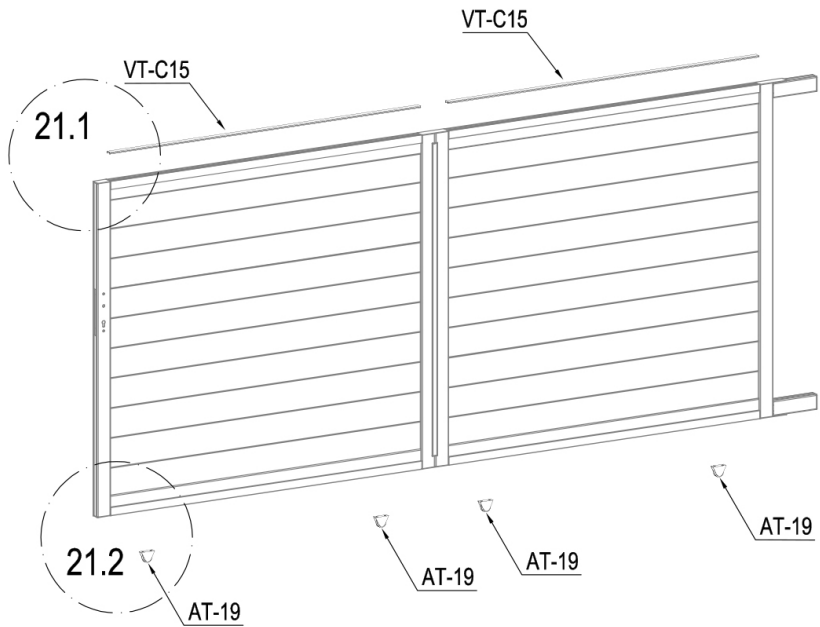

	VT-C15	2
	AT-19	4
	CK-W37	8

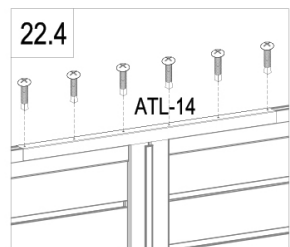
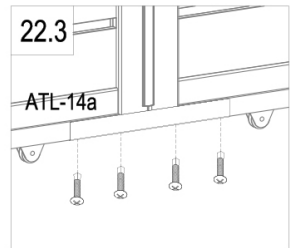
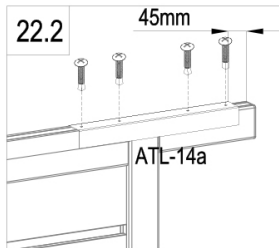
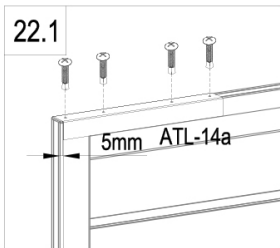
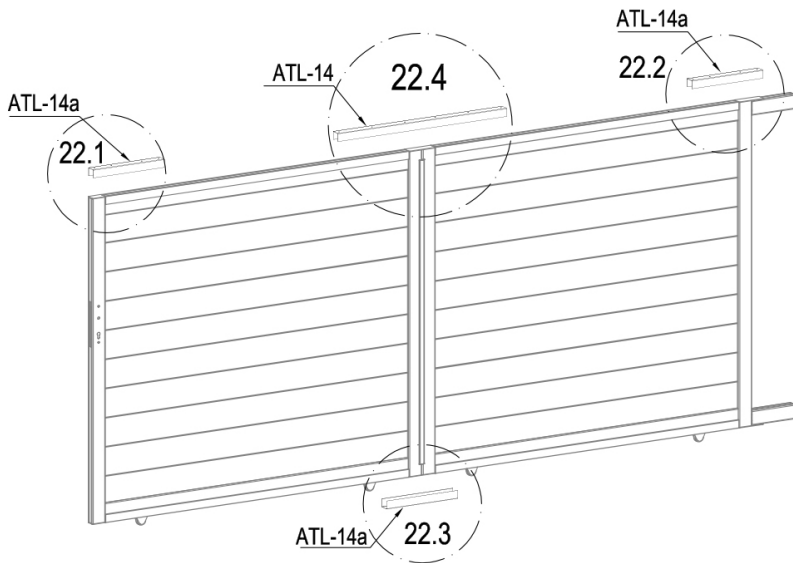

	ATL-14	1
	ATL-14a	3
	CK-W34	18

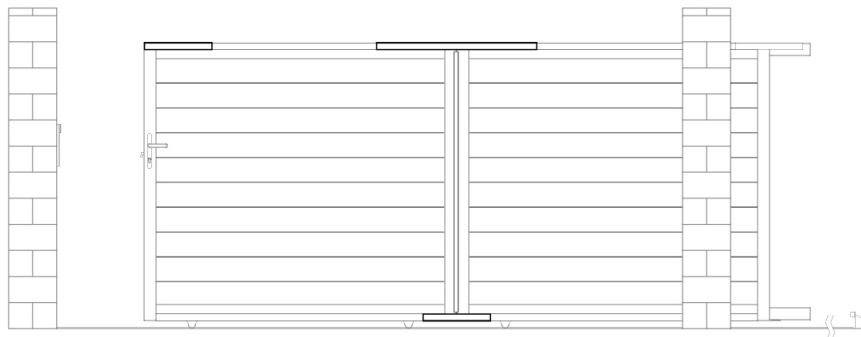

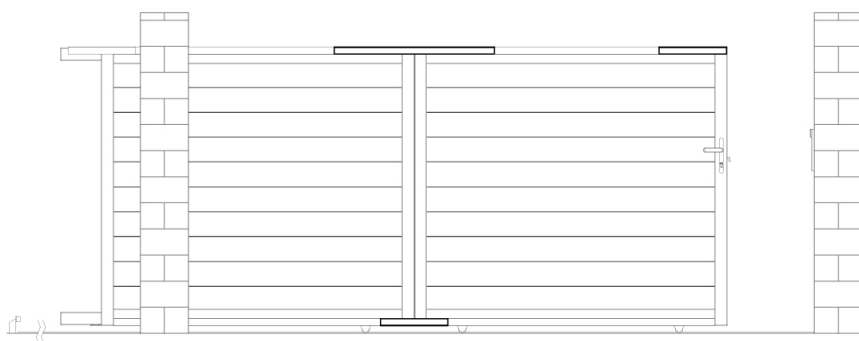

L : P23~28

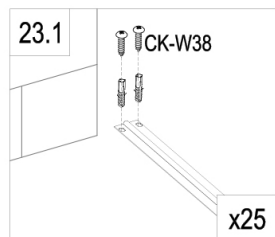
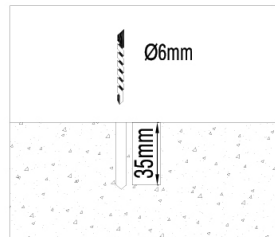
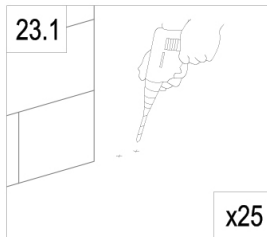
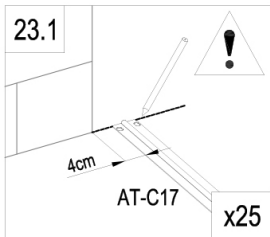
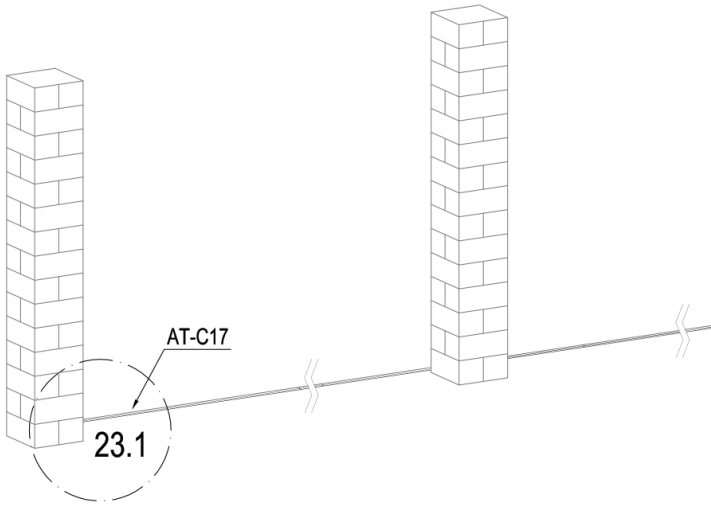

R : P29~34

L



	AT-C17	5
	CK-W38	50

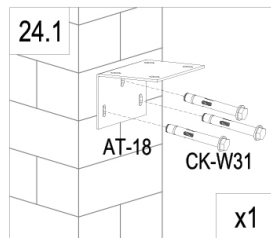
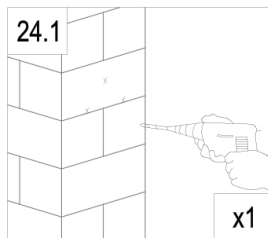
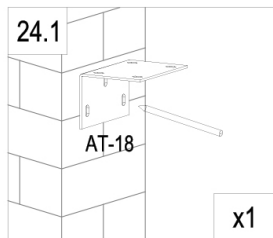
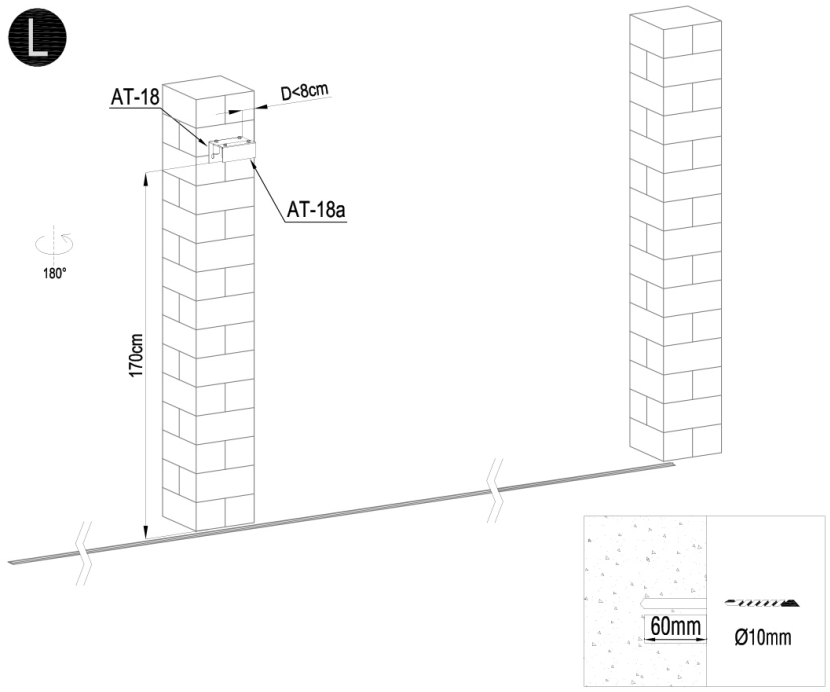

	AT-18	1
	AT-18a	1
	AT-20	4
	CK-W31	3

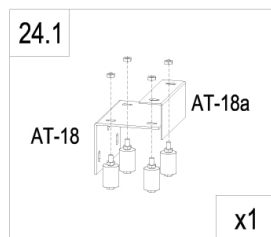
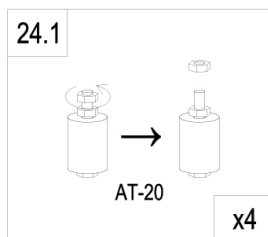



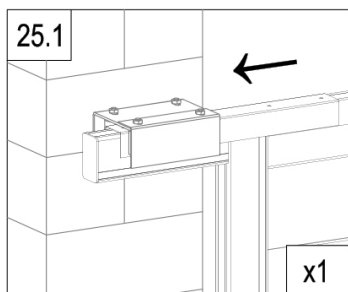
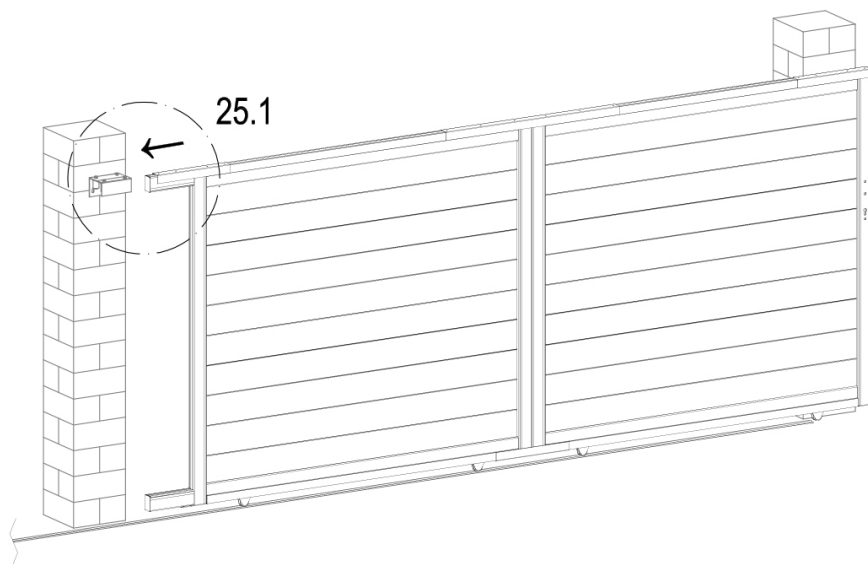



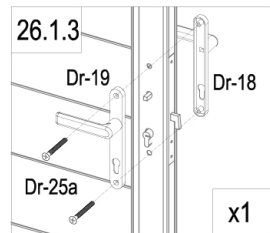
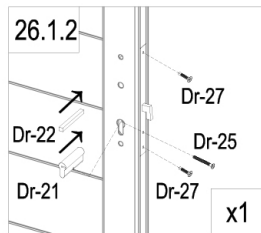
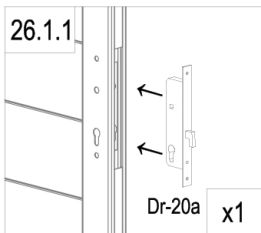
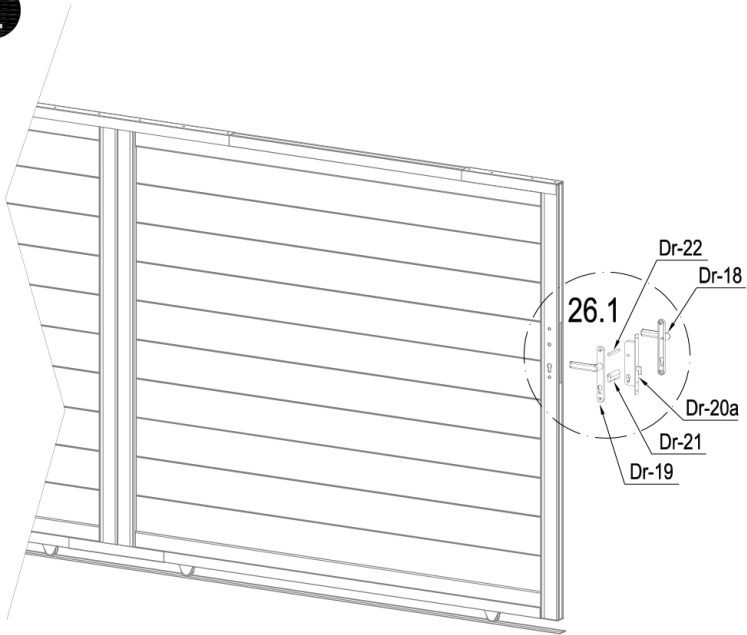

L



L



	Dr-20a	1
	Dr-21	1
	Dr-22	1
	Dr-25	1

	Dr-18	1
	Dr-19	1
	Dr-25a	2
	Dr-27	2

L

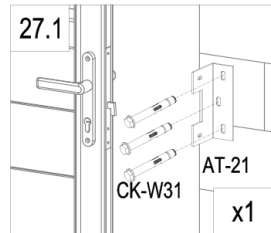
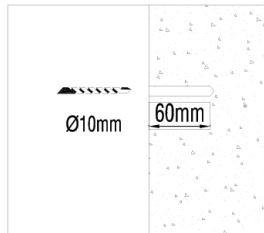
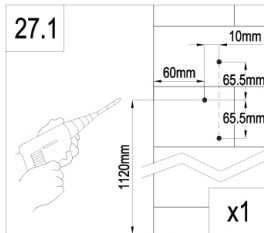
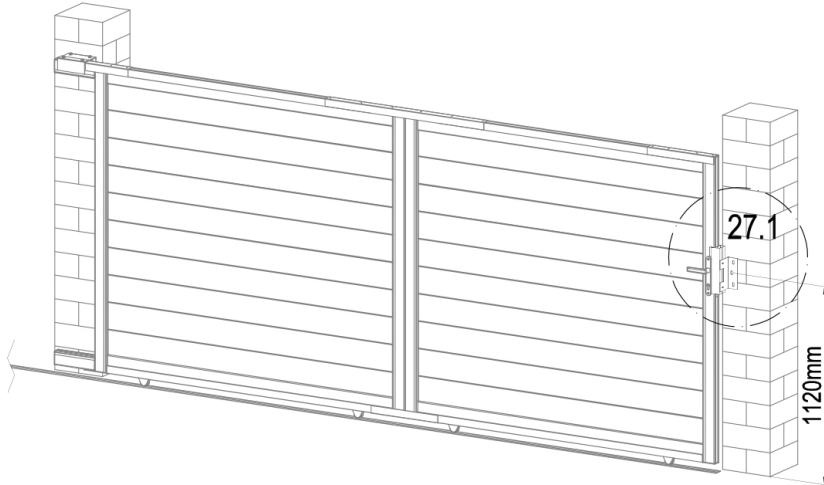

	AT-16	1
	AT-21	1
	CK-W36	2
	CK-W31	3
	AT-22J	3

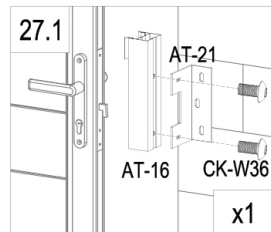
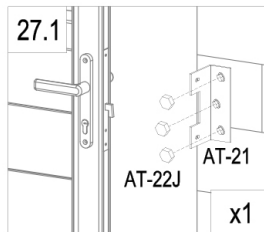

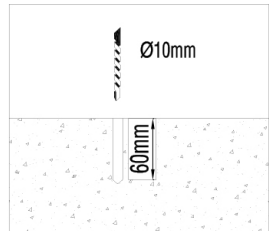
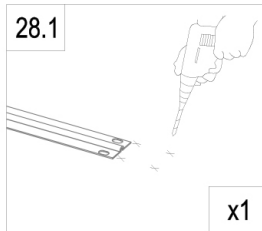
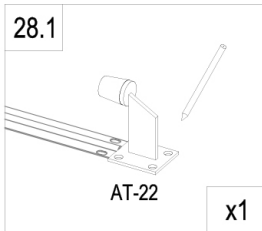
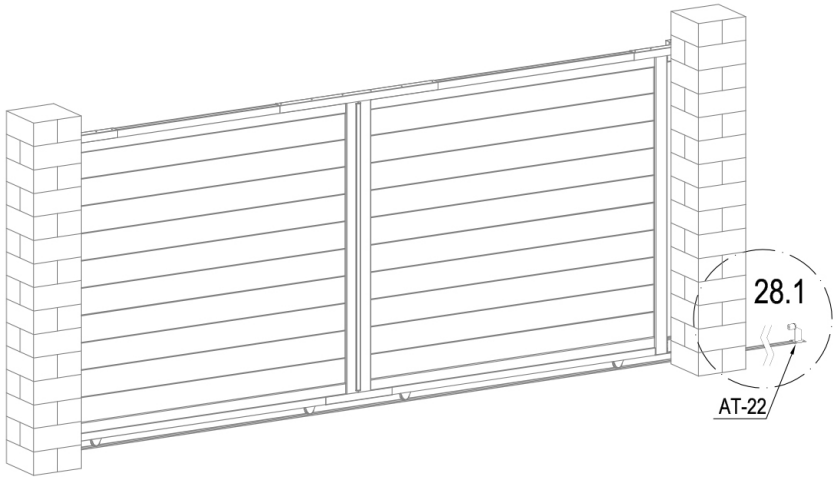

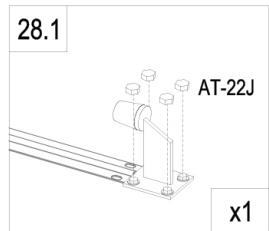
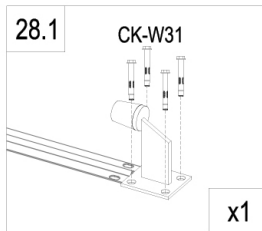

	AT-22	1
	CK-W31	4
	AT-22J	4

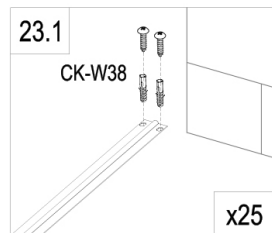
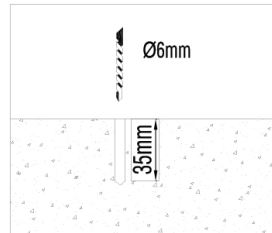
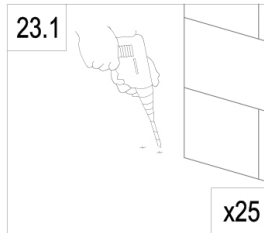
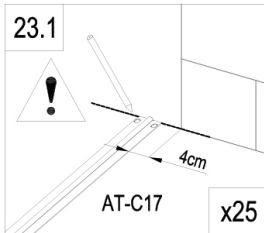
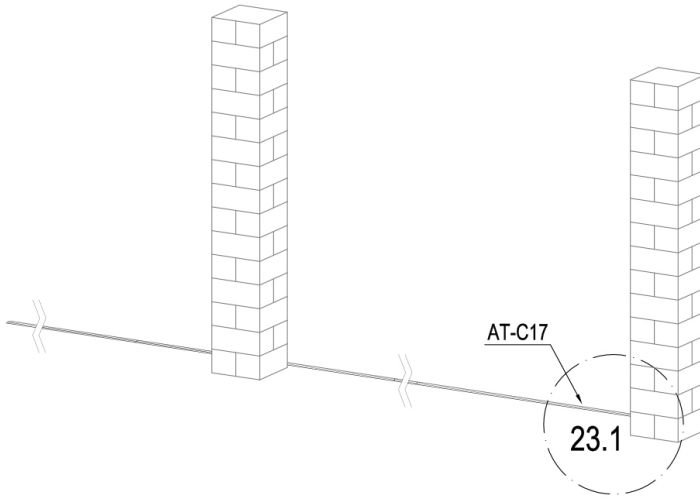

R



	AT-C17	5
	CK-W38	50

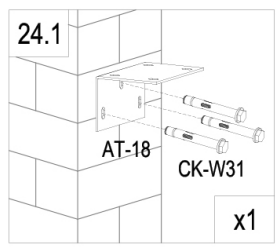
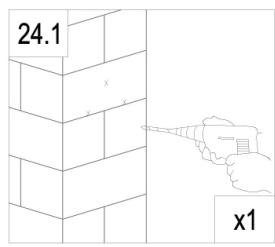
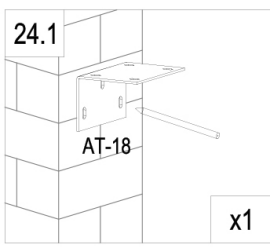
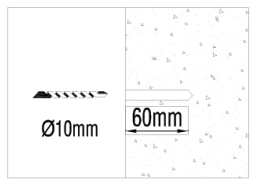
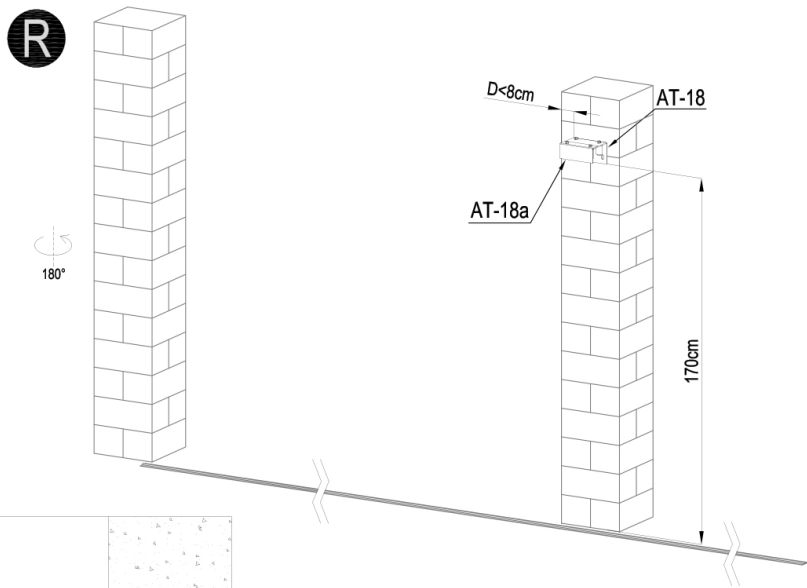

	AT-18	1
	AT-18a	1
	AT-20	4
	CK-W31	3

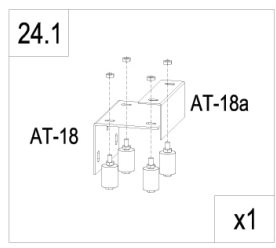
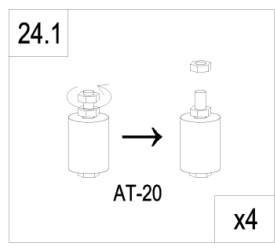

R

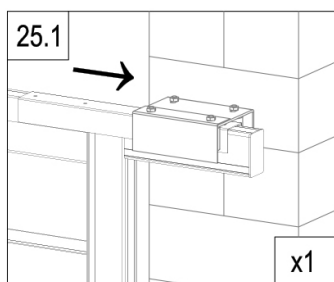
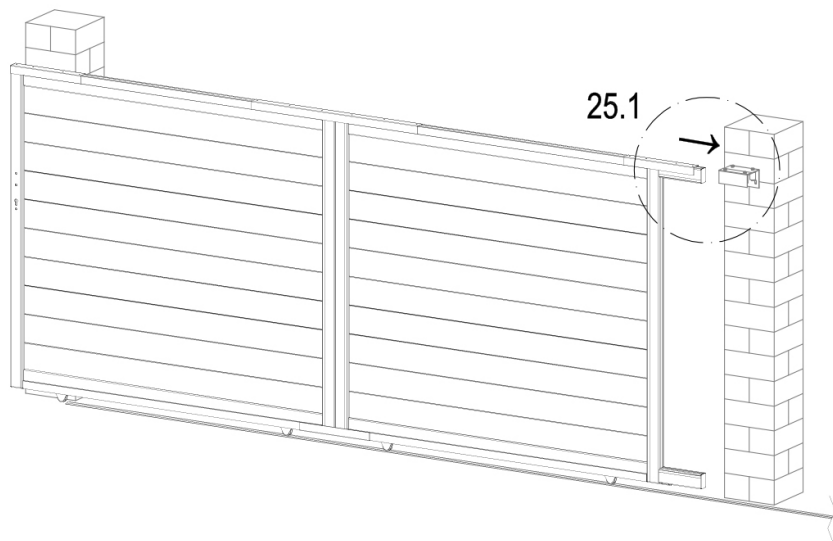

R

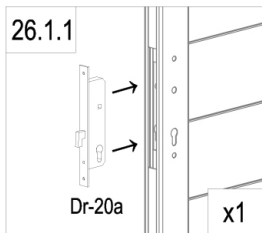
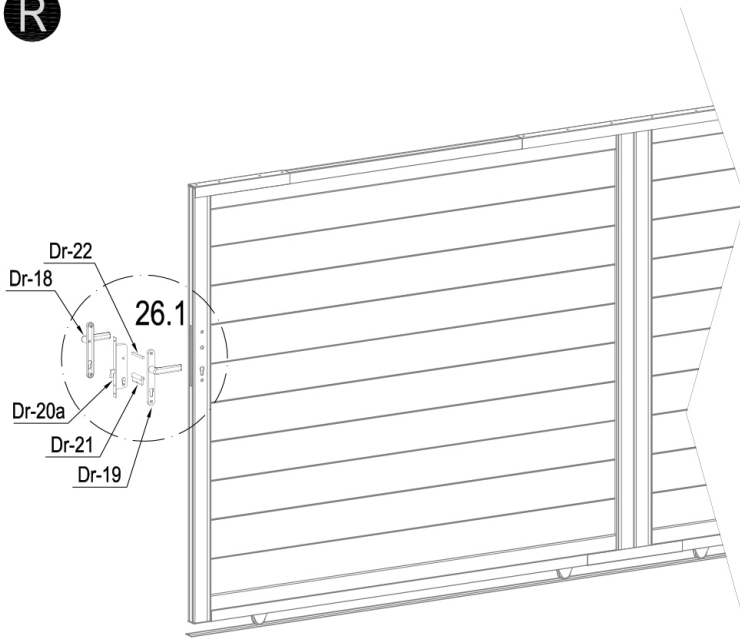

	Dr-20a	1
	Dr-21	1
	Dr-22	1
	Dr-25	1

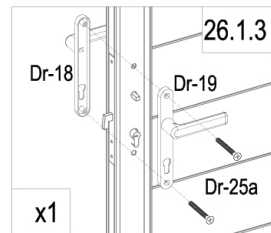
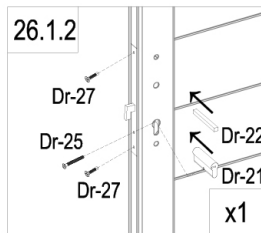

	Dr-18	1
	Dr-19	1
	Dr-25a	2
	Dr-27	2

R

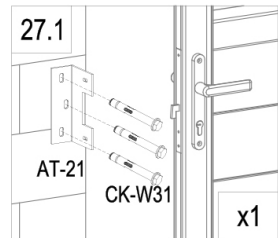
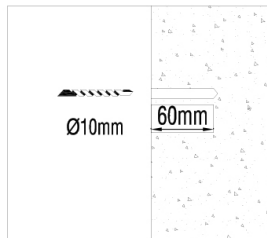
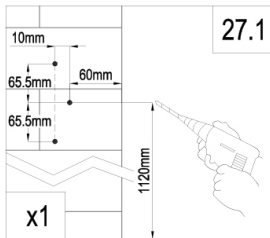
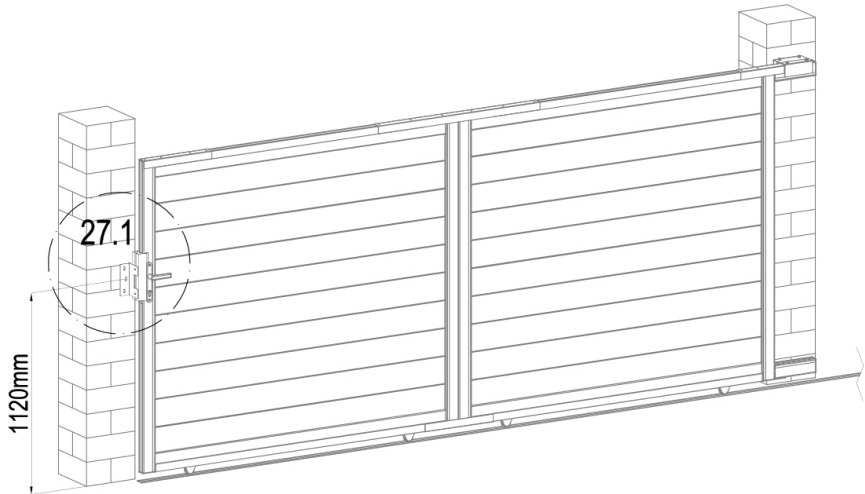

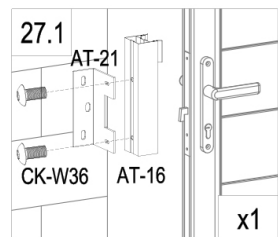
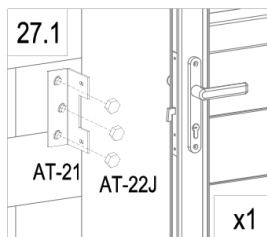

	AT-16	1
	AT-21	1
	CK-W36	2
	CK-W31	3
	AT-22J	3

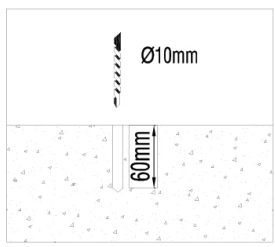
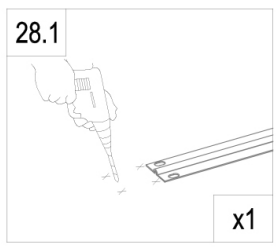
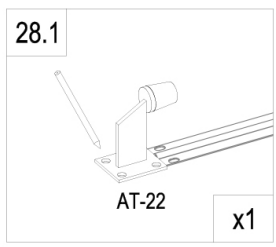
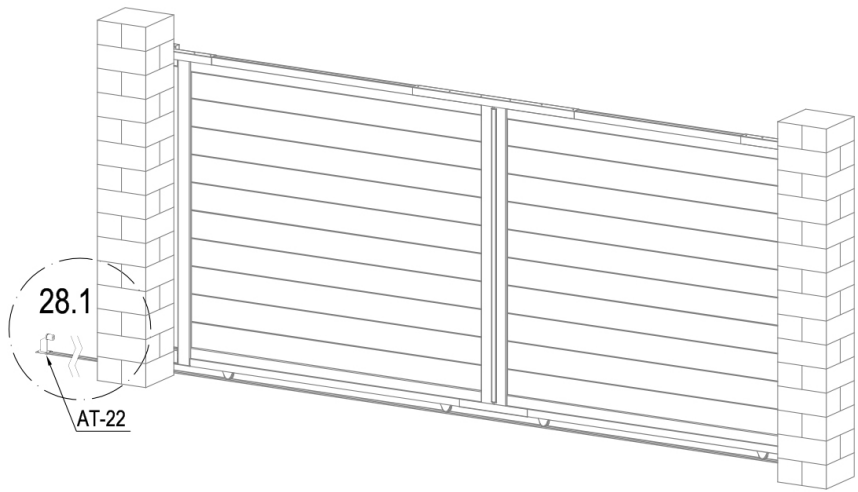

R



	AT-22	1
	CK-W31	4
	AT-22J	4

