

CASANOVO

SUNNY 400C180

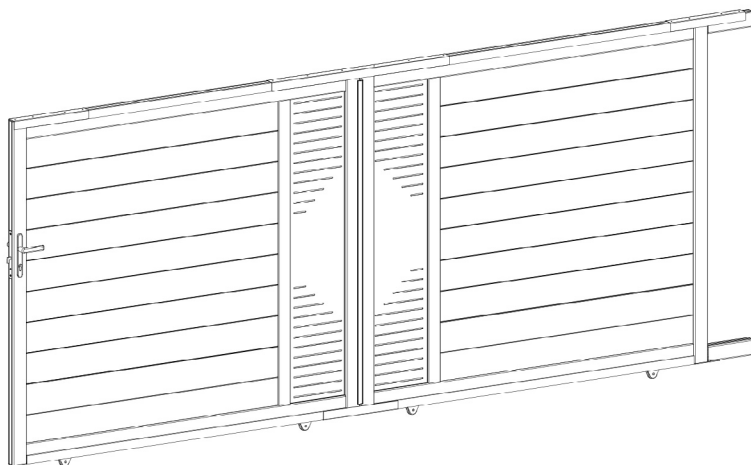

COM-000186 [x1]

COM-000188 [x1]

COM-000187 [x1]

COM-000282 [x1]



7-8H



X 2



INSTRUCTION MANUAL / NOTICE DE MONTAGE / MONTAGEANLEITUNG / MANUAL DE MONTAJE / MANUAL DE MONTAGEM / MANUALE DI MONTAGGIO /
MONTAGEHANDLEIDING / INSTRUKCJA MONTAŻU / KÄYTTÖOHJEET / BRUKSANVISNING / BRUGSANVISNING / INSTRUCIUNI DE ASAMBLARE /
NAVODILA ZA SESTAVLJANJE / NÁVOD NA MONTÁŽ / ÖSSZESZERELÉSI ÚTMUTATÓ / NÁVOD K MONTÁŽI / UPUTE ZA INSTALACIJU /
ΟΔΗΓΙΕΣ ΣΥΝΑΡΜΟΛΟΓΗΣΗΣ / SURINKIMO INSTRUKCIJOS / MONTĀŽAS INSTRUKCIJAS

Ext.

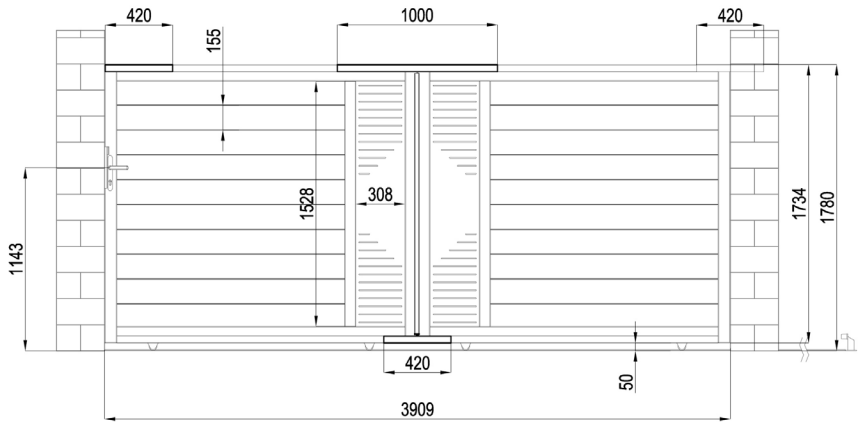

Int.

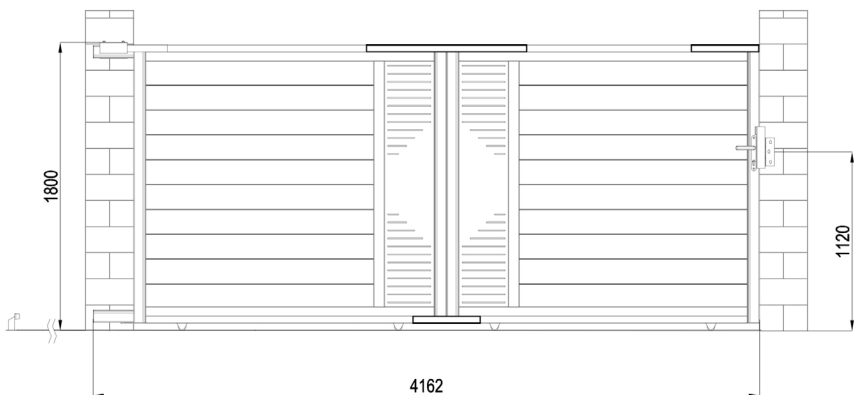



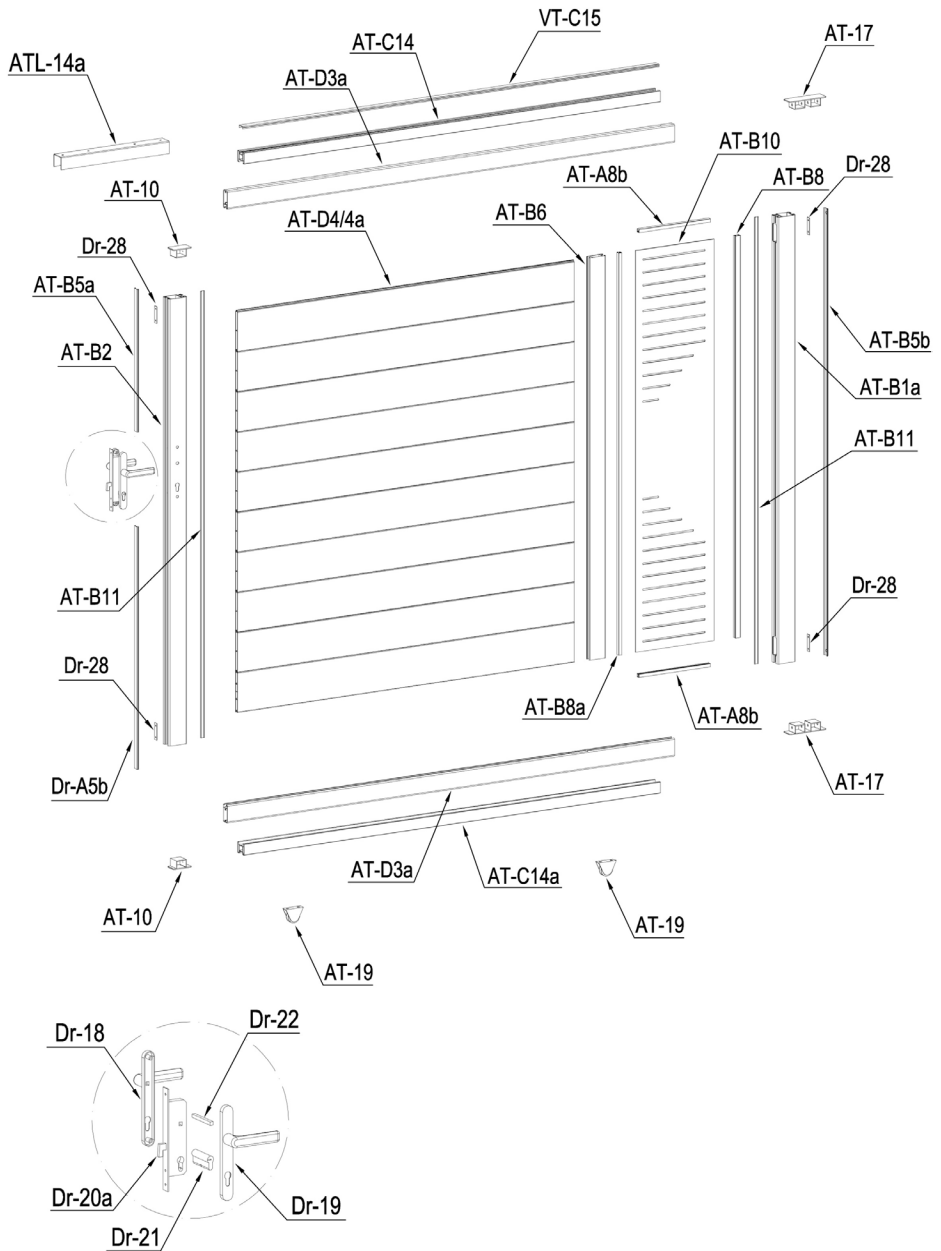

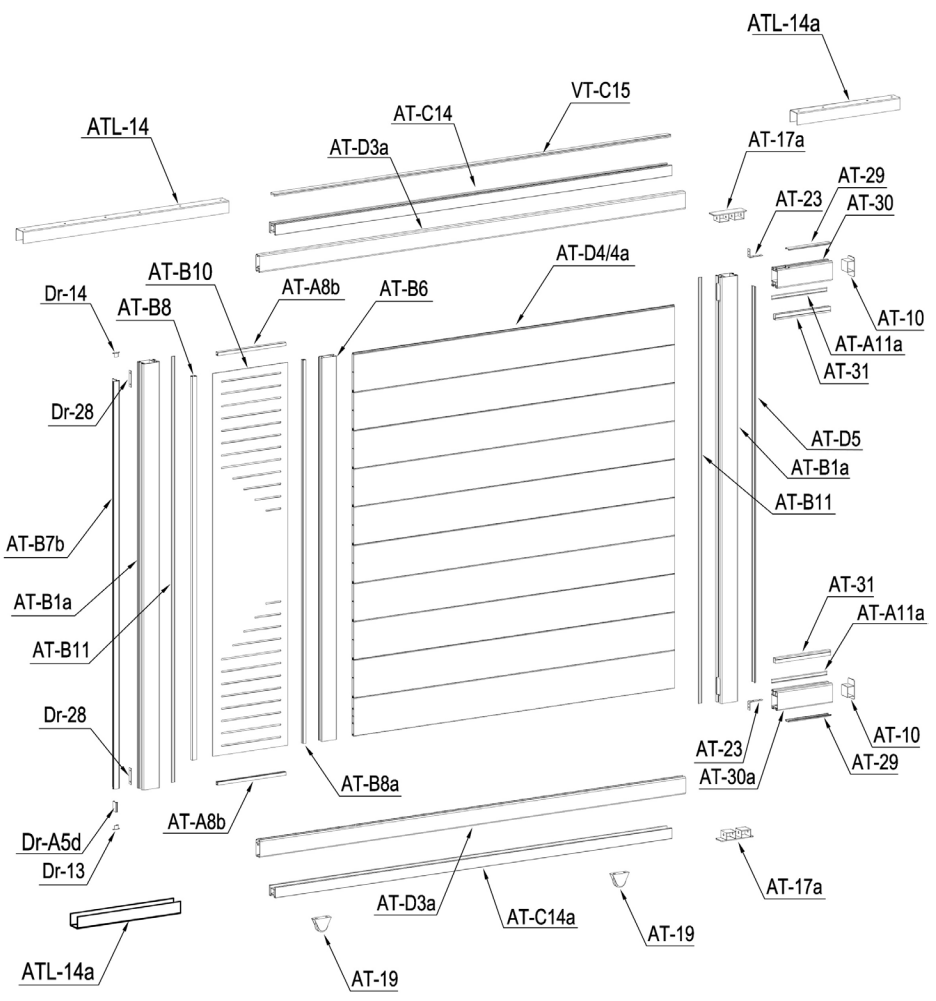

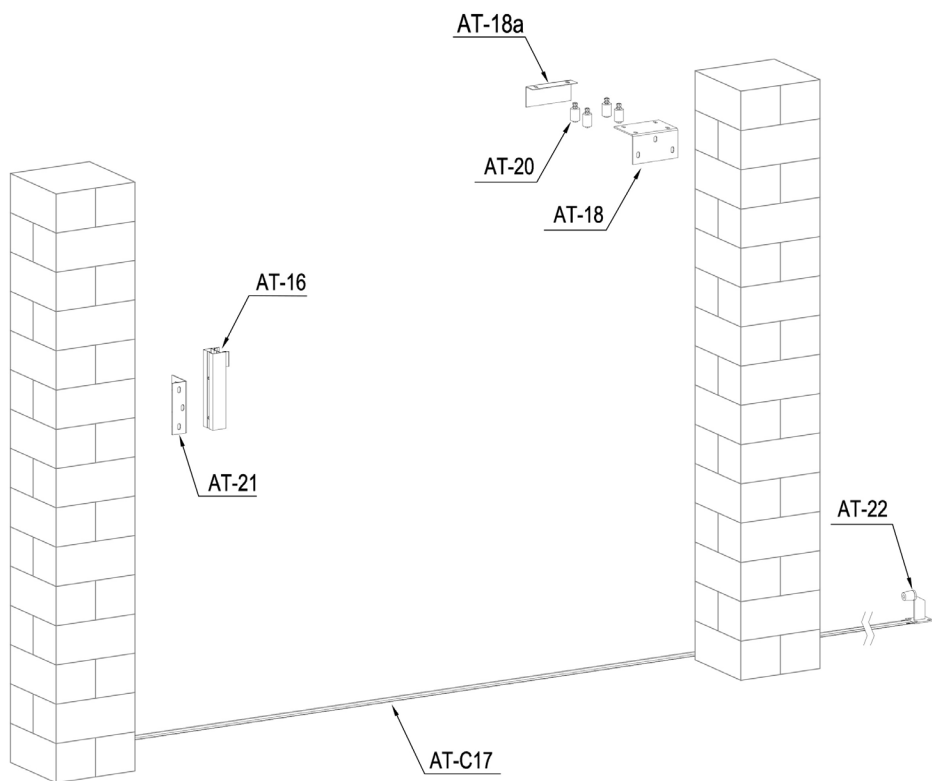





































CASANOVO







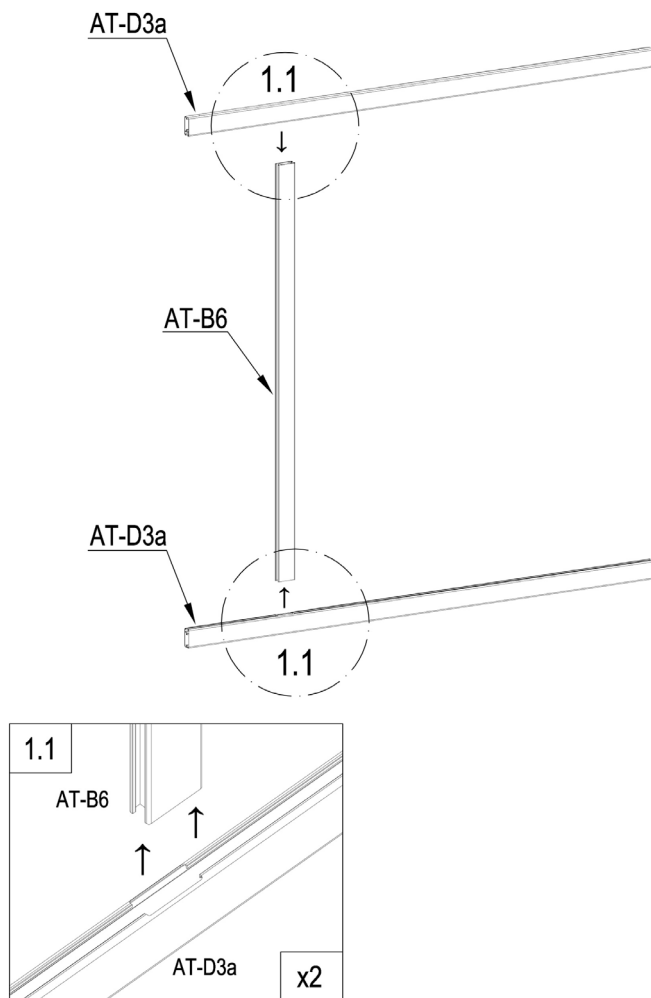

PART LIST

IMAGE	NO.	L.(mm)	QTY	IMAGE	NO.	L.(mm)	QTY
	AT-B1a	1728	3		AT-10		4
	AT-B2	1728	1		Dr-13		1
	AT-30	250	1		Dr-14		1
	AT-30a	250	1		AT-18		1
	AT-D3a	1931	4		AT-18a		1
	AT-D4	1455	18		AT-19		4
	AT-D4a	1455	2		AT-20		4
	AT-D5	1603	1		AT-21		1
	AT-B5a	550.5	1		AT-22		1
	AT-B5b	1728	1		AT-23		2
	Dr-A5b	937	1		Dr-18		1
	AT-29	193	2		Dr-19		1
	Dr-A5d	52	1		Dr-20a		1
	AT-B10	1553	2		Dr-21		1
	AT-B6	1556	2		Dr-22		1
	AT-B8	1555	2		Dr-25		1
	AT-B8a	1555	2		Dr-25a		2
	AT-A8b	308.5	4		Dr-27		2
	AT-B11	1728	4		Dr-28		6
	AT-A11a	250	2		AT-22J		7
	AT-31	250	2		AT-P30		4
	AT-B7b	1623	1		AT-P31		10
	AT-C14	1798	2		AT-P32		32
	AT-C14a	1798	2		AT-P33		4
	VT-C15	1797	2		AT-P34		87
	AT-16	260	1		AT-P35		6
	AT-C17	1580	5		AT-P36		2
	ATL-14	1000	1		AT-P37		8
	ATL-14a	420	3		AT-P38		50
	AT-17		2		AT-P39		8
	AT-17a		2				



	AT-B6	1
	AT-D3a	2

EN :you can flip and switch the direction of this plate to personalize your gate
 FR: vous pouvez retourner et changer la direction de cette plaque pour personnaliser votre portail
 DE: Sie können dieses Schild umdrehen und die Richtung wechseln, um Ihr Tor zu personalisieren.
 ES: puedes girar y cambiar la dirección de esta placa para personalizar tu puerta
 PT: pode virar e mudar a direção desta placa para personalizar o seu portão
 IT: potete capovolgere e cambiare la direzione di questa piastra per personalizzare il vostro cancello
 NL: u kunt de richting van deze plaat omdraaien en veranderen om uw poort te verpersoonlijken...

PL: można obrócić i przeloczyć kierunek tej płyty, aby spersonalizować bramę.

ES: puedes girar y cambiar la dirección de esta placa para personalizar tu puerta

PT: pode virar e mudar a direção desta placa para personalizar o seu portão

IT: potete capovolgere e cambiare la direzione di questa piastra per personalizzare il vostro cancello

NL: u kunt de richting van deze plaat omdraaien en veranderen om uw poort te verpersoonlijken...

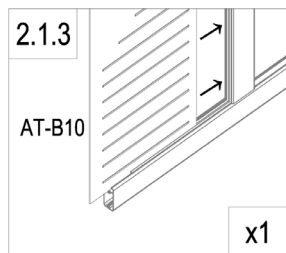
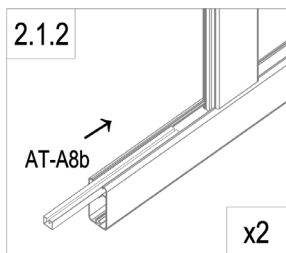
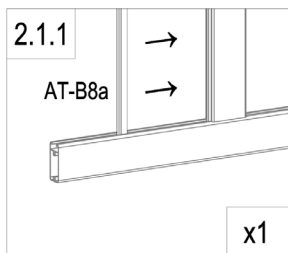
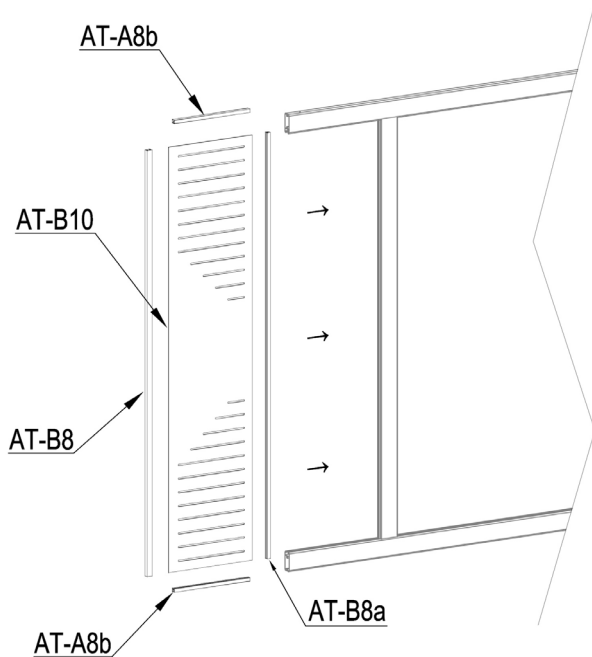

PL: można obrócić i przeloczyć kierunek tej płyty, aby spersonalizować bramę.



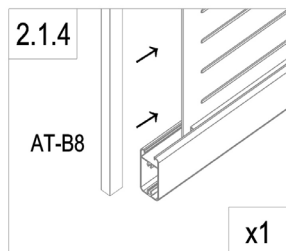

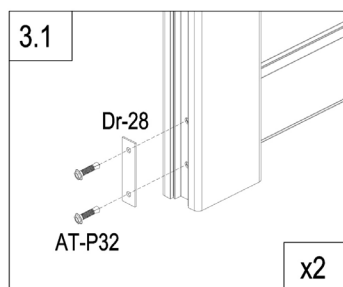
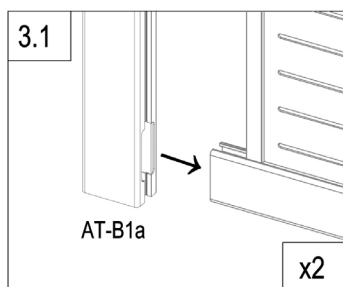
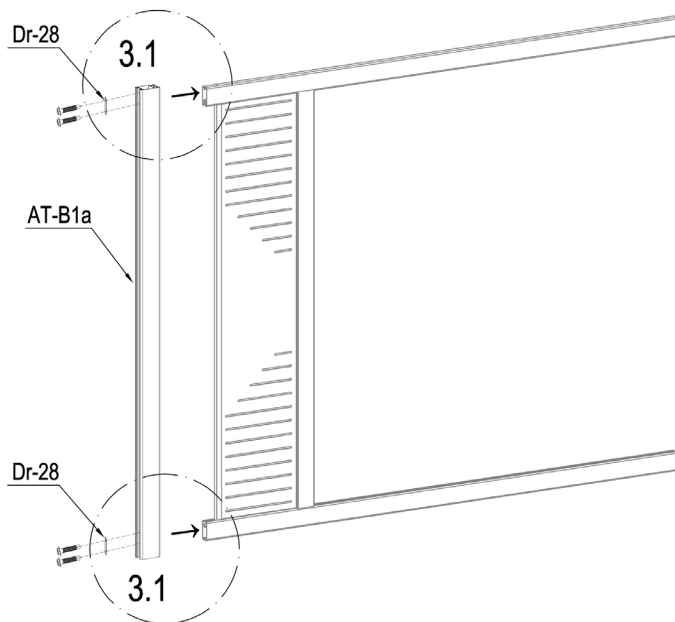
	AT-B8a	1
	AT-A8b	2
	AT-B10	1
	AT-B8	1



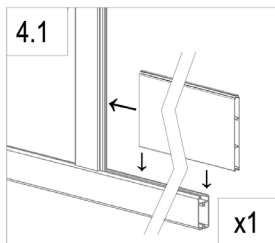
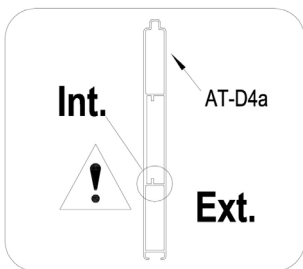
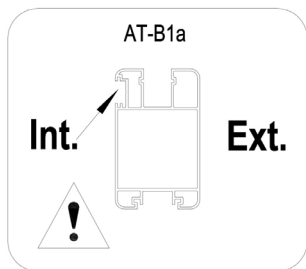
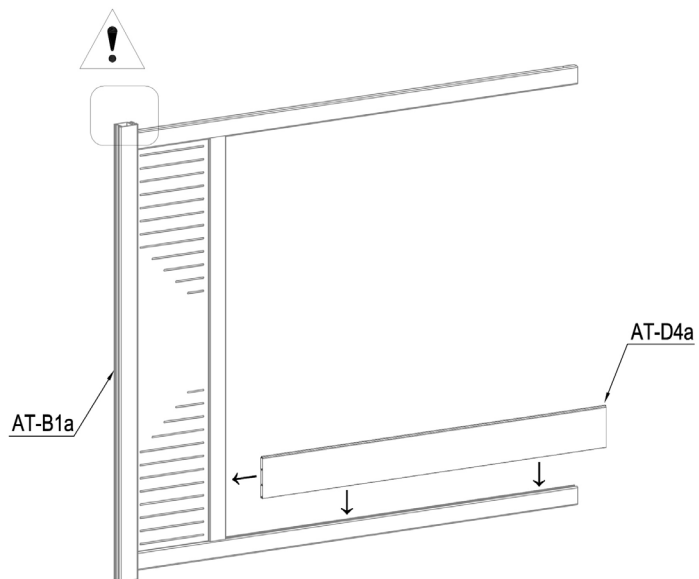

	AT-B1a	1
	Dr-28	2
	AT-P32	4



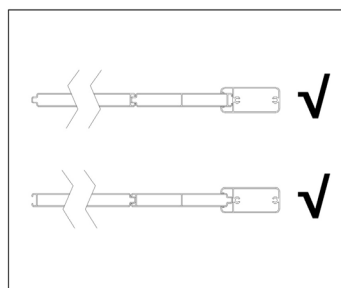
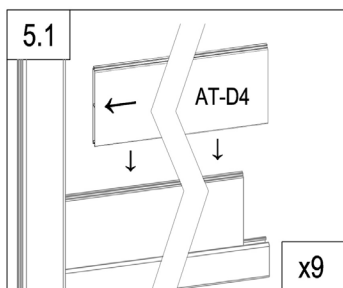
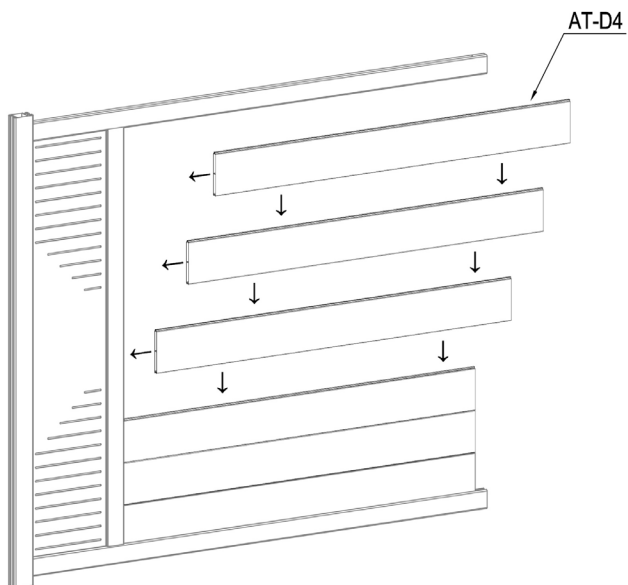

	AT-D4a	1
-------------------------------------------------------------------------------------	--------	---

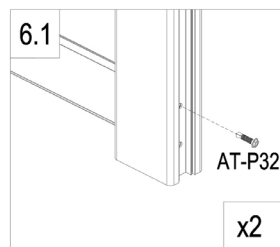
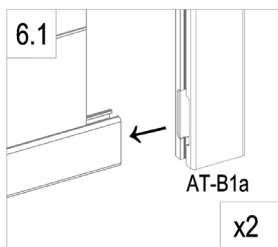
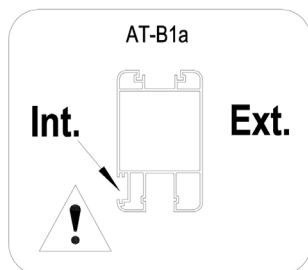
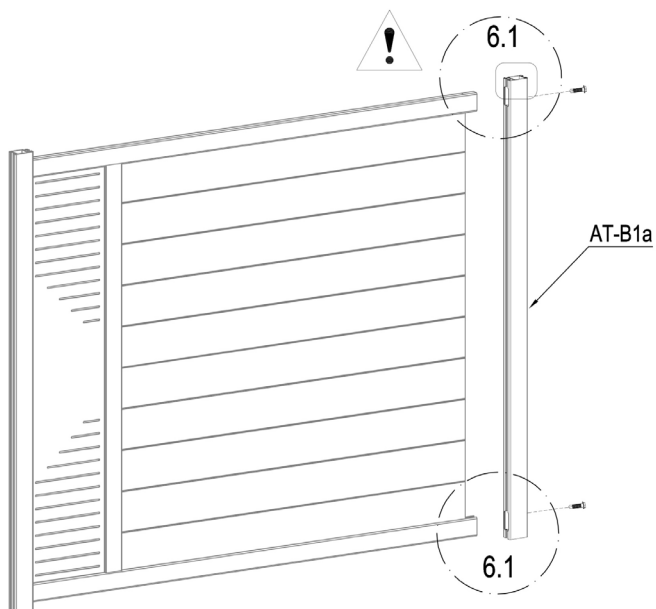

	AT-D4	9
-------------------------------------------------------------------------------------	-------	---



	AT-B1a	1
	AT-P32	2

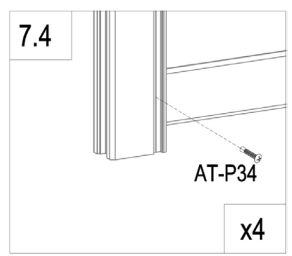
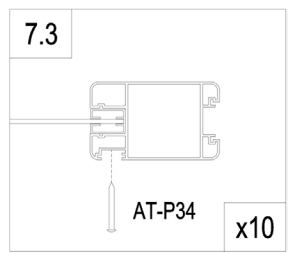
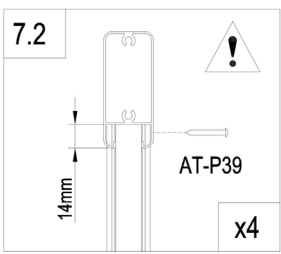
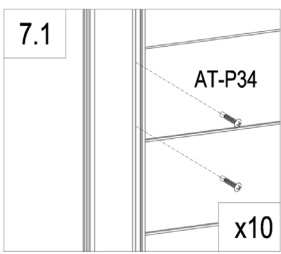
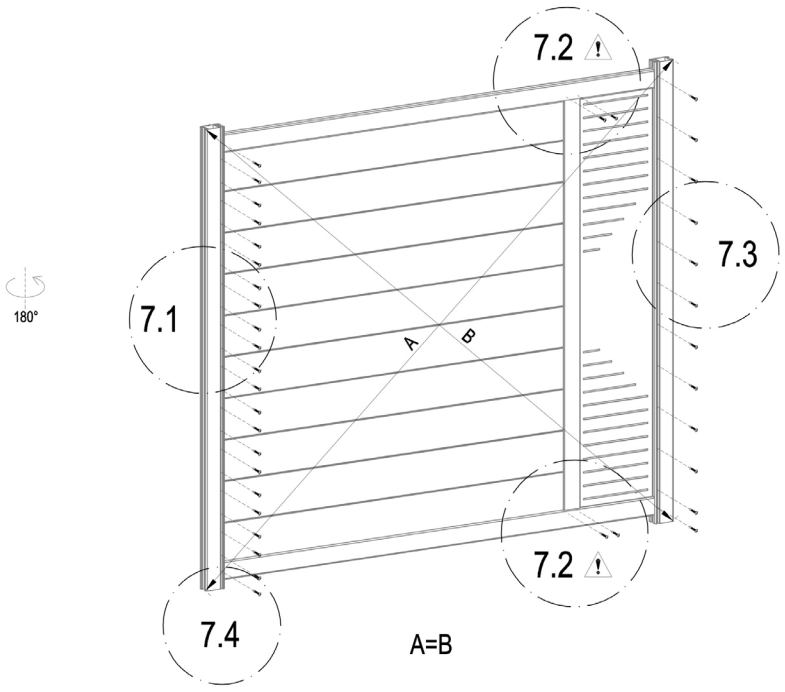



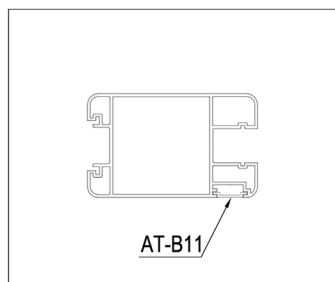
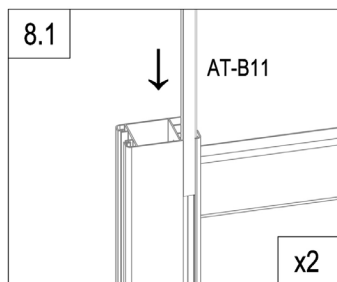
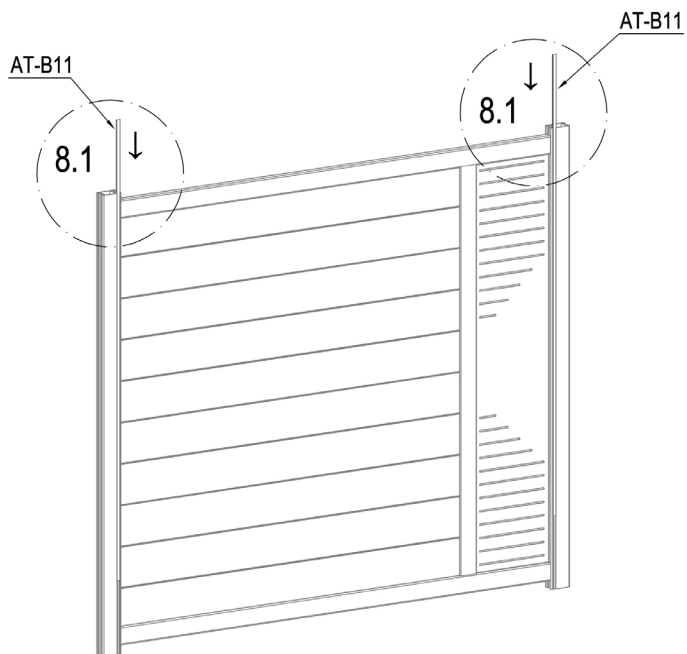

	AT-P34	34
	AT-P39	4

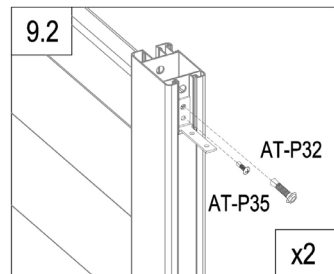
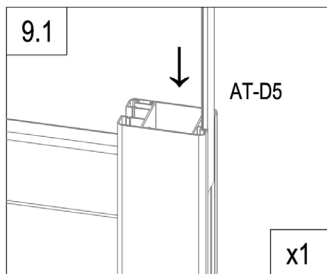
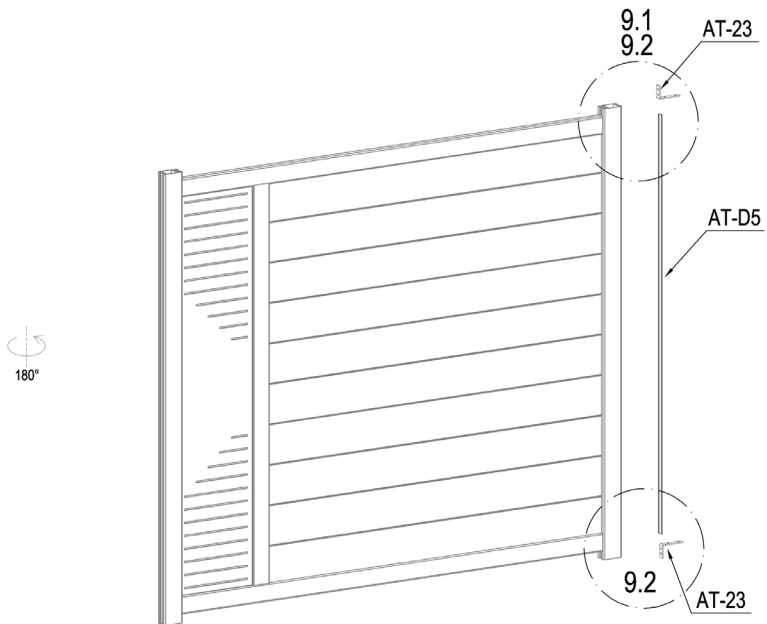





	AT-B11	2
-------------------------------------------------------------------------------------	--------	---

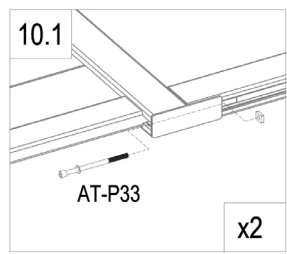
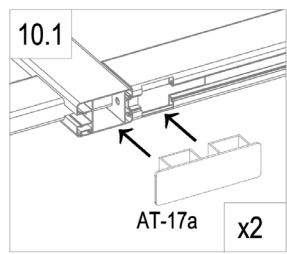
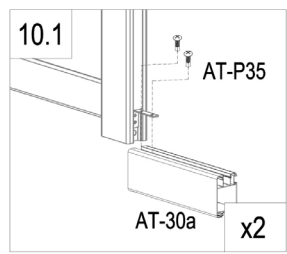
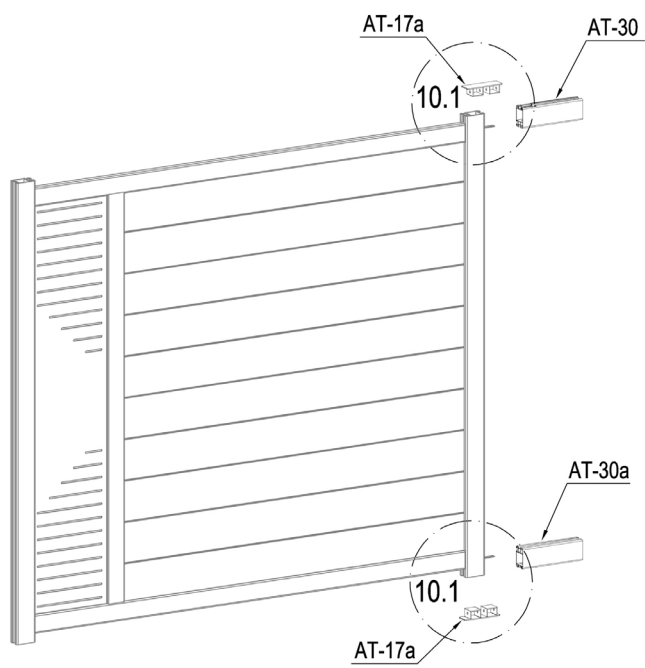





	AT-D5	1
	AT-23	2
	AT-P32	2
	AT-P35	2



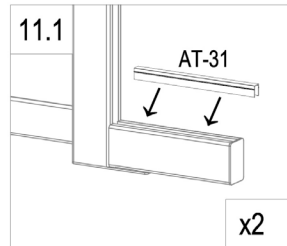
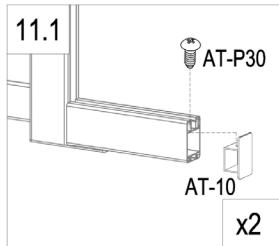
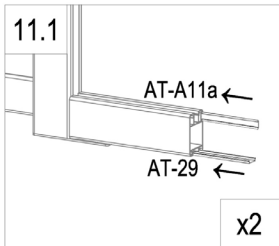
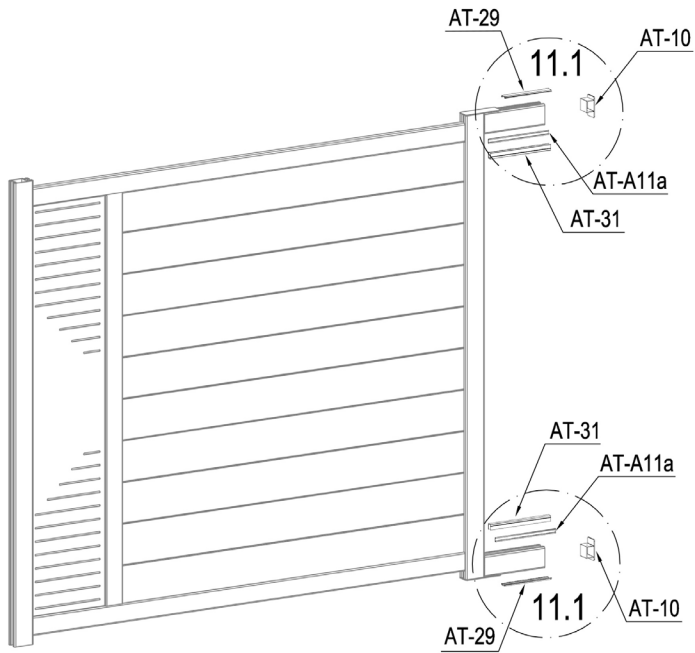

	AT-30	1
	AT-30a	1
	AT-17a	2

	AT-P33	2
	AT-P35	4



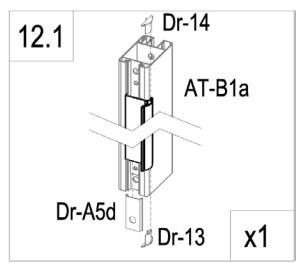
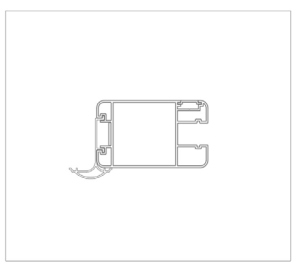
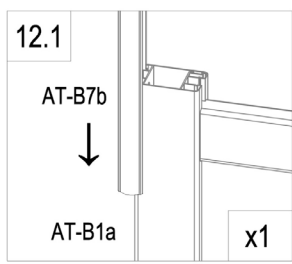
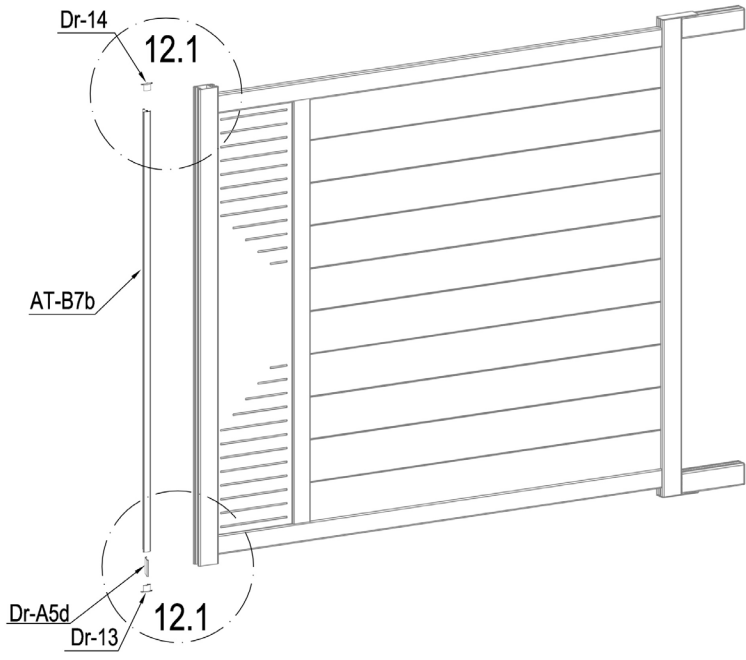

	AT-29	2
	AT-A11a	2
	AT-31	2

	AT-10	2
	AT-P30	2

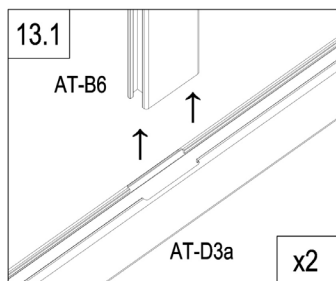
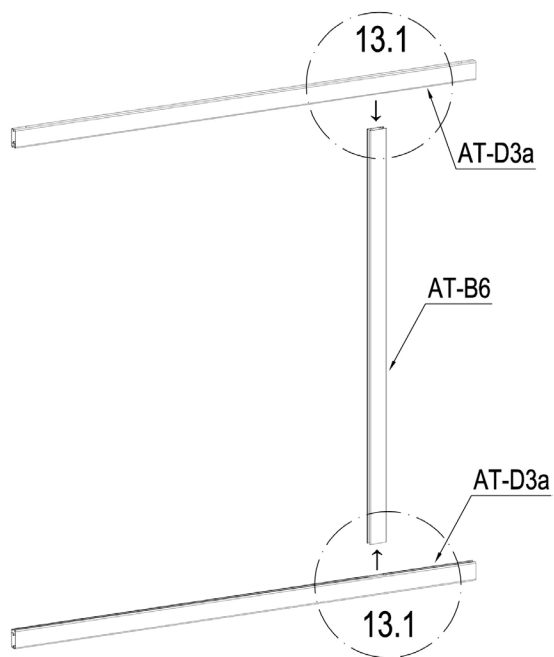

	AT-B7b	1
	Dr-A5d	1
	Dr-13	1
	Dr-14	1



	AT-B6	1
	AT-D3a	2

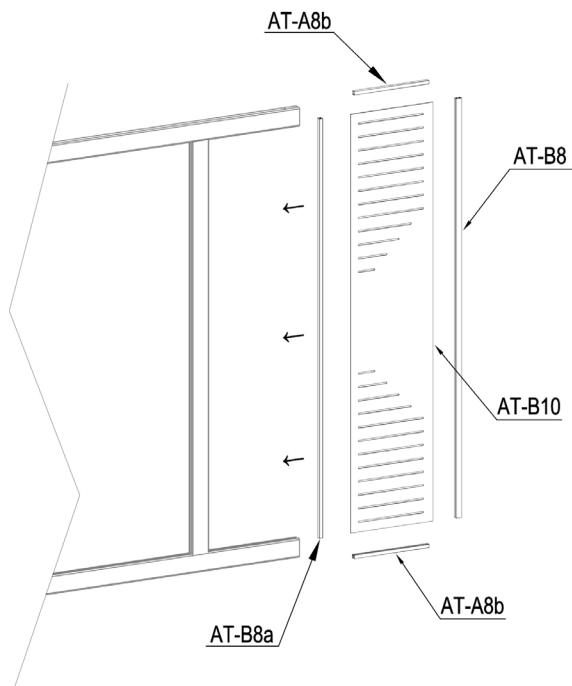



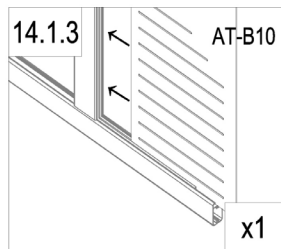
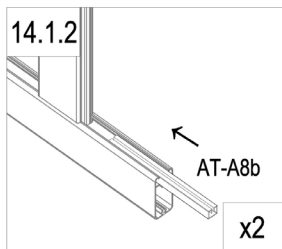
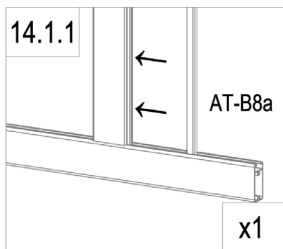

EN : you can flip and switch the direction of this plate to personalize your gate
 FR: vous pouvez retourner et changer la direction de cette plaque pour personnaliser votre portail
 DE: Sie können dieses Schild umdrehen und die Richtung wechseln, um Ihr Tor zu personalisieren.
 ES: puedes girar y cambiar la dirección de esta placa para personalizar tu puerta
 PT: pode virar e mudar a direção desta placa para personalizar o seu portão
 IT: potete capovolgere e cambiare la direzione di questa piastra per personalizzare il vostro cancello
 NL: u kunt de richting van deze plaat omdraaien en veranderen om uw poort te verpersoonlijken...
 PL: można obrócić i przelączyć kierunek tej płyty, aby spersonalizować bramę.

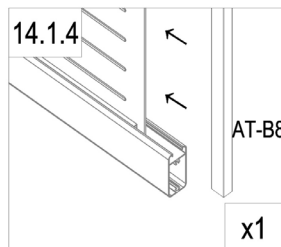

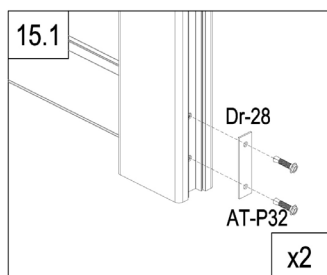
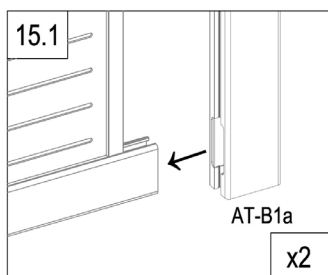
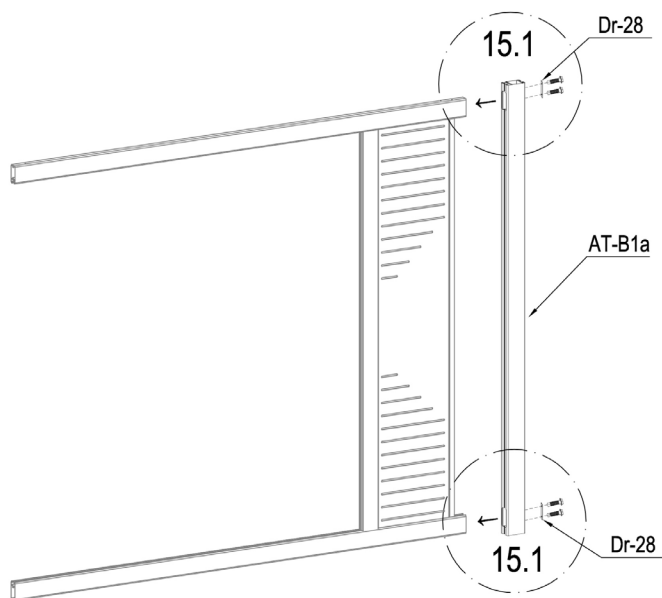
	AT-B8a	1
	AT-A8b	2
	AT-B10	1
	AT-B8	1





	AT-B1a	1
	Dr-28	2
	AT-P32	4

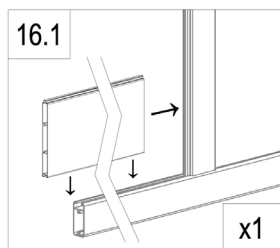
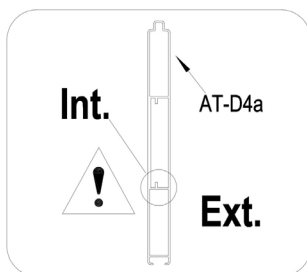
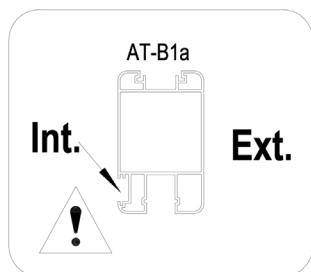
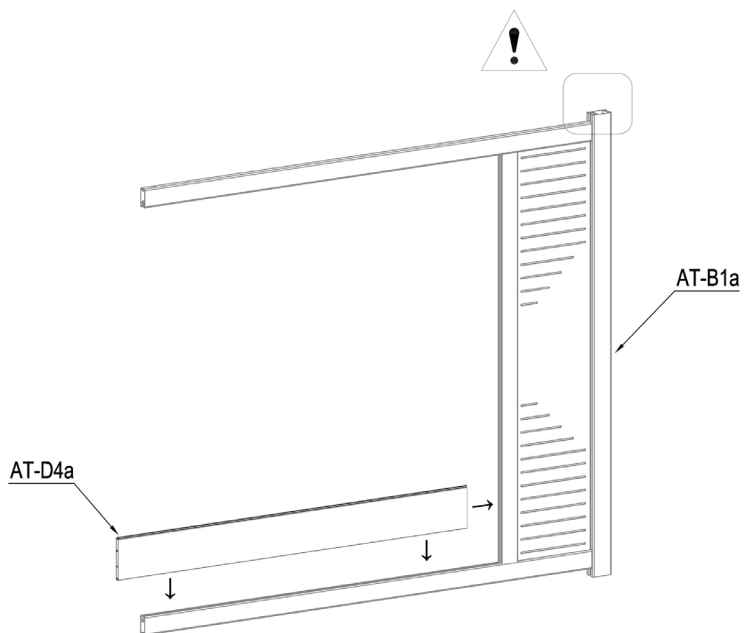

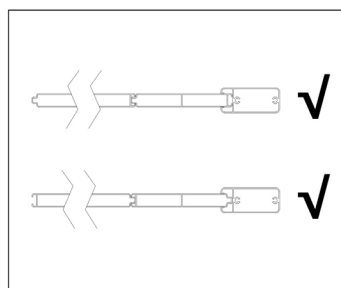
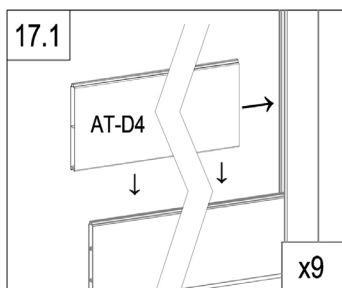
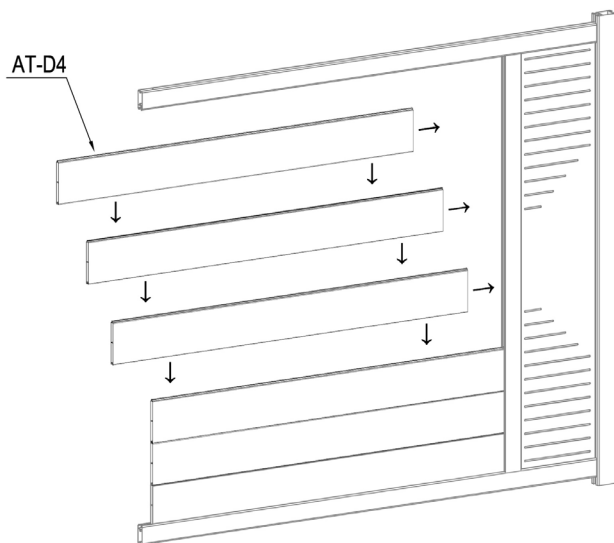

	AT-D4a	1
--	--------	---



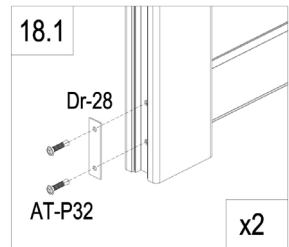
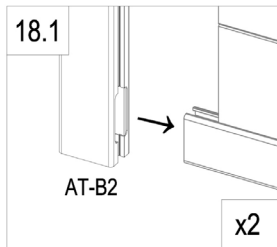
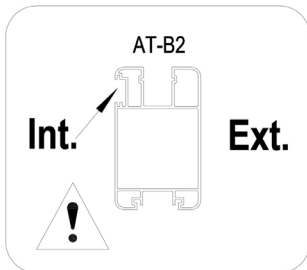
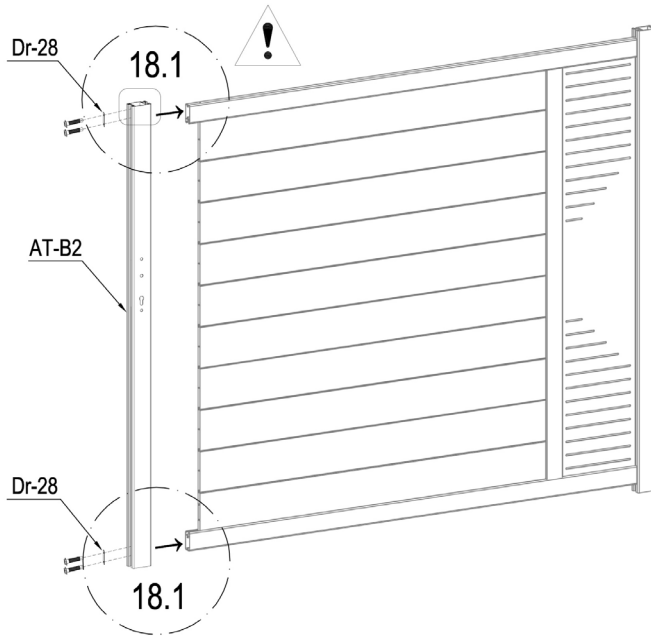

	AT-D4	9
-------------------------------------------------------------------------------------	-------	---

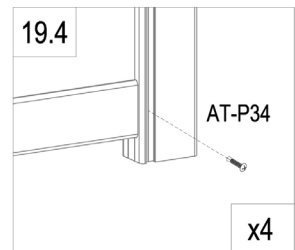
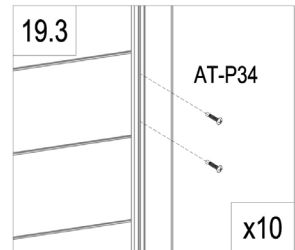
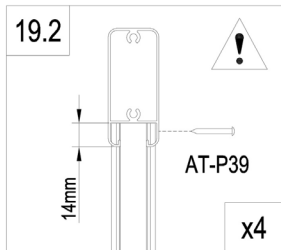
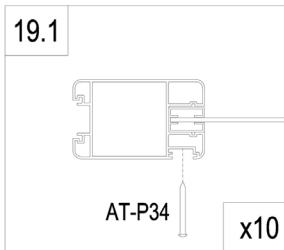
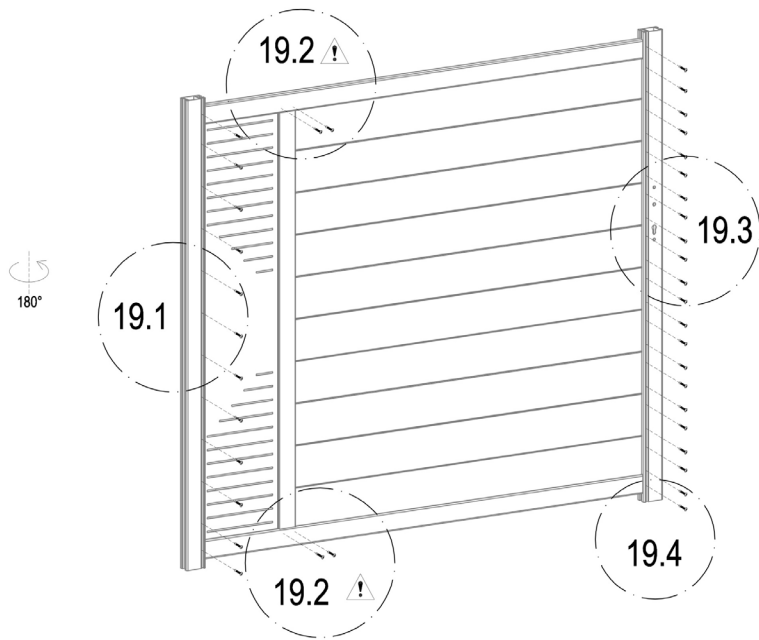

	AT-B2	1
	Dr-28	2
	AT-P32	4



	AT-P34	34
	AT-P39	4

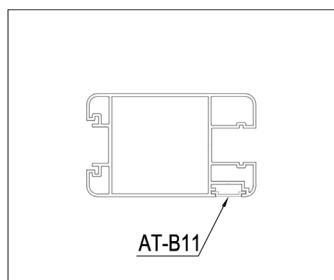
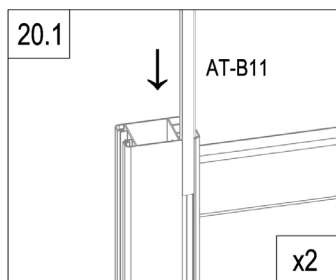
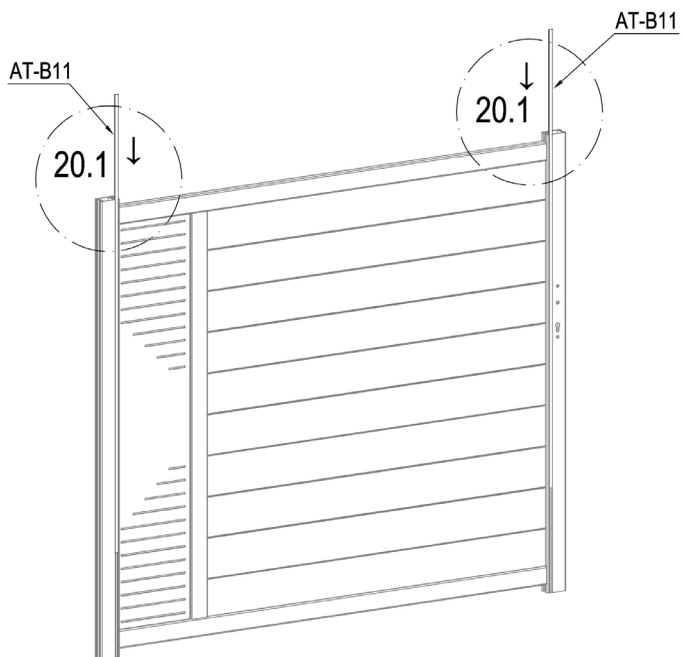

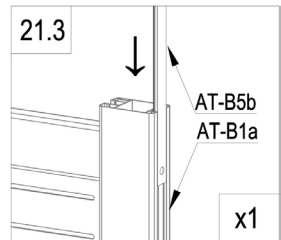
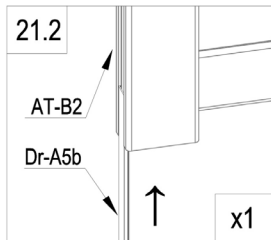
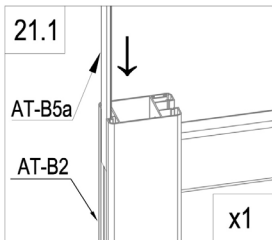
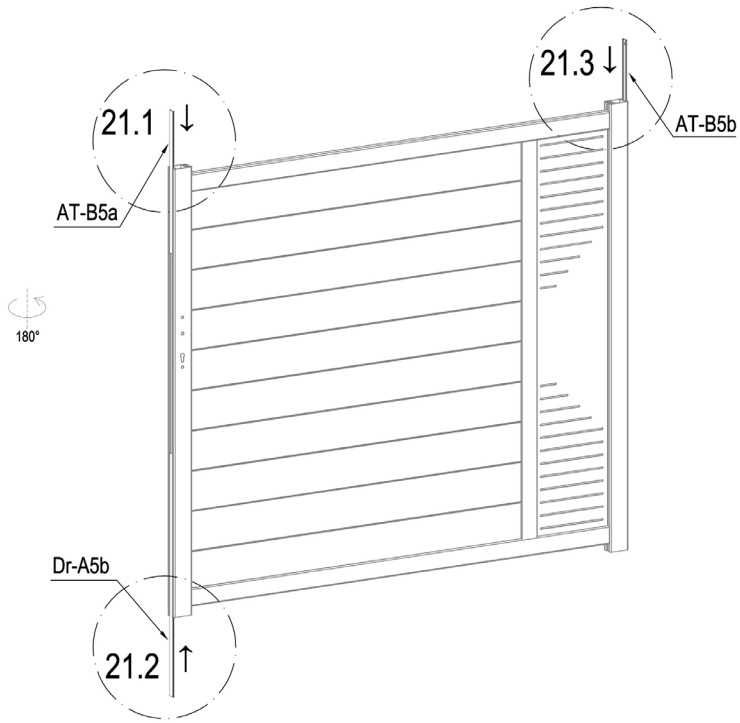

	AT-B11	2
-------------------------------------------------------------------------------------	--------	---



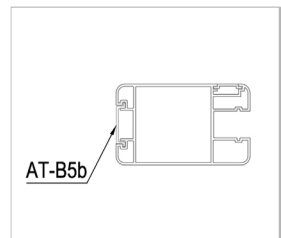

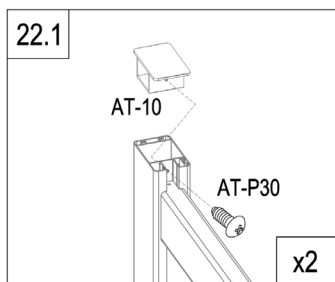
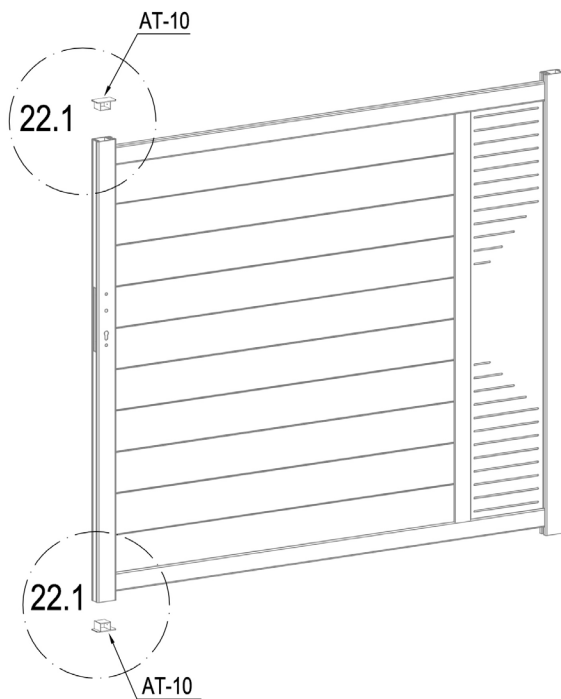
	AT-B5b	1
	AT-B5a	1
	Dr-A5b	1



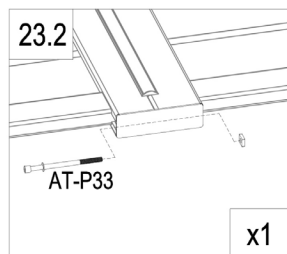
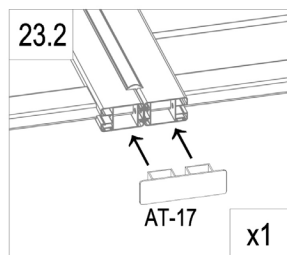
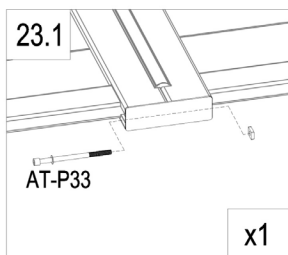
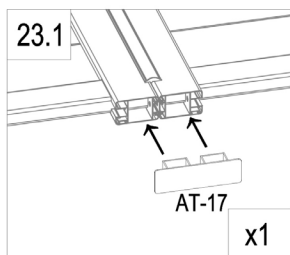
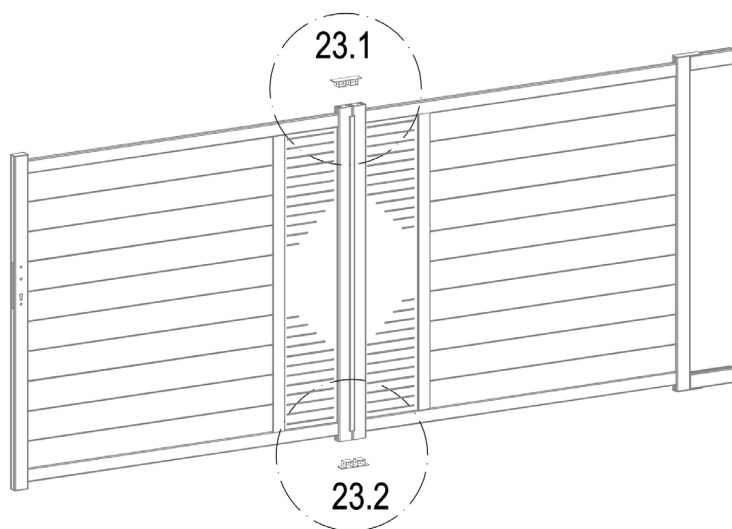

	AT-10	2
	AT-P30	2



	AT-17	2
	AT-P33	2

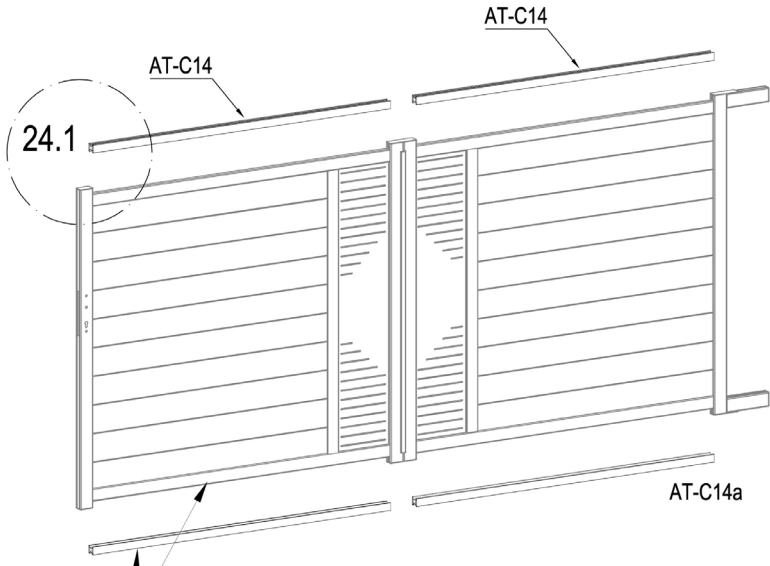



AT-C14a



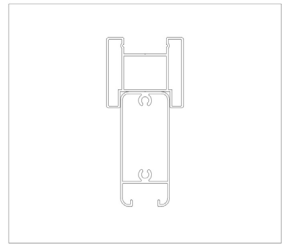
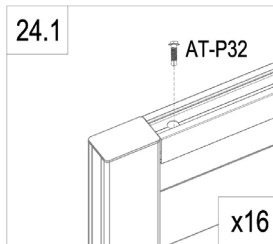
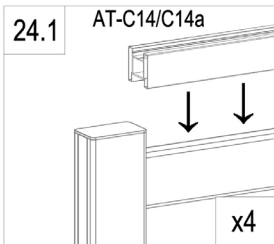

EN: These parts are made for connecting your gate's automation
 FR: Ces pièces sont faites pour relier l'automatisation de votre portail
 DE: Diese Teile sind für den Anschluss der Automatisierung Ihres Tores vorgesehen
 ES: Estas piezas están hechas para conectar la automatización de su puerta
 PT: Estas peças são feitas para ligar a automatização do seu portão
 IT: Queste parti sono realizzate per collegare l'automazione del vostro cancello
 NL: Deze onderdelen zijn gemaakt voor het aansluiten van de automatisering van uw poort.
 PL: Te części są wykonane do podłączenia automatyki bramy.

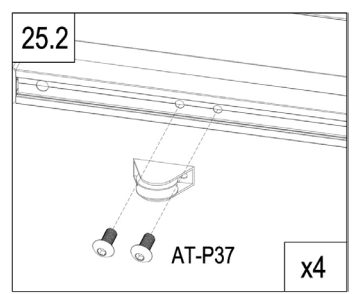
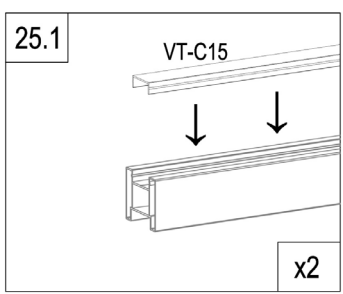
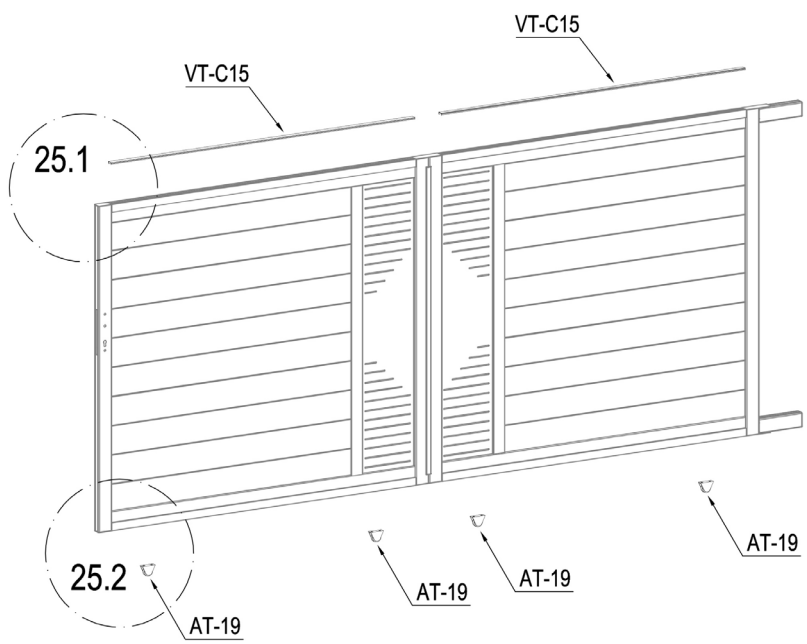

	AT-C14	2
	AT-C14a	2
	AT-P32	16



	VT-C15	2
	AT-19	4
	AT-P37	8

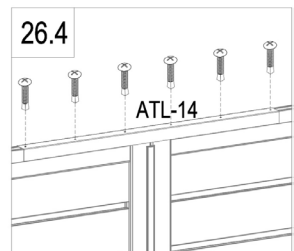
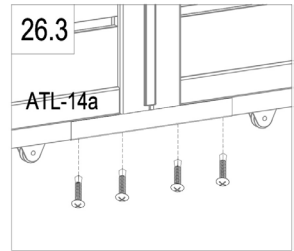
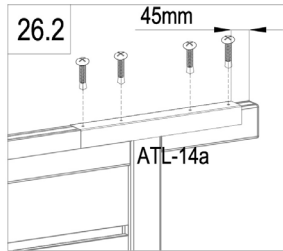
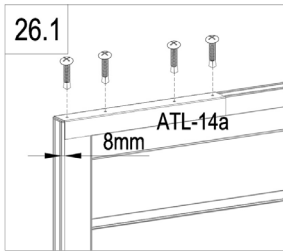
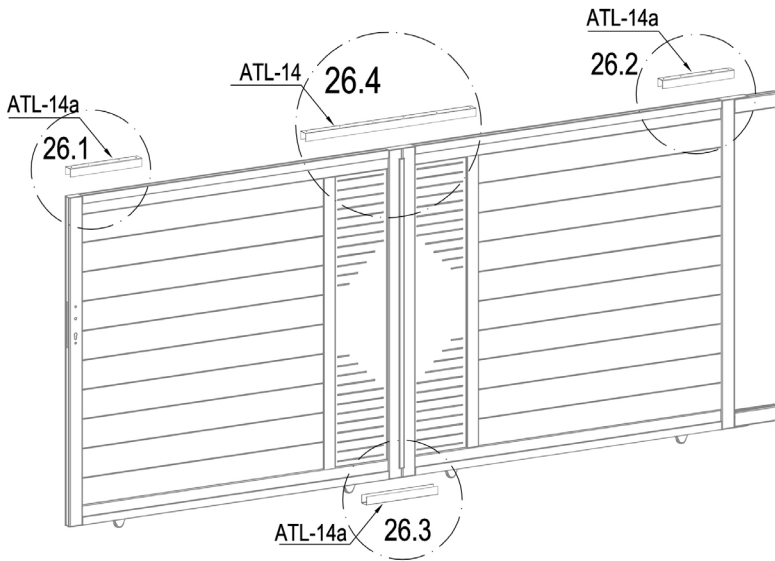

	ATL-14	1
	ATL-14a	3
	AT-P34	18

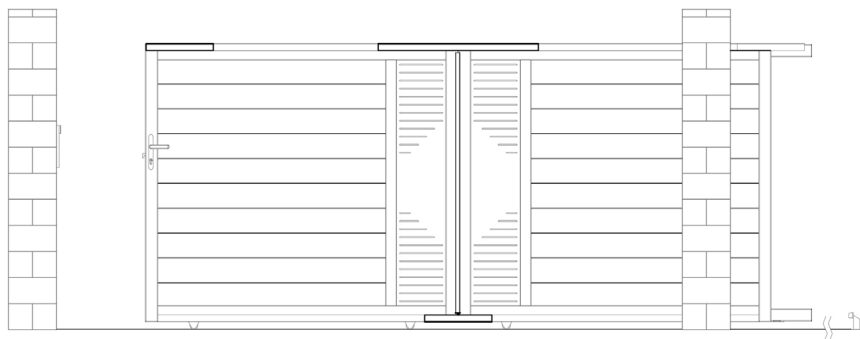

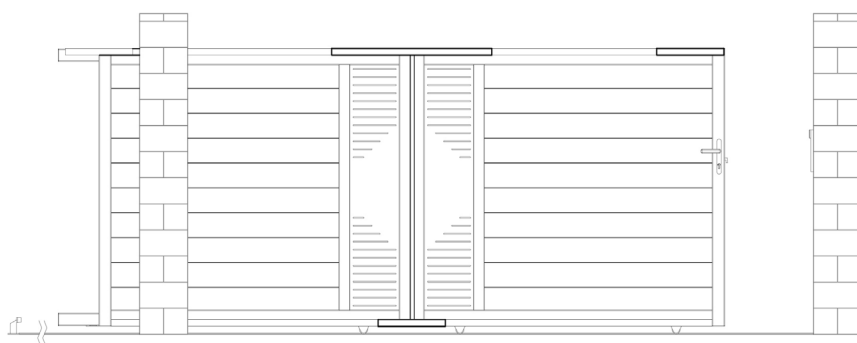

L : P27~32

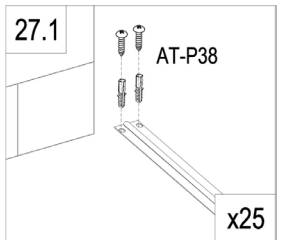
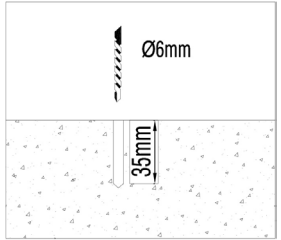
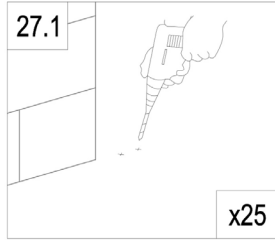
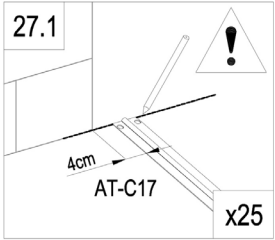
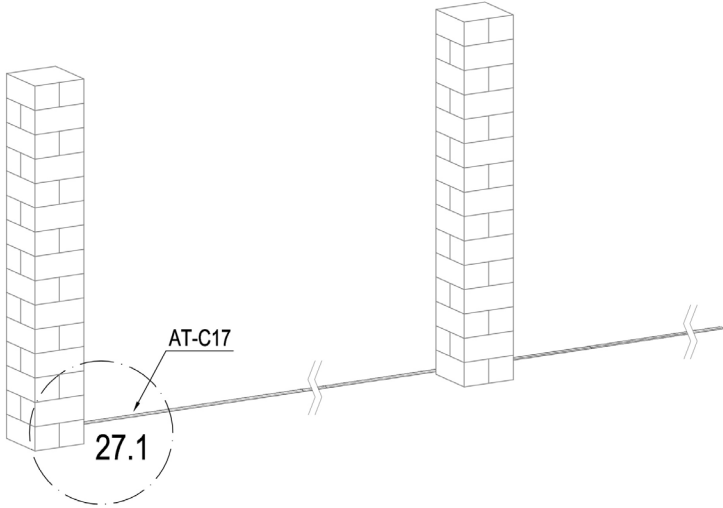

R : P33~38

L



	AT-C17	5
	AT-P38	50

L

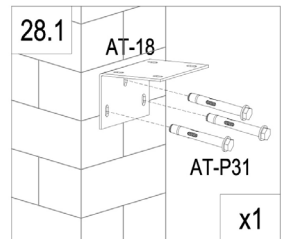
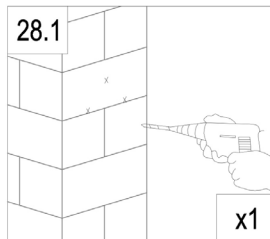
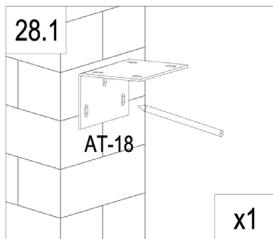
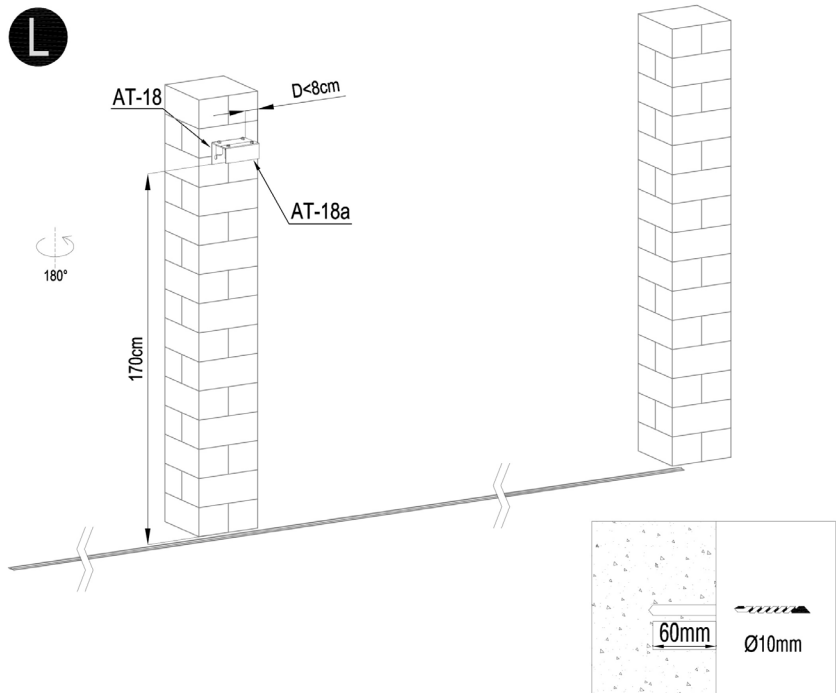

	AT-18	1
	AT-18a	1
	AT-20	4
	AT-P31	3

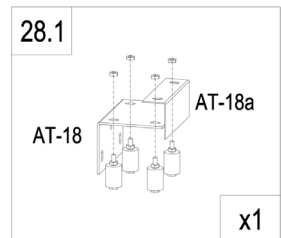
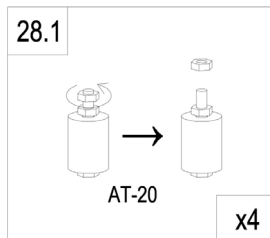

L

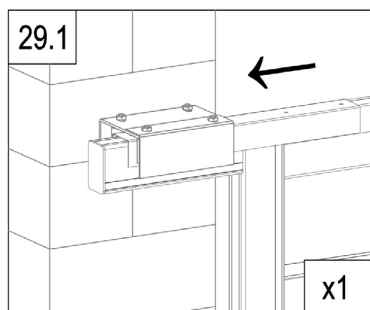
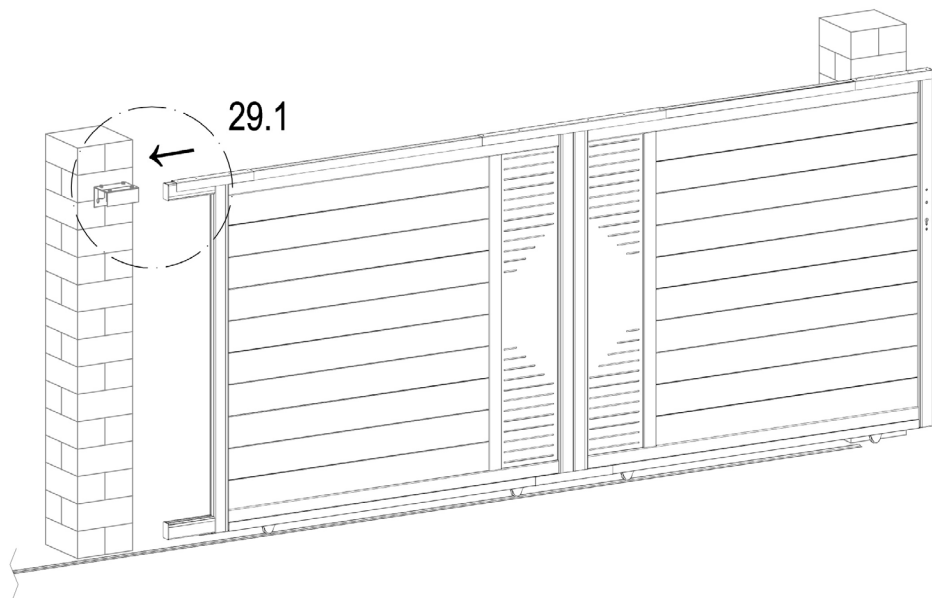

L

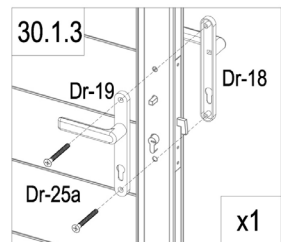
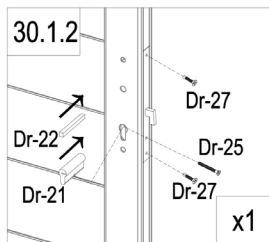
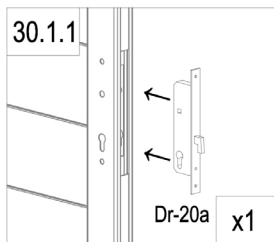
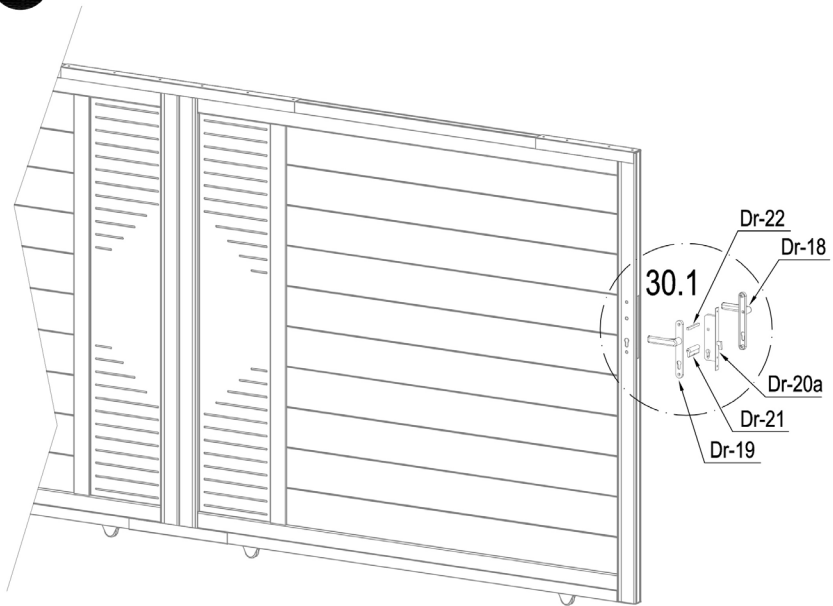



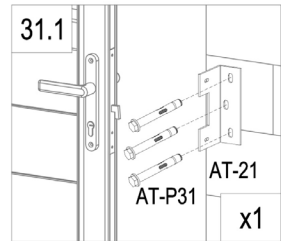
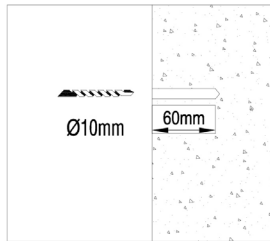
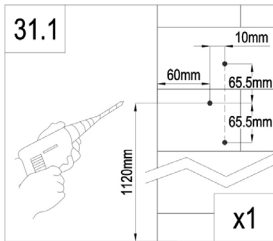
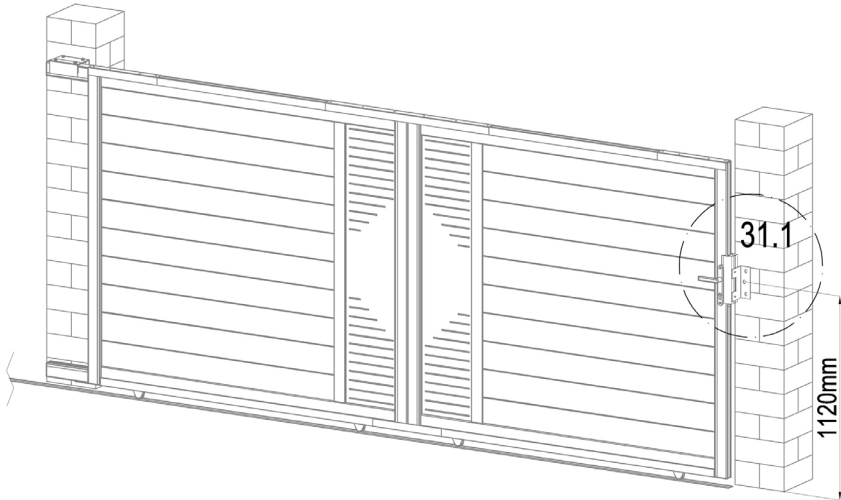

	Dr-20a	1
	Dr-21	1
	Dr-22	1
	Dr-25	1

	Dr-18	1
	Dr-19	1
	Dr-25a	2
	Dr-27	2

L



	AT-16	1
	AT-21	1
	AT-P36	2
	AT-P31	3
	AT-22J	3

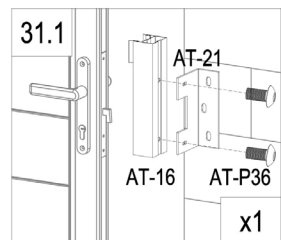
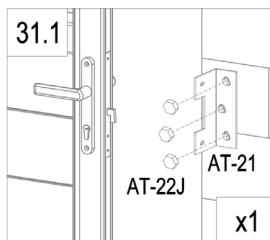

L

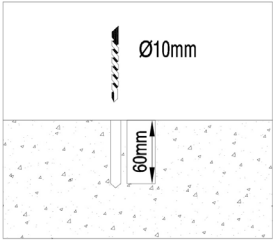
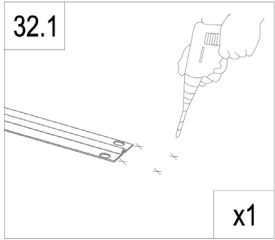
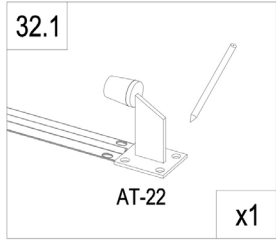
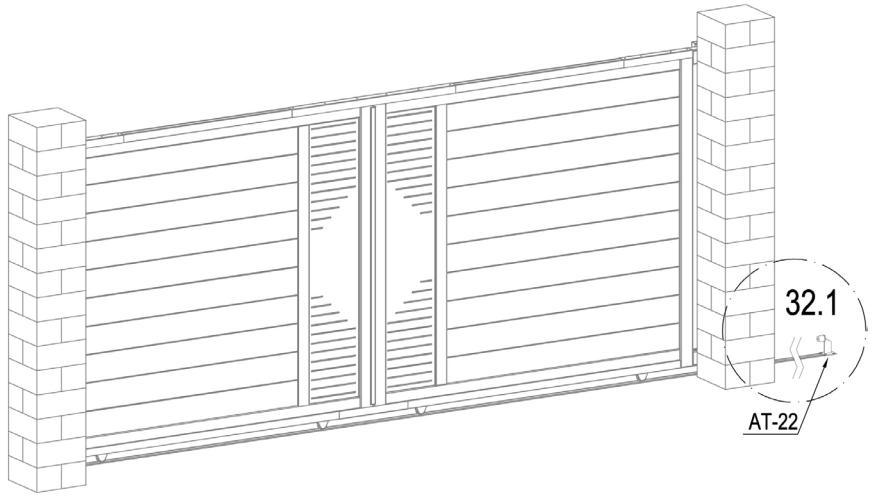

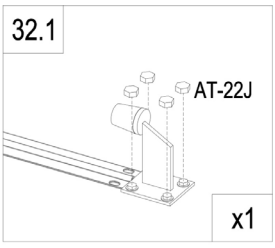
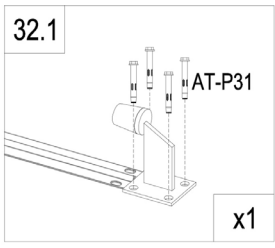

	AT-22	1
	AT-P31	4
	AT-22J	4

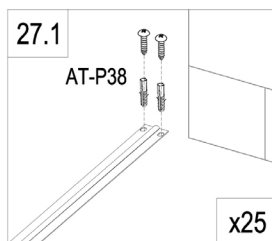
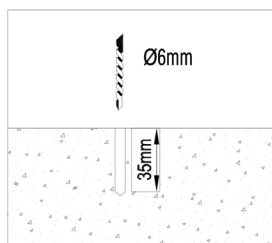
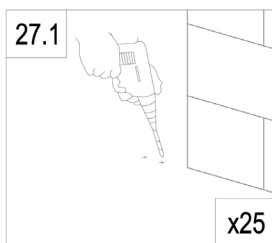
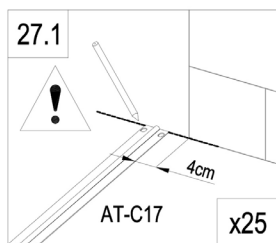
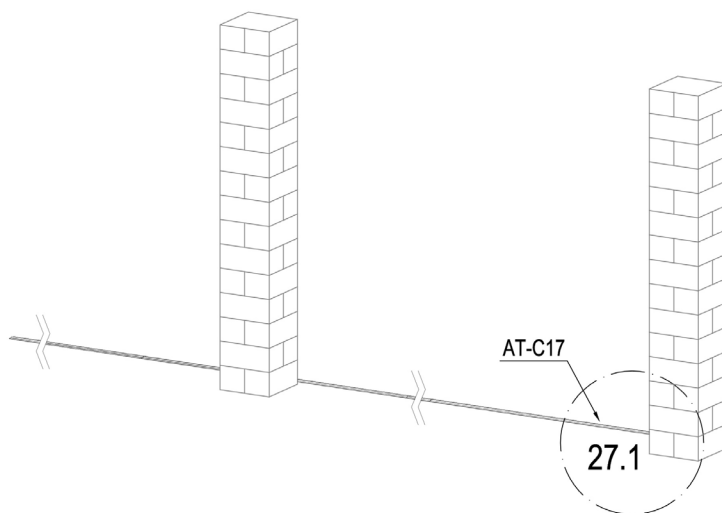

R



	AT-C17	5
	AT-P38	50

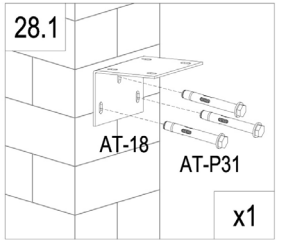
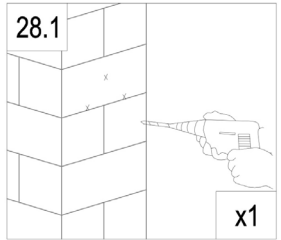
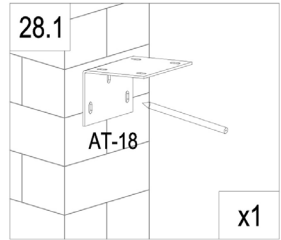
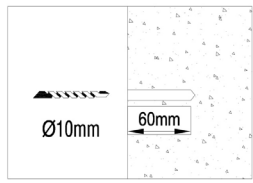
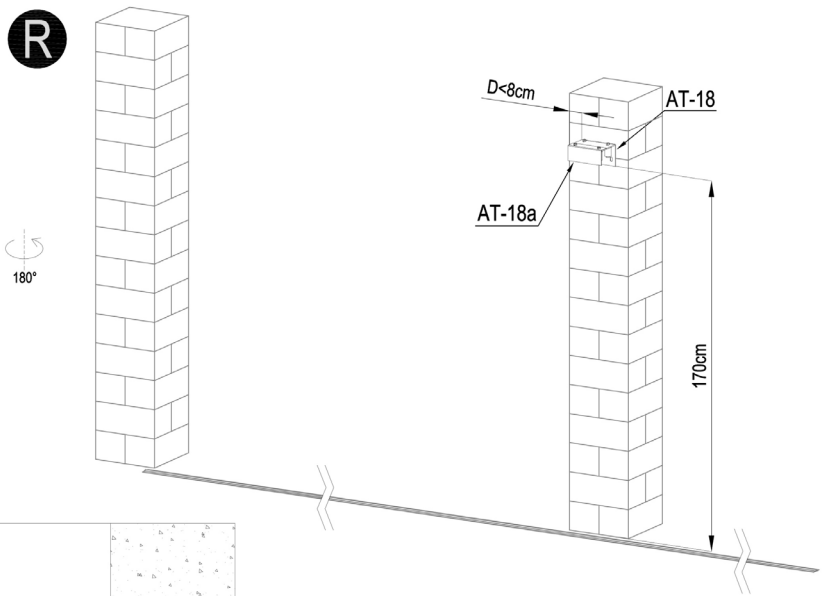

	AT-18	1
	AT-18a	1
	AT-20	4
	AT-P31	3

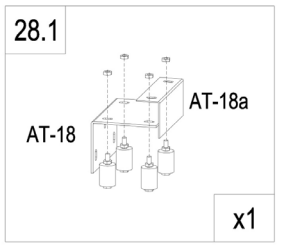
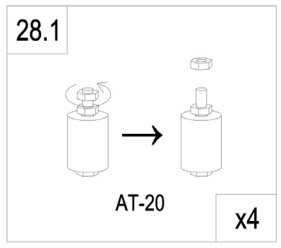

R

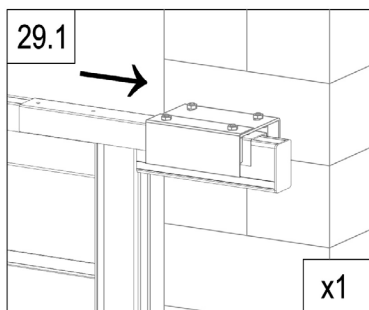
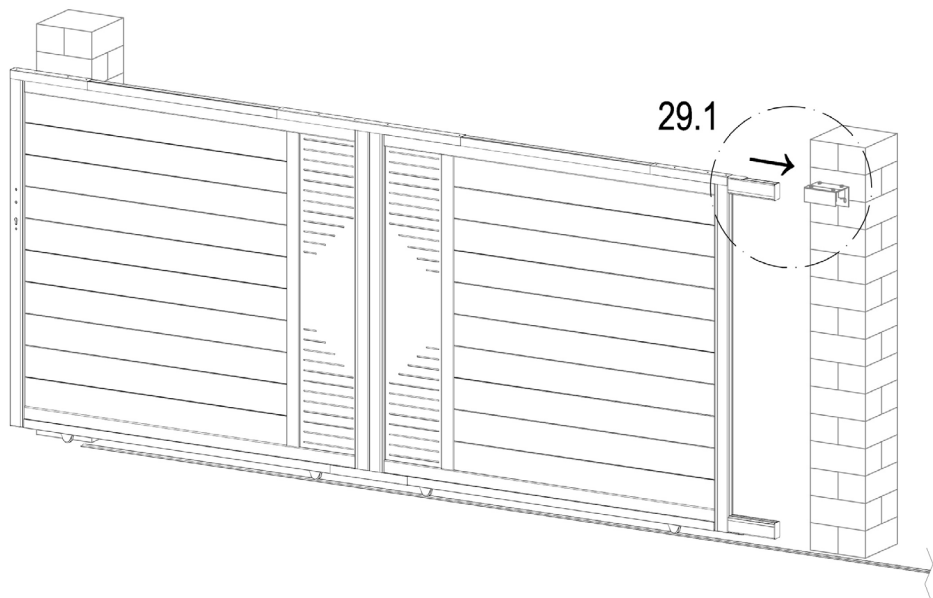

R

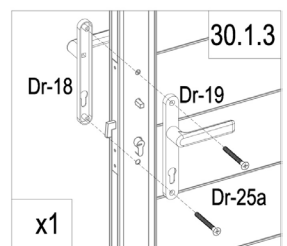
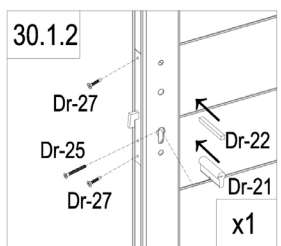
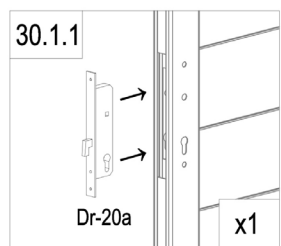
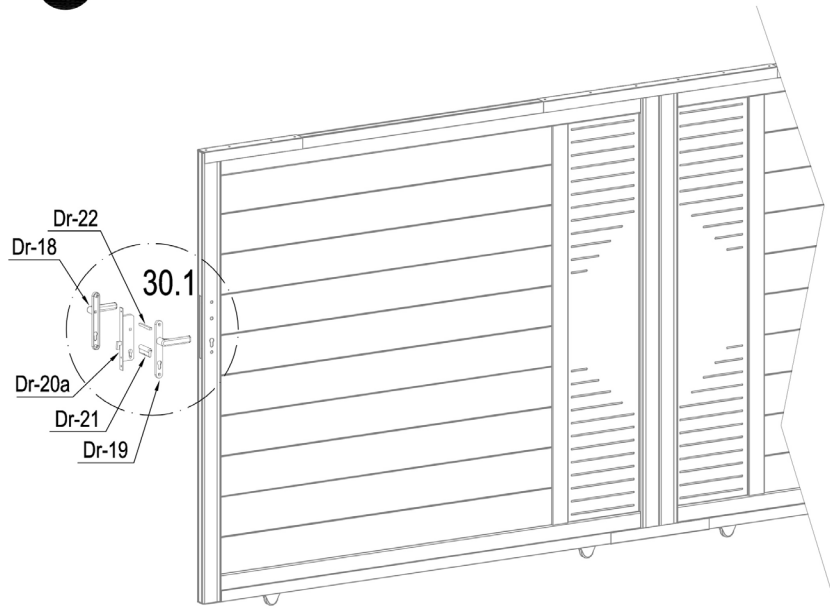

	Dr-20a	1
	Dr-21	1
	Dr-22	1
	Dr-25	1

	Dr-18	1
	Dr-19	1
	Dr-25a	2
	Dr-27	2

R

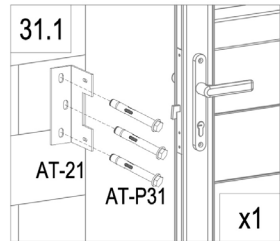
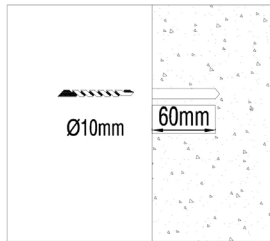
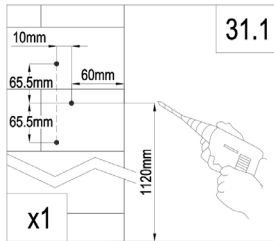
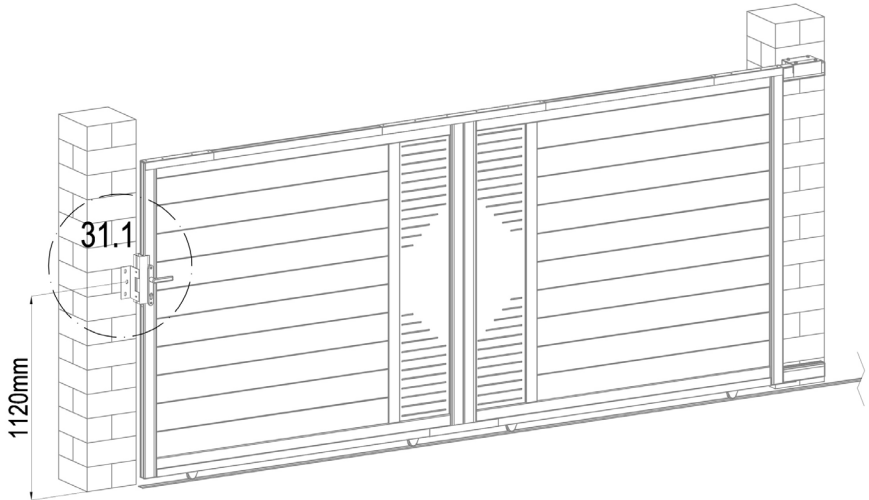

	AT-16	1
	AT-21	1
	AT-P36	2
	AT-P31	3
	AT-22J	3

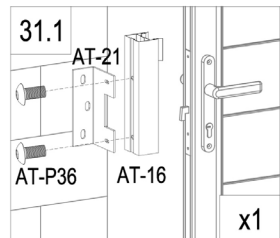
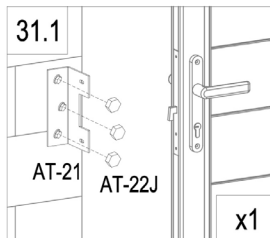

R

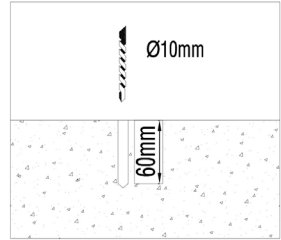
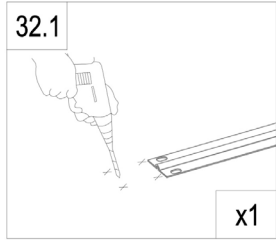
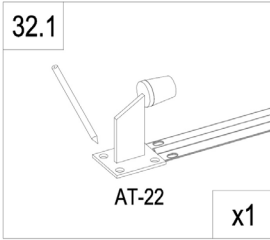
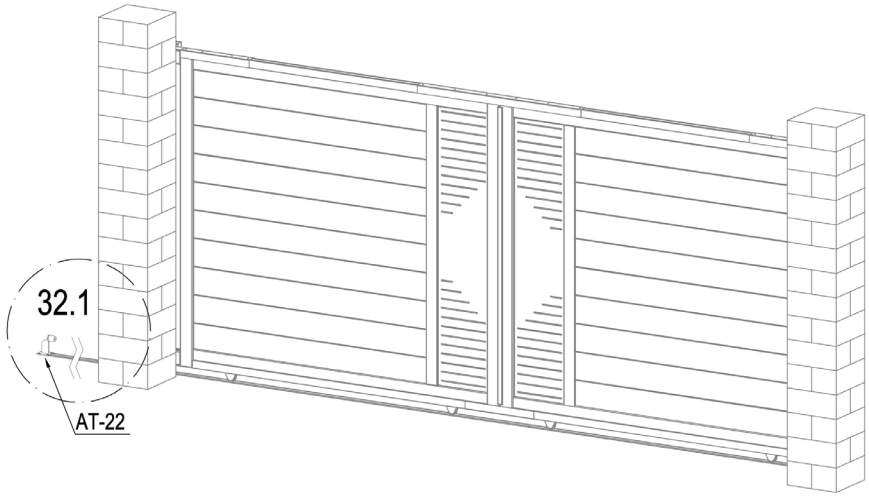

	AT-22	1
	AT-P31	4
	AT-22J	4

