

CASANOVO

SUNNY 400C160

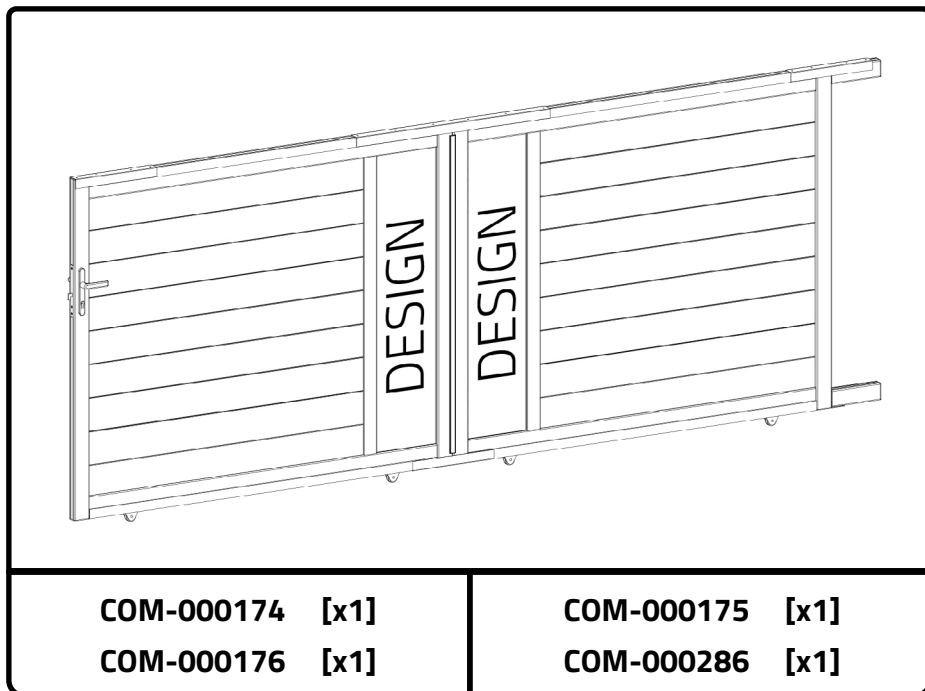

INSTRUCTION MANUAL / NOTICE DE MONTAGE / MONTAGEANLEITUNG / MANUAL DE MONTAJE / MANUAL DE MONTAGEM / MANUALE DI MONTAGGIO /
MONTAGEHANDLEIDING / INSTRUKCJA MONTAŻU / KÄYTTÖOHJEET / BRUKSANVISNING / BRUGSANVISNING / INSTRUCIUNI DE ASAMBLARE /
NAVODILA ZA SESTAVLJANJE / NÁVOD NA MONTÁŽ / ÖSSZESZERELÉSI ÚTMUTATÓ / NÁVOD K MONTÁŽI / UPUTE ZA INSTALACIJU /
ΟΔΗΓΙΕΣ ΣΥΝΑΡΜΟΛΟΓΗΣΗΣ / SURINKIMO INSTRUKCIJOS / MONTĀŽAS INSTRUKCIJAS

Ext.

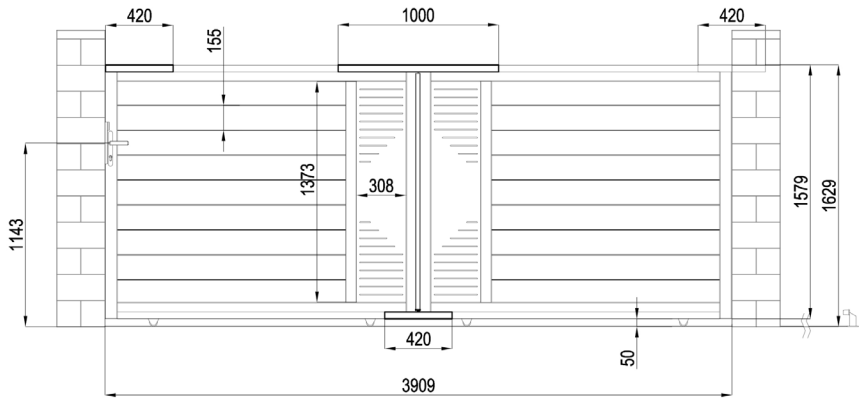

Int.

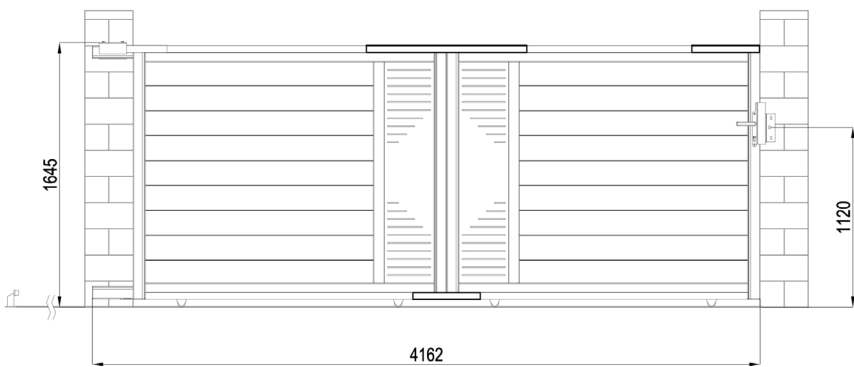

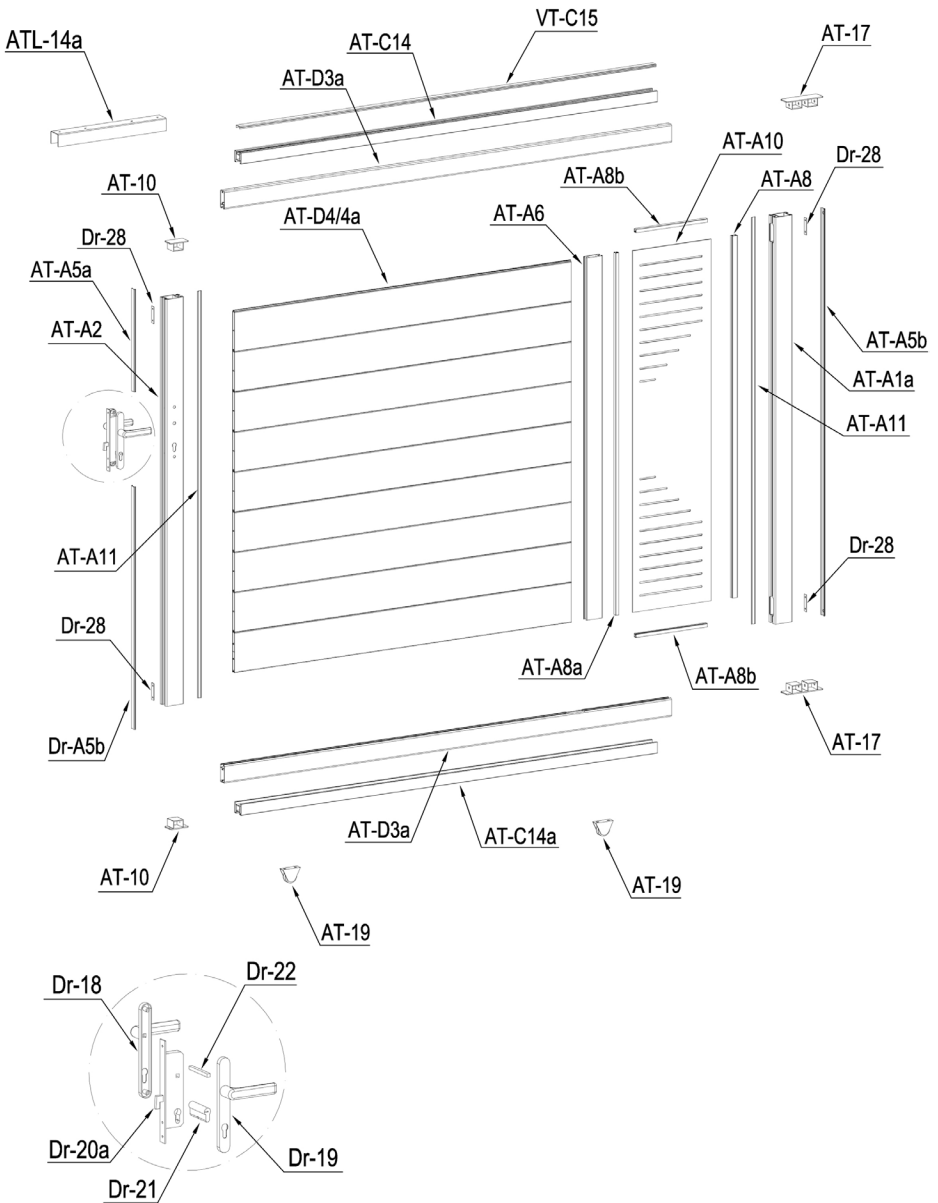



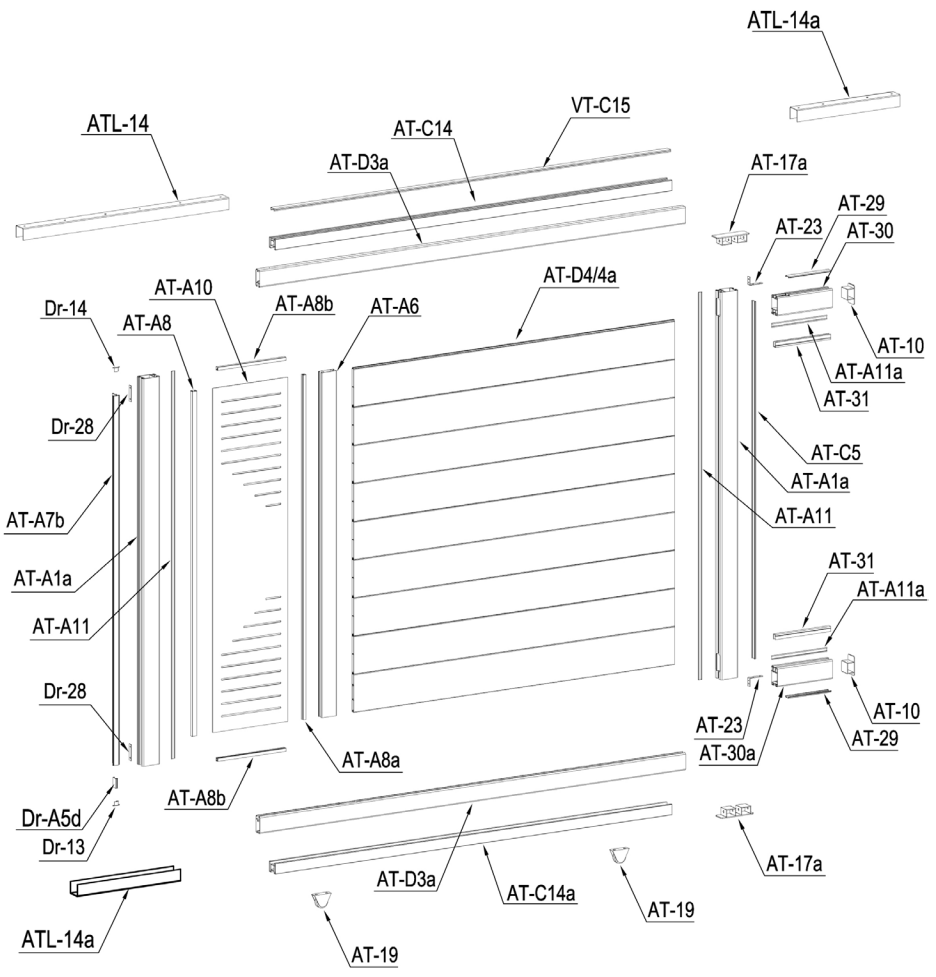

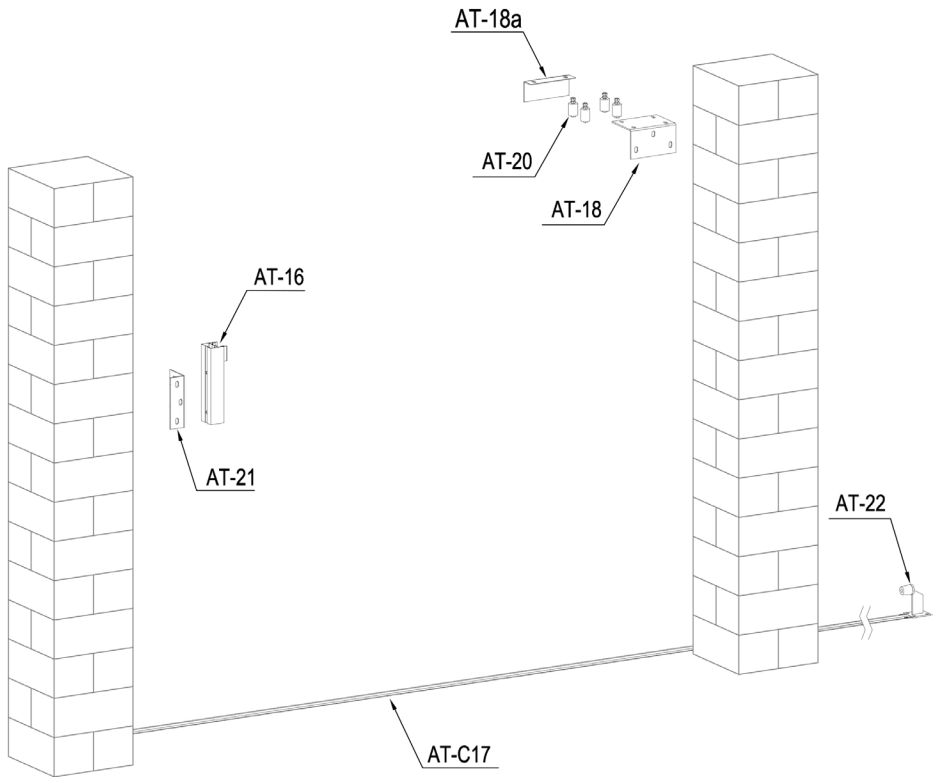













































CASANOVO





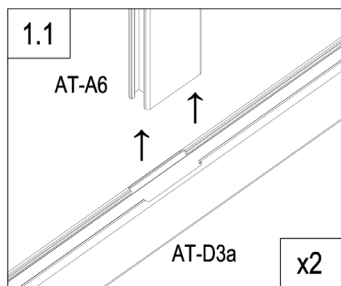
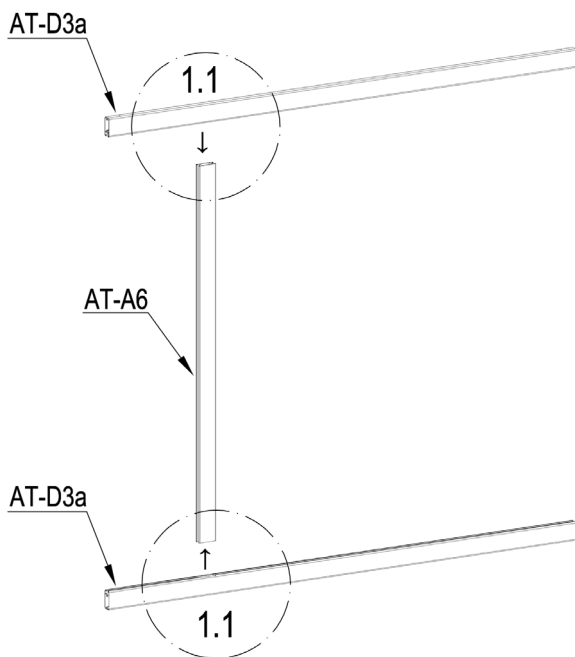

PART LIST

| IMAGE | NO. | L.(mm) | QTY | IMAGE | NO. | L.(mm) | QTY |
|---|---------|--------|-----|---|--------|--------|-----|
|  | AT-A1a | 1573 | 3 |  | AT-10 | | 4 |
| | AT-A2 | 1573 | 1 |  | Dr-13 | | 1 |
| | AT-30 | 250 | 1 |  | Dr-14 | | 1 |
| | AT-30a | 250 | 1 |  | AT-18 | | 1 |
|  | AT-D3a | 1931 | 4 |  | AT-18a | | 1 |
|  | AT-D4 | 1455 | 16 |  | AT-19 | | 4 |
|  | AT-D4a | 1455 | 2 |  | AT-20 | | 4 |
|  | AT-A5b | 1573 | 1 |  | AT-21 | | 1 |
| | AT-C5 | 1448 | 1 |  | AT-22 | | 1 |
| | AT-A5a | 395.5 | 1 |  | AT-23 | | 2 |
| | Dr-A5b | 937 | 1 |  | Dr-18 | | 1 |
| | AT-29 | 193 | 2 |  | Dr-19 | | 1 |
| | Dr-A5d | 52 | 1 |  | Dr-20a | | 1 |
|  | AT-A10 | 1398 | 2 |  | Dr-21 | | 1 |
|  | AT-A6 | 1401 | 2 |  | Dr-22 | | 1 |
|  | AT-A8 | 1400 | 2 |  | Dr-25 | | 1 |
|  | AT-B8a | 1400 | 2 |  | Dr-25a | | 2 |
| | AT-A8b | 308.5 | 4 |  | Dr-27 | | 2 |
|  | AT-A11 | 1573 | 4 |  | Dr-28 | | 6 |
| | AT-A11a | 250 | 2 |  | AT-22J | | 7 |
|  | AT-31 | 250 | 2 |  | AT-L30 | | 4 |
|  | AT-A7b | 1468 | 1 |  | AT-L31 | | 10 |
|  | AT-C14 | 1798 | 2 |  | AT-L32 | | 32 |
| | AT-C14a | 1798 | 2 |  | AT-L33 | | 4 |
|  | VT-C15 | 1797 | 2 |  | AT-L34 | | 81 |
|  | AT-16 | 260 | 1 |  | AT-L35 | | 6 |
|  | AT-C17 | 1580 | 5 |  | AT-L36 | | 2 |
|  | ATL-14 | 1000 | 1 |  | AT-L37 | | 8 |
|  | ATL-14a | 420 | 3 |  | AT-L38 | | 50 |
|  | AT-17 | | 2 |  | AT-L39 | | 8 |
|  | AT-17a | | 2 | | | | |



| | | |
|---|--------|---|
|  | AT-A6 | 1 |
|  | AT-D3a | 2 |

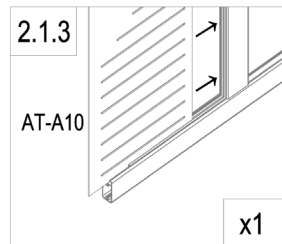
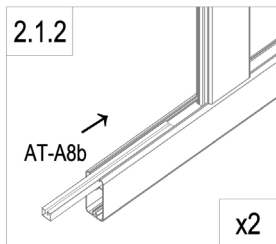
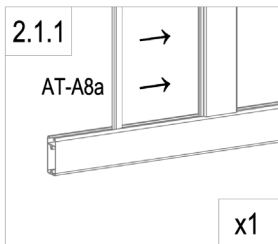
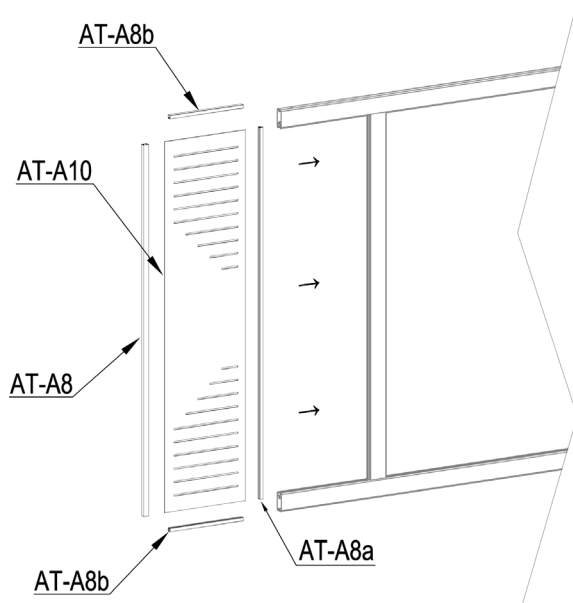

EN :you can flip and switch the direction of this plate to personalize your gate
 FR: vous pouvez retourner et changer la direction de cette plaque pour personnaliser votre portail
 DE: Sie können dieses Schild umdrehen und die Richtung wechseln, um Ihr Tor zu personalisieren.
 ES: puedes girar y cambiar la dirección de esta placa para personalizar tu puerta
 PT: pode virar e mudar a direção desta placa para personalizar o seu portão
 IT: potete capovolgere e cambiare la direzione di questa piastra per personalizzare il vostro cancello
 NL: u kunt de richting van deze plaat omdraaien en veranderen om uw poort te verpersoonlijken...
 PL: można obrócić i przeloczyć kierunek tej plyty, aby spersonalizowac brame.



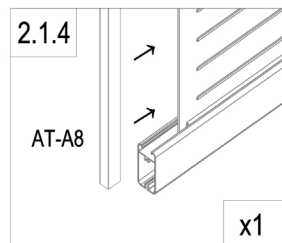

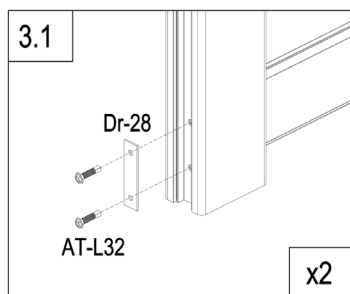
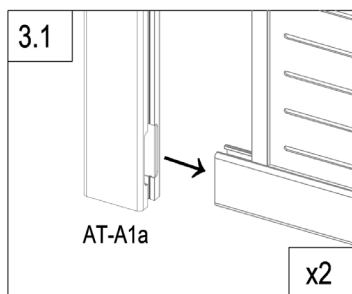
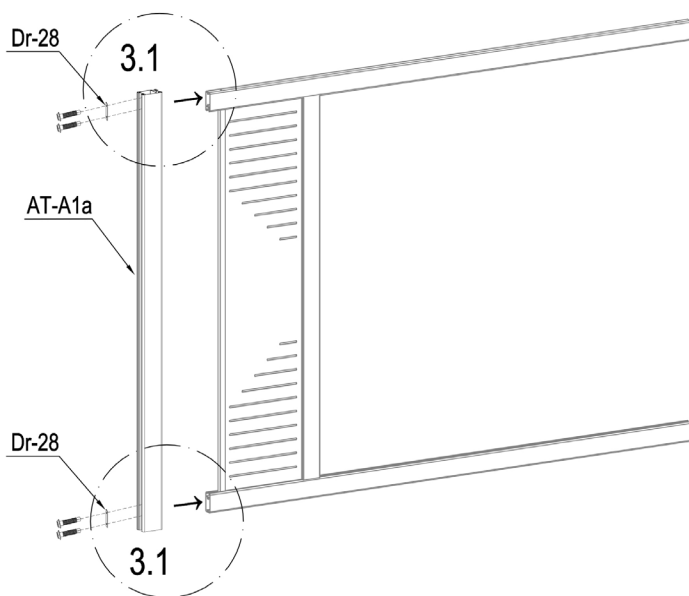
| | | |
|--|--------|---|
| | AT-A8a | 1 |
| | AT-A8b | 2 |
| | AT-A10 | 1 |
| | AT-A8 | 1 |





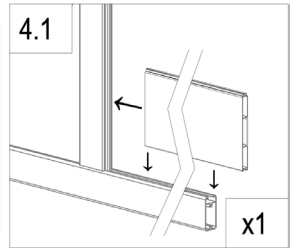
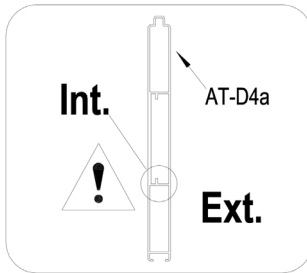
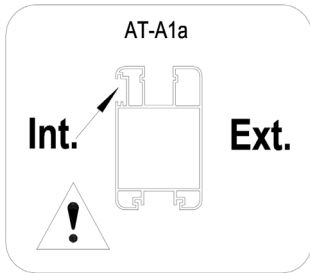
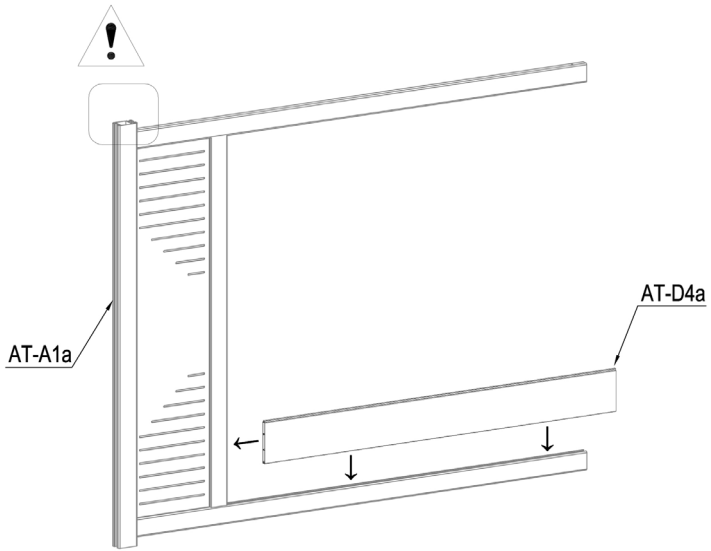

| | | |
|---|--------|---|
|  | AT-A1a | 1 |
|  | Dr-28 | 2 |
|  | AT-L32 | 4 |



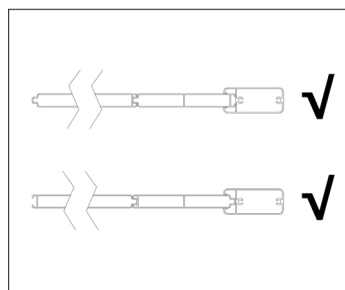
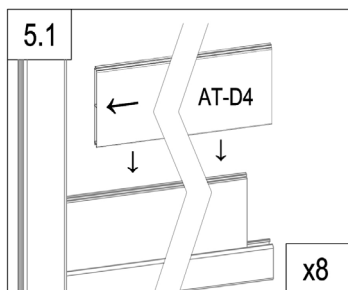
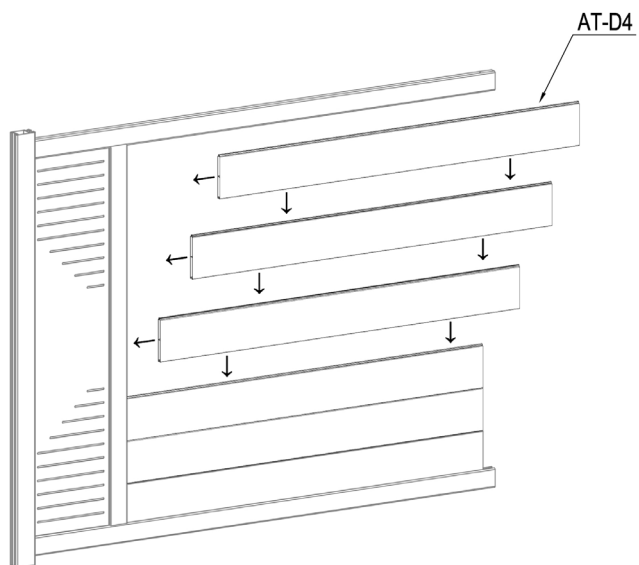

| | | |
|---|--------|---|
|  | AT-D4a | 1 |
|---|--------|---|



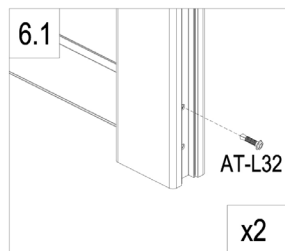
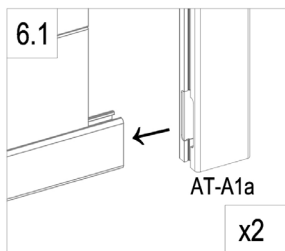
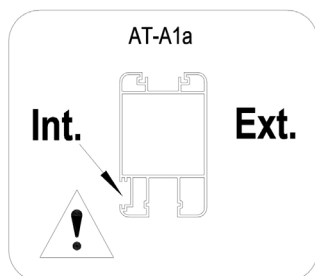
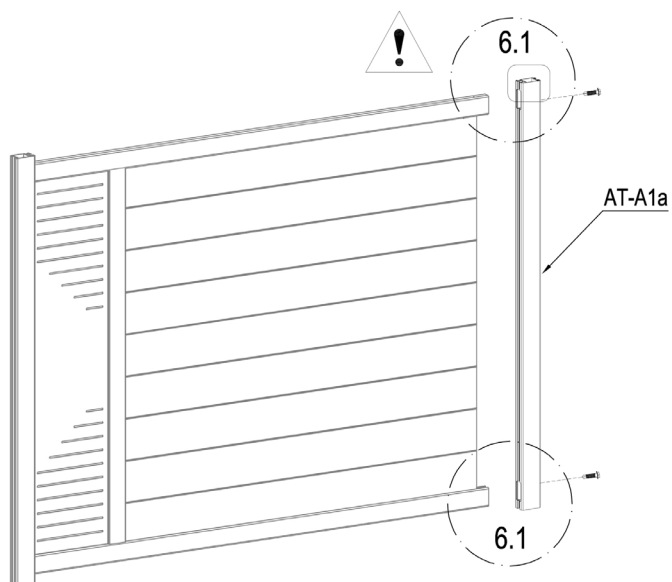

| | | |
|---|-------|---|
|  | AT-D4 | 8 |
|---|-------|---|

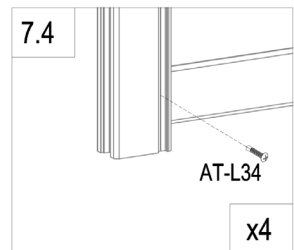
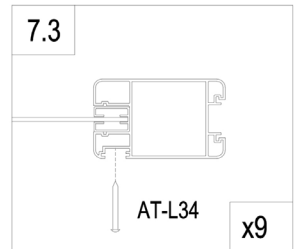
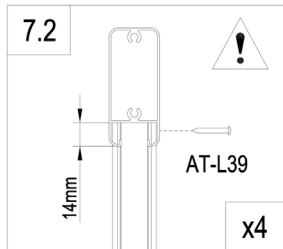
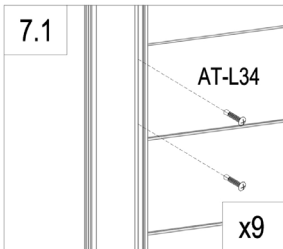
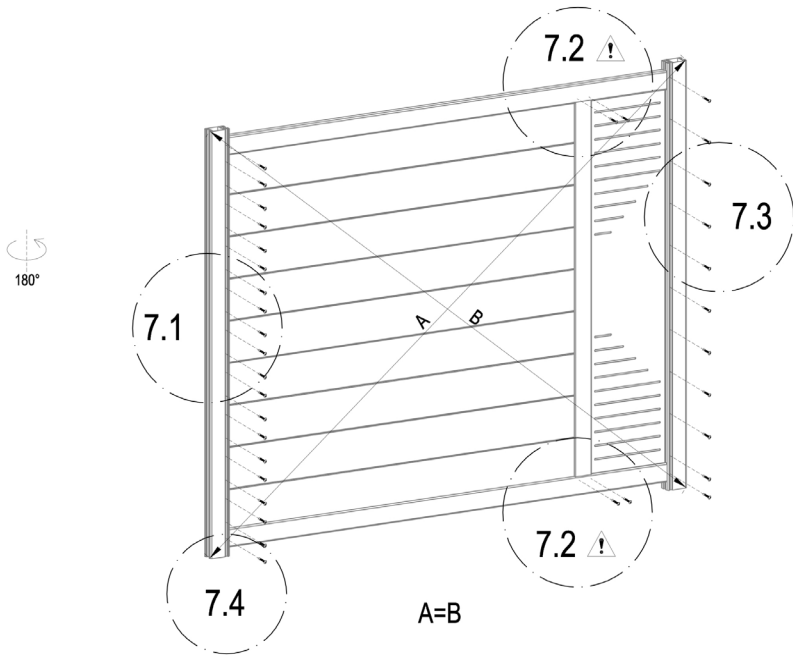

| | | |
|---|--------|---|
|  | AT-A1a | 1 |
|  | AT-L32 | 2 |





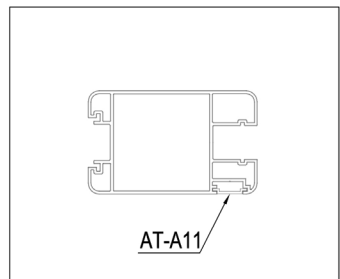
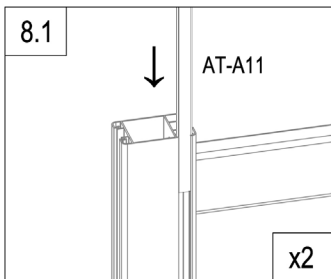
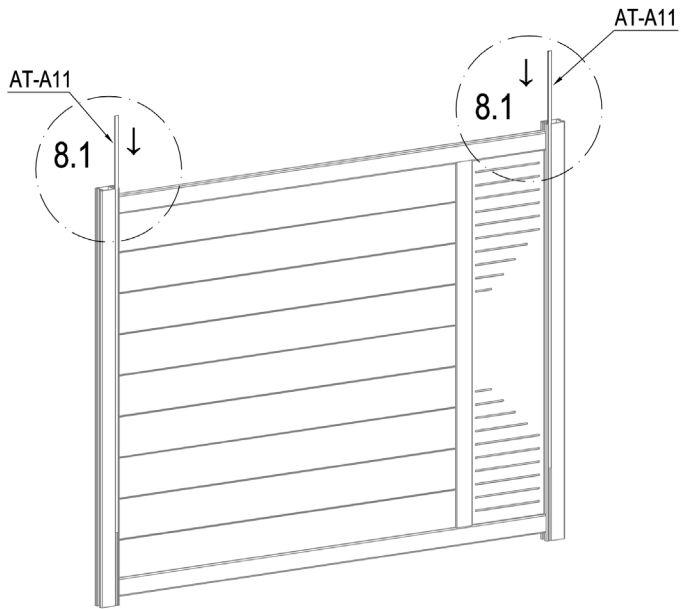

| | | |
|---|--------|----|
|  | AT-L34 | 31 |
|  | AT-L39 | 4 |

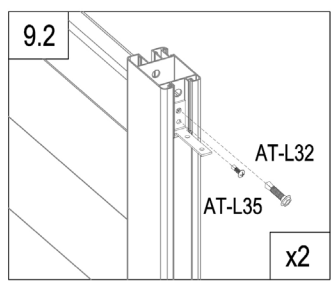
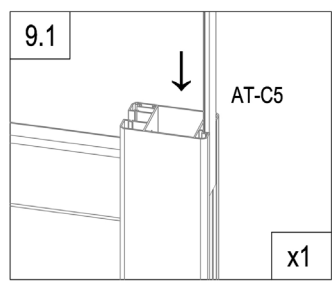
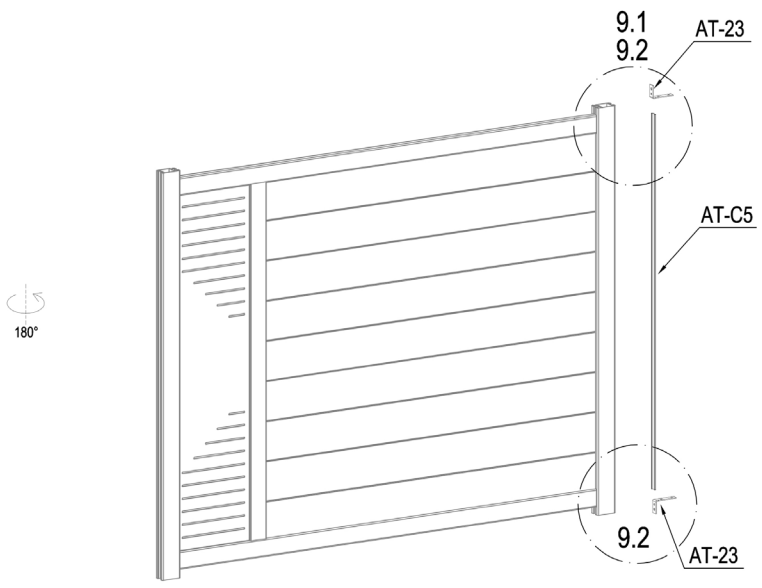

| | | |
|---|--------|---|
|  | AT-A11 | 2 |
|---|--------|---|





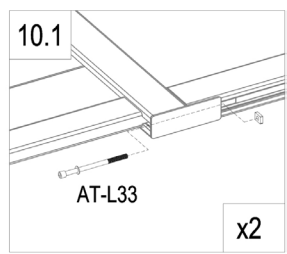
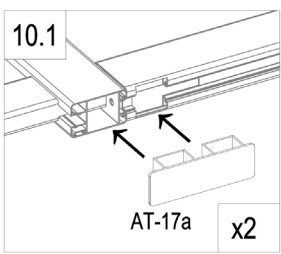
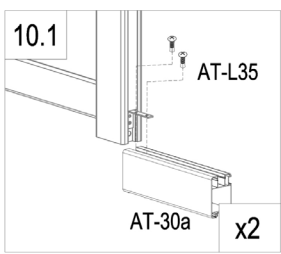
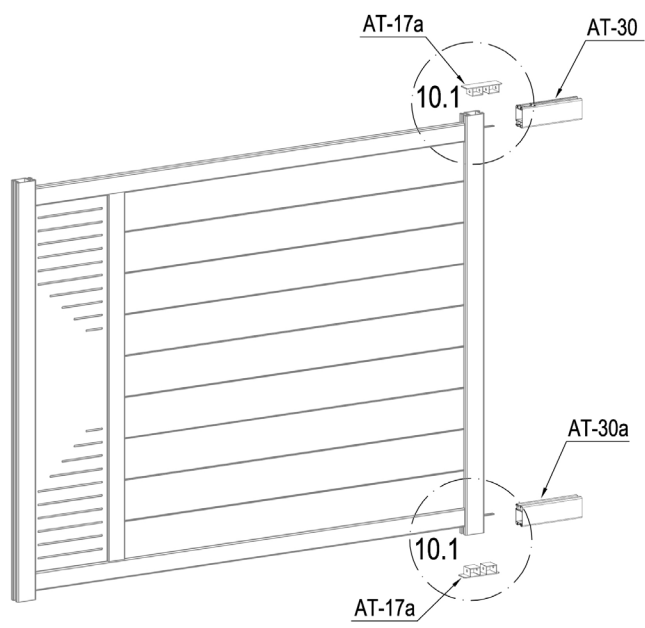

| | | |
|---|--------|---|
|  | AT-C5 | 1 |
|  | AT-23 | 2 |
|  | AT-L32 | 2 |
|  | AT-L35 | 2 |



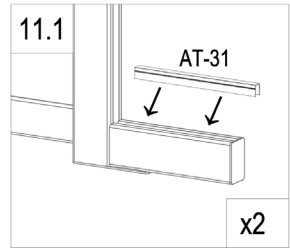
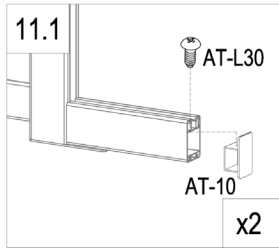
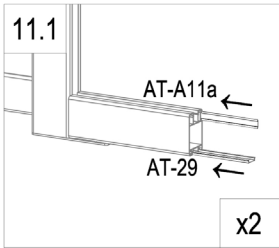
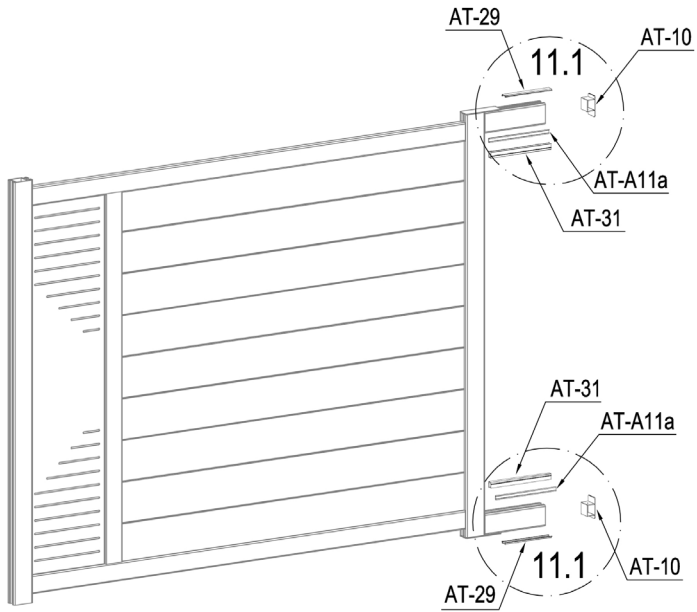

| | | |
|--|--------|---|
| | AT-30 | 1 |
| | AT-30a | 1 |
| | AT-17a | 2 |

| | | |
|--|--------|---|
| | AT-L33 | 2 |
| | AT-L35 | 4 |



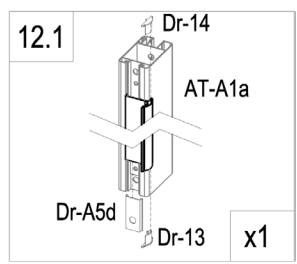
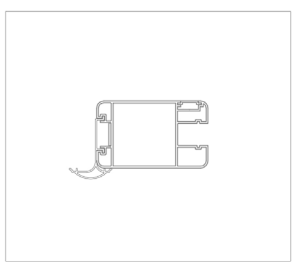
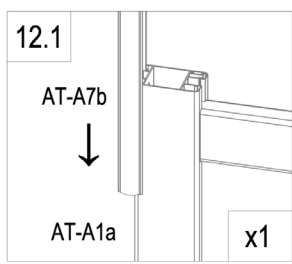
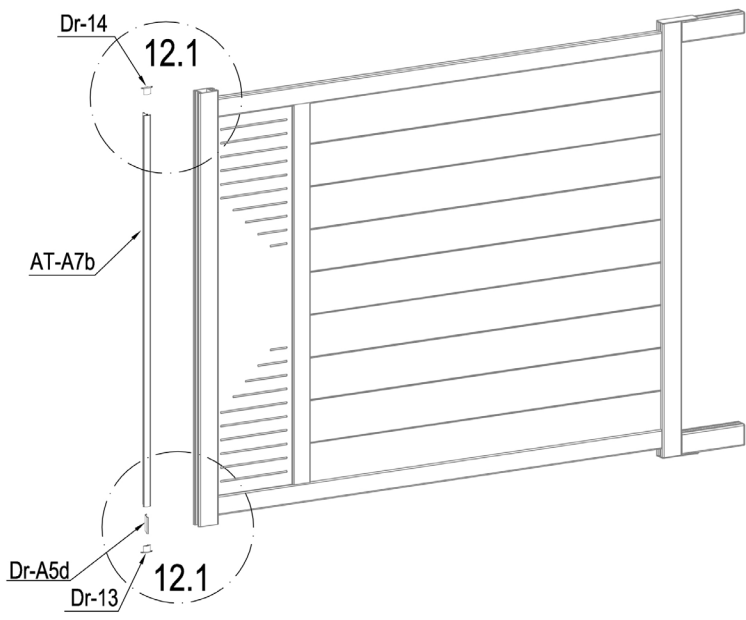

| | | |
|---|---------|---|
|  | AT-29 | 2 |
|  | AT-A11a | 2 |
|  | AT-31 | 2 |

| | | |
|---|--------|---|
|  | AT-10 | 2 |
|  | AT-L30 | 2 |

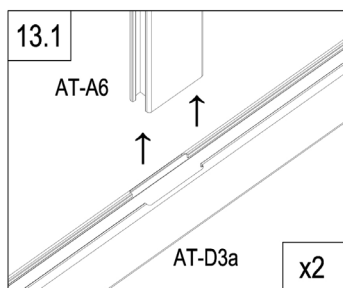
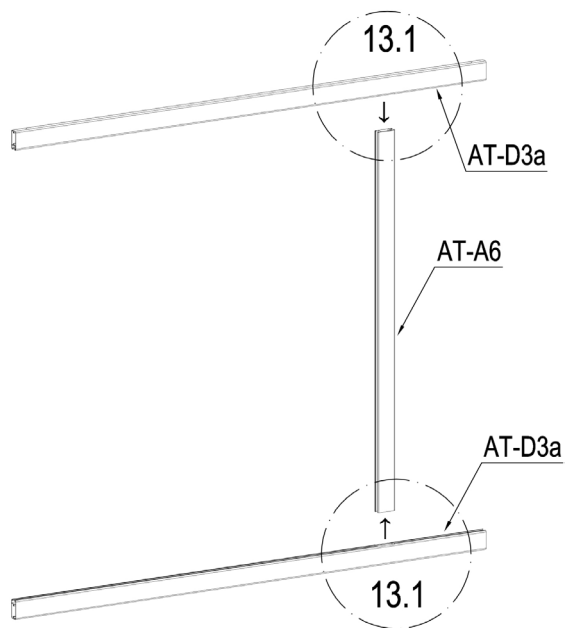

| | | |
|--|--------|---|
| | AT-A7b | 1 |
| | Dr-A5d | 1 |
| | Dr-13 | 1 |
| | Dr-14 | 1 |



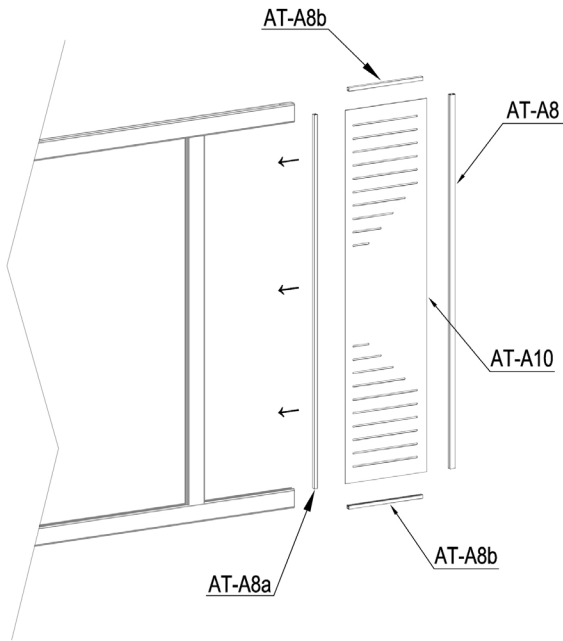

| | | |
|---|--------|---|
|  | AT-A6 | 1 |
|  | AT-D3a | 2 |



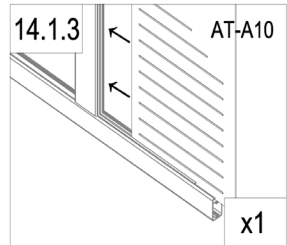
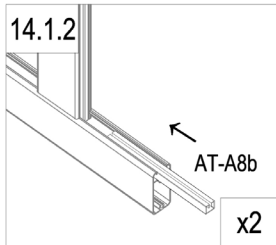
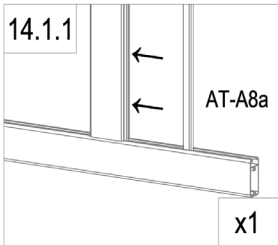



EN :you can flip and switch the direction of this plate to personalize your gate
 FR: vous pouvez retourner et changer la direction de cette plaque pour personnaliser votre portail
 DE: Sie können dieses Schild umdrehen und die Richtung wechseln, um Ihr Tor zu personalisieren.
 ES: puedes girar y cambiar la dirección de esta placa para personalizar tu puerta
 PT: pode virar e mudar a direção desta placa para personalizar o seu portão
 IT: potete capovolgere e cambiare la direzione di questa piastra per personalizzare il vostro cancello
 NL: u kunt de richting van deze plaat omdraaien en veranderen om uw poort te verpersoonlijken...
 PL: można obrócić i przełączyć kierunek tej płyty, aby spersonalizować bramę.

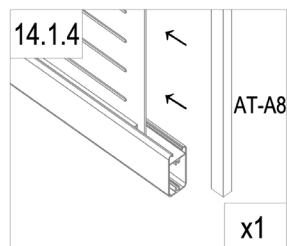

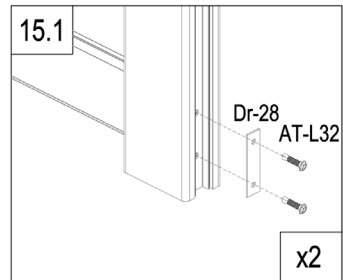
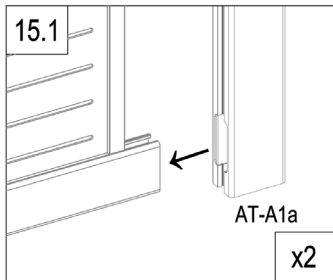
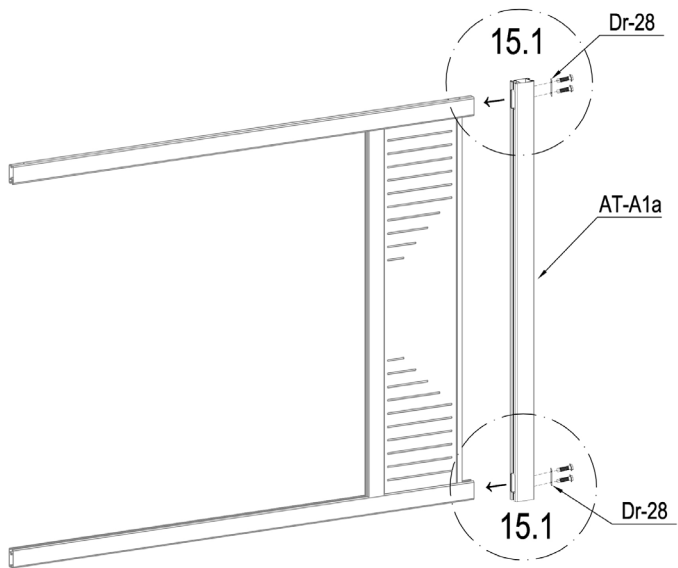
| | | |
|---|--------|---|
|  | AT-A8a | 1 |
| | AT-A8b | 2 |
|  | AT-A10 | 1 |
|  | AT-A8 | 1 |





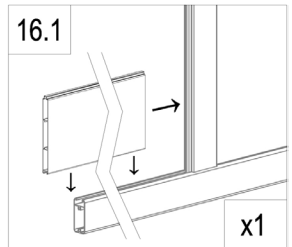
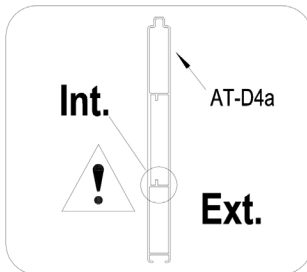
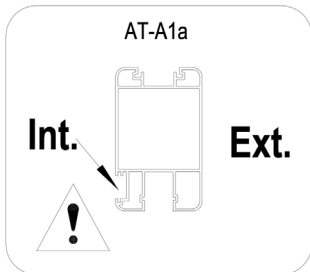
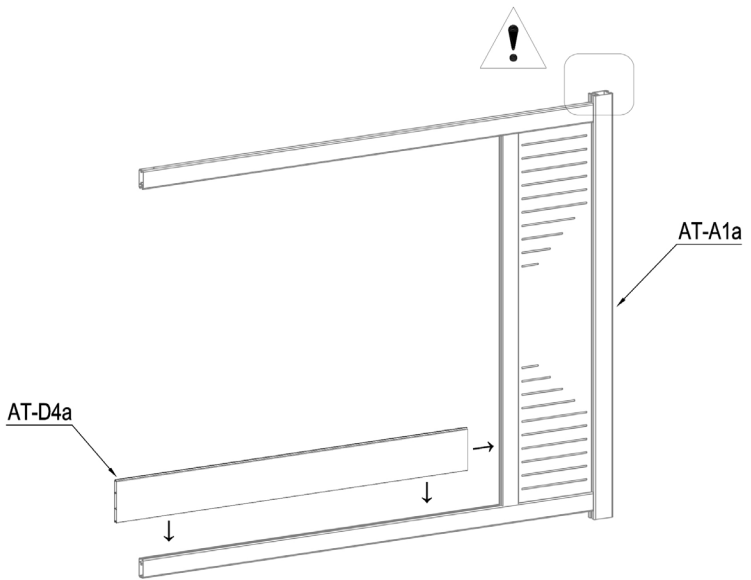

| | | |
|---|--------|---|
|  | AT-A1a | 1 |
|  | Dr-28 | 2 |
|  | AT-L32 | 4 |



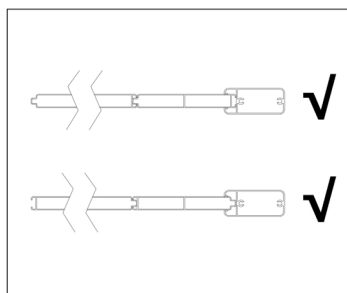
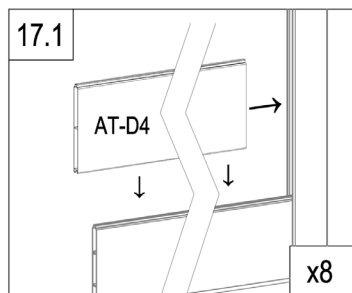
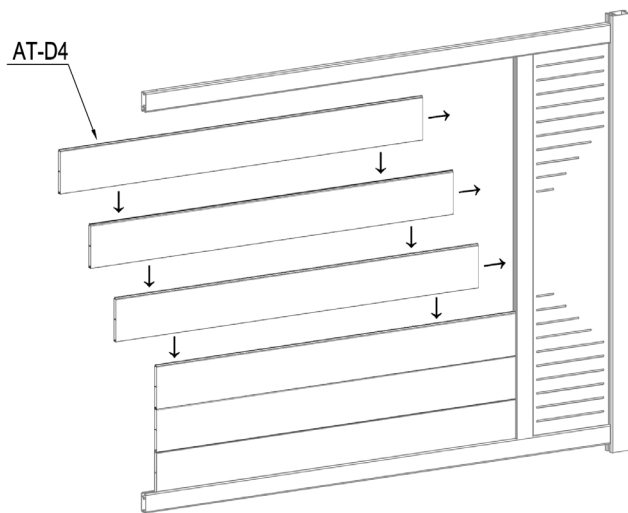

| | | |
|--|--------|---|
| | AT-D4a | 1 |
|--|--------|---|

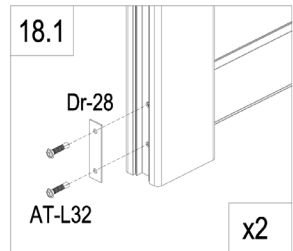
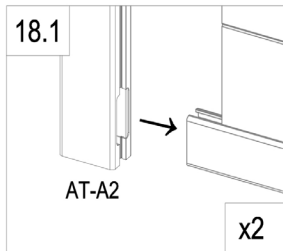
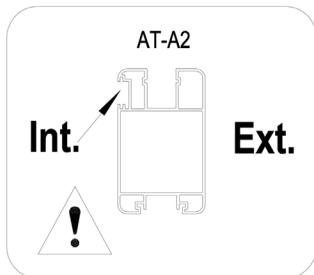
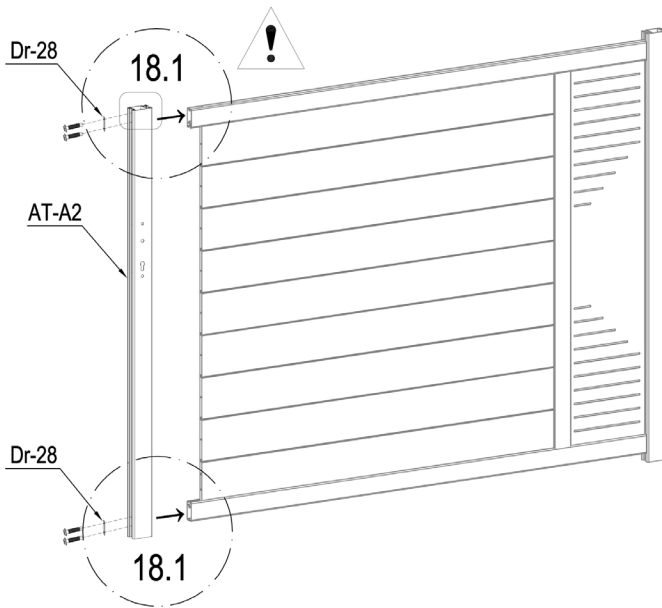

| | | |
|---|-------|---|
|  | AT-D4 | 8 |
|---|-------|---|



| | | |
|---|--------|---|
|  | AT-A2 | 1 |
|  | Dr-28 | 2 |
|  | AT-L32 | 4 |

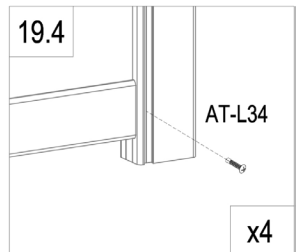
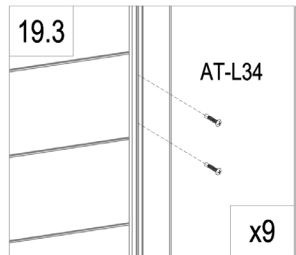
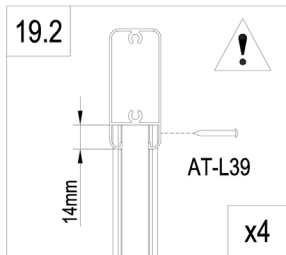
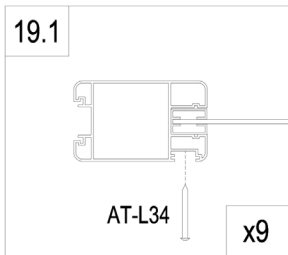
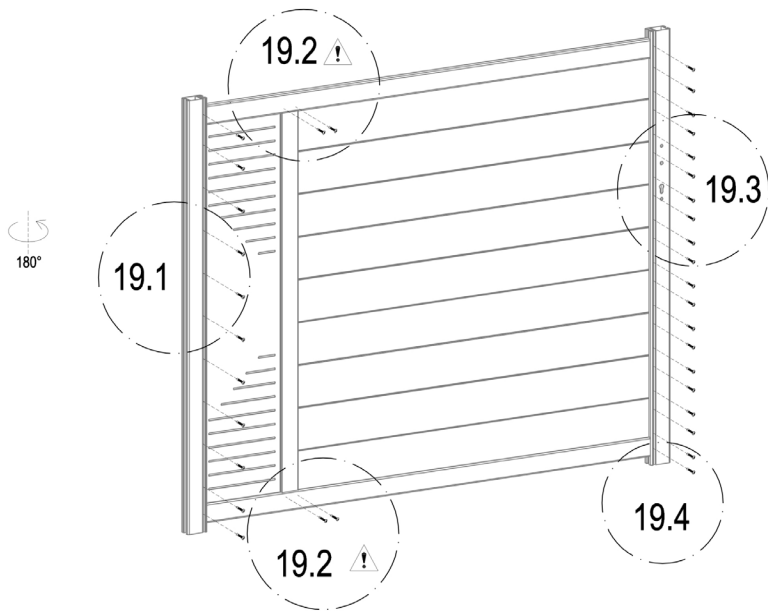

| | | |
|--|--------|----|
| | AT-L34 | 31 |
| | AT-L39 | 4 |

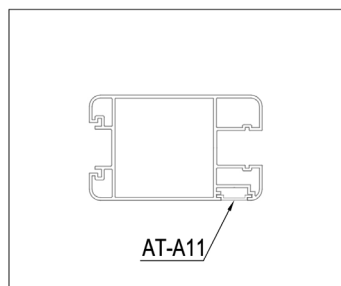
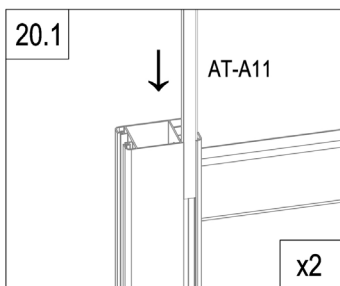
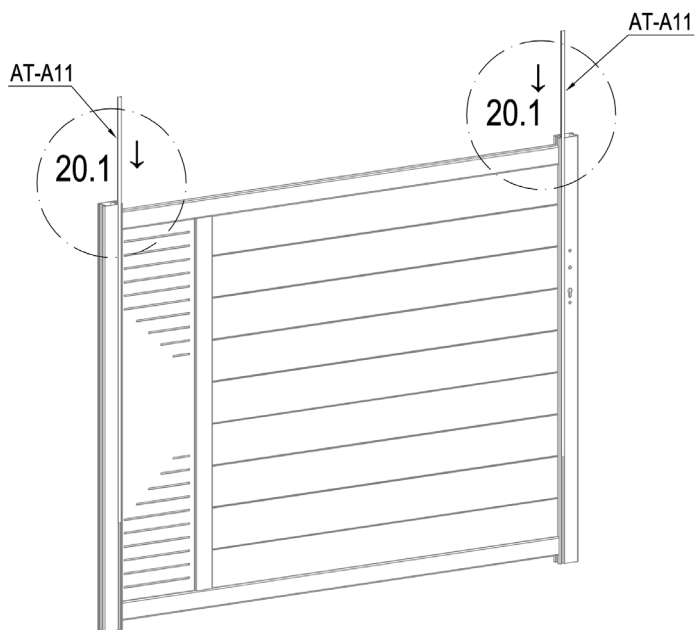

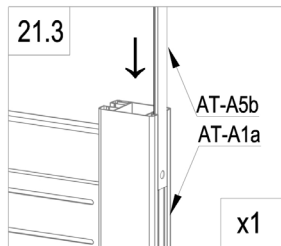
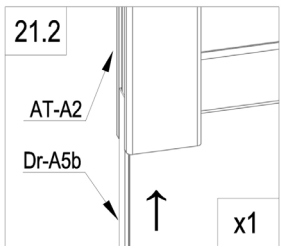
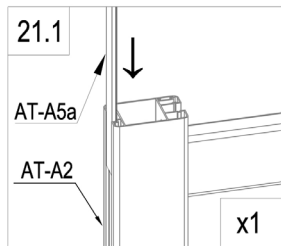
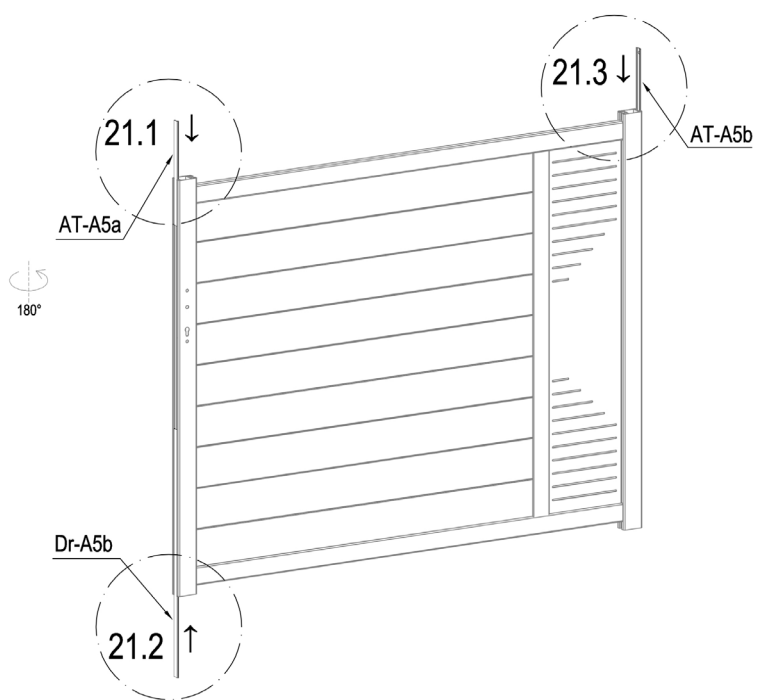

| | | |
|---|--------|---|
|  | AT-A11 | 2 |
|---|--------|---|



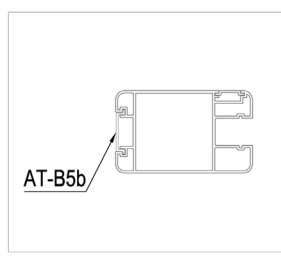

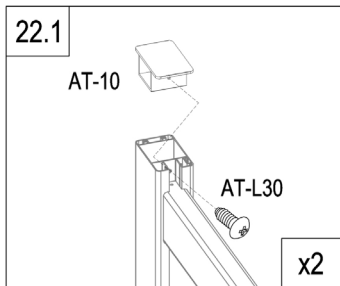
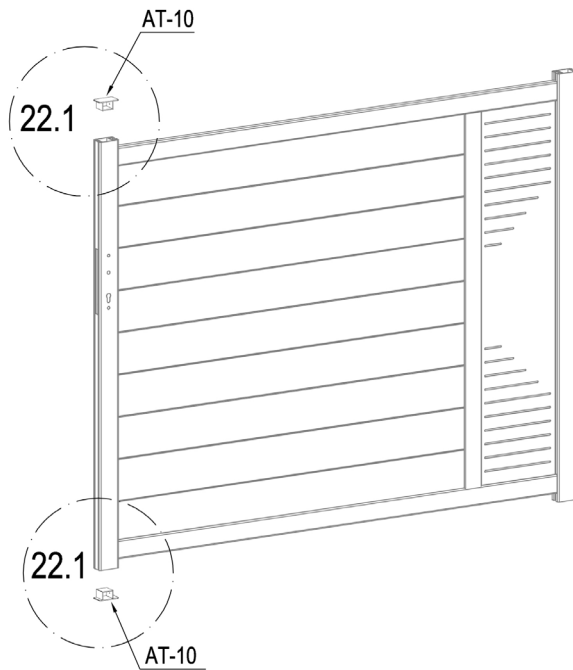
| | | |
|--|--------|---|
| | AT-A5b | 1 |
| | AT-A5a | 1 |
| | Dr-A5b | 1 |



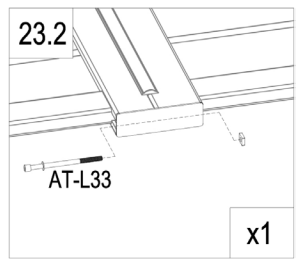
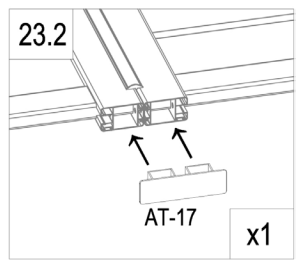
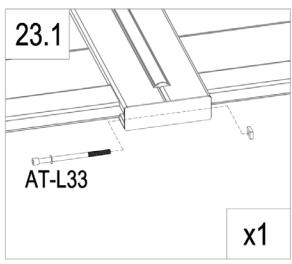
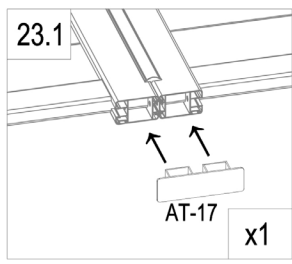
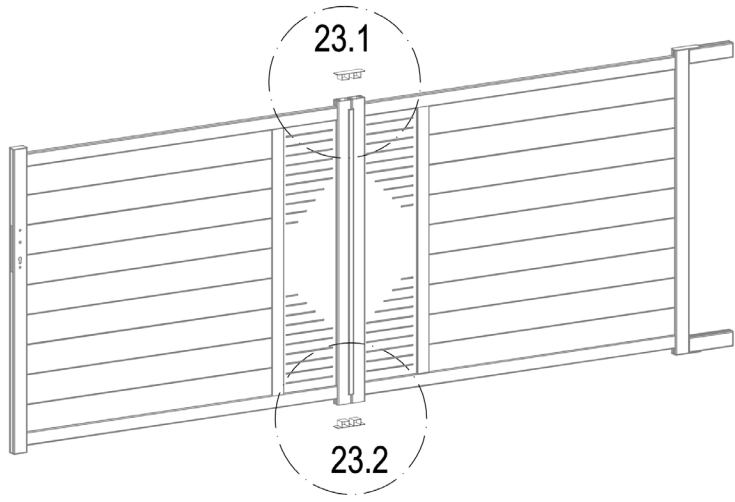

| | | |
|---|--------|---|
|  | AT-10 | 2 |
|  | AT-L30 | 2 |



| | | |
|---|--------|---|
|  | AT-17 | 2 |
|  | AT-L33 | 2 |

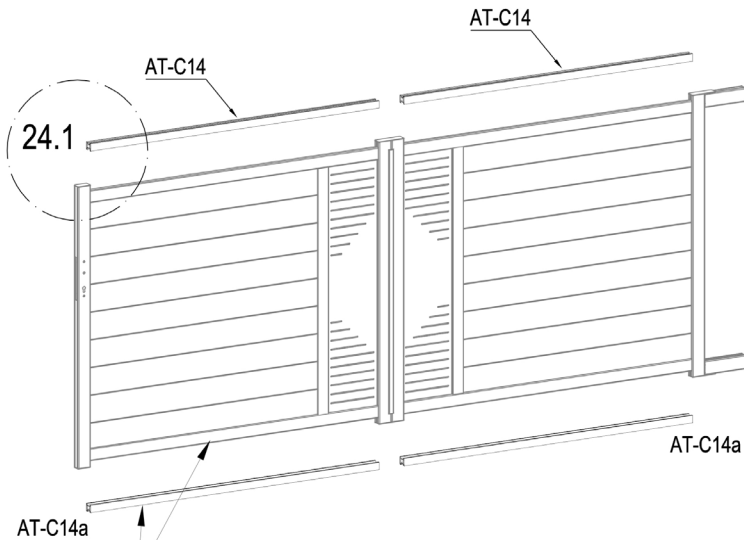

EN: These parts are made for connecting your gate's automation
 FR: Ces pièces sont faites pour relier l'automatisation de votre portail
 DE: Diese Teile sind für den Anschluss der Automatisierung Ihres Tores vorgesehen
 ES: Estas piezas están hechas para conectar la automatización de su puerta
 PT: Estas peças são feitas para ligar a automatização do seu portão
 IT: Queste parti sono realizzate per collegare l'automazione del vostro cancello
 NL: Deze onderdelen zijn gemaakt voor het aansluiten van de automatisering van uw poort.
 PL: Te części są wykonane do podłączenia automatyki bramy.

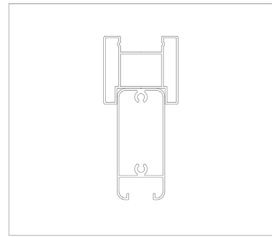
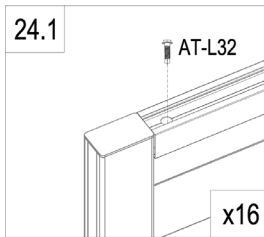
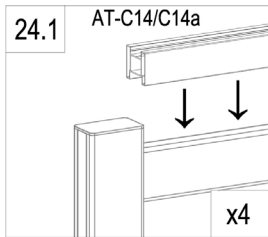

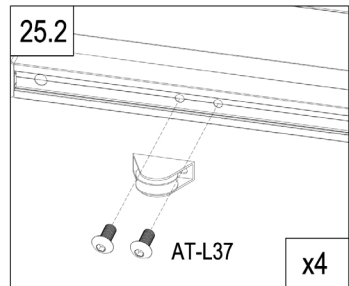
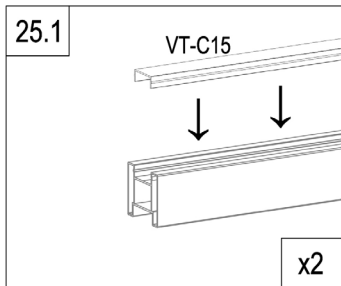
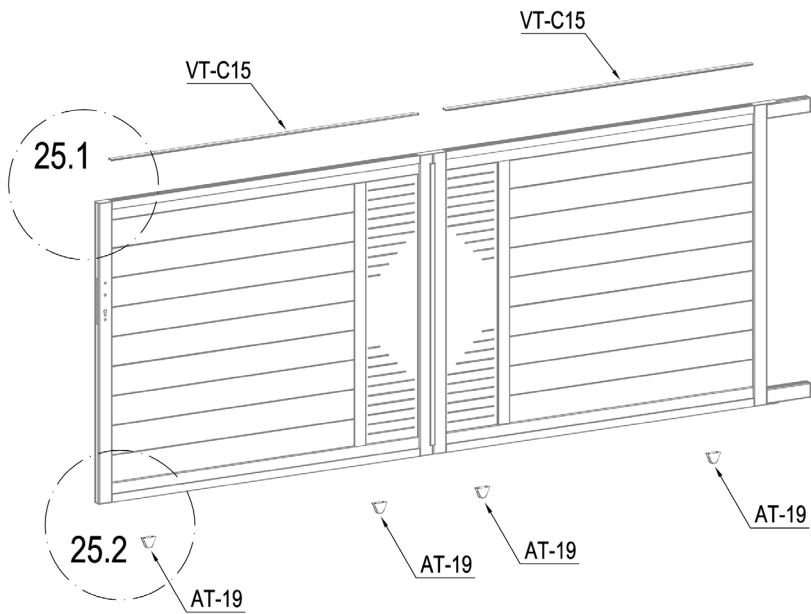

| | | |
|--|---------|----|
| | AT-C14 | 2 |
| | AT-C14a | 2 |
| | AT-L32 | 16 |

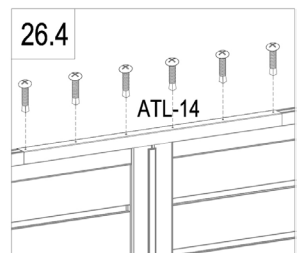
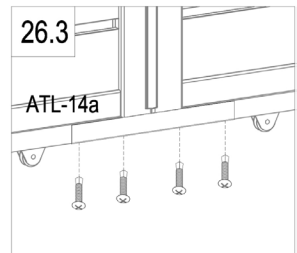
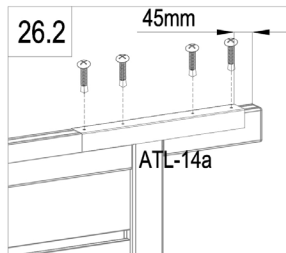
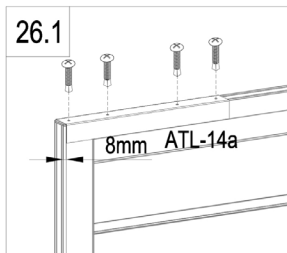
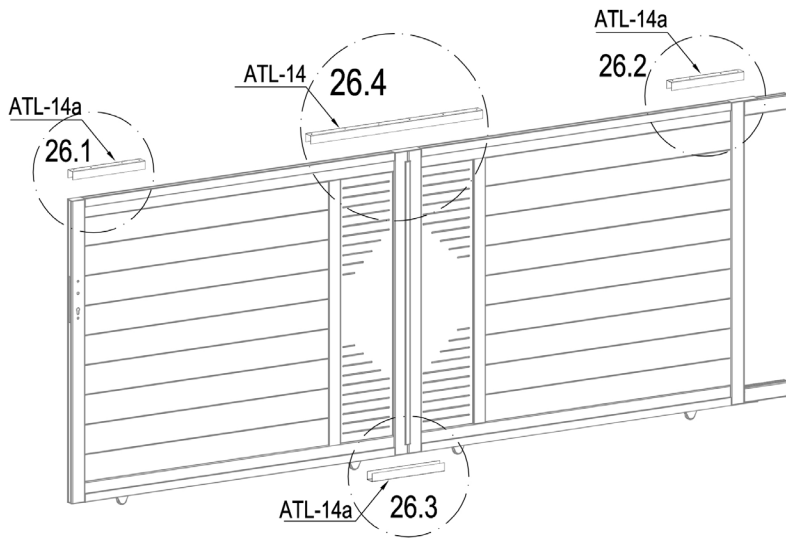

| | | |
|--|--------|---|
| | VT-C15 | 2 |
| | AT-19 | 4 |
| | AT-L37 | 8 |



| | | |
|---|---------|----|
|  | ATL-14 | 1 |
|  | ATL-14a | 3 |
|  | AT-L34 | 18 |

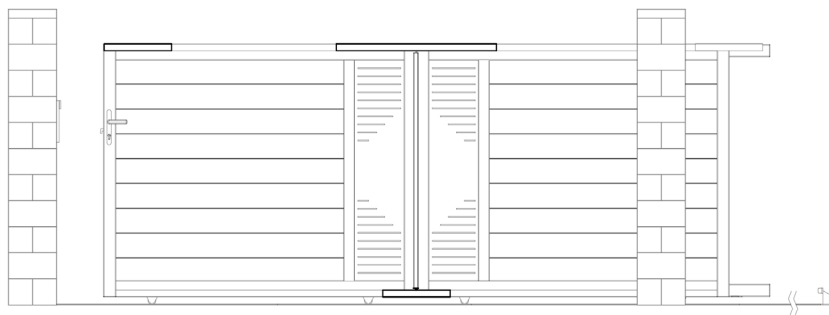

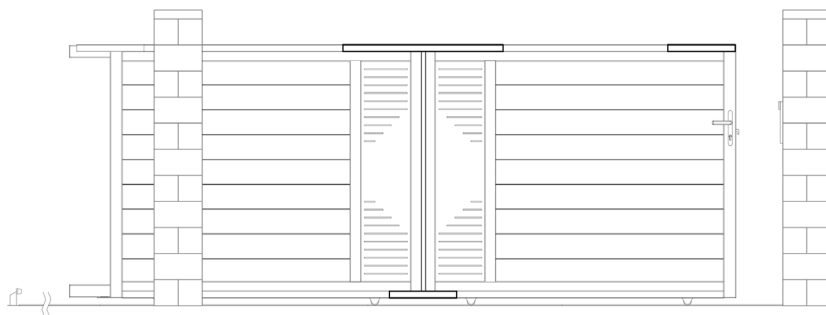

L : P27~32

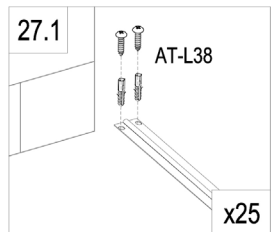
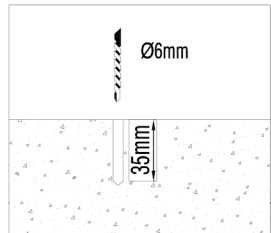
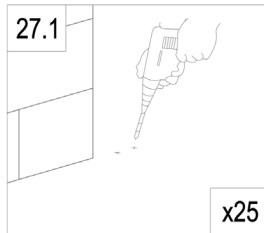
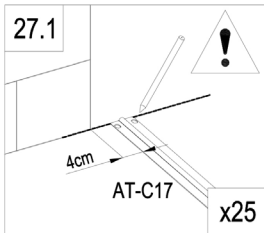
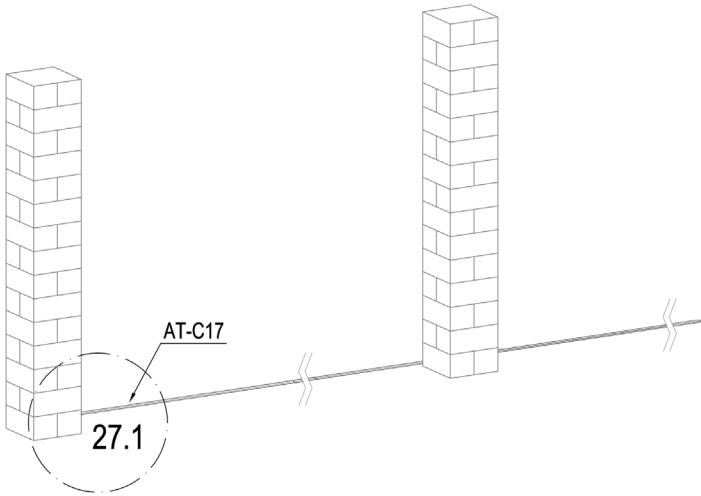

R : P33~38

L



| | | |
|---|--------|----|
|  | AT-C17 | 5 |
|  | AT-L38 | 50 |

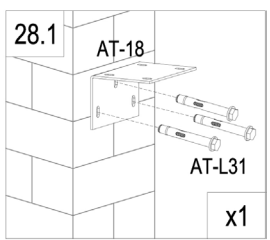
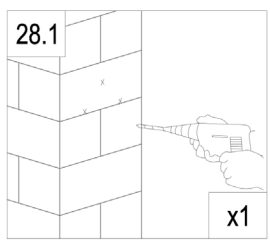
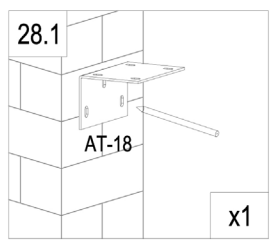
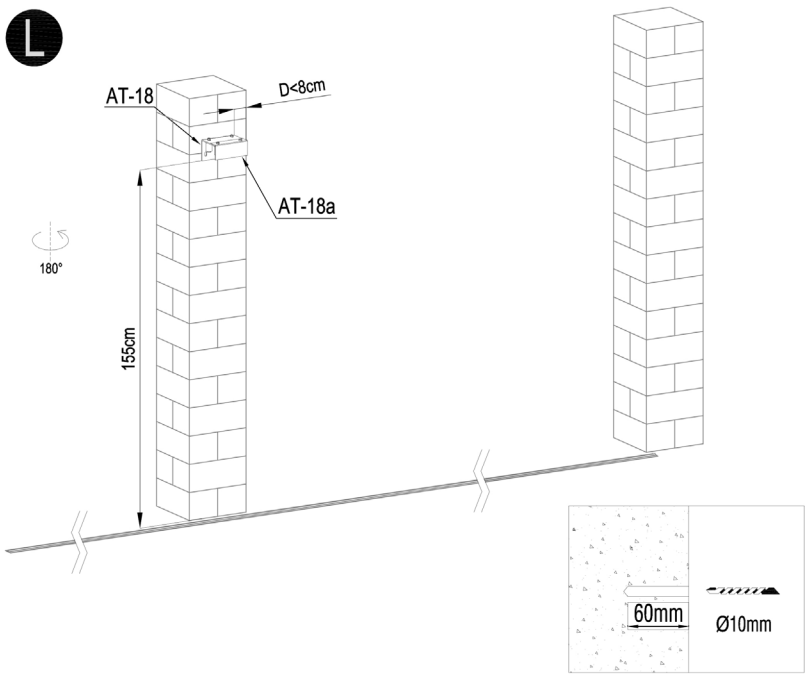

| | | |
|--|--------|---|
| | AT-18 | 1 |
| | AT-18a | 1 |
| | AT-20 | 4 |
| | AT-L31 | 3 |

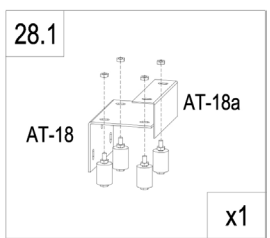
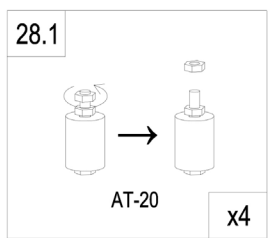

L

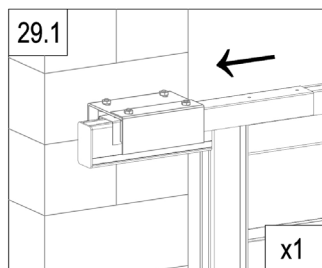
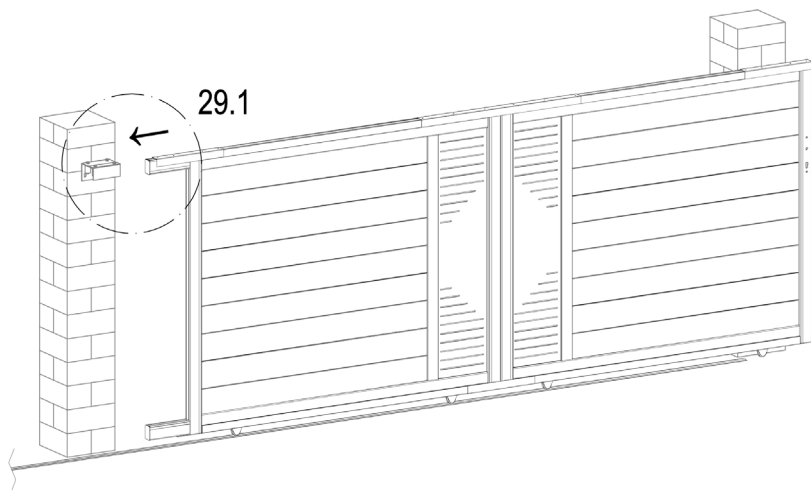

L

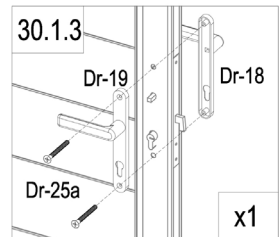
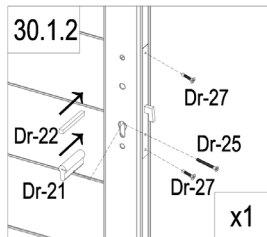
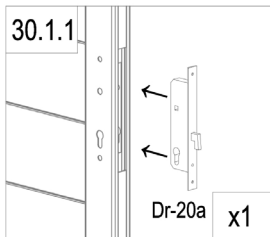
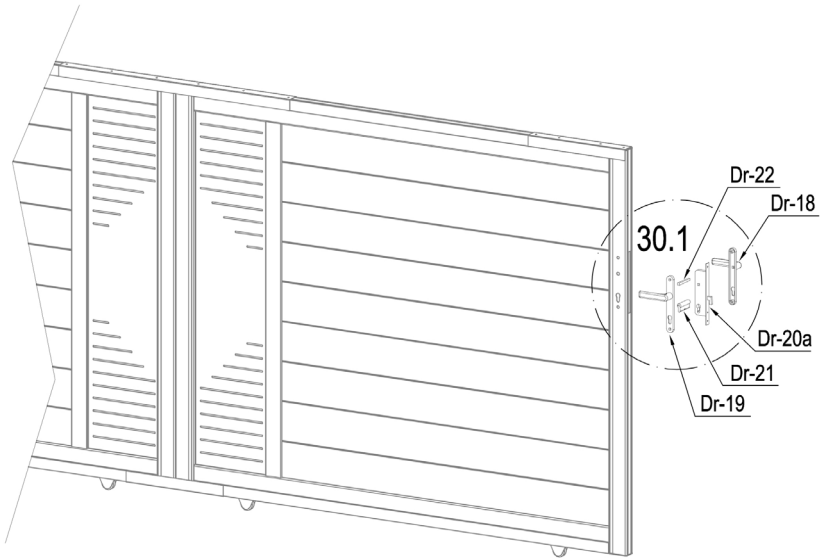

| | | |
|--|--------|---|
| | Dr-20a | 1 |
| | Dr-21 | 1 |
| | Dr-22 | 1 |
| | Dr-25 | 1 |

| | | |
|--|--------|---|
| | Dr-18 | 1 |
| | Dr-19 | 1 |
| | Dr-25a | 2 |
| | Dr-27 | 2 |

L

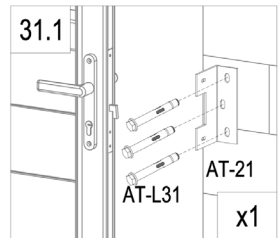
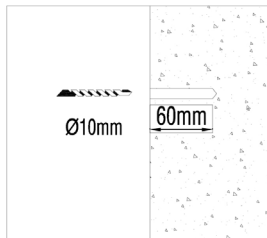
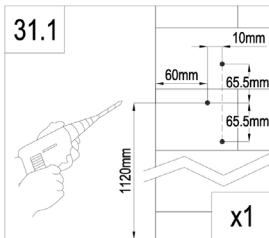
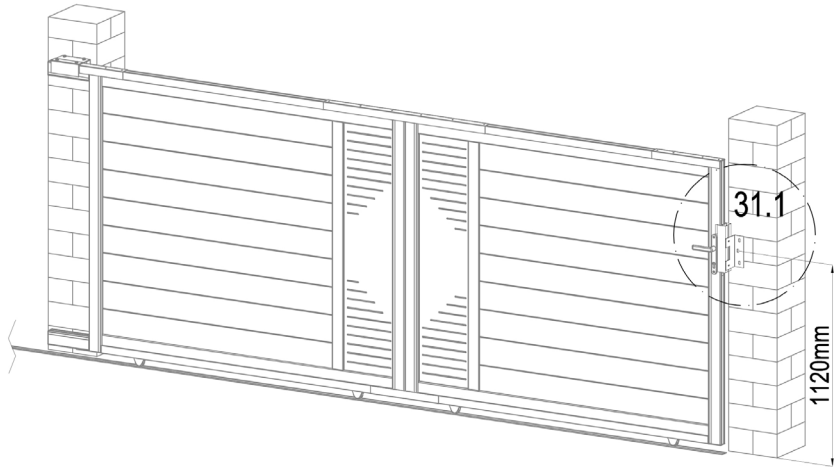

| | | |
|--|--------|---|
| | AT-16 | 1 |
| | AT-21 | 1 |
| | AT-L36 | 2 |
| | AT-L31 | 3 |
| | AT-22J | 3 |

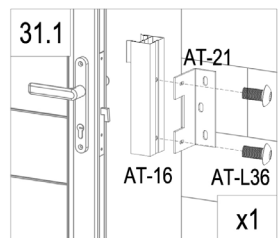
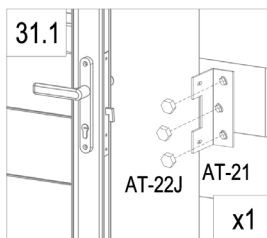

L

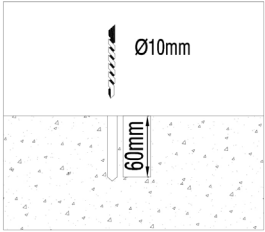
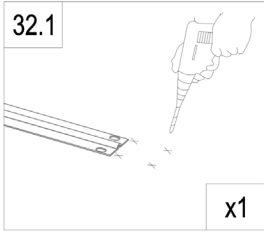
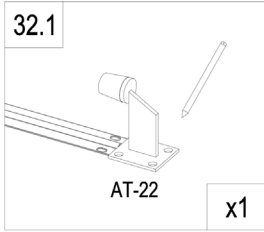
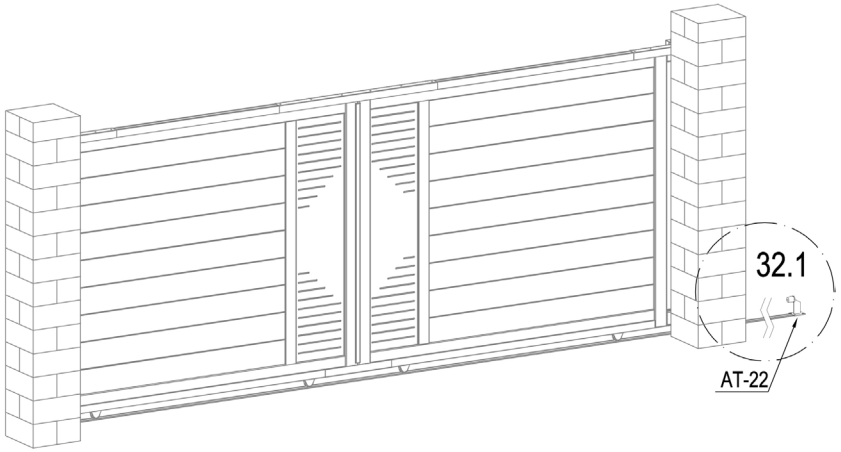

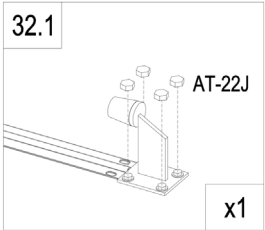
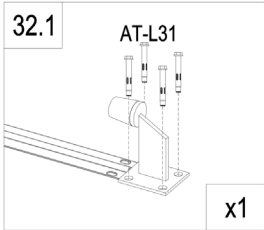

| | | |
|--|--------|---|
| | AT-22 | 1 |
| | AT-L31 | 4 |
| | AT-22J | 4 |

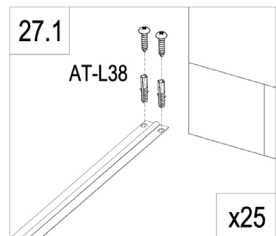
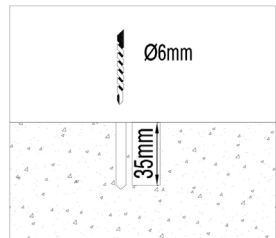
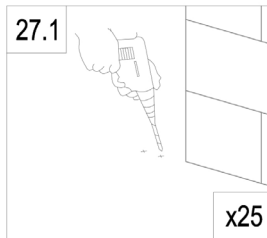
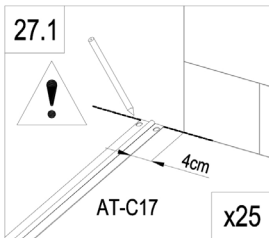
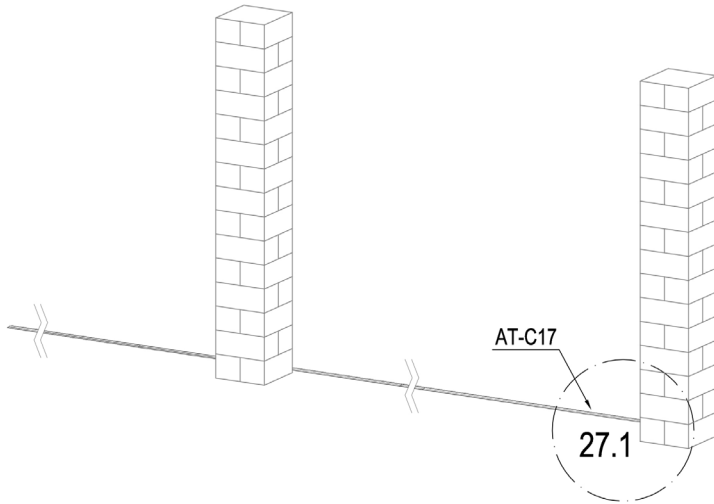

R



| | | |
|---|--------|----|
|  | AT-C17 | 5 |
|  | AT-L38 | 50 |

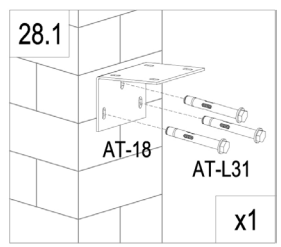
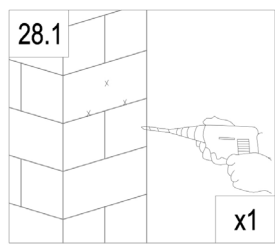
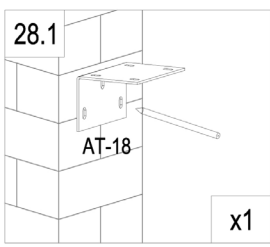
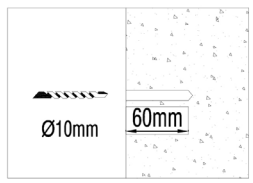
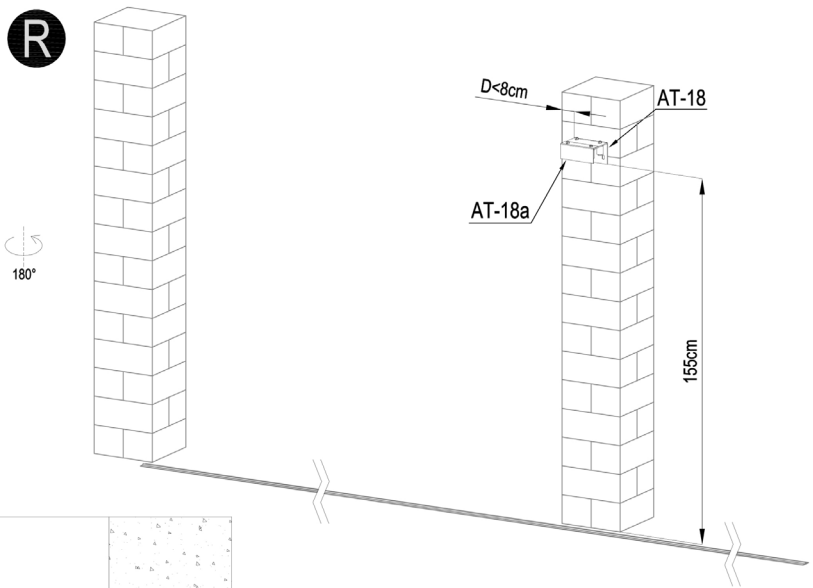

| | | |
|--|--------|---|
| | AT-18 | 1 |
| | AT-18a | 1 |
| | AT-20 | 4 |
| | AT-L31 | 3 |

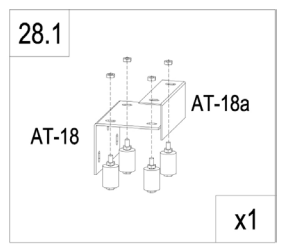
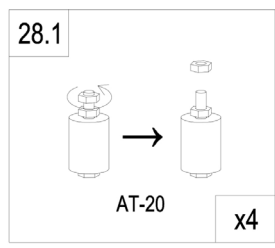

R

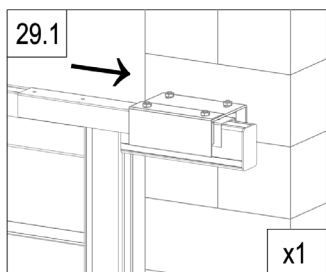
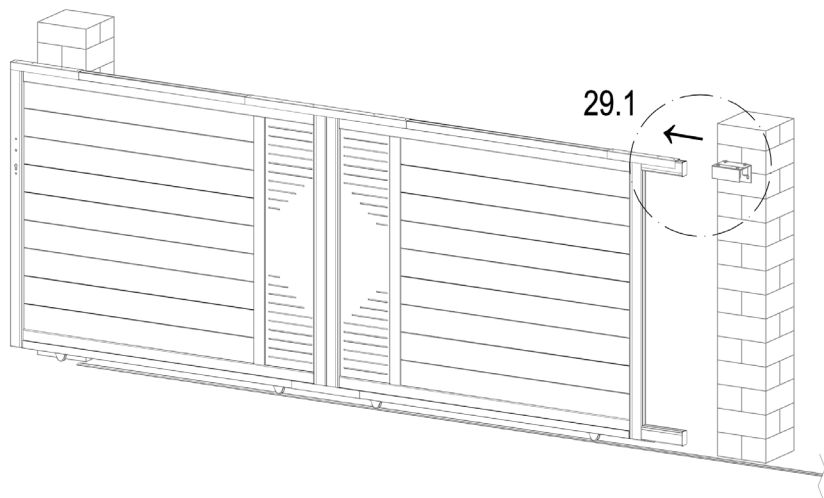

R

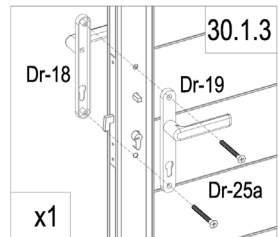
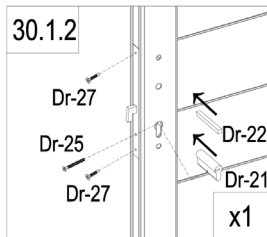
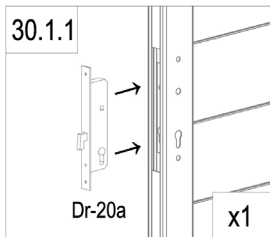
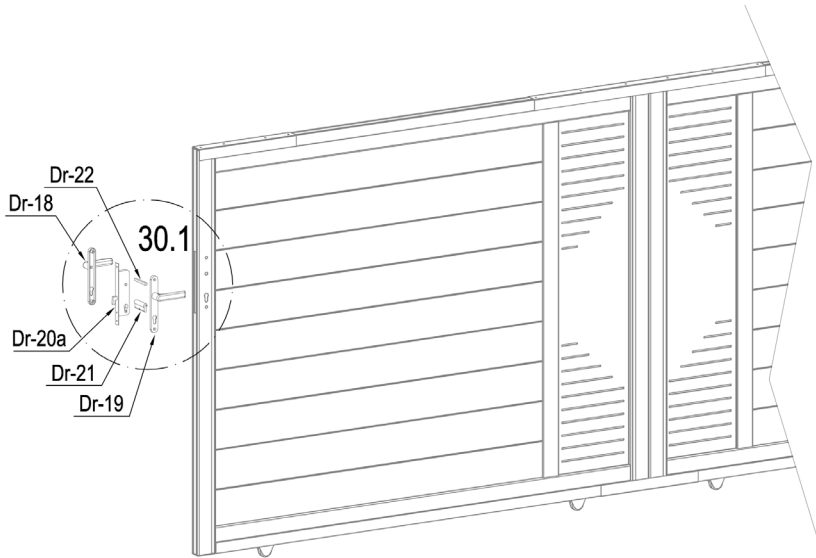

| | | |
|--|--------|---|
| | Dr-20a | 1 |
| | Dr-21 | 1 |
| | Dr-22 | 1 |
| | Dr-25 | 1 |

| | | |
|--|--------|---|
| | Dr-18 | 1 |
| | Dr-19 | 1 |
| | Dr-25a | 2 |
| | Dr-27 | 2 |

R

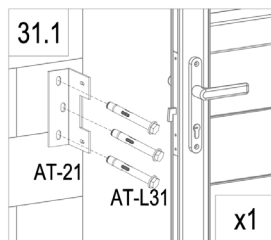
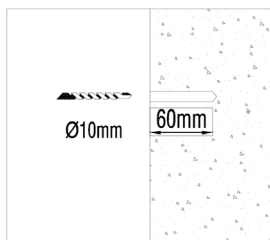
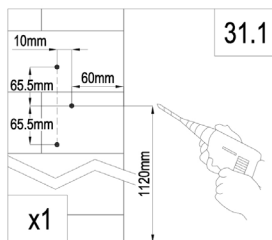
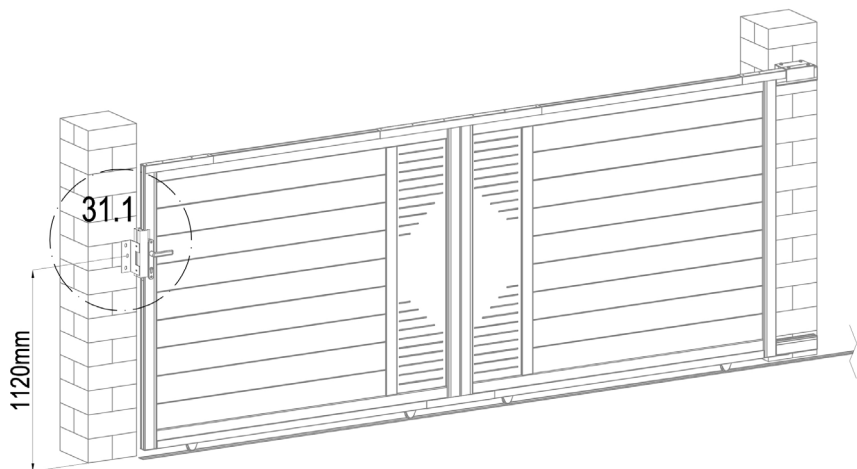

| | | |
|--|--------|---|
| | AT-16 | 1 |
| | AT-21 | 1 |
| | AT-L36 | 2 |
| | AT-L31 | 3 |
| | AT-22J | 3 |

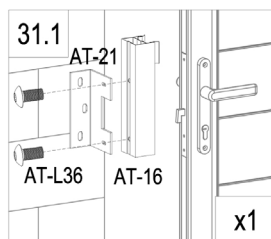
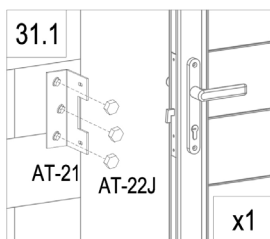

R

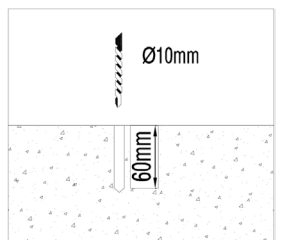
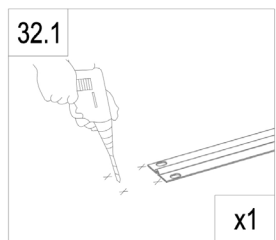
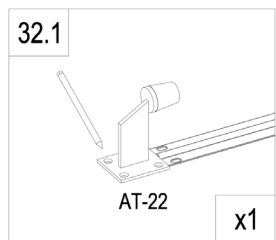
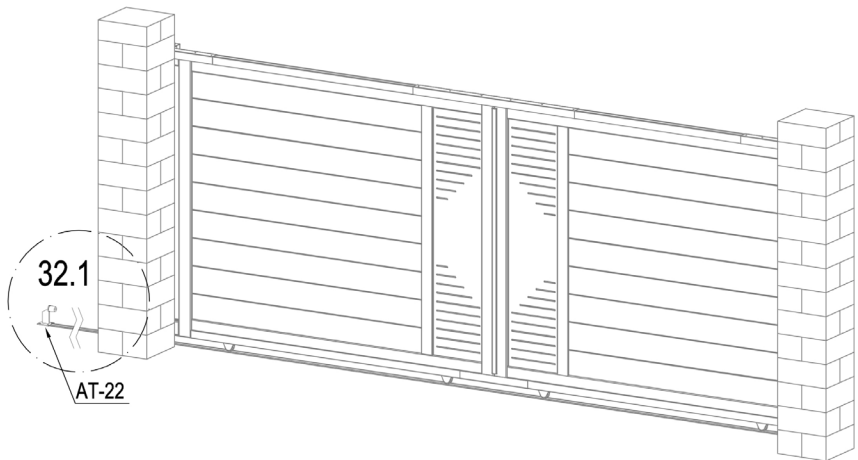

| | | |
|--|--------|---|
| | AT-22 | 1 |
| | AT-L31 | 4 |
| | AT-22J | 4 |

