

CASANOVO

EIGER 400C160

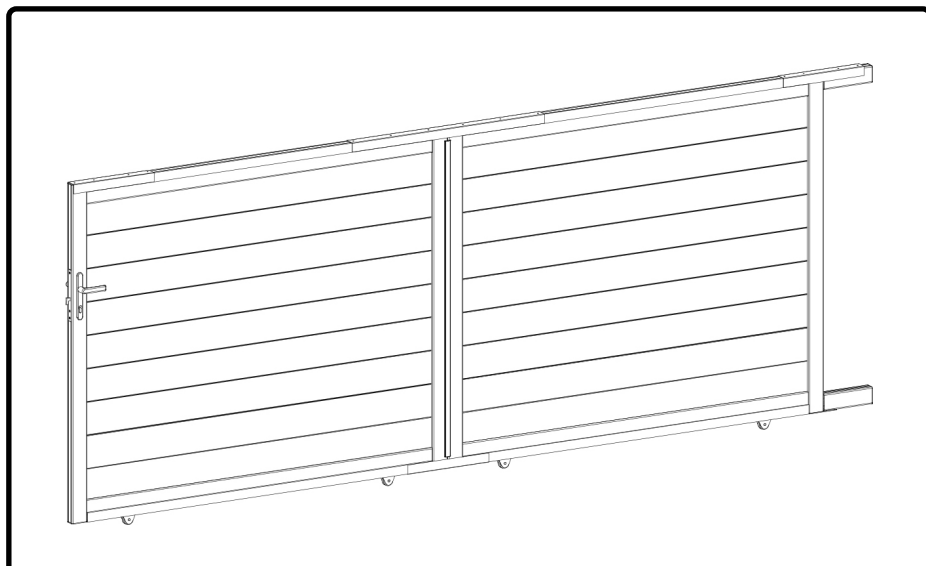

COM-000092 [x1]

COM-000094 [x1]

COM-000093 [x1]



INSTRUCTION MANUAL / NOTICE DE MONTAGE / MONTAGEANLEITUNG / MANUAL DE MONTAJE / MANUAL DE MONTAGEM / MANUALE DI MONTAGGIO /
MONTAGEHANDLEIDING / INSTRUKCJA MONTAŻU / KÄYTTÖOHJEET / BRUKSANVISNING / BRUGSANVISNING / INSTRUCIUNI DE ASAMBLARE /
NAVODILA ZA SESTAVLJANJE / NÁVOD NA MONTÁŽ / ÖSSZESZERELÉSI ÚTMUTATÓ / NÁVOD K MONTÁŽI / UPUTE ZA INSTALACIJU /
ΟΔΗΓΙΕΣ ΣΥΝΑΡΜΟΛΟΓΗΣΗΣ / SURINKIMO INSTRUKCIJOS / MONTŽAS INSTRUKCIJAS

Ext.

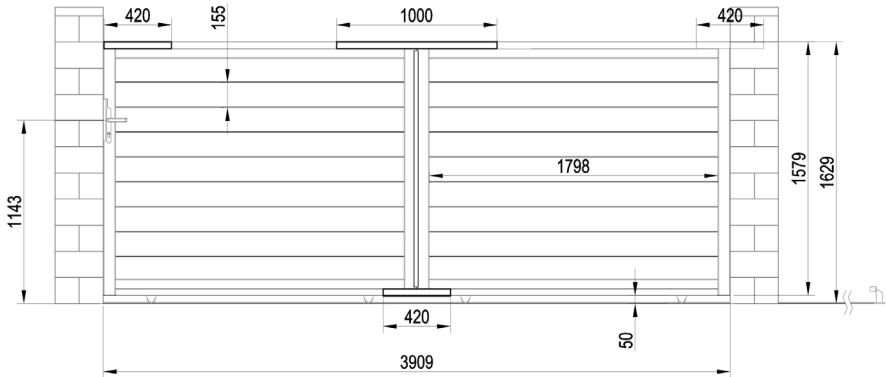

Int.

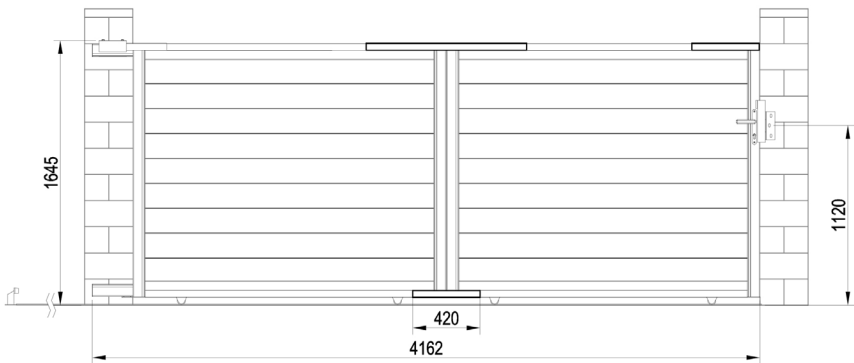

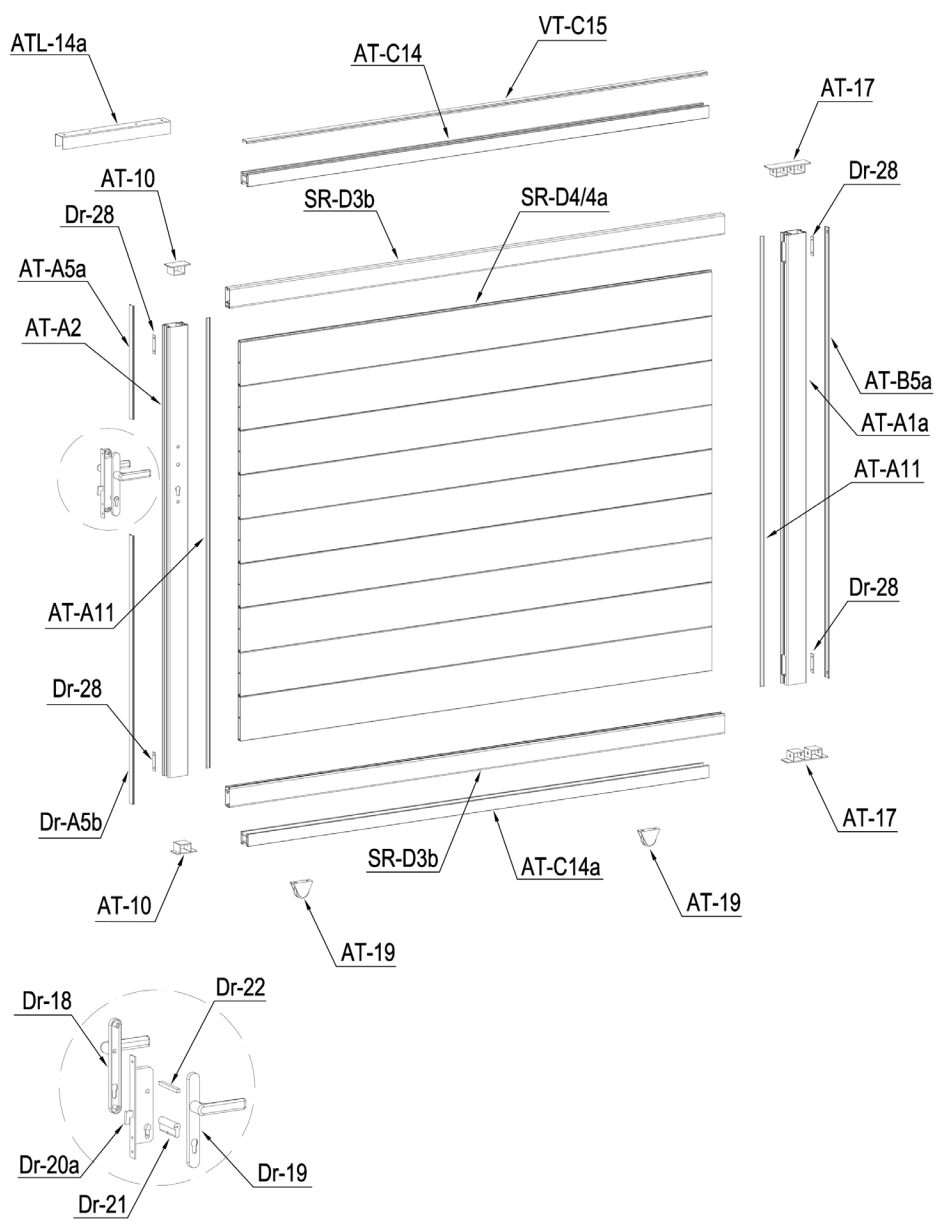

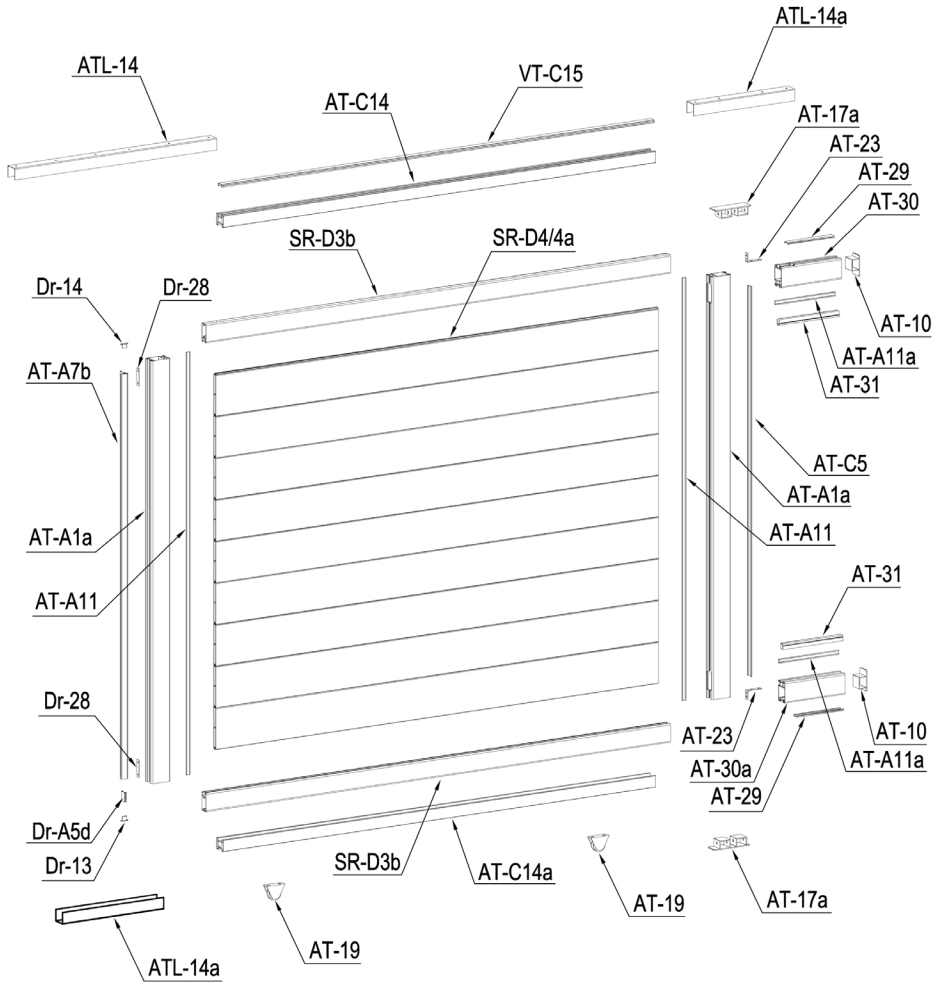

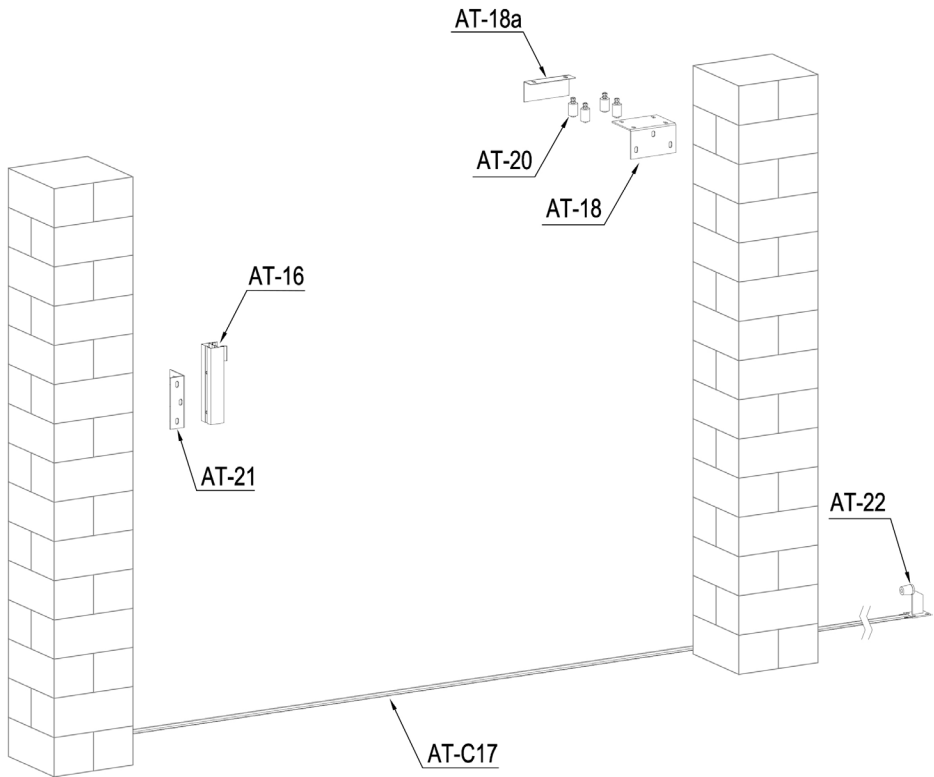

















































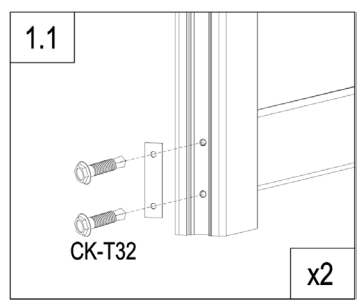
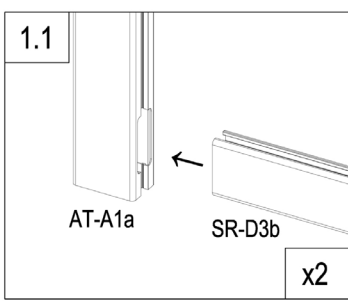
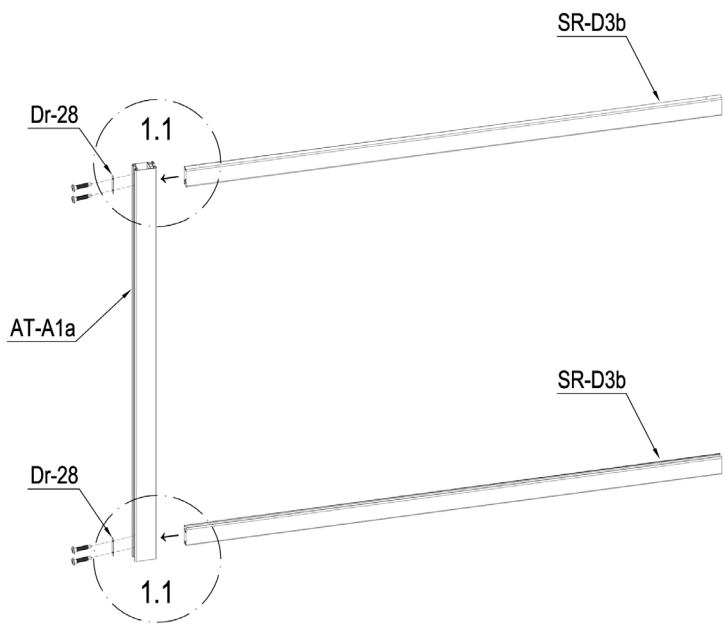

PART LIST

IMAGE	NO.	L.(mm)	QTY	IMAGE	NO.	L.(mm)	QTY
	AT-A1a	1573	3		Dr-14		1
	AT-A2	1573	1		Dr-18		1
	AT-30	250	1		Dr-19		1
	AT-30a	250	1		Dr-20a		1
	SR-D3b	1931	4		Dr-21		1
	SR-D4	1840	16		Dr-22		1
	SR-D4a	1840	2		Dr-25		1
	AT-A5b	1573	1		Dr-25a		2
	AT-C5	1448	1		Dr-27		2
	AT-A5a	395.5	1		AT-18		1
	Dr-A5b	937	1		AT-18a		1
	AT-29	193	2		AT-19		4
	Dr-A5d	52	1		AT-20		4
						AT-21	
	AT-A11	1573	4		AT-22		1
	AT-A11a	250	2		AT-23		2
	AT-31	250	2		Dr-28		6
	AT-A7b	1468	1		AT-22J		7
	AT-C14	1798	2		CK-T30		4
	AT-C14a	1798	2		CK-T31		10
	VT-C15	1797	2		CK-T32		32
	AT-16	260	1		CK-T33		4
	AT-C17	1580	5		CK-T34		91
	ATL-14	1000	1		CK-T35		6
	ATL-14a	420	3		CK-T36		2
	AT-17		2		CK-T37		8
	AT-17a		2		CK-T38		50
	AT-10		4				
	Dr-13		1				

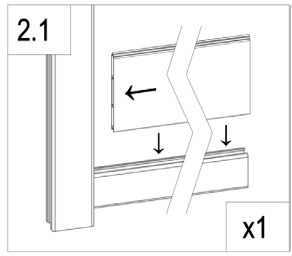
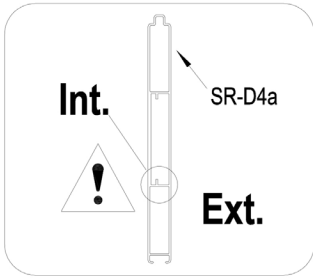
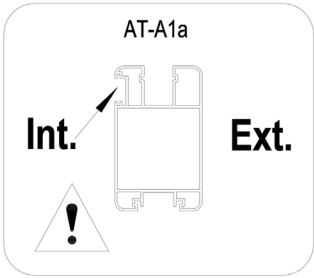
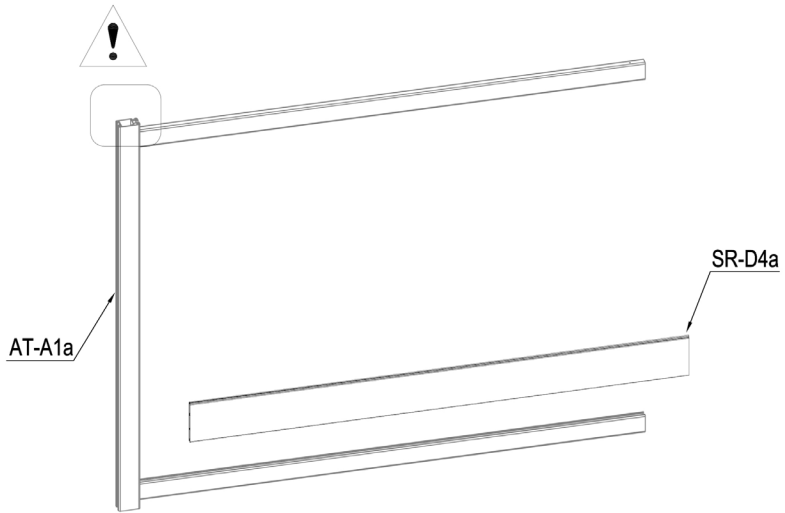

	AT-A1a	1
	SR-D3b	2
	Dr-28	2
	CK-T32	4



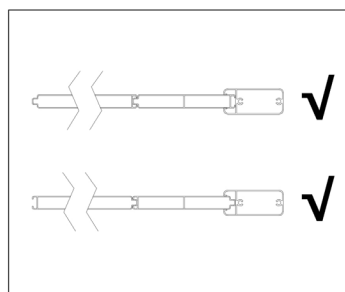
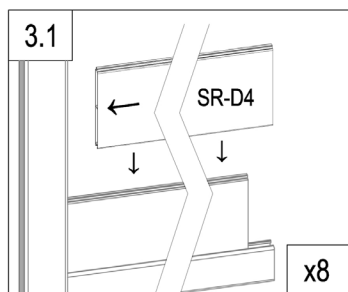
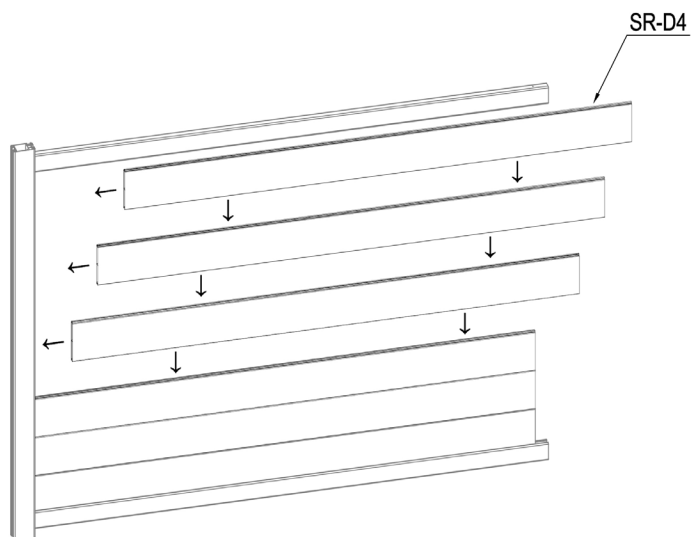

	SR-D4a	1
---	--------	---

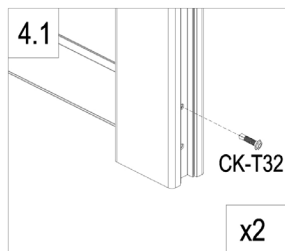
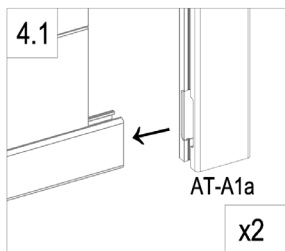
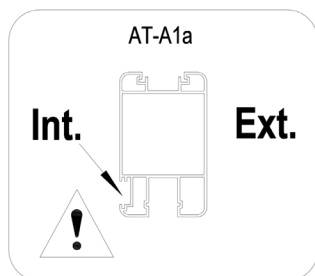
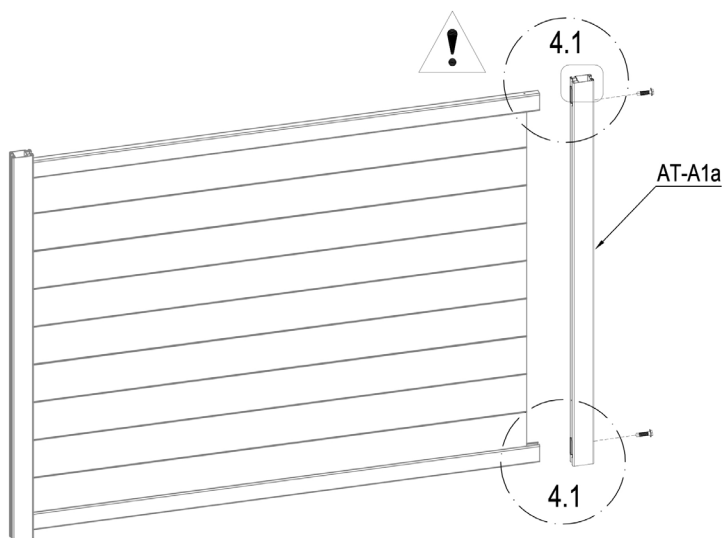

	SR-D4	8
---	-------	---



	AT-A1a	1
	CK-T32	2

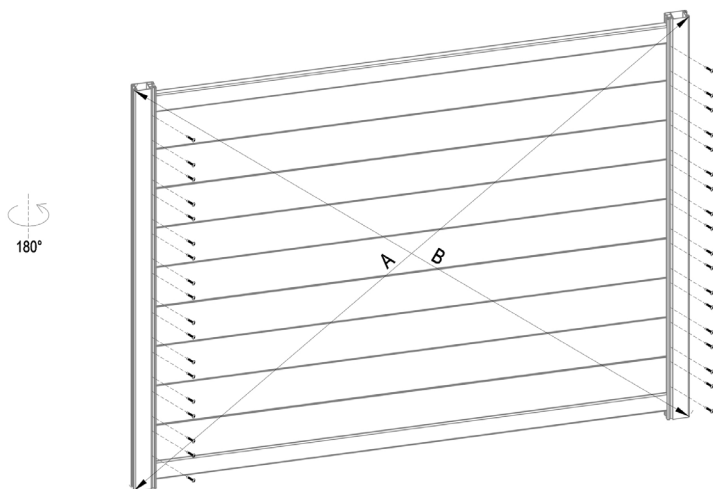

A=B

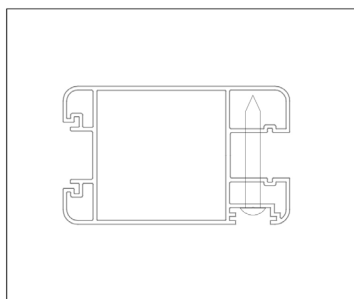
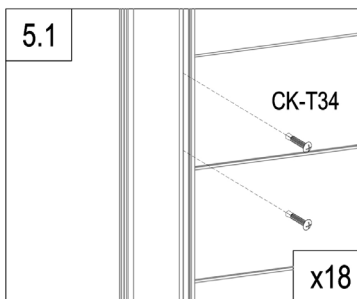

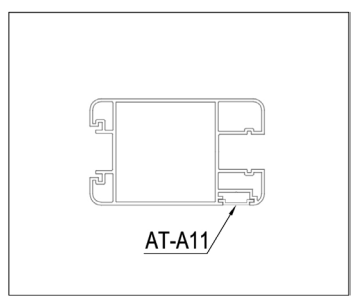
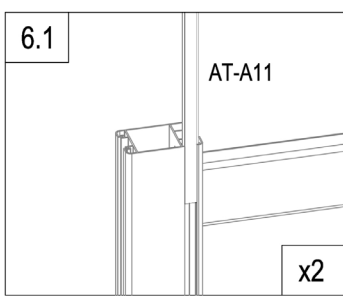
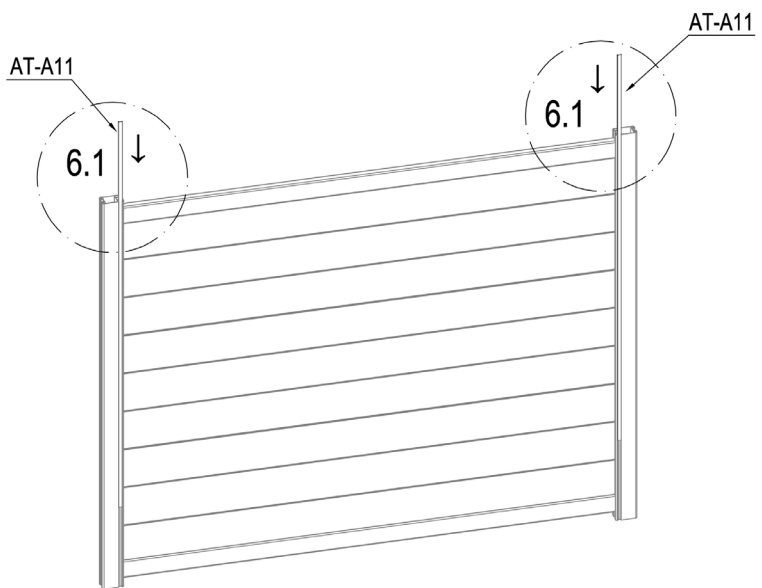

	CK-T34	36
---	--------	----

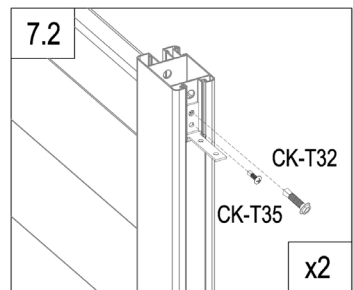
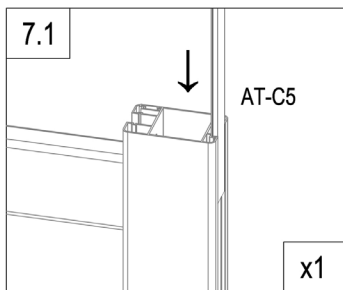
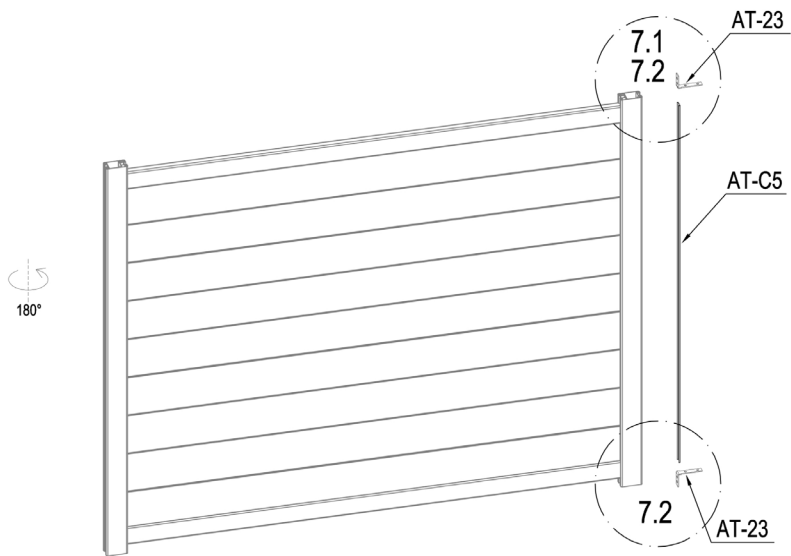

	AT-A11	2
---	--------	---





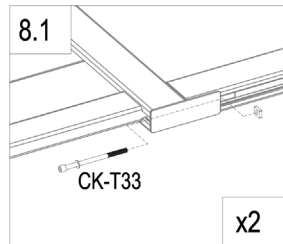
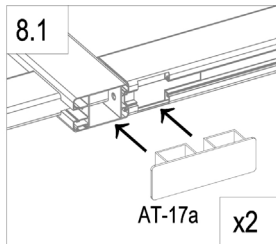
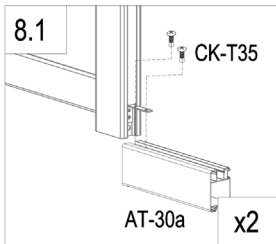
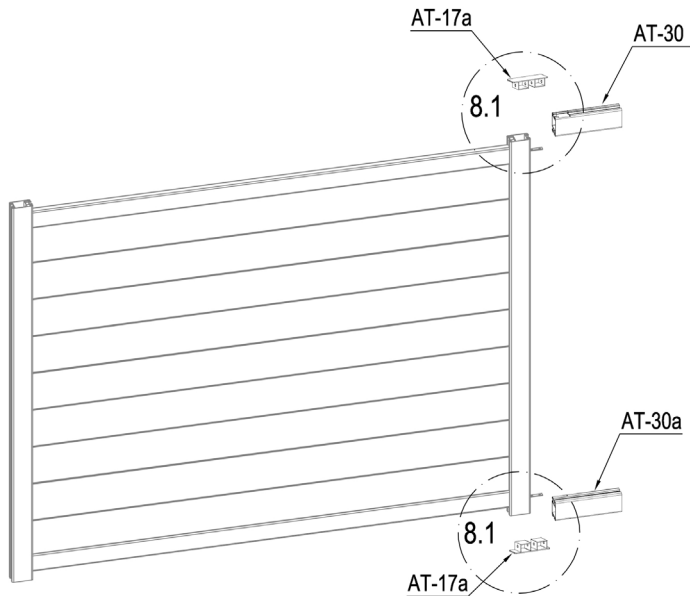

	AT-C5	1
	AT-23	2
	CK-T32	2
	CK-T35	2



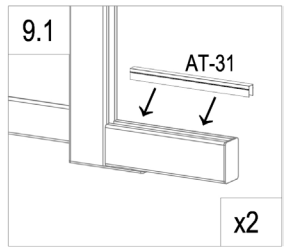
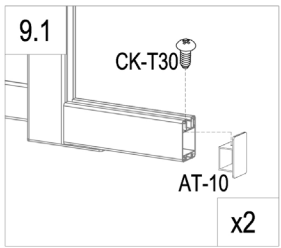
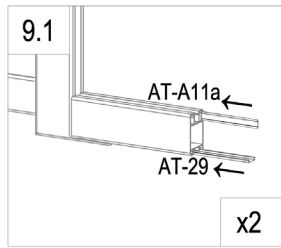
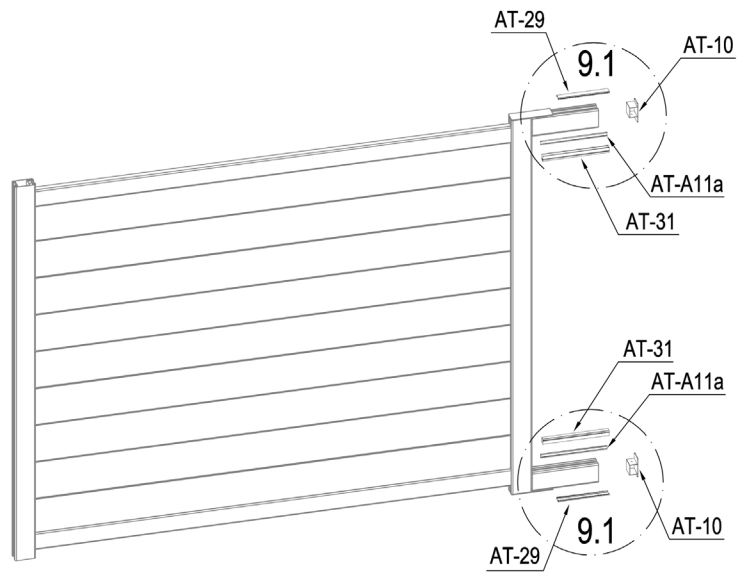

	AT-30	1
	AT-30a	1
	AT-17a	2

	CK-T33	2
	CK-T35	4





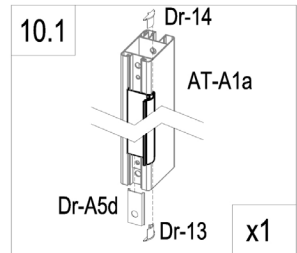
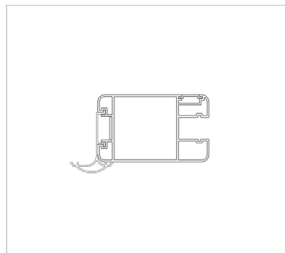
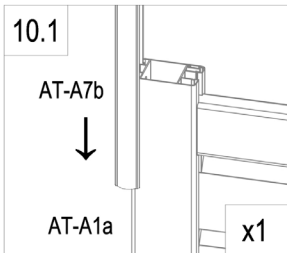
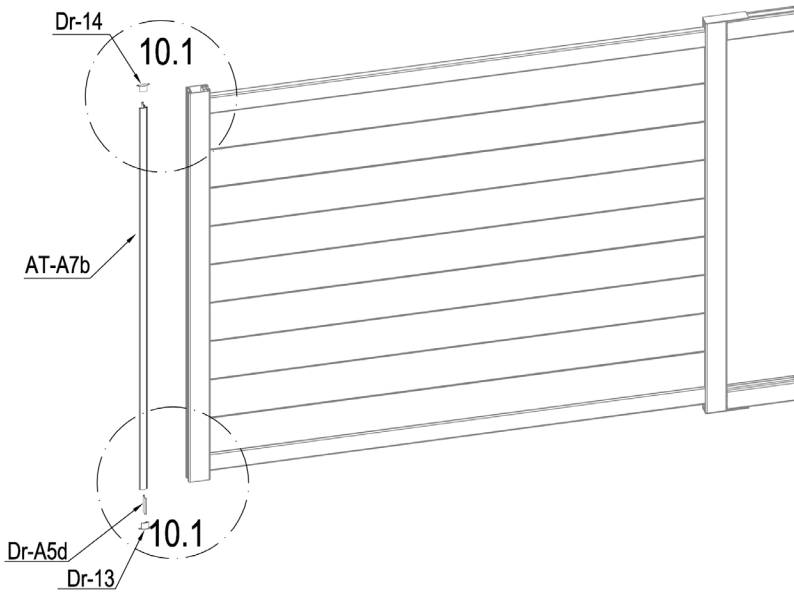

	AT-29	2
	AT-A11a	2
	AT-31	2

	AT-10	2
	CK-T30	2

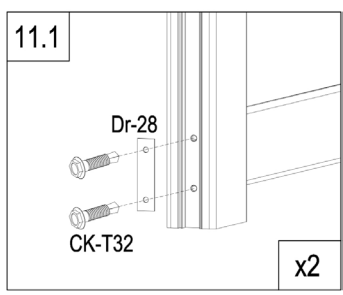
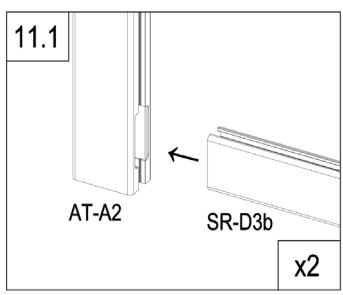
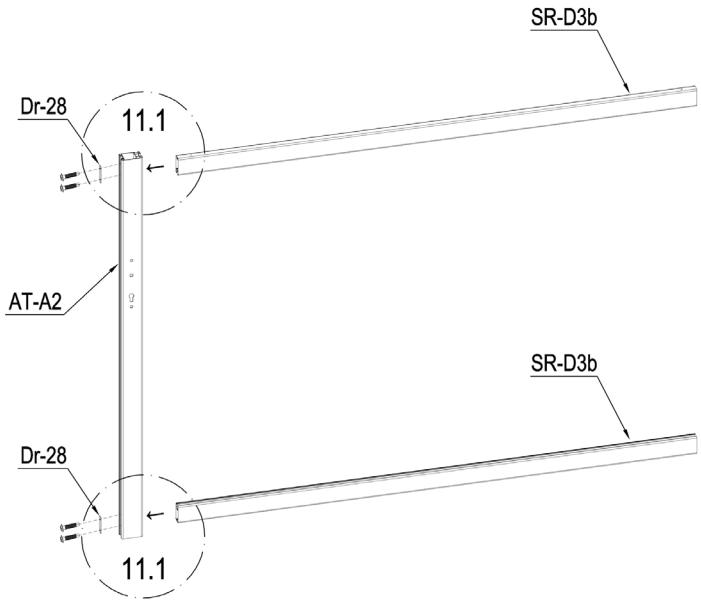

	AT-A7b	1
	Dr-A5d	1
	Dr-13	1
	Dr-14	1



	AT-A2	1
	SR-D3b	2
	Dr-28	2
	CK-T32	4

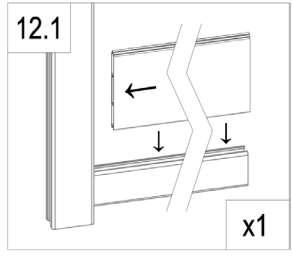
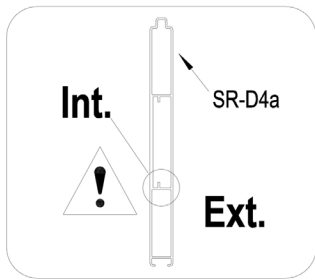
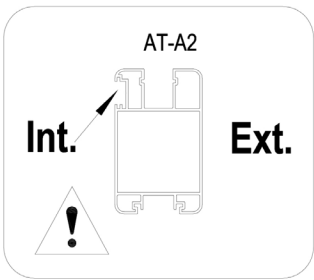
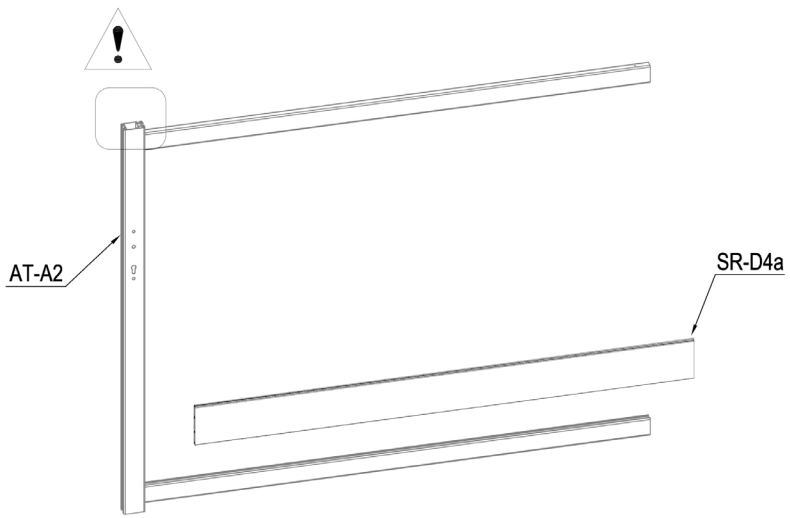

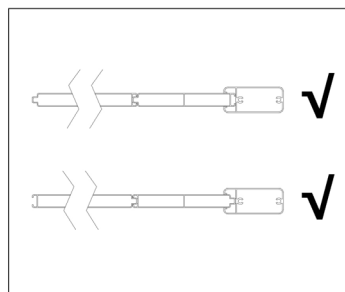
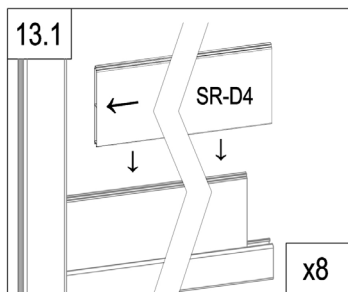
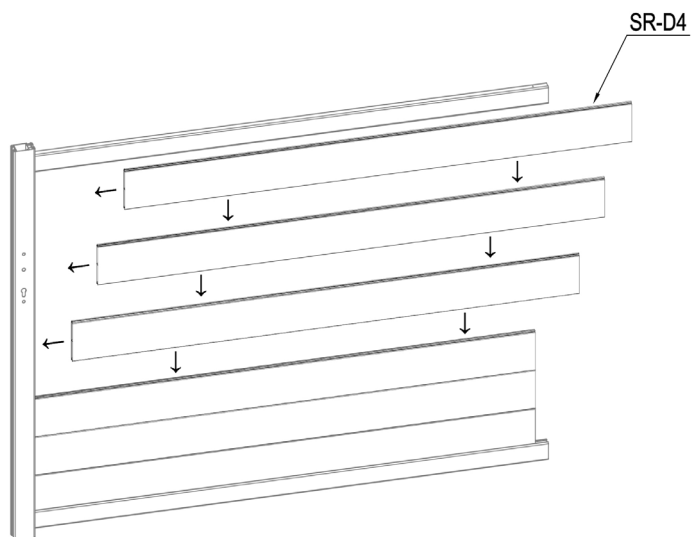

	SR-D4a	1
---	--------	---

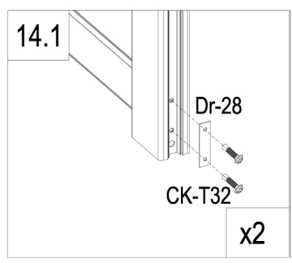
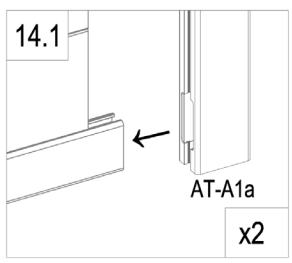
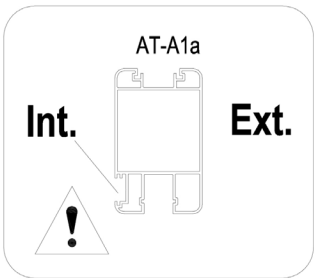
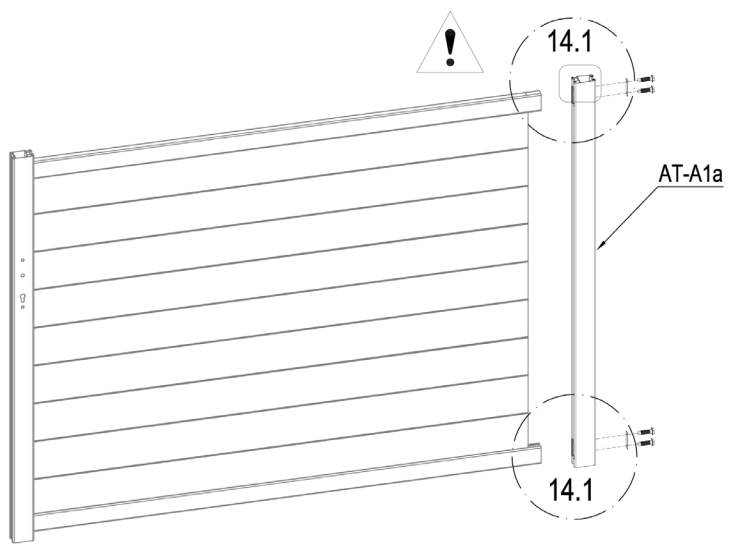

	SR-D4	8
---	-------	---



	AT-A1a	1
	Dr-28	2
	CK-T32	4

180°

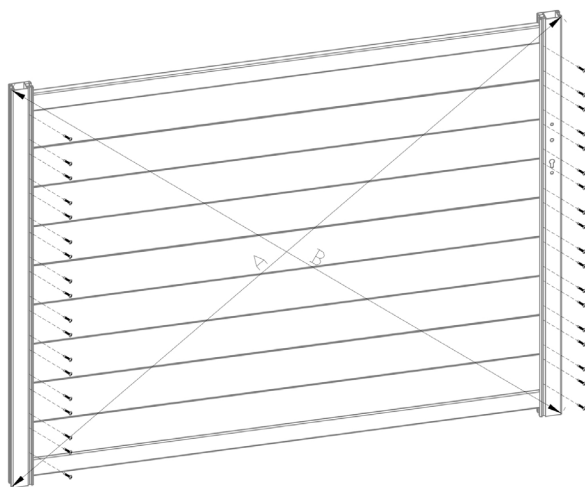

A=B

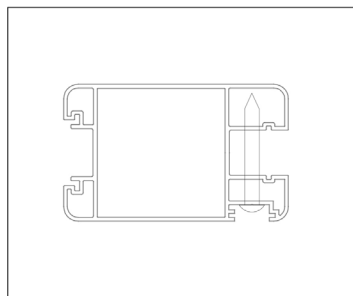
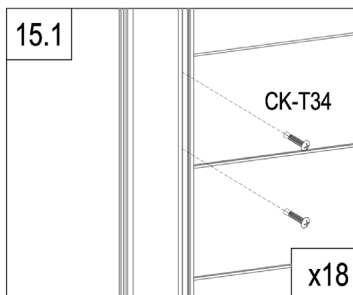

	CK-T34	36
---	--------	----

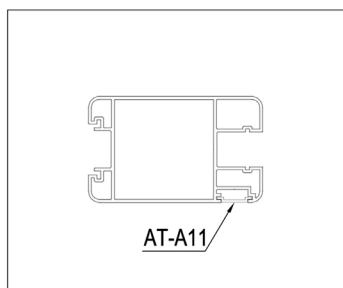
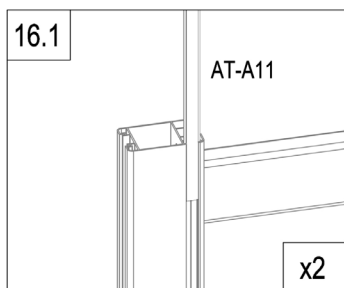
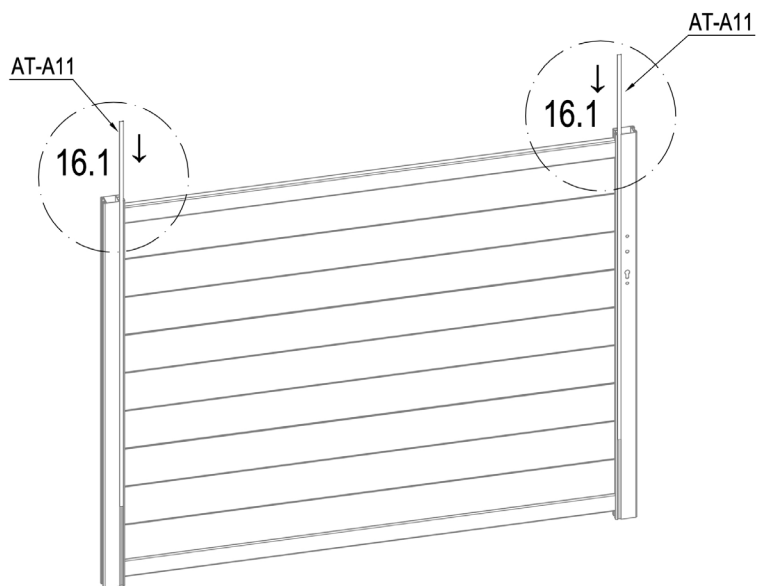

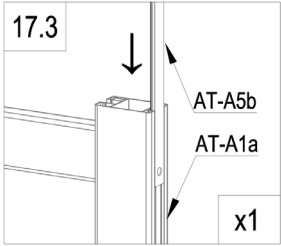
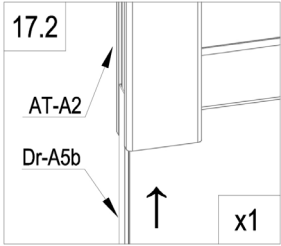
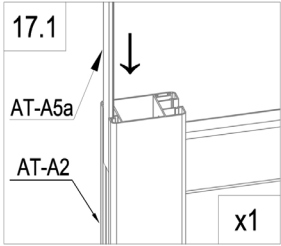
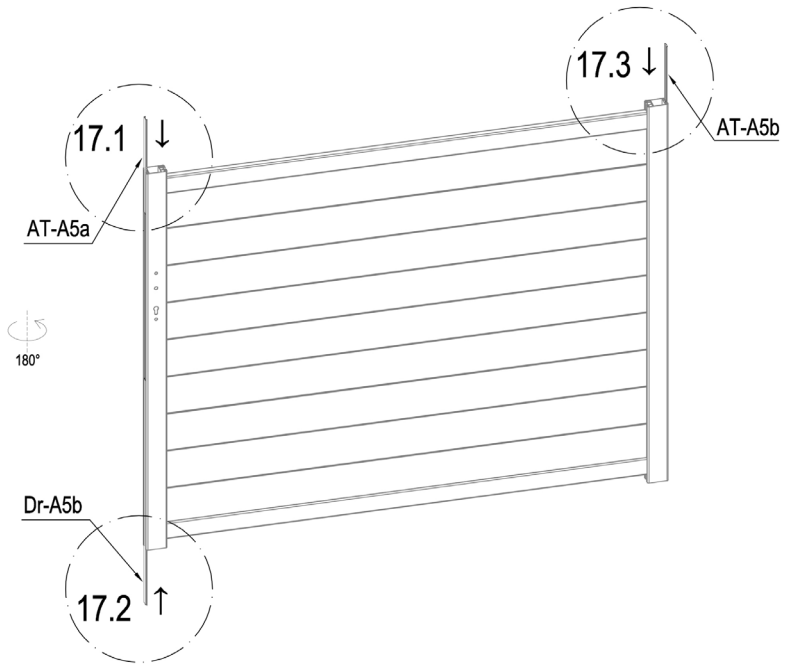

	AT-A11	2
---	--------	---



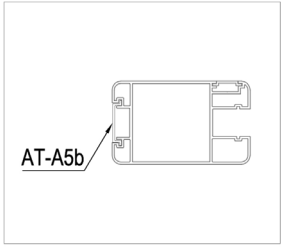

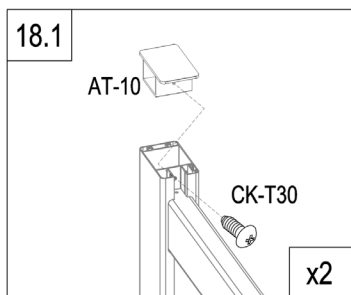
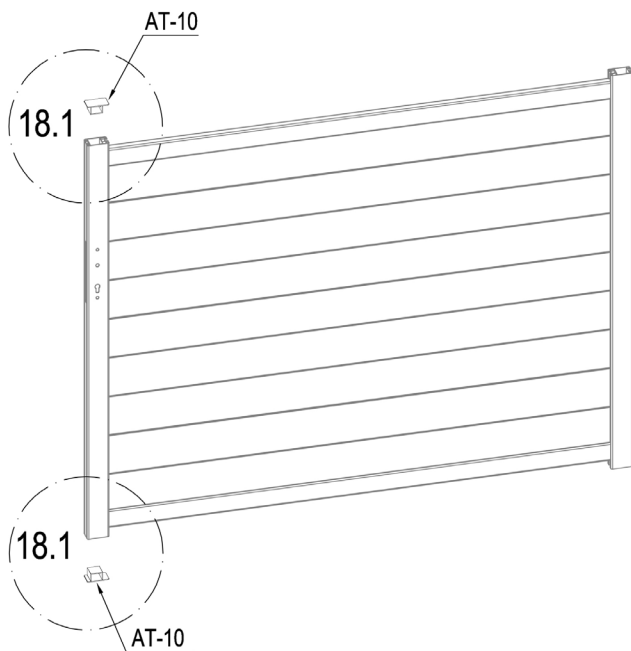
	AT-A5b	1
	AT-A5a	1
	Dr-A5b	1



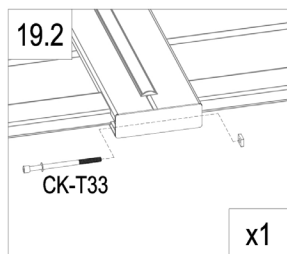
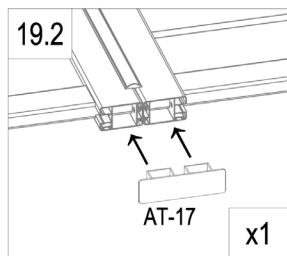
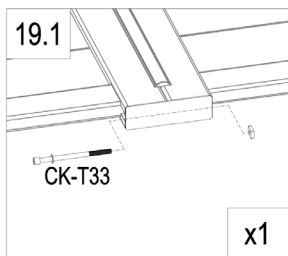
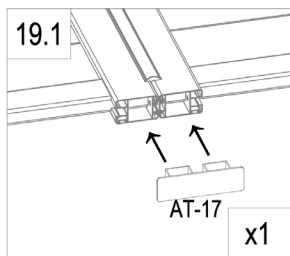
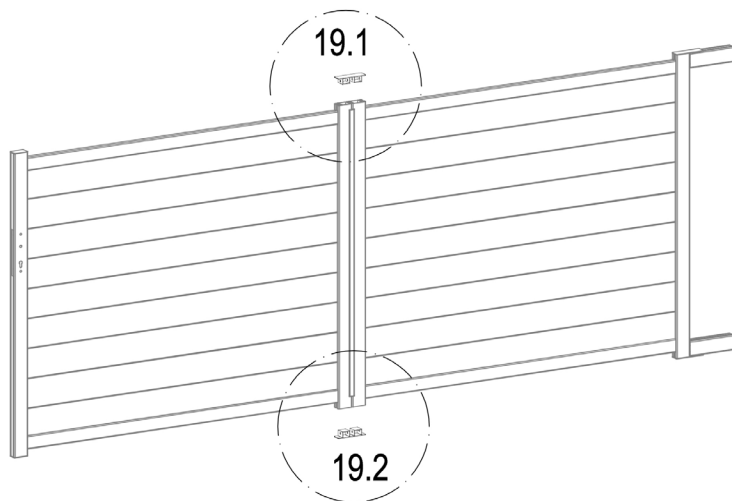

	AT-10	2
	CK-T30	2



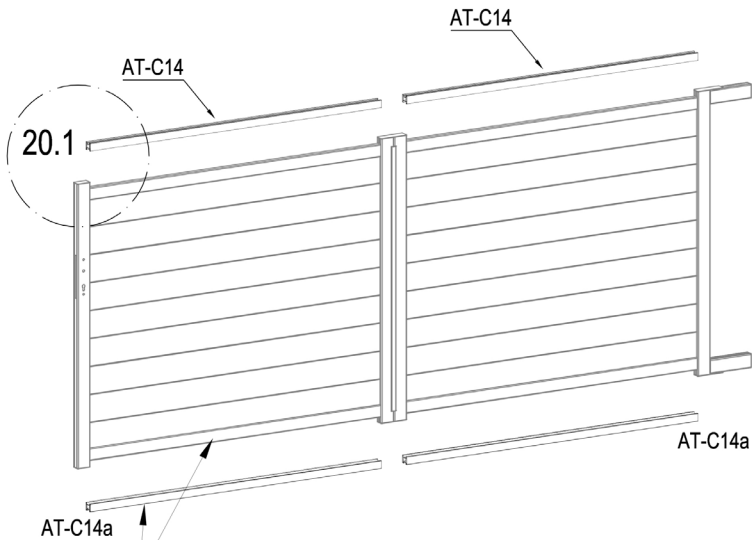

	AT-17	2
	CK-T33	2



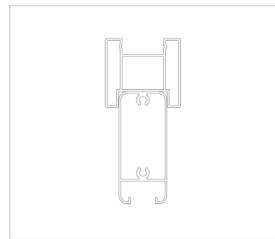
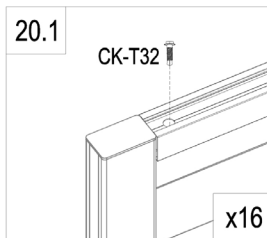
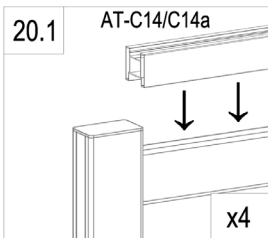

EN: These parts are made for connecting your gate's automation
 FR: Ces pièces sont faites pour relier l'automatisation de votre portail
 DE: Diese Teile sind für den Anschluss der Automatisierung Ihres Tores vorgesehen
 ES: Estas piezas están hechas para conectar la automatización de su puerta
 PT: Estas peças são feitas para ligar a automatização do seu portão
 IT: Queste parti sono realizzate per collegare l'automazione del vostro cancello
 NL: Deze onderdelen zijn gemaakt voor het aansluiten van de automatisering van uw poort.
 PL: Te części są wykonane do podłączenia automatyki bramy.

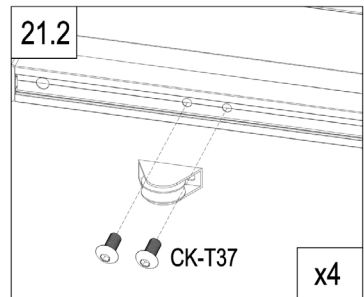
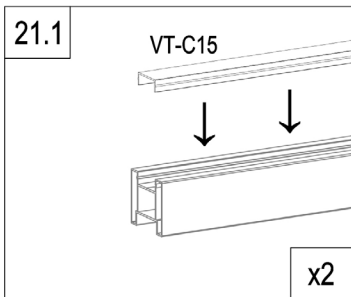
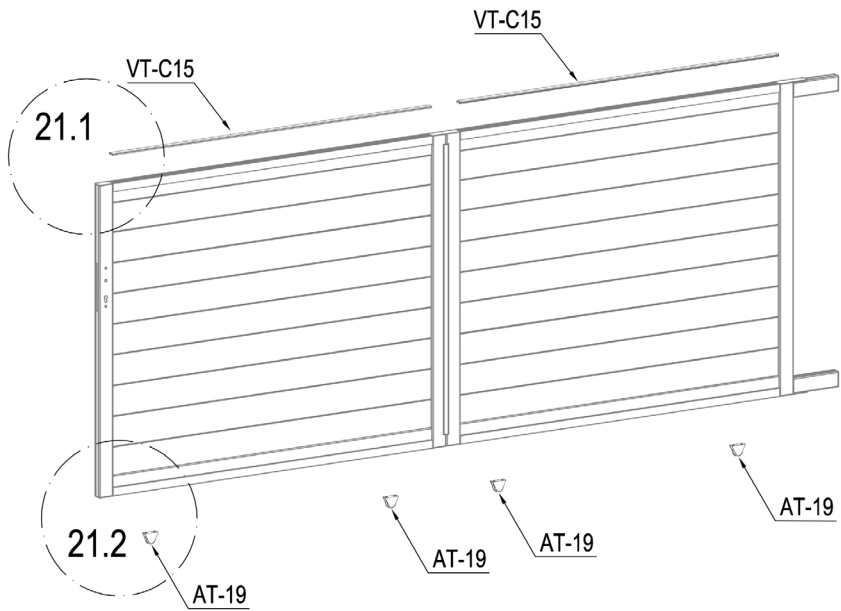

	AT-C14	2
	AT-C14a	2
	CK-T32	16



	VT-C15	2
	AT-19	4
	CK-T37	8

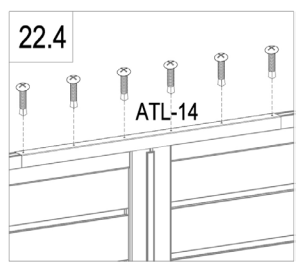
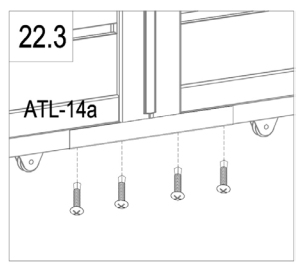
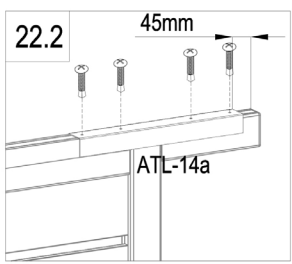
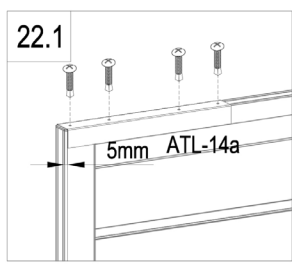
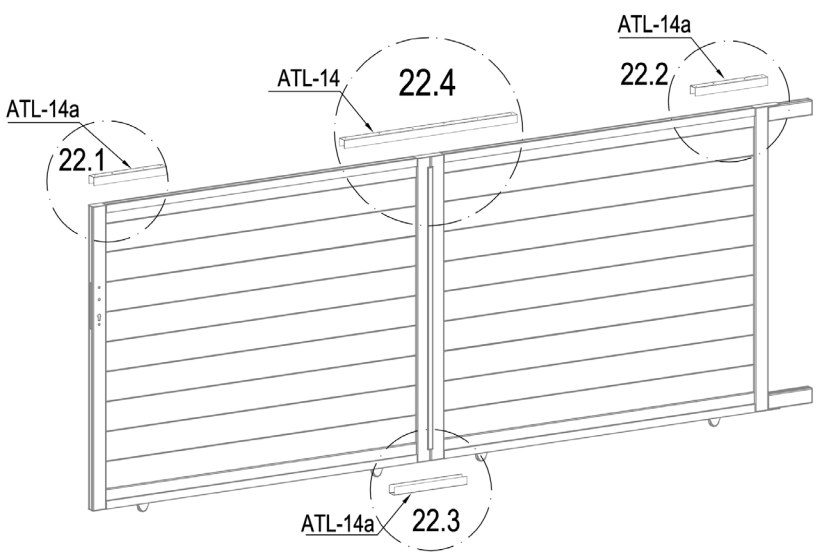

	ATL-14	1
	ATL-14a	3
	CK-T34	18

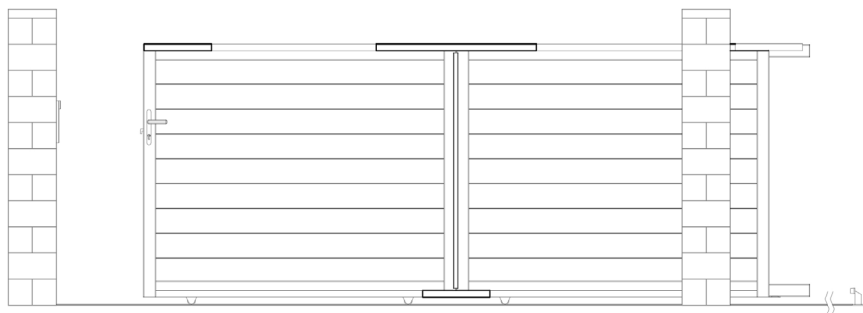

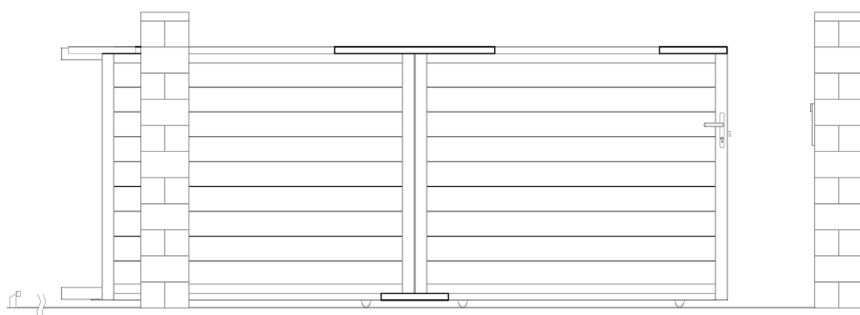

L : P23~28

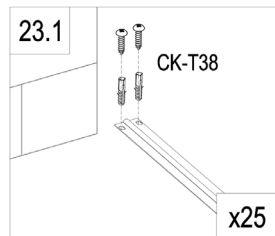
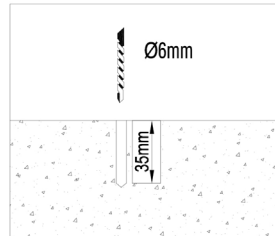
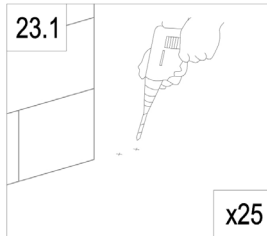
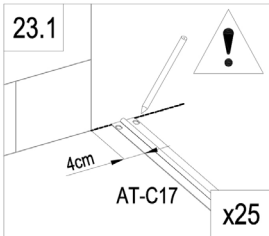
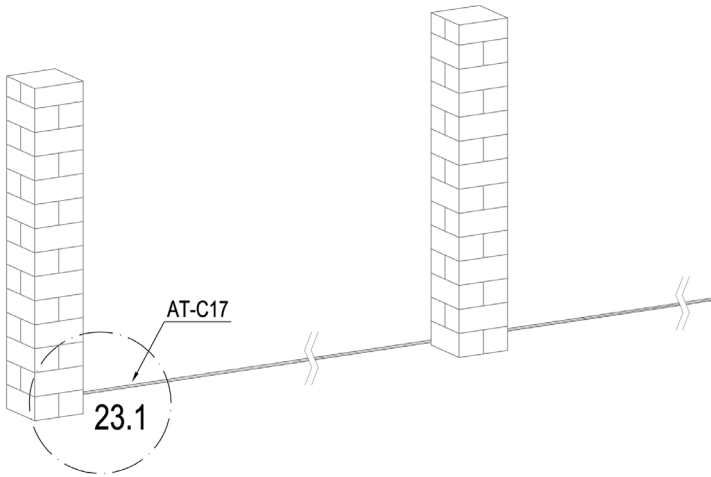

R : P29~34

L



	AT-C17	5
	CK-T38	50

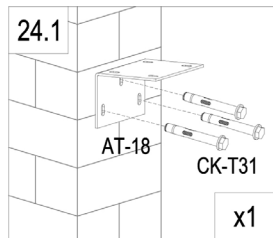
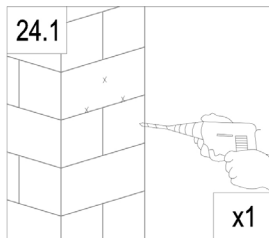
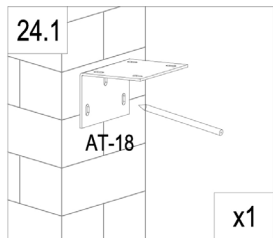
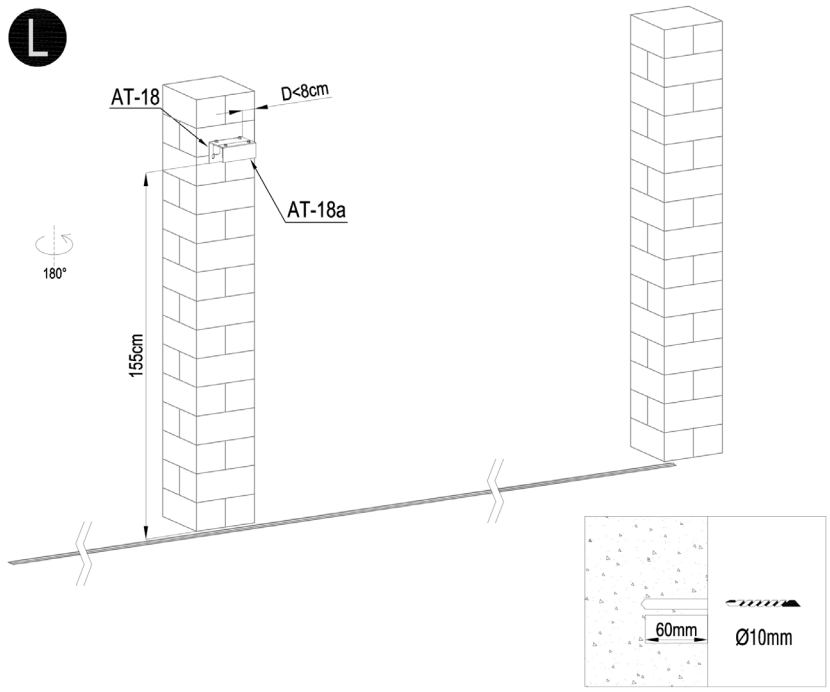

	AT-18	1
	AT-18a	1
	AT-20	4
	CK-T31	3

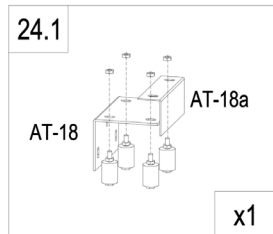
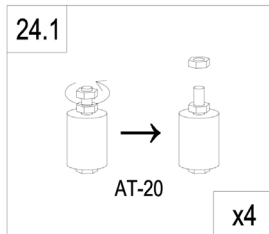

L

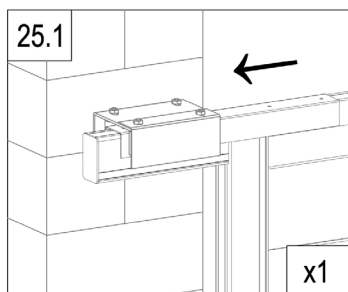
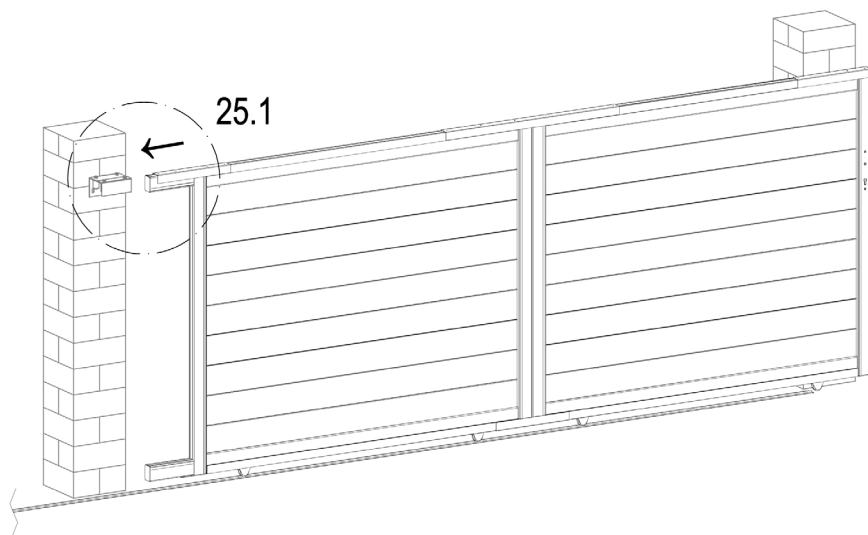

L

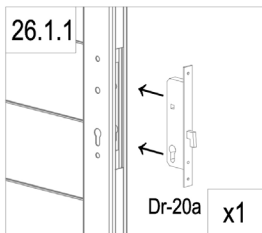
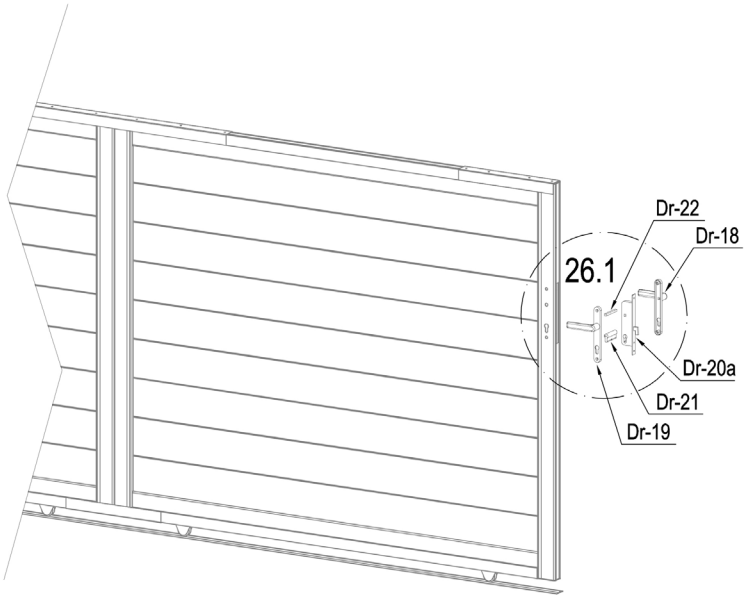

	Dr-20a	1
	Dr-21	1
	Dr-22	1
	Dr-25	1

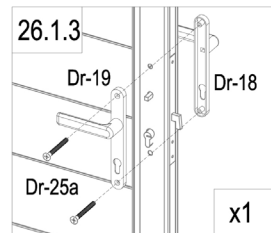
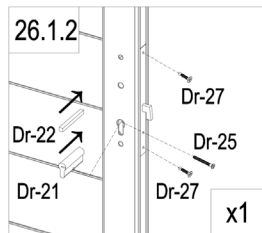

	Dr-18	1
	Dr-19	1
	Dr-25a	2
	Dr-27	2

L

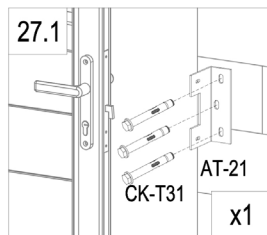
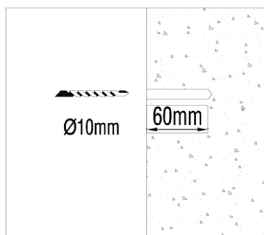
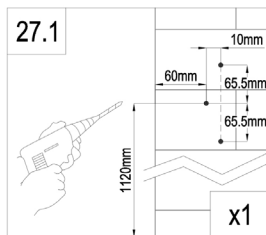
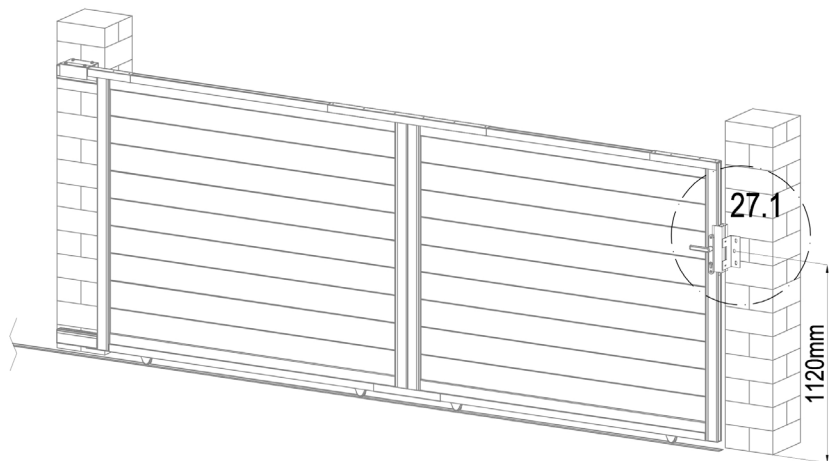

	AT-16	1
	AT-21	1
	CK-T36	2
	CK-T31	3
	AT-22J	3

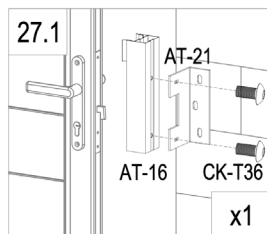
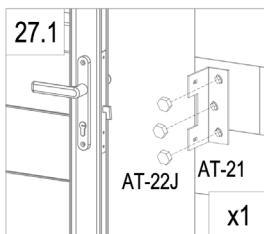

L

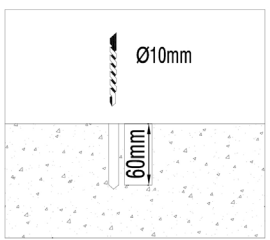
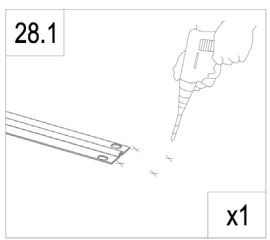
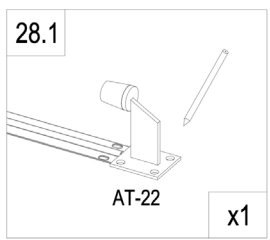
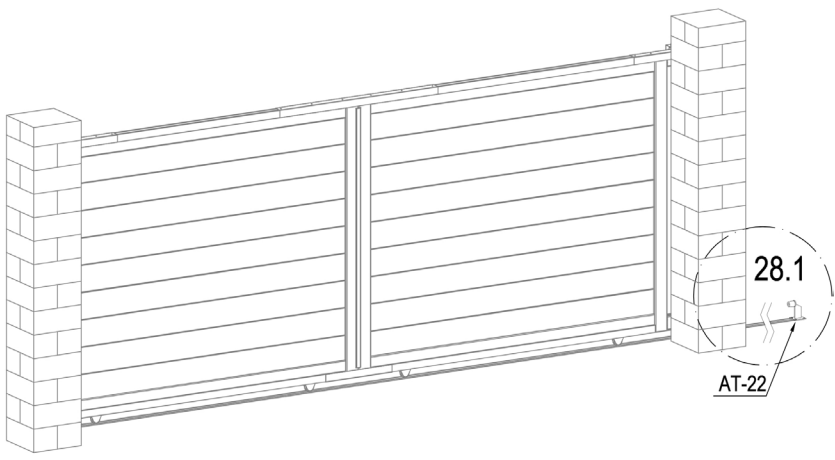

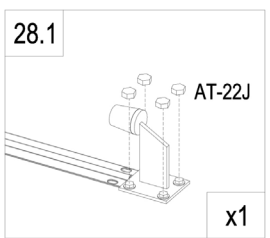
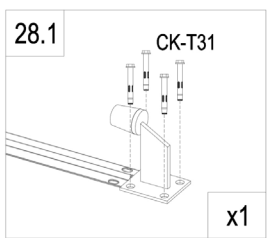

	AT-22	1
	CK-T31	4
	AT-22J	4

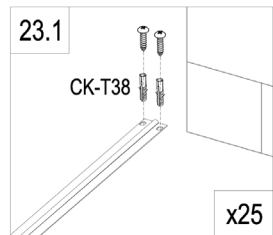
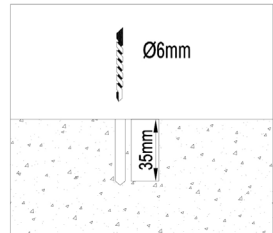
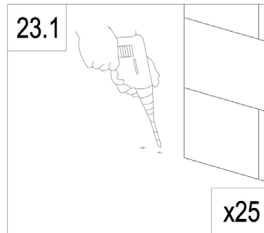
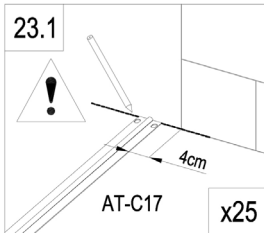
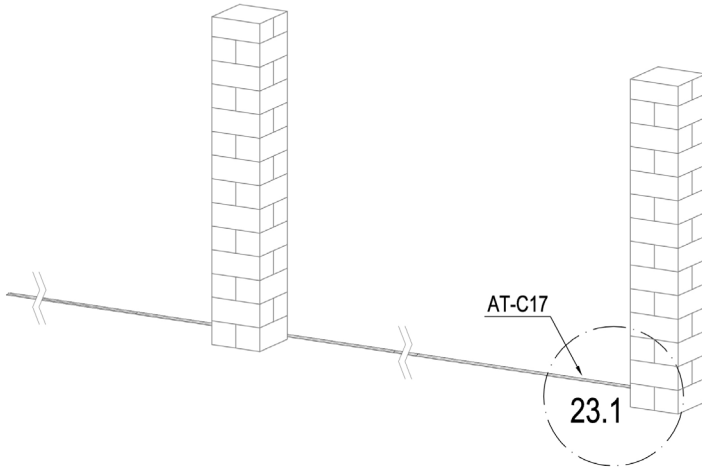

R



	AT-C17	5
	CK-T38	50

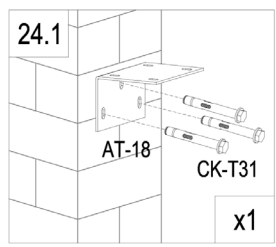
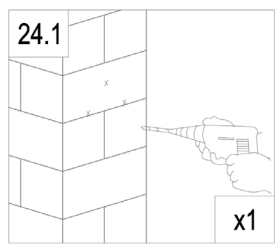
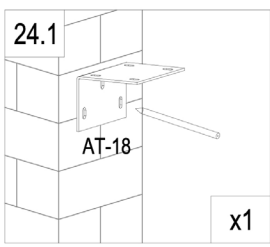
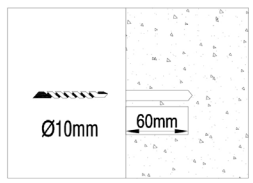
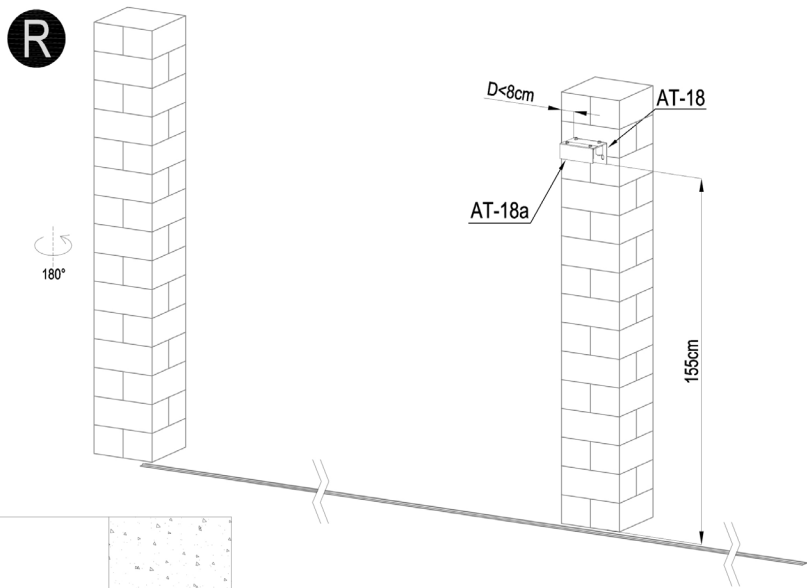

	AT-18	1
	AT-18a	1
	AT-20	4
	CK-T31	3

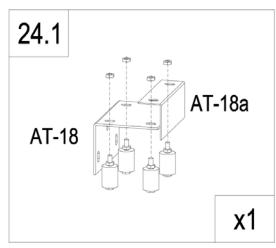
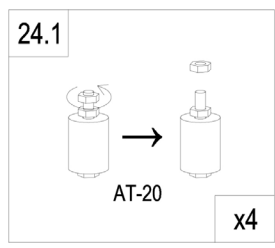

R

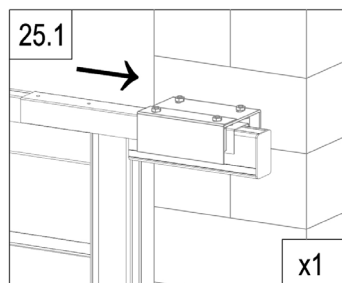
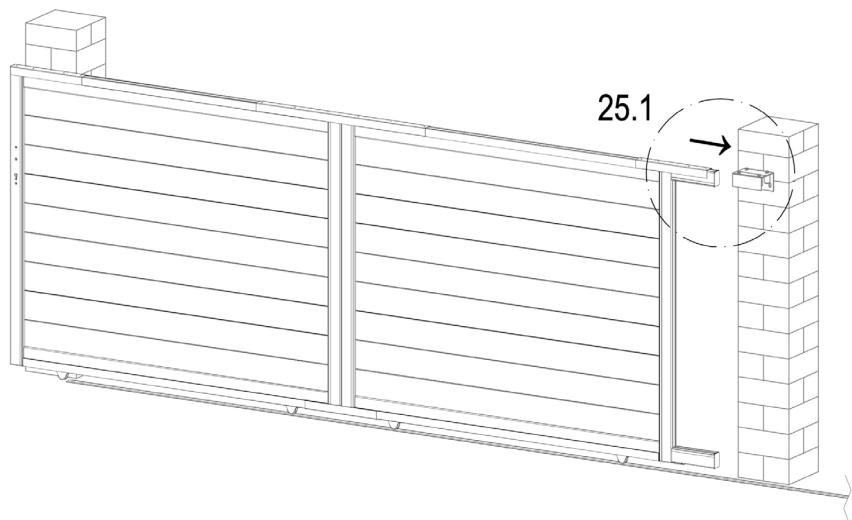

R

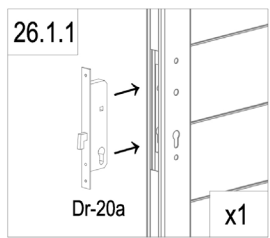
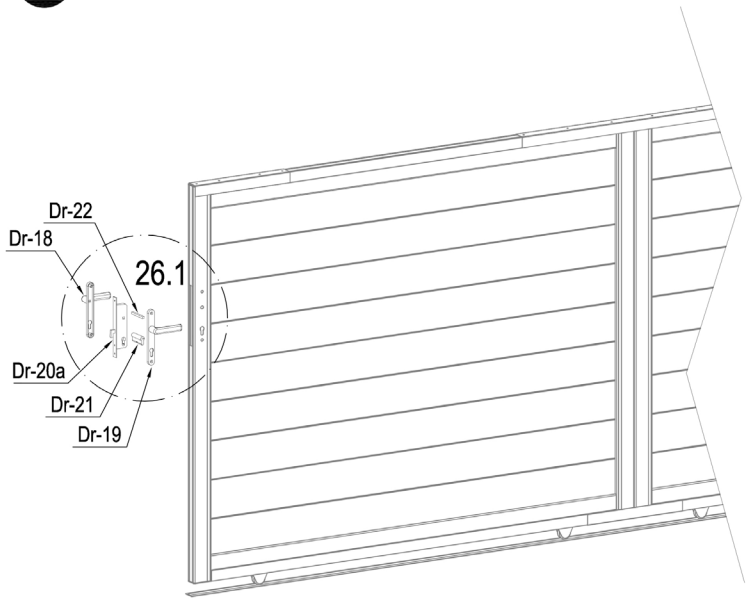

	Dr-20a	1
	Dr-21	1
	Dr-22	1
	Dr-25	1

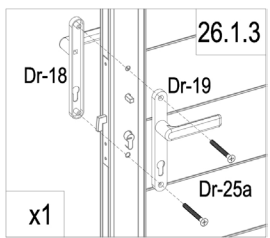
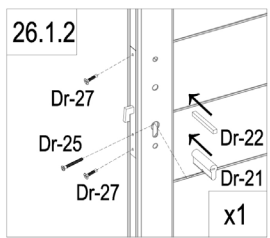

	Dr-18	1
	Dr-19	1
	Dr-25a	2
	Dr-27	2

R

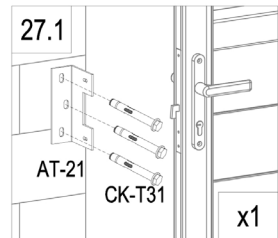
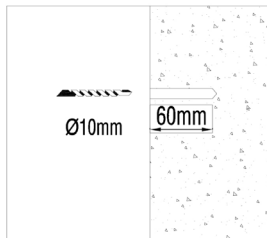
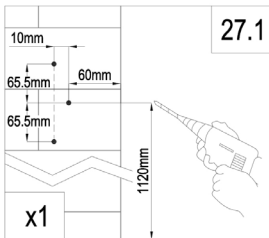
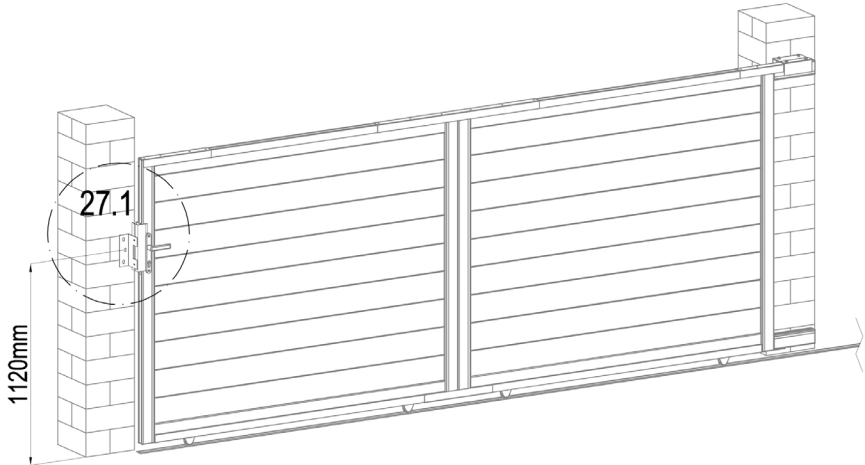

	AT-16	1
	AT-21	1
	CK-T36	2
	CK-T31	3
	AT-22J	3

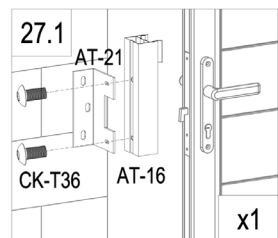
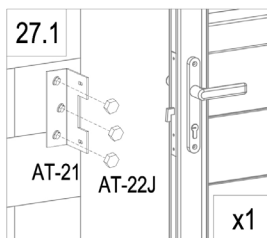

R

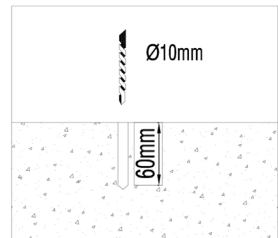
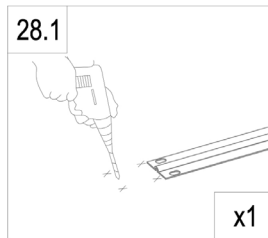
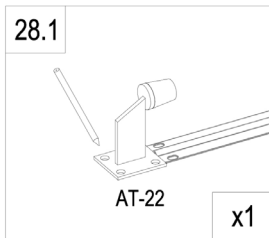
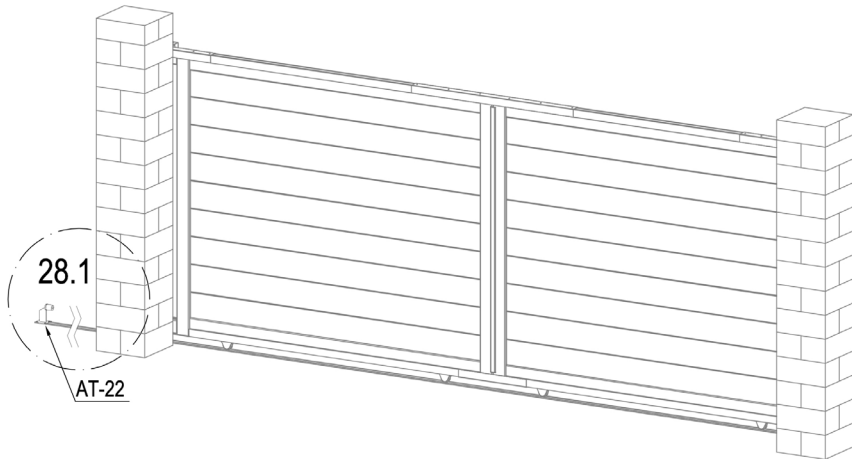

	AT-22	1
	CK-T31	4
	AT-22J	4

