

Installation Guide

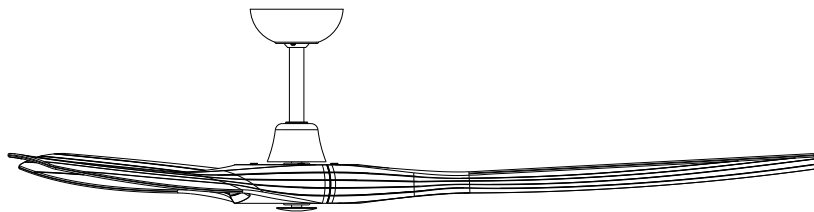

Morea



WHERE ARE WE

Calle Dinámica N°1, Pol. Ind. Santa Rita
08755 Castellbisbal, Barcelona SPAIN



CALL US

Ph +34 918 315 425
Fax +34 937 720 018



DOWNLOAD



faro@lorefar.com
www.faro.es



FOLLOW US



E Felicitades por la compra de su nuevo ventilador Faro Barcelona que le proporcionará, diseño, calidad y confort durante muchos años.

Estamos orgullosos de nuestro trabajo y apreciamos la oportunidad de suministrarle uno de los mejores ventiladores de techo disponibles. ¡Toca empezar a disfrutar de su ventilador de techo Faro Barcelona!

 El manual de contiene las instrucciones completas para instalar y operar con su ventilador de forma segura. Recuerde apretar firmemente todos los tornillos y hacer todas las conexiones correctamente.

C Felicitats per la compra del seu nou ventilador Faro Barcelona que li proporcionarà, disseny, qualitat i confort durant molts anys.

Estem orgullosos del nostre treball i apreciem l'oportunitat de subministrar-li un dels millors ventiladors de sostre disponibles.

Comenci a gaudir del seu ventilador de sostre Faro Barcelona!

 Els manuals contenen les instruccions completes per instal·lar i operar amb el seu ventilador de forma segura. Recordeu estrènyer fermament tots els cargols i fer totes les connexions correctament.

E Congratulations on the purchase of your new Faro Barcelona fan that will provide you, design, quality and comfort for many years.

We are proud of our work and appreciate the opportunity to provide one of the best ceiling fans available.

It's time to start enjoying your Faro Barcelona ceiling fan!

 The manuals contain the complete instructions for installing and operating with your fan safely. Remember to tighten all screws firmly and make all connections correctly

E Félicitations pour l'achat de votre nouveau ventilateur Faro Barcelona qui vous apportera design, qualité et confort pendant de nombreuses années.

Nous sommes fiers de notre travail et apprécions l'opportunité de fournir l'un des meilleurs ventilateurs de plafond disponibles. Il est temps de commencer à profiter de votre ventilateur de plafond Faro Barcelona!

 Le manuel d'utilisation contient les instructions complètes pour installer et

utiliser votre ventilateur en toute sécurité. N'oubliez pas de serrer toutes les vis fermement et de faire toutes les connexions correctement

I Congratulazioni per aver acquistato un ventilatore Faro Barcelona che le garantirà design, qualità e comfort per molto tempo. Siamo orgogliosi del nostro lavoro e apprezziamo molto che ci abbia dato l'opportunità di fornirle uno dei migliori ventilatori da soffitto disponibili nel mercato.

Cominci ad utilizzare il suo nuovo ventilatore da soffitto Faro Barcelona!

 Il manuale operativo contiene le istruzioni complete per installare ed utilizzare il suo ventilatore in totale sicurezza. Ricordi di avvitare bene tutti i bulloni e realizzare tutte le connessioni nella maniera corretta.

P Parabéns pela compra do seu novo ventilador de Faro Barcelona que lhe proporcionará design, qualidade e conforto por muitos anos. Estamos orgulhosos do nosso trabalho e apreciamos a oportunidade de fornecer um dos melhores ventiladores de teto disponíveis. É hora de começar a desfrutar do seu ventilador de teto Faro Barcelona!

 O manual de operação contém as instruções completas para instalação e operação com o seu ventilador com segurança. Lembre-se de apertar firmemente todos os parafusos e fazer todas as conexões corretamente.

D Herzlichen Glückwunsch zum Kauf Ihres neuen Faro Barcelona Ventilators, der Ihnen Design, Qualität und Komfort für viele Jahre bieten wird. Wir sind stolz auf unsere Arbeit und schätzen die Möglichkeit, Ihnen einen der besten Deckenventilatoren zu liefern. Es ist an der Zeit, Ihren Faro Barcelona Deckenventilator zu genießen!

 Die Betriebsanleitung enthält vollständige Anweisungen für die sichere Installation und den sicheren Betrieb Ihres Ventilators. Denken Sie daran, alle Schrauben fest anzuziehen und alle Verbindungen korrekt herzustellen.

N Gefeliciteerd met de aankoop van uw nieuwe Faro Barcelona ventilator. Deze zal u kwaliteit en confort bieden voor vele jaren.

Wij zijn trots op ons werk, en waarderen de mogelijkheid om u een van de beste beschikbare plafondventilatoren te leveren.

Geniet van uw nieuwe Faro Barcelona plafondventilator!

 De gebruikshandleiding bevat de volledige instructies voor de installatie en de veilige bediening van uw ventilator. Vergeet niet om alle schroeven stevig vast te draaien, en alle verbinding correct aan te sluiten.

E Συχαρητήρια για την αγορά του νέου σας ανεμιστήρα Faro Barcelona που θα σας προσφέρει νιζάιν, ποιότητα και άνεση για πολλά χρόνια. Είμαστε υπερήφανοι για την δουλειά μας και εκτιμούμε την ευκαιρία να σας προσφέρουμε έναν από τους καλύτερους ανεμιστήρες οροφής της αγοράς. Ήρθε η ώρα να απολαύσετε τον ανεμιστήρα οροφής Faro Barcelona!

 Το εγχειρίδιο λειτουργίας περιέχει τις πλήρεις οδηγίες για την εγκατάσταση και λειτουργία με τον ανεμιστήρα σας με ασφάλεια. Θυμηθείτε να σφίξετε καλά όλες τις βίδες και να κάνετε σωστά όλη τη συνδεσμολογία.

P Поздравляем вас с приобретением вентилятора Faro Barcelona нового поколения, который будет радовать вас своим дизайном, качеством и комфортом в течение многих лет.

Мы гордимся нашей работой и ценим возможность предоставить вам один из лучших потолочных вентиляторов. Пришло время начать наслаждаться потолочным вентилятором Faro Barcelona!

 Руководство по эксплуатации содержит полные инструкции по установке и безопасному использованию вашего вентилятора. Не забудьте крепко затянуть все винты и правильно установить все соединения.

C Gratulujeme vám k zakoupení vašeho nového ventilátoru Faro Barcelona, který vám poskytne design, kvalitu a komfort po mnoho let. Jsme hrdí na naši práci a vážíme si příležitosti poskytnout vám jeden z nejlepších stropních ventilátorů na trhu.

Je načase začít si užívat váš stropní ventilátor

Faro Barcelona!

 Provozní příručka obsahuje kompletní pokyny pro instalaci a bezpečný provoz vašeho ventilátoru. Nezapomeňte pevně dotáhnout všechny šrouby a vše správně připojit!

P Gratulujemy zakupu nowego wentylatora Faro Barcelona, który zapewni Ci design, jakość i komfort przez wiele lat. Jesteśmy dumni z naszej pracy i doceniamy możliwość zaoferowania jednego z najlepszych dostępnych wentylatorów sufitowych. Czas zacząć cieszyć się swoim wentylatorem Faro Barcelona!

 Instrukcja obsługi zawiera kompletne wskazówki dotyczące bezpiecznego instalowania i obsługi wentylatora. Pamiętaj, aby mocno dokręcić wszystkie śruby i prawidłowo wykonać wszystkie połączenia!

B Поздравления за закупването на новия ventilator от Faro Barcelona, който ще ви осигури дизайн, качество и удобство в продължение на много години. Гордеем се с нашата продукция и оценяваме възможността да ви предоставим един от най-добрите таванни вентилятори. Време е да започнете да се наслаждавате на таванния ventilator на Faro Barcelona!

 Ръководството за експлоатация съдържа пълните инструкции за безопасно монтиране и работа с вашия ventilator. Не забравяйте да затегнете здраво всички винтове и да свържете правилно всички връзки.

S Blahozeláme k nákupu vášho nového ventilátora Faro Barcelona, ktorý vám poskytne dizajn, kvalitu a komfort po mnoho rokov.

Sme hrdí na našu prácu a oceňujeme príležitosť poskytnúť jeden z najlepších stropných ventilátorov. Je čas začať si užívať váš stropný ventilátor Faro Barcelona!

 Návod na obsluhu obsahuje úplné pokyny na inštaláciu a bezpečnú prevádzku vášho ventilátorom. Nezapodniťe pevné utiahnuť všetky skrutky a urobiť všetky pripojenia správne.

Technical Specifications

Speeds	A	W	RPM	CFM	M ³ MIN	Power	
I - low	0,06	3	58			V	220-240
II	0,09	7	105			Hz	50/60
III	0,13	12	131				
IV	0,17	17	148				
V - High	0,33	38	195	7473	211.7		

sizes mm / inch

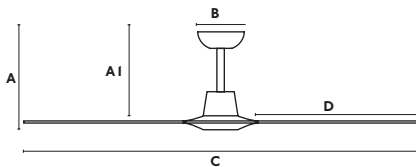

A	AI	B	C	D
290 / 11.41"	270 / 10.62"	∅148/5.82"	∅1520/60"	750 / 29.52"

Weight

kg	5,45
lb	12.01

3



Ref. 33511

Motor

Material	Steel
Finished	Brown

Blades

Material	ABS
Finished	Brown



Ref. 33519

Motor

Material	Steel
Finished	Brown

Blades

Material	ABS
Finished	Maple



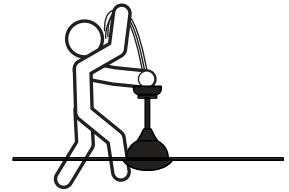
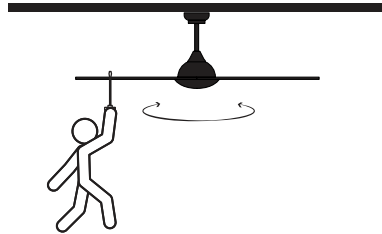
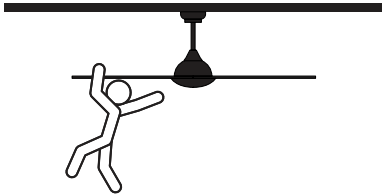
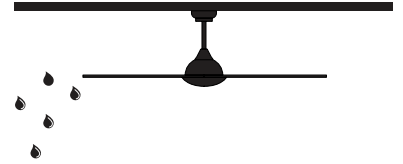
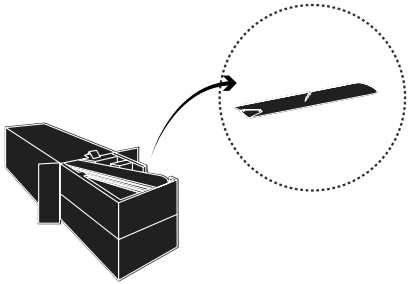

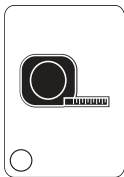
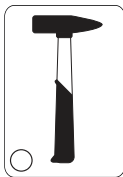
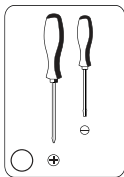
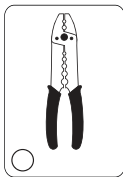
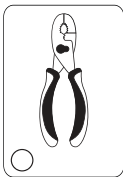

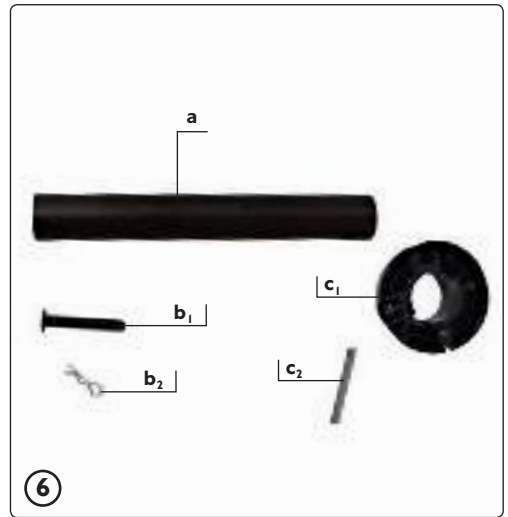
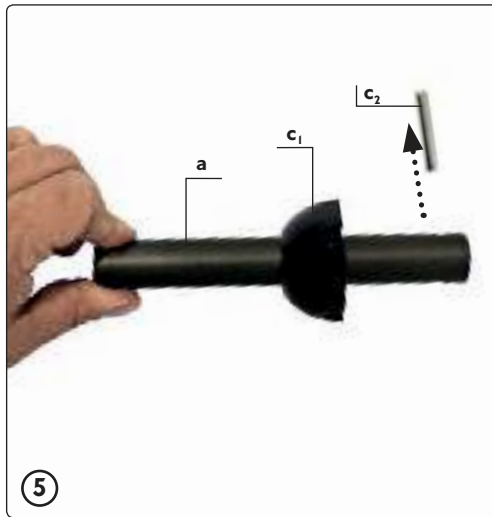
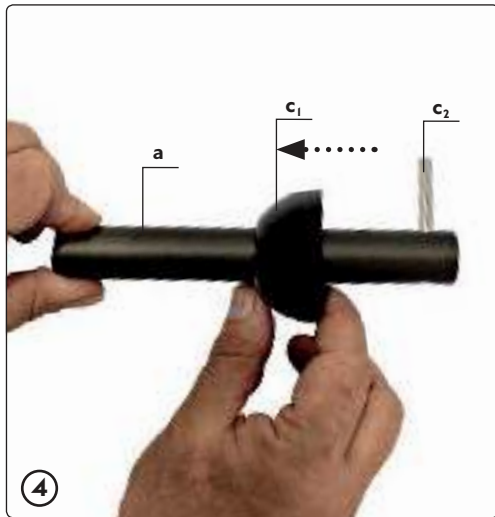
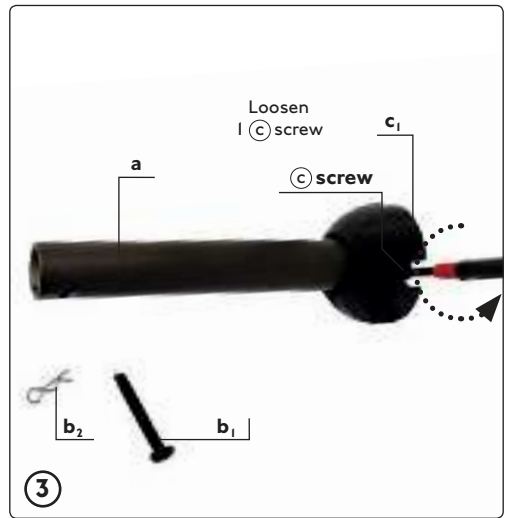
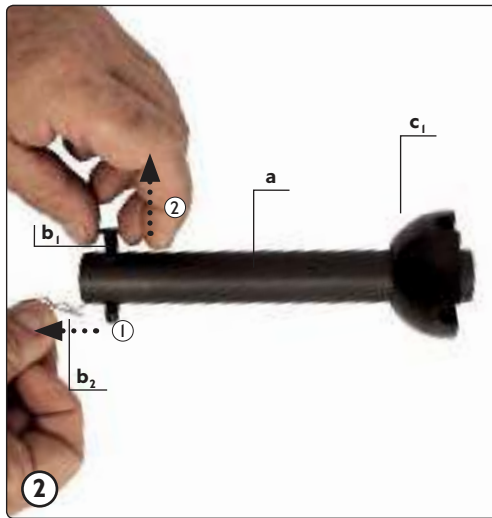
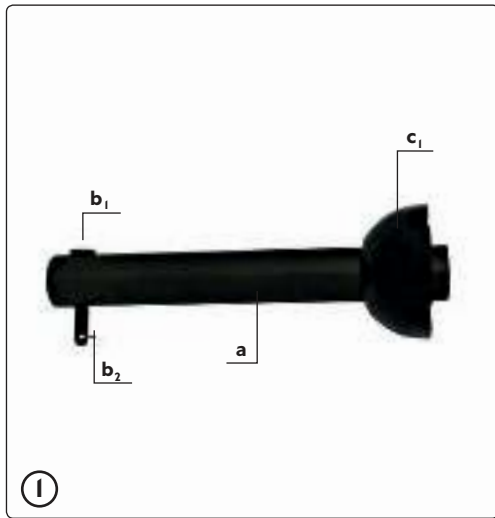

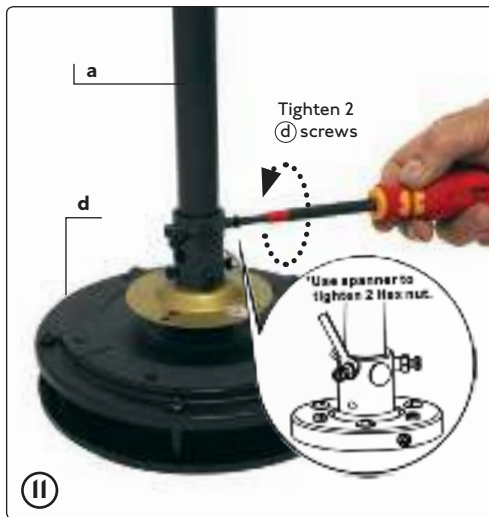
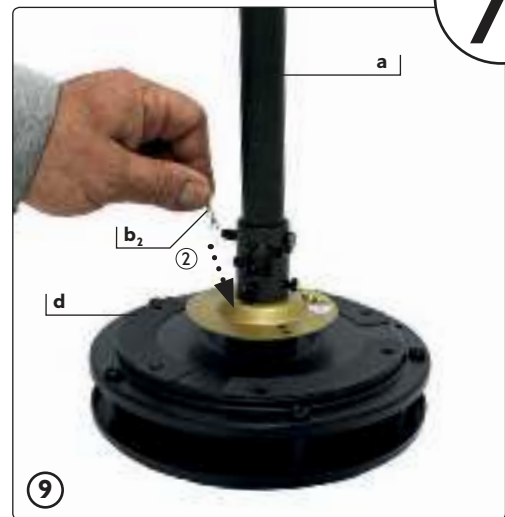
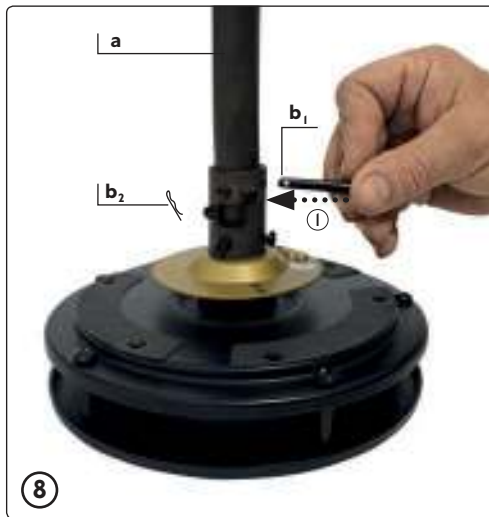

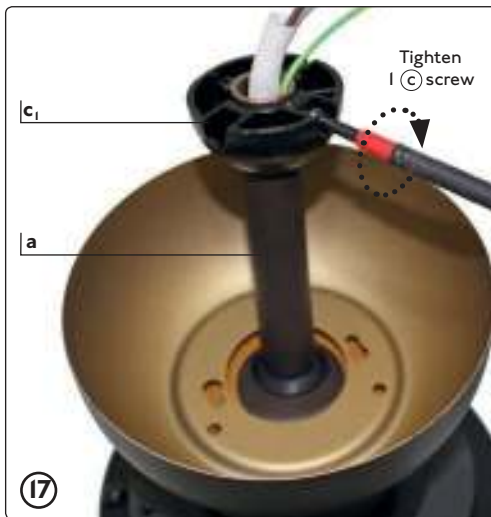
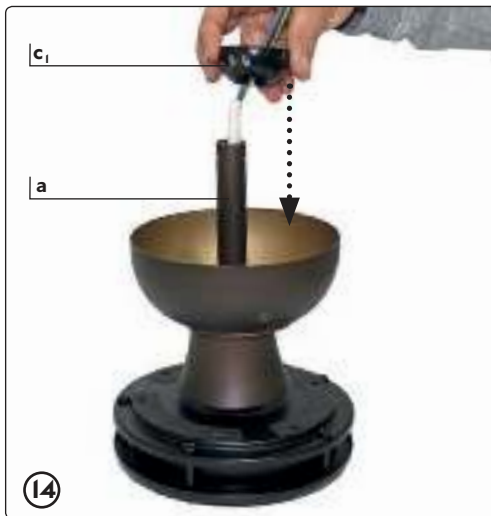



19

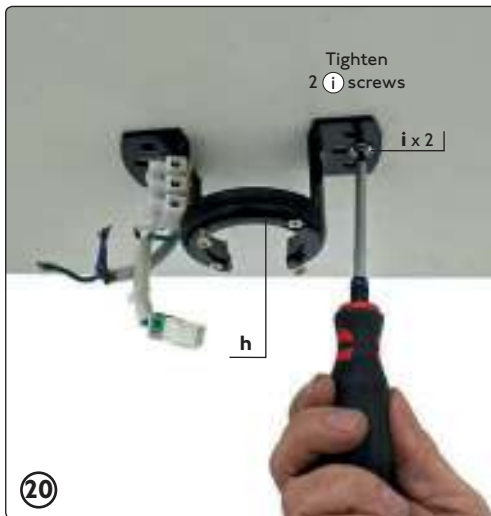

20

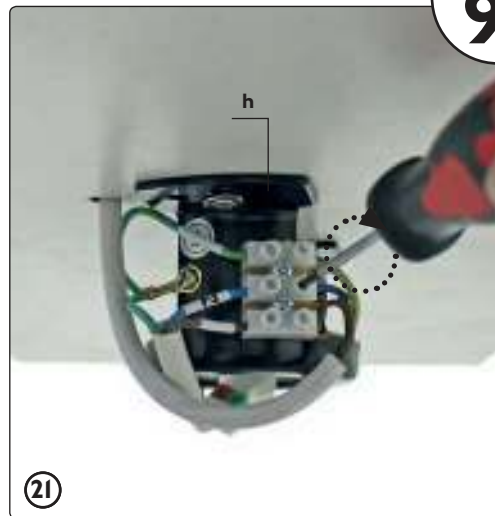

21



From House

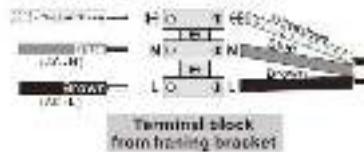

JST

Receiver

From Fan

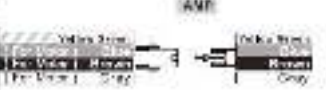

Antenna

L: marrón, marrón, brown, marron, castanho, braun, bruin, καφέ, коричневый, hnědá, brązowy, кафяв, hnedý

N: azul, blau, blue, bleu, blu, azul, marrone, blauw, μπλε, синий, modrá, niebieski, син, modrý

⊕: amarillo-verde, groc-verd, yellow-green, jaune-vert, giallo-verde, verde-amarelo, gelbgrün, gell-groen, κίτρινο-πράσινο, желто-зеленый, žlutozelená, żółto-zielony, жълто-зелен, žltozelená



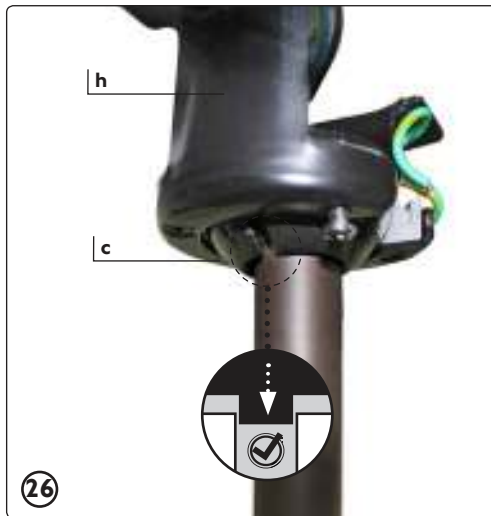
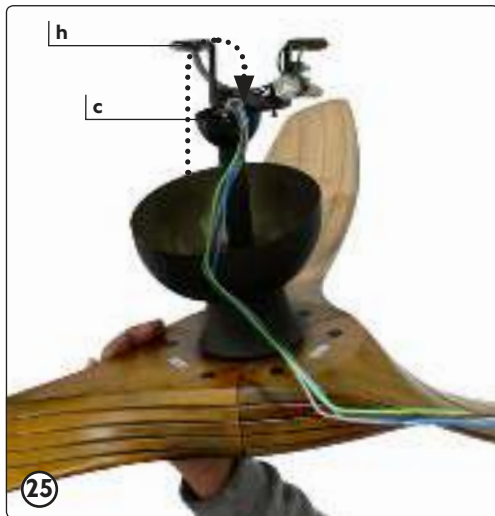
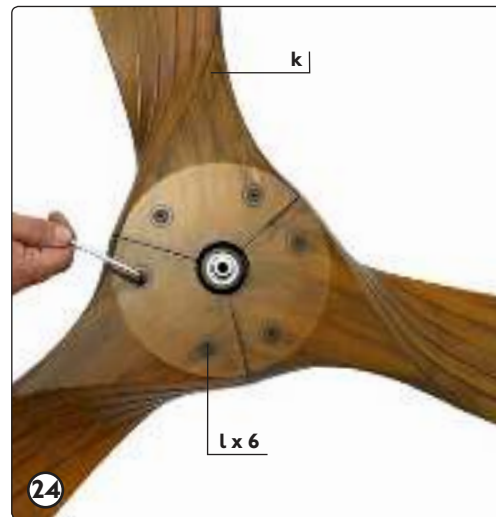
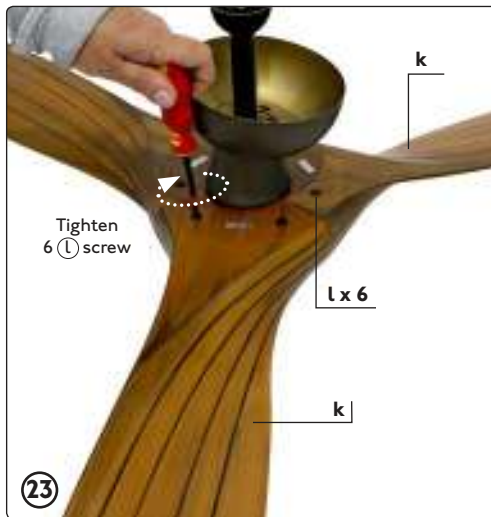
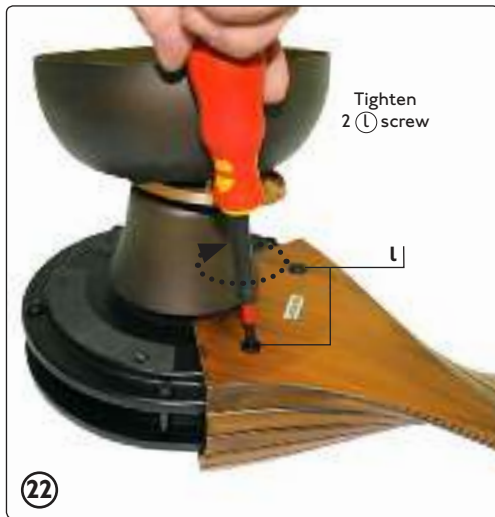

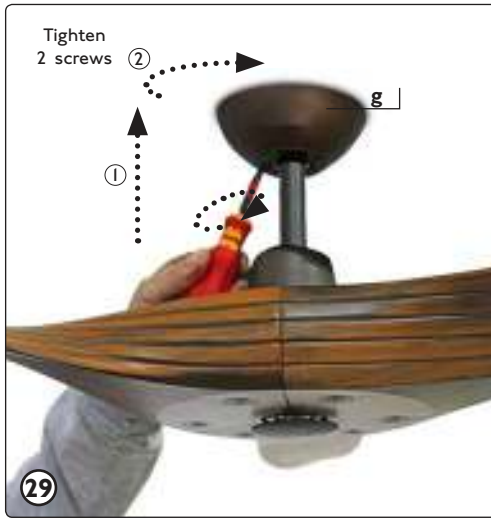

Remote control

ESPAÑOL

BOTONES DE MANDO DEL TRANSMISOR:

- 1- Velocidad
- 2- Función inversa
- 3- Encendido y apagado del ventilador
- 4- Programable: Funcionará durante 1h, 4h, 8h

CATALÀ

BOTONS DEL COMANDAMENT

- 1- Velocitat
- 2- Funció inversa
- 3- Encen i apaga el ventilador
- 4- Programable: Funcionará durant 1h, 4h, 8h

ENGLISH

OPERATIONS WITH THE TRANSMITTER

- 1- Fan speed
- 2- Reverse function
- 3- On off for fan
- 4- With Programmer: It will works for 1h, 4h, 8h

FRANÇAIS

BOUONS DE L'EMETTEUR

- 1- Vitesses
- 2- Interrupteur a sens inverse pour changer la direction du tour du ventilateur
- 3- On/off ventilateur
- 4- Avec Programmeur: Fonctionne pendant 1h, 4h, 8h

ITALIANO

BOUTONS DE L'EMETTEUR :

- 1- Velocità
- 2- Senso di rotazione del ventilatore, in avanti o indietro.
- 3- On/off ventola
- 4- Programmabile. Finziona per 1t, 4t, 8t

PORTUGÊS

BOTÕES NO TRANSMISSOR

- 1- Velocidades da ventoinha
- 2- Controla a direcção de rotação, para a frente ou para trás
- 3- Começando marcha e desemprego do ventonhia
- 4- Programável: Funciona por 1h, 4h, 8h

NEDERLANDS

BEDIENINGSKNOPPEN OP DE ZENDER

- 1- Snelheid van de ventilator
- 2- Inverse functie
- 3- Onn/off Verlichting
- 4- Programmeerbare: Werkt voor 1t, 4t, 8t

DEUSTCH

TASTEN AM SENDER

- 1- Ventilatorgeschwindigkeit
- 2- Umkehrfunktion
- 3- On/off ventilator
- 4- Programmierbar: Arbeitet für 1s, 4s, 8s

ΕΛΛΗΝΙΚΗ

ΠΛΗΚΤΡΑ ΕΝΤΟΛΩΝ ΤΗΛΕΧΕΙΡΙΣΤΗΡΙΟΥ

- 1- Ταχύτητα
- 2- Αντίστροφη συνάρτηση
- 3- Εντός και εκτός του ανεμιστήρα
- 4- Προγραμματισμένη: Λειτουργεί για 1, 4, 8 ώρες

РУССКИЙ

КНОПКИ УПРАВЛЕНИЯ ПЕРЕДАЮЩЕГО УСТРОЙСТВА

- 1- Скорость
- 2- Положение переключателя скоростей на период жаркой или холодной погоды
- 3- Позиция выключения вентилятора
- 4- Программируемые: Работает 1, 4, 8 часов

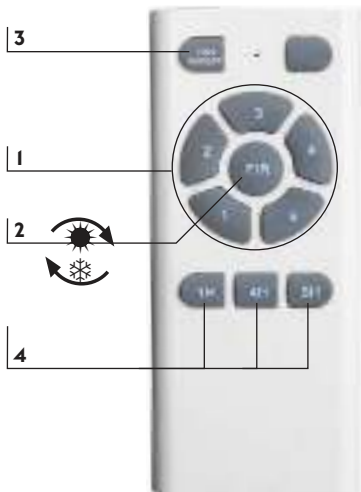



Sync 1 remote control

ČESKY

OVĽADACÍ TLAČÍTKA VYSÍLAČE

- 1- Otáčky ventilátoru
- 2- Inverzní funkce
- 3- On/off ventilátoru
- 4- Programmable: Pracuje na 1, 4, 8 hodin

POLSKI

PRZYCISKI DO STEROWANIA NA NADAJNIKU:

- 1- Prędkości
- 2- Funkcja odwrotna
- 3- On/off wentylatora
- 4- Programowanie: Działa przez 1, 4, 8 godzin

БЪЛГАРСКИ

БУТОНИ ЗА УПРАВЛЕНИЕ НА ПРЕДАВАТЕЛЯ:

- 1- Скорост
- 2- Обратна функция
- 3- On/off вентилатора
- 4- Програмируем: Работи за 1, 4, 8 часа

SLOVENČINA

TLAČIDLÁ NA VYSIELAČI

- 1- Rýchlosť
- 2- Inverznej funkcie
- 3- On/off ventilátora
- 4- Programovateľný: Pracuje na 1, 4, 8 hodiny





Fan not sync

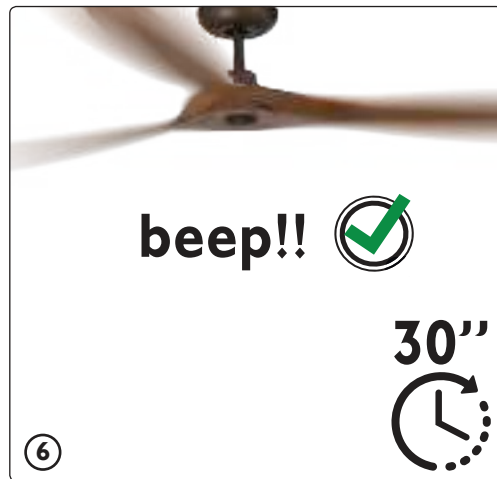
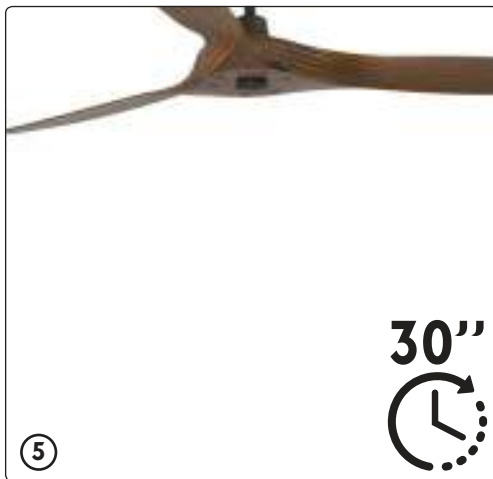
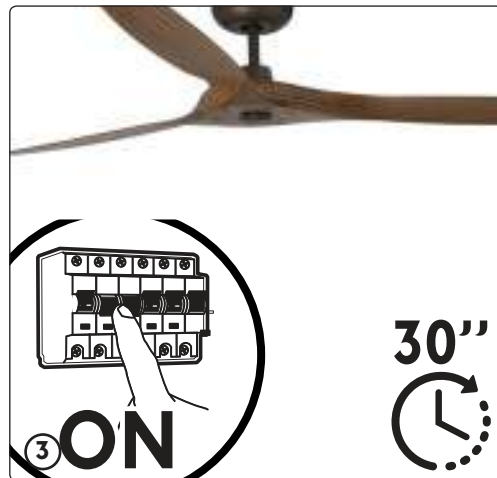





Sync remote controls with 2 or more fans

Fan 1

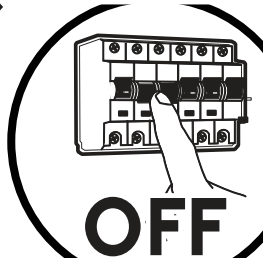
beep!!



OFF

①

Fan 2

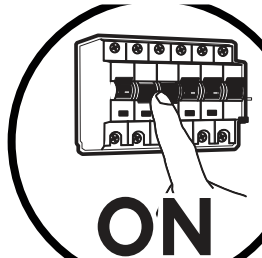

ON

②

Fan 2

PUSH





FAN ON/OFF

5"

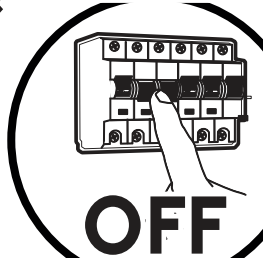

③

beep!!



OFF

④

Fan 3

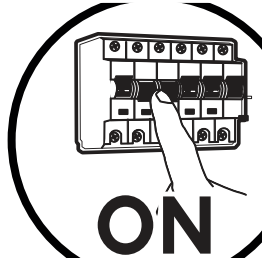

ON

⑤

Fan 3

PUSH



FAN ON/OFF

5"



⑥

