

KLEWE
SISTEMASOLARE

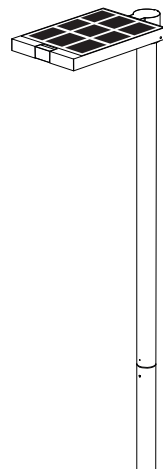

LINK



MADE IN CHINA

DESIGNED IN ITALY BY FRANCO PAGLIARINI
WWW.KLEWESOLAR.EU

VERSION 1.0 

1.

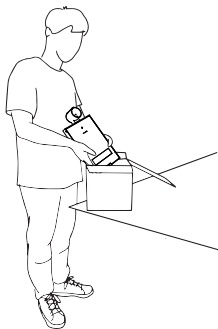

2.

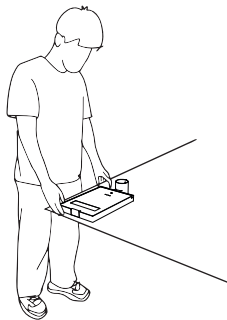

5A.

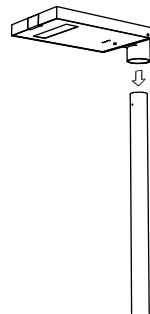
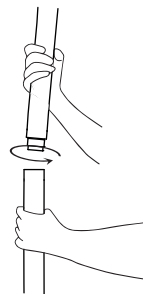
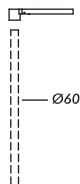

3.

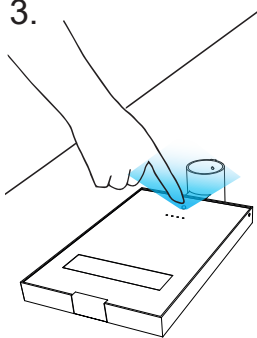

4.

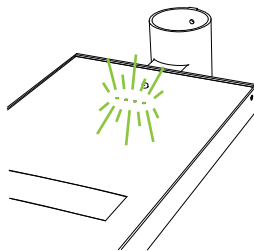

5B.

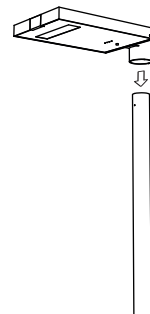
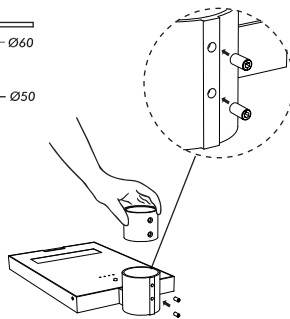
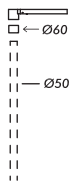

5B.

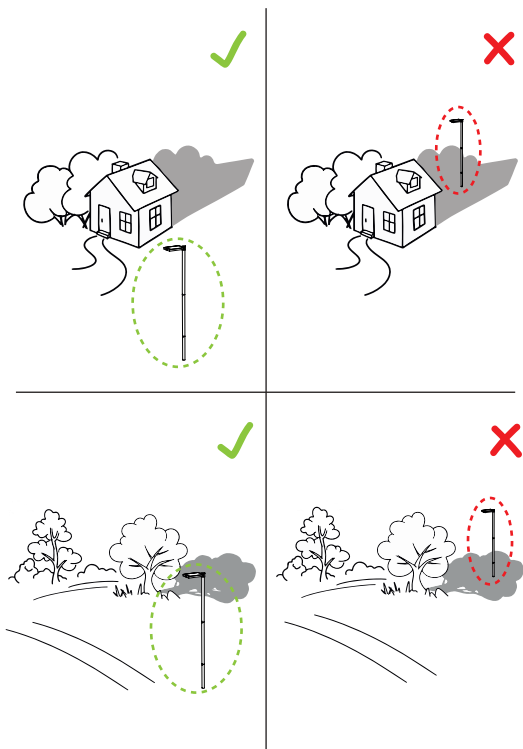
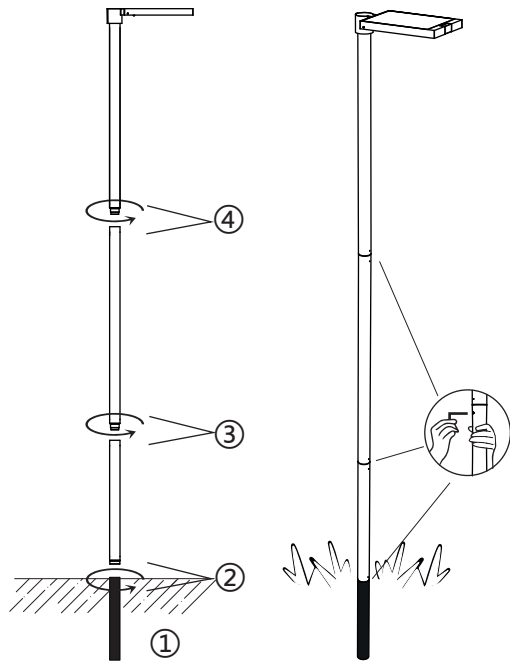

< 50LUX

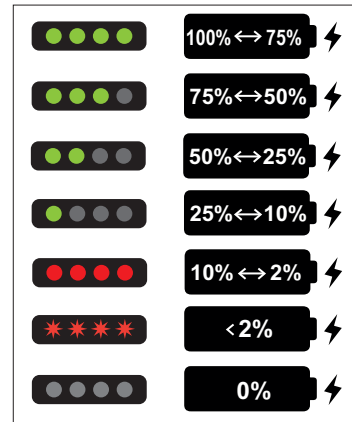
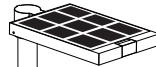
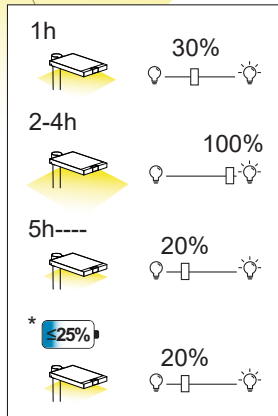
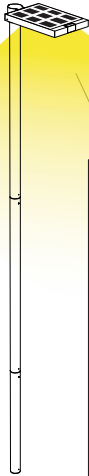

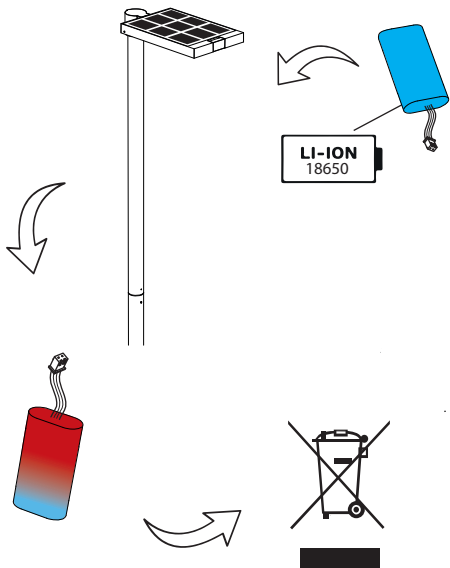
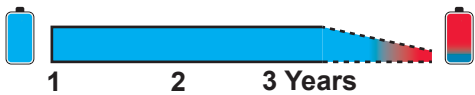

1.

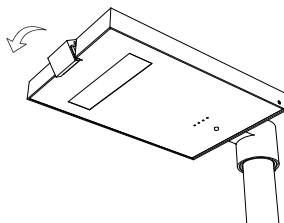

2.

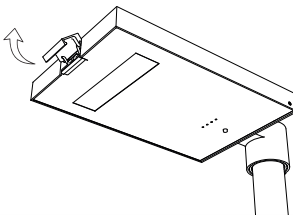

3.

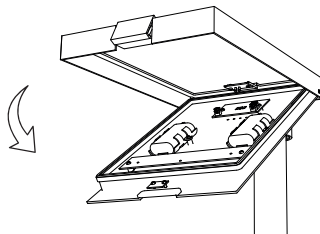

4.

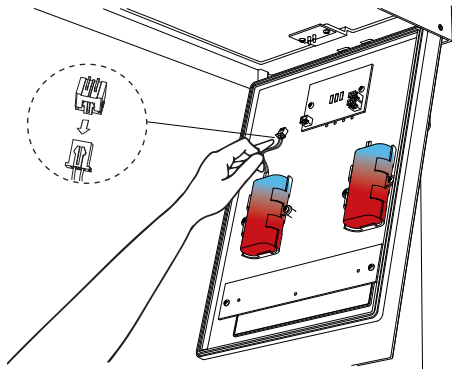

5.

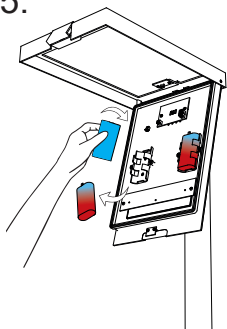

6.

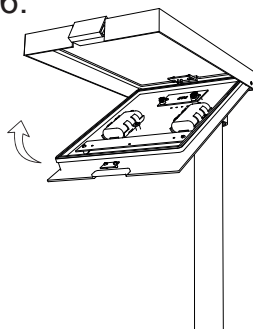

	IP65
	8-10h
	34-36h
Watt	5
	8800 mAh
	9W 7V
	3000K
CRI	>80

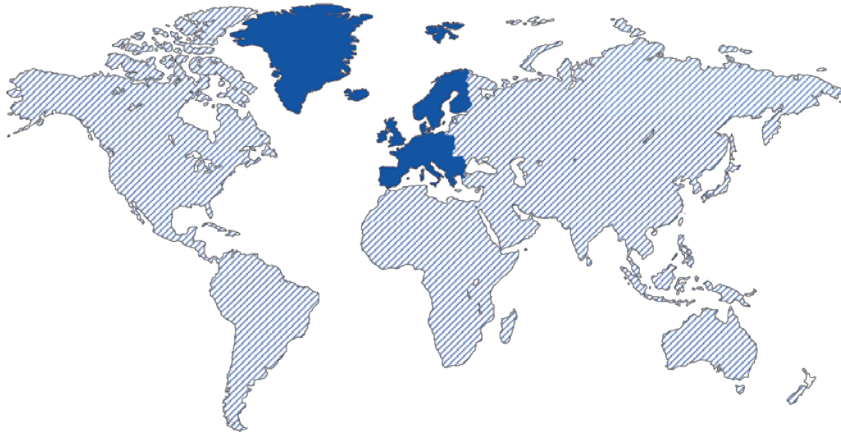

 **Europe:**



www.klewesolar.eu

 **Worldwide:**



www.klewesolar.com



info@eddsrl.eu



info@klewesolar.com